



DLP PROJECTION TV OWNER'S MANUAL



Money Isn't All You're Saving

Please read this manual carefully before operating your set.
Retain it for future reference.
Record model number and serial number of the set.
See the label attached on the back cover and quote this
information to your dealer when you require service.

Model number :
Serial number :

P/NO : 3828VA0476T (MB03CC, 100E/100X TX, 486-395C)@

Contents

Installation	3
Location and function of controls	4
Remote control handset	
Battery installation	
Front panel / Rear panel	
Basic operation	8
On and off / Programme selection	
Volume adjustment / Quick view / Mute function	
On screen language selection (option)	
On screen menus	9
Menu selection	
SETUP menu	10
Auto programme tuning	
Manual programme tuning	
Fine Tuning / Programme edit	
Calling the programme table	
PICTURE menu	15
PSM (Picture Status Memory)	
Picture adjustment	
XD (Excellent Digital)	
Picture format	
AUDIO menu	18
SSM (Sound Status Memory)	
AVL (Auto Volume Leveler) / Speaker adjustment	
Balance adjustment / Equalizer (option)	
Sound output selection / Stereo/Dual reception	
NICAM reception	
TIME menu	22
Auto sleep / Sleep timer	
SPECIAL menu	23
Main Picture Source Selection	
Child Lock / Cinema / Auto Demo	
Picture in picture (PIP) function	26
On and off / Input mode selection for sub picture	
Swapping between main and sub pictures	
Programme selection for sub picture / Sub picture size	
Sub picture freeze / Sub picture position change	
Teletext (option)	27
Switch on/off	
SIMPLE text / TOP text (option)	
FASTEXT / Special teletext functions	
Connection of external equipment	30
Aerial socket	
DVD input sockets / DTV input sockets	
Audio/Video input sockets (option)	
S-Video/Audio input sockets (option)	
Monitor output sockets / Connecting PC	
Troubleshooting check list	35

Installation

Power

This set operates on an AC mains supply, the voltage is as indicated on the label on the back cover. Never apply DC power to the set. In the event of thunderstorms or powercuts, please pull out the aerial and mains plugs.

Warning

To prevent fire or shock hazard, do not expose the set to rain or moisture.

Service

Never remove the back cover of the set as this can expose you to very high voltage and other hazards. If the set does not operate properly, unplug it and call your dealer.

Aerial

Connect the aerial cable to the socket marked 1175 Ω on the back cover. For the best reception an outdoor aerial should be used.

Location

Position your set so that no bright light or sunlight falls directly onto the screen. Care should be taken not to expose the set to any unnecessary vibration, moisture, dust or heat. Also ensure that the set is placed in a position to allow a free flow of air. Do not cover the ventilation openings on the back cover.

Avoid having a fixed image remain on the screen for a long period of time. Typically a frozen still picture from a VCR, 4:3 picture format or if a CH label is present; the fixed image may remain visible on the screen.

THE STANDARD OF PRODUCTION TECHNIQUES TODAY CANNOT GUARANTEE AN ABSOLUTELY FAULT FREE L.C.D. DISPLAY.

A FEW ISOLATED CONSTANT LIT OR DARK PIXELS (sub-pixels) MAY BE PRESENT. THIS MAY BE VISIBLE AS COLOURED DOTS ON SCREEN AND DOES NOT MEAN THE SCREEN IS UNACCEPTABLE OR FAULTY. Depending on area of screen, colour, lit or unlit, pixels are evaluated against a set criteria.

THE MAXIMUM NUMBER OF FAULTY SUBPIXELS PERMITTED IS STIPULATED IN THE STRINGENT INTERNATIONAL STANDARD ISO 13406-2 (Class III).

Manufactured under license from Dolby Laboratories. "Dolby" and the double-D symbol are trademarks of Dolby Laboratories.

Location and function of controls

All the functions can be controlled with the remote control handset. Some functions can also be adjusted with the buttons on the front panel of the set.

Remote control handset

Before you use the remote control handset, please install the batteries. See the next page.

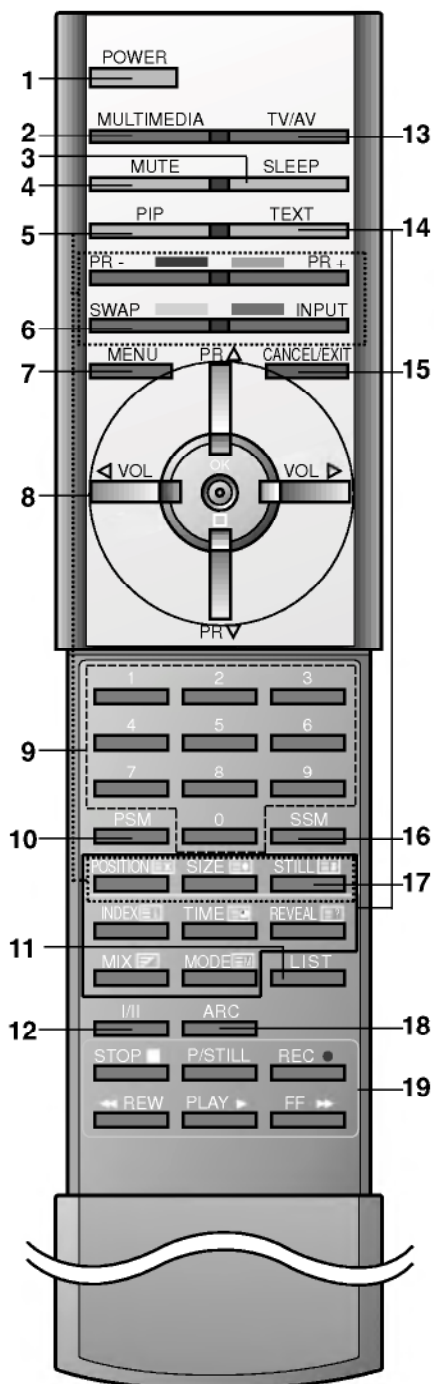

(With TELETEXT)

1. **POWER**
switches the set on from standby or off to standby.
2. **MULTIMEDIA**
selects **Component 1/2**, **RGB-DTV** or **RGB-PC** modes.
3. **SLEEP**
sets the sleep timer.
4. **MUTE**
switches the sound on or off.
5. **PIP BUTTONS**
PIP
switches the sub picture on or off.
PR +/-
selects a programme for the sub picture.
SWAP
alternates between main and sub picture.
INPUT
selects the input mode for the sub picture.
SIZE
adjusts the sub picture size.
STILL
freezes motion of the sub picture.
POSITION
relocates the sub picture in clockwise direction.
6. **SWAP**
returns to the previously viewed programme.
7. **MENU**
selects a menu.
8. **▲ / ▼ (Programme Up/Down)**
selects a programme or a menu item.
◀ / ▶ (Volume Down/Up)
adjusts the volume.
adjusts menu settings.
OK
accepts your selection or displays the current mode.
9. **NUMBER BUTTONS**
switches the set on from standby or directly select a number.
10. **PSM (Picture Status Memory)**
recalls your preferred picture setting.
11. **LIST**
displays the programme table.
12. **I/II**
selects the language during dual language broadcast.
selects the sound output.

Location and function of controls

13. TV/AV

selects the remote operating mode.
switches the set on from standby.

14. TELETEXT BUTTONS (option)

These buttons are used for teletext.
For further details, see the 'Teletext' section.

15. CANCEL/EXIT

Clears all on-screen displays and returns to TV viewing from any menu.

16. SSM (Sound Status Memory)

recalls your preferred sound setting.

17. STILL

freezes motion of the picture.

18. ARC (Aspect Ratio Control)

changes the picture format.

19. VCR BUTTONS

control a video cassette recorder.

Note : In teletext mode, the **PR +/-**, **SWAP** and **INPUT** buttons are used for teletext function.

Battery installation

The remote control handset is powered by two AAA type batteries. To load the batteries, turn the remote control handset over and open the battery compartment. Install two batteries as indicated by the polarity symbols (⊕ and ⊖) marked inside the compartment.



Note : To avoid damage from possible battery leakage, remove the batteries if you do not plan to use the remote control handset for an extended period of time.

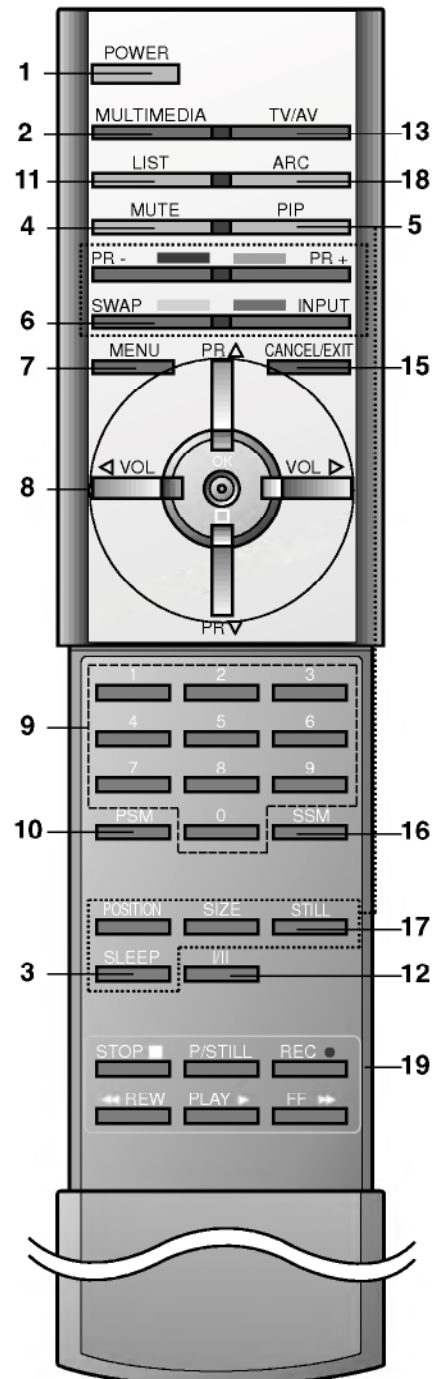

(Without TELETEXT)

Location and function of controls

Front panel

Lamp indicator, operation indicator, and temperature indicator, located below the front panel controls reveal the operating status of the set.

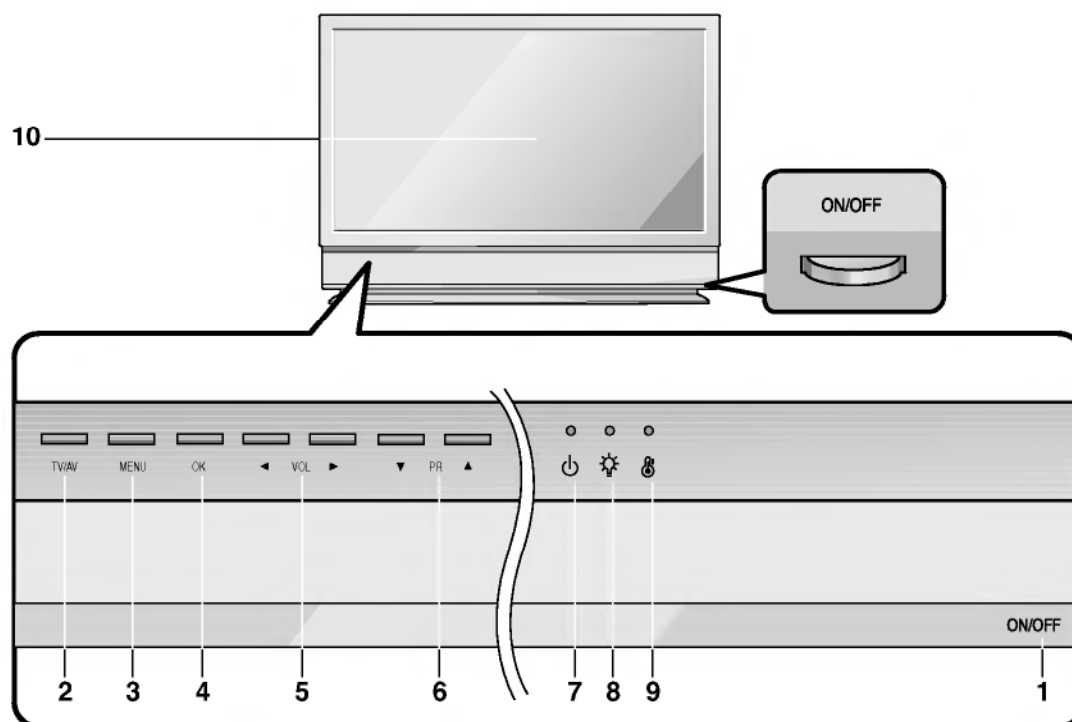

1. **MAIN POWER (ON/OFF)**
switches the set on or off.
2. **TV/AV**
selects the remote operating mode.
switches the set on from standby.
3. **MENU**
selects a menu.
4. **OK**
accepts your selection or displays the current mode.
5. **◀ / ▶ (Volume Down/Up)**
adjusts the volume.
adjusts menu settings.
6. **▲ / ▼ (Programme Up/Down)**
selects a programme or a menu item.
switches the set on from standby.
7. **OPERATION INDICATOR** (Refer to p.7)
8. **LAMP INDICATOR** (Refer to p.7)
9. **TEMPERATURE INDICATOR** (Refer to p.7)
10. **REMOTE CONTROL SENSOR**

Note :

- a. Shown is a simplified representation of front or side panel. Here shown may be somewhat different from your set.
- b. There might be a faint white trace on the center of the screen according to the position. This is normal and is a characteristic of the screen.

Location and function of controls

Rear panel

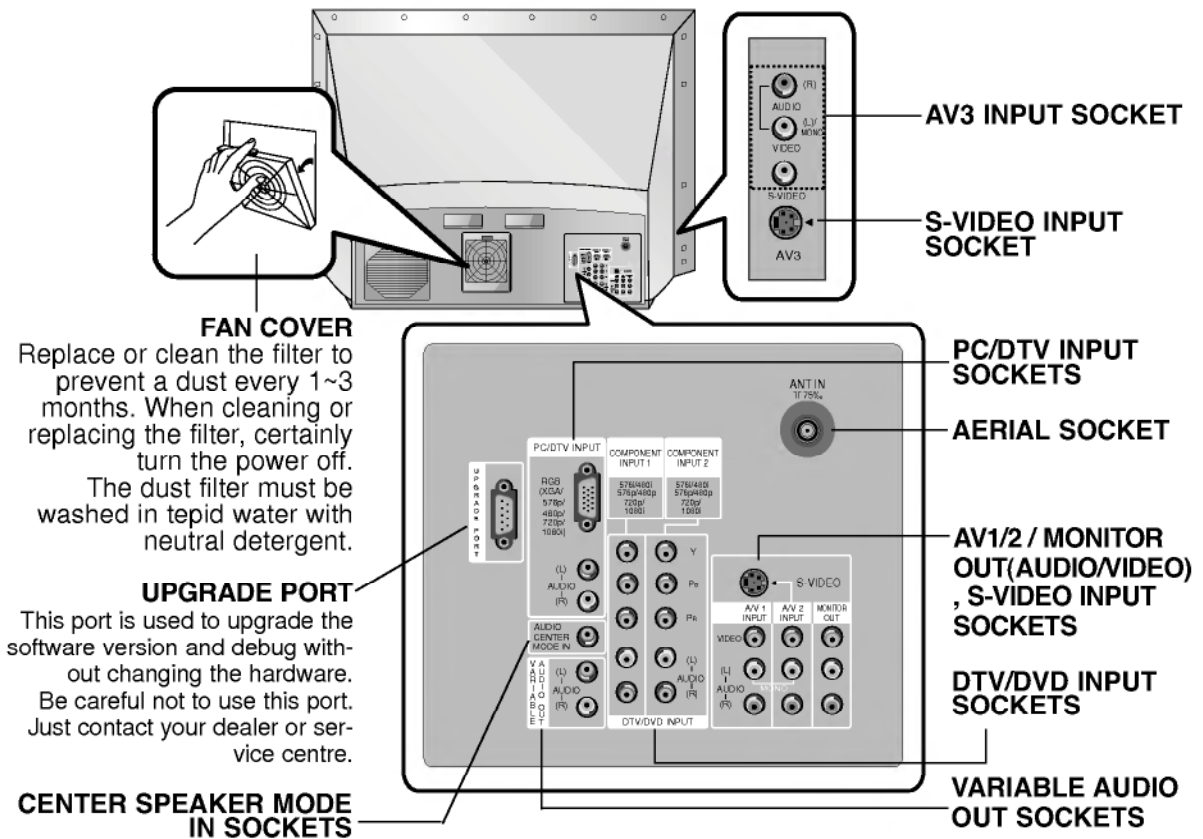

•Status Indicators

Operation Indicator	Off	Power cord is not connected.
	Red	Power Cord is connected, unit is on standby.
	Green	On
	Orange (flashing)	Preparing operation in standby.
Lamp Indicator	Orange	Projection lamp is reaching the end of its life and needs to be replaced with a new lamp.
	Red (flashing)	There is a problem with the lamp or around it. Contact an authorized service center.
	Green (flashing)	The lamp cover is not closed.
Temperature Indicator	Orange	The set is overheating.
	Red	The set has shut down due to overheating.
	Red (flashing)	The set has shut down, check the cooling fan.

Basic Operation

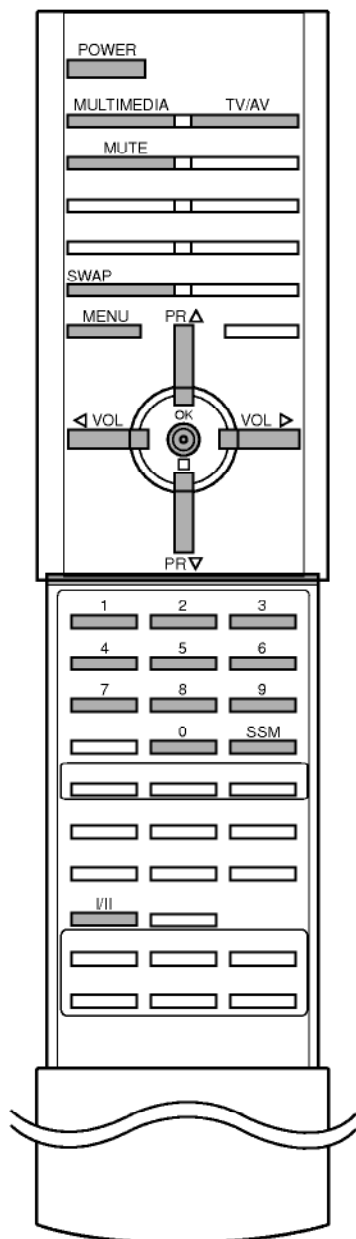

On and off

1. Before turning the set on, be sure that the main power switch on the set is pushed on.
When the main switch is pushed on, the LED will be lit up red. This mode is Stand-by.
2. If the set is in stand-by mode, press the **POWER**, **▲ / ▼**, **TV/AV**, **MULTIMEDIA** or **NUMBER** button on the remote control handset to turn it on fully. The LED will blink orange for a while and then lit up green when the power is successfully on.
3. To turn the set off, press the power button on the remote control handset. The set reverts to the stand-by mode.

Note :

- a. The lamp cooling fan will continue to spin for approximately 120 seconds after the power is turned off by the remote control handset.
- b. Normally, don't push off the main power switch. Instead, use the remote control to turn the power off.
- c. When the set is turned on again immediately after turning off, it takes around 30 to 50 seconds for sufficient cooling.
- d. When the power is switched off using the main power switch on the set, the internal cooling system also stops operating. Therefore, power-on by main power switch takes around 30 to 50 seconds for sufficient cooling.
- e. **Forced Power-Off :** When the set decides itself that the circumstance is not proper for operation, the set will go to the stand-by mode automatically. Please retry to turn on the set after a short period of time.
- f. When the set is switched on, there might be a strange sound from the set.

Programme selection

You can select a programme number with the **▲ / ▼** or **NUMBER** buttons.

Volume adjustment

Press the **◀ / ▶** button to adjust the volume.

Quick view

Press the **SWAP** button to view the last programme you were watching.

Mute function

Press the **MUTE** button. The sound is switched off and the display  Mute appears.

You can cancel it by pressing the **MUTE**, **◀ / ▶**, **SSM**, **VII** button.

On screen language selection (option)

The menu can be displayed on the screen in desired language. First select your language.

1. Press the **MENU** button and then **▲ / ▼** button to select the Special menu.
2. Press the **▶** button and then the **▲ / ▼** button to select **Language**.
3. Press the **▶** button and then the **▲ / ▼** button to select your desired language.
4. Press the **OK** or **◀** button.
All the on screen displays will appear in the selected language.
5. Repeatedly press the **MENU** button to return to normal TV viewing.

On Screen Menus

The dialogue between you and your set takes place on screen with an operator menu. The buttons required for the operating steps are also displayed.

Menu selection

1. Press the **MENU** button and then **▲** / **▼** button to display each menu.
2. Press the **▶** button and then the **▲** / **▼** button to select a menu item.
3. Repeatedly press the **MENU** button to return to normal TV viewing.

Note :

- a. In the teletext mode, menus are not displayed.
- b. On some models, the **Language** will not be displayed.

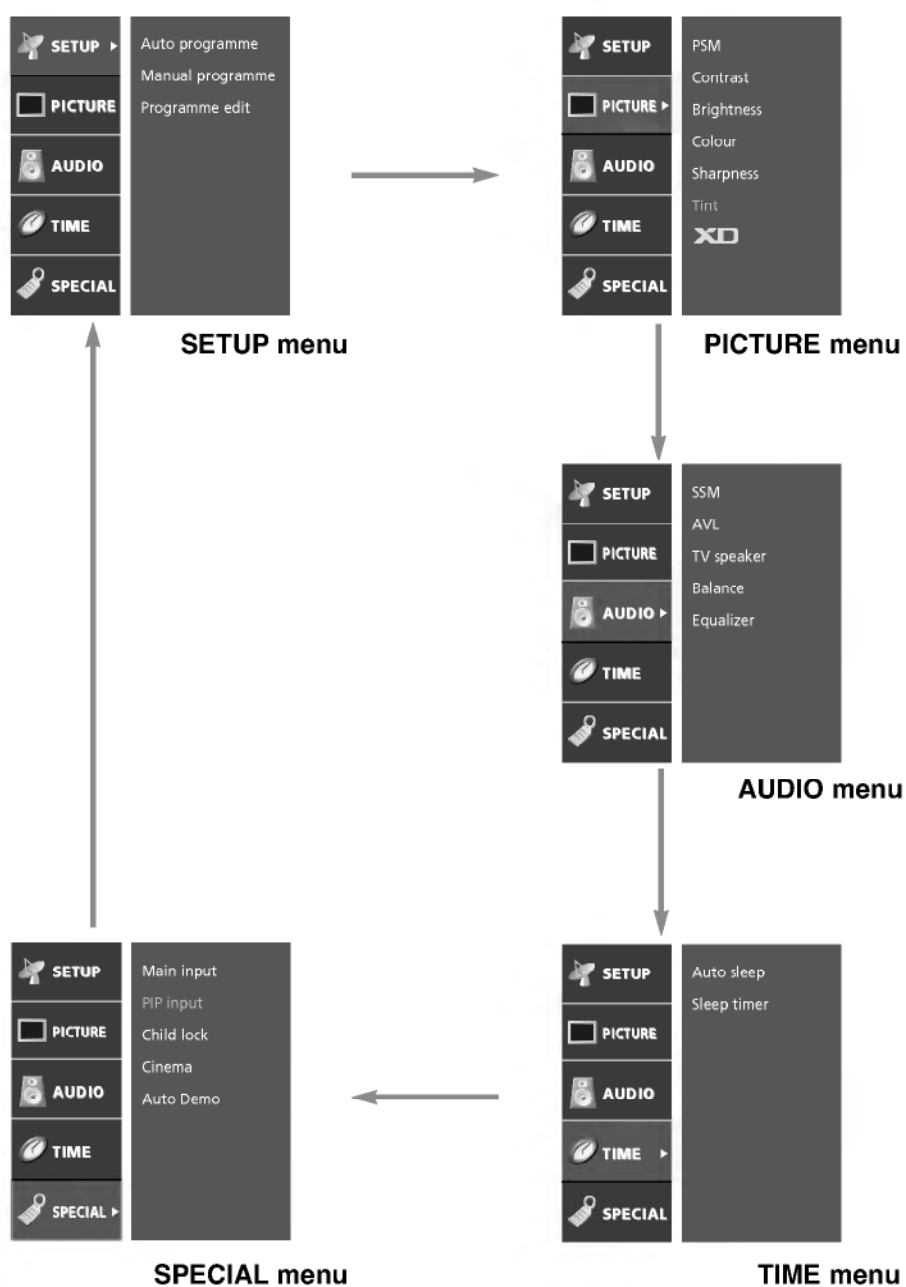

SETUP Menu



Up to 100 TV stations can be stored in this set by programme numbers (0 to 99). Once you have preset the stations, you will be able to use the ▲ / ▼ or NUMBER buttons to scan the stations you programmed. Stations can be tuned using automatic or manual modes.

Note : In some models up to 200 TV stations can be stored.

Auto programme tuning

All stations that can be received are stored by this method. It is recommended that you use Auto programme during installation of this set.

1. Press the **MENU** button and then ▲ / ▼ button to select the SETUP menu.
2. Press the ► button and then ▲ / ▼ button to select **Auto programme**.

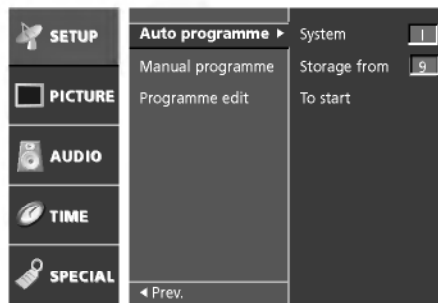
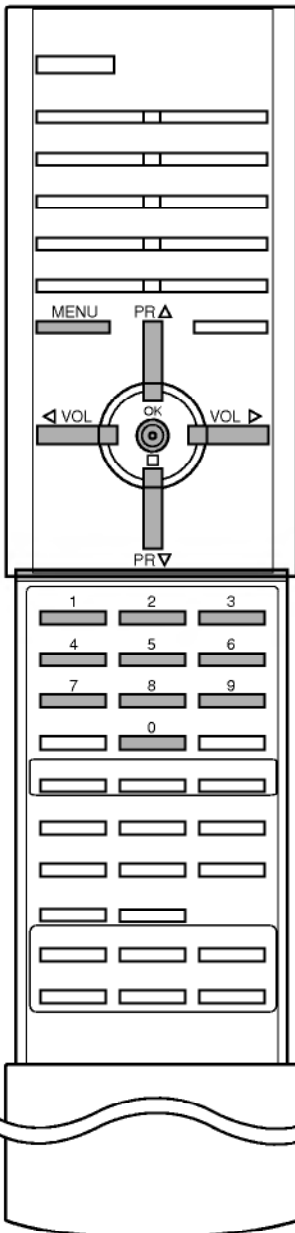

3. Press the ► button to select **System**. Select a TV system with the ▲ / ▼ button;
 - BG** : (Asia/New Zealand/M.East/Africa/Australia)
 - I** : (Hong Kong/South Africa)
 - DK** : (East Europe/China/Africa/CIS)
 - M** : (USA/Korea/Philippines) (option)
4. Press the ► button to select **Storage from**. Select the beginning programme number with the ▲ / ▼ button or NUMBER buttons on the **Storage from** menu.
5. Press the ► button to select **To start**.
6. Press the ► button to begin auto programming.

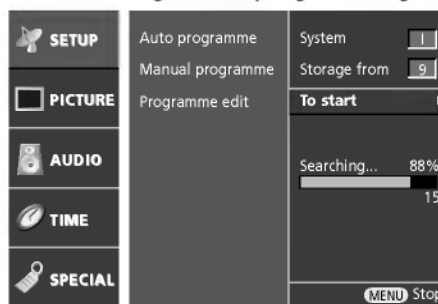

All receivable stations are stored.

Option: In Australia, if no station name can be assigned to a station, the channel number is assigned and stored as ----- followed by a number see 'Assigning a station name' section to assign the station name.

To stop auto programming, press the **MENU** button. When auto programming is completed, the **Programme edit** menu appears on the screen. See the 'Programme Edit' section to edit the stored programme.

7. Repeatedly Press the **MENU** button to return to normal TV viewing.

SETUP Menu

Manual programme tuning

Manual programme lets you manually tune and arrange the stations in whatever order you desire. Also you can assign a station name with five characters to each programme number.

1. Press the **MENU** button and then **▲ / ▼** button to select the **SETUP** menu.
2. Press the **▶** button and then **▲ / ▼** button to select **Manual programme**.
3. Press the **▶** button to display the **Manual programme** menu.

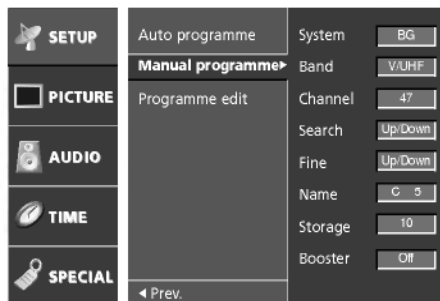

4. Press the **▶** button to select **System**. Select a TV system with the **▲ / ▼** button;
 - BG** : (Asia/New Zealand/M.East/Africa/Australia)
 - I** : (Hong Kong/South Africa)
 - DK** : (East Europe/China/Africa/CIS)
 - M** : (USA/Korea/Philippines) (option)
5. Press the **▶** button to select **Band**. Press the **▲ / ▼** button to select **V/UHF** or **Cable** as required.
6. Press the **▶** button to select **Channel**. Select the desired channel number with the **▲ / ▼** button or **NUMBER** buttons. If possible, select the channel number(1 to 69) directly with the number buttons.
7. Press the **▶** button to select **Search**. Press the **▲ / ▼** button to commence searching. If a station is found the search will stop.
8. If this station is the one required, press the **◀ / ▶** button to select **Storage**. Select the desired programme number with the **▲ / ▼** button or **NUMBER** buttons.
9. Press the **OK** button to store it.
10. To store another station, repeat steps 4 to 9.
11. Repeatedly press the **MENU** button to return to normal TV viewing.

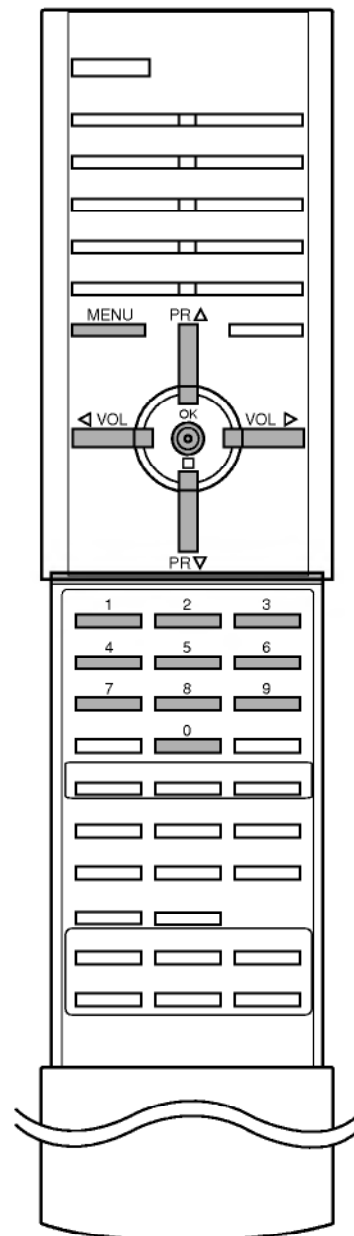

SETUP Menu



Assigning a station name

1. Repeat the 'Manual programme tuning' steps 1 to 3.
2. Press the ► button to select **Name**.
3. Press the ▲ button. You can use a blank, +, -, the numeric **0** to **9** and the alphabet **A** to **Z**.
With the ▼ button you can select in the opposite direction.
4. Select the next position by pressing the ► button and then take your choice of the second character, and so on.
5. Press the **OK** button.
6. Repeatedly press the **MENU** button to return to normal TV viewing.

Booster (option)

In some models, **Booster** is an optional function. Only a set with **Booster** can perform this function.

If the reception is poor at the fringe area of TV signal, select **Booster** to **On**.

1. Repeat the 'Manual programme tuning' steps 1 to 3.
2. Press the ► button to select **Booster**.
3. Press the ▲ / ▼ button to select **On** or **Off**.
4. Repeatedly press the **MENU** button to return to normal TV viewing.

Fine tuning

Normally fine tuning is only necessary if reception is poor.

1. Repeat the 'Manual programme tuning' steps 1 to 3.
2. Press the ► button to select **Fine**.
3. Press the ▲ / ▼ button to fine tune for the best picture and sound.

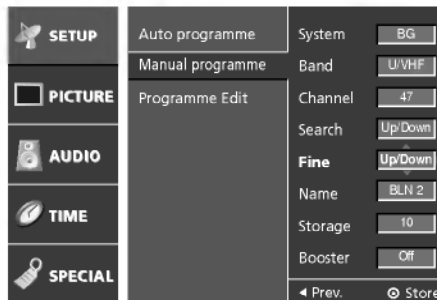
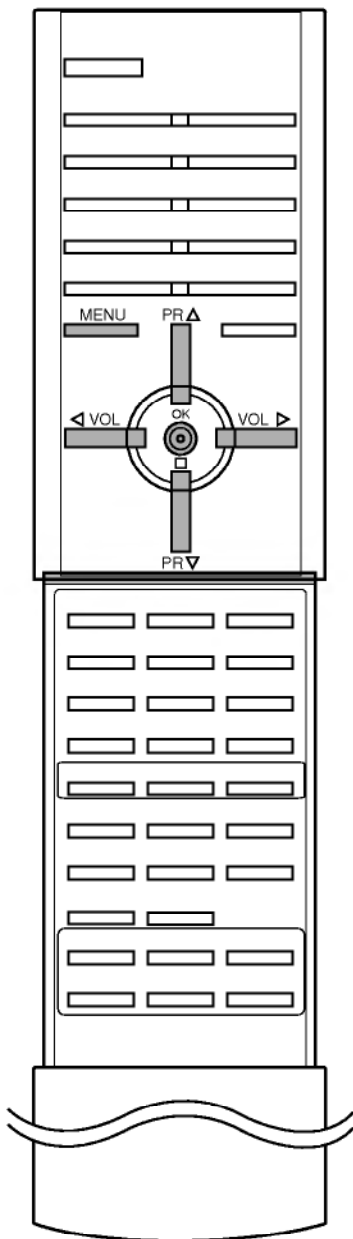

4. Press the **OK** button.
5. Repeatedly press the **MENU** button to return to normal TV viewing.
The finely tuned programme will be indicated by yellow number during programme selection.

SETUP Menu

Programme edit

This function enables you to delete or skip the stored programmes. Also you can move some stations to other programme numbers or copy a blank station data into the selected programme number.

1. Press the **MENU** button and then ▲ / ▼ button to select the **SETUP** menu.
2. Press the ► button and then ▲ / ▼ button to select **Programme edit**.
3. Press the ► button to display the **Programme edit** menu.

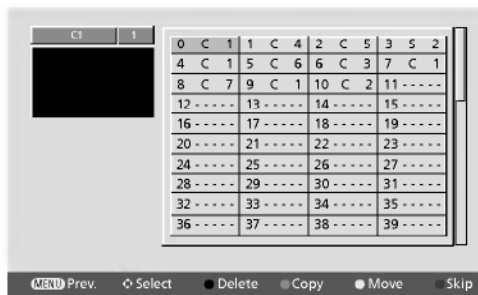

Deleting a programme

1. Select a programme to be deleted with the ▲ / ▼ or ◀ / ▶ button.
2. Press the **RED** button twice.
The selected programme is deleted, all the following programmes are shifted up one position.

Copying a programme

1. Select a programme to be copied with the ▲ / ▼ or ◀ / ▶ button.
2. Press the **GREEN** button.
3. Move the programme to the desired programme number with the ▲ / ▼ or ◀ / ▶ button.
4. Press the **GREEN** button again to move the programme.
All the following programmes are shifted down one position.

Moving a programme

1. Select a programme to be moved with the ▲ / ▼ or ◀ / ▶ button.
2. Press the **YELLOW** button.
3. Move the programme to the desired programme number with the ▲ / ▼ or ◀ / ▶ button.
4. Press the **YELLOW** button again to release this function.

Skipping a programme number

1. Select a programme number to be skipped with the ▲ / ▼ or ◀ / ▶ button.
2. Press the **BLUE** button. The skipped programme turns to blue.
3. Press the **BLUE** button again to release the skipped programme.

When a programme number is skipped it means that you will be unable to select it using the ▲ / ▼ button during normal TV viewing. If you want to select the skipped programme, directly enter the programme number with the **NUMBER** buttons or select it in the programme edit or table menu.

Repeatedly press the **MENU** button to return to normal TV viewing.

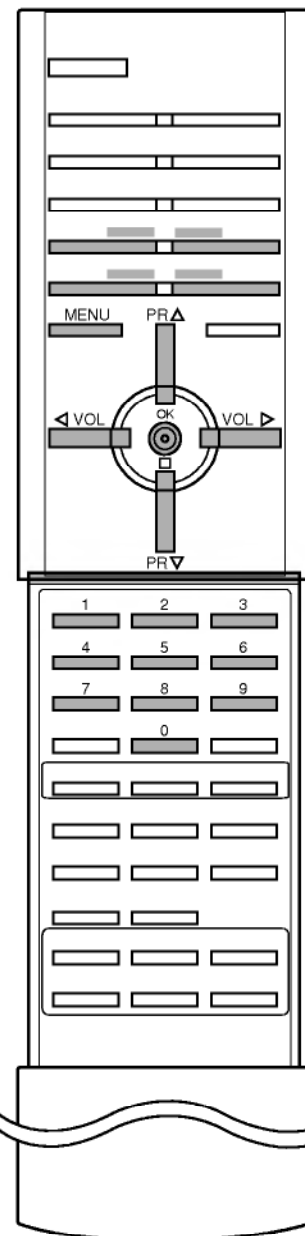

SETUP Menu

Calling the programme table

You can check the programmes stored in the memory by displaying the programme table.

Displaying programme table

Press the **LIST** button to display the Programme table menu. The programme table appears on the screen.

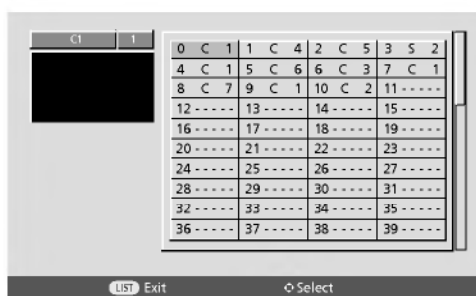
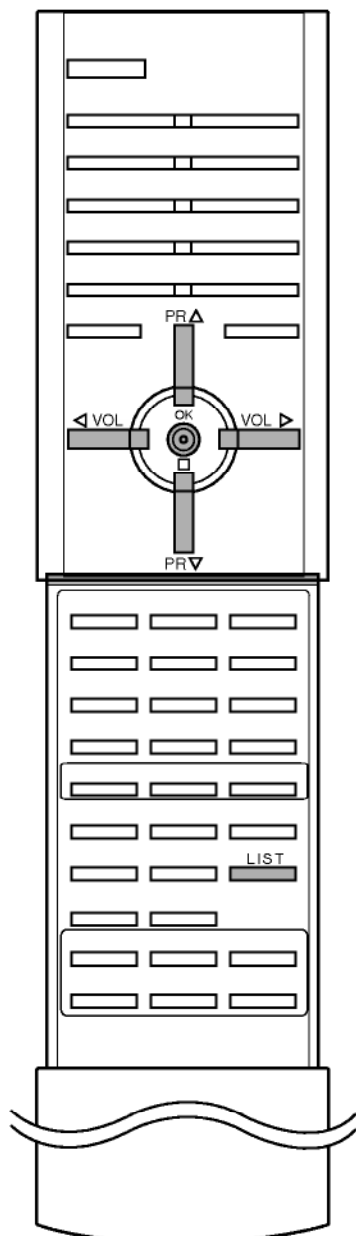

Note :

- You may find some blue highlighted programmes shown. They have been set up in the programme edit mode.
- Some programmes with the channel number shown in the programme table indicate there is no station name assigned.

Selecting a programme in the programme table

Select a programme with the ▲ / ▼ or ◀ / ▶ button. The set switches to the chosen programme number.

Paging through a programme table

There are 3 programme table pages in which contain 100 programmes.

Pressing the ▲ / ▼ or ◀ / ▶ button repeatedly turns the pages.

Press the **LIST** button to return to normal TV viewing.

PICTURE Menu

PSM (Picture Status Memory)

1. Press the **MENU** button and then **▲** / **▼** button to select the **PICTURE** menu.
2. Press the **▶** button and then **▲** / **▼** button to select **PSM**.
3. Press the **▶** button and then **▲** / **▼** button to select a picture setting on the **PSM** pull-down menu.

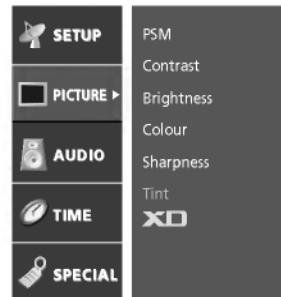
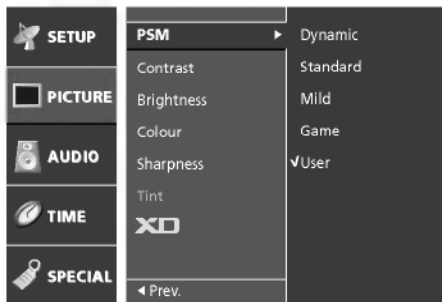

4. Press the **OK** or **◀** button.
5. Repeatedly press the **MENU** button to return to normal TV viewing.

Picture adjustment

You can adjust picture contrast, brightness, colour intensity, sharpness and tint (NTSC input only) to the levels you prefer.

1. Press the **MENU** button and then **▲** / **▼** button to select the **PICTURE** menu.
2. Press the **▶** button and then **▲** / **▼** button to select the desired picture item.
3. Press the **▶** button and then **◀** / **▶** button to make appropriate adjustments, then it will be stored for the picture User.



4. Press the **OK** button.
5. Repeatedly press the **MENU** button to return to normal TV viewing.

To recall your preferred setting, press the **PSM** button until the desired picture (**Dynamic**, **Standard**, **Mild**, **Game** or **User**) appears. The picture **Dynamic**, **Standard**, **Mild** and **Game** are programmed for good picture reproduction at the factory and cannot be changed.

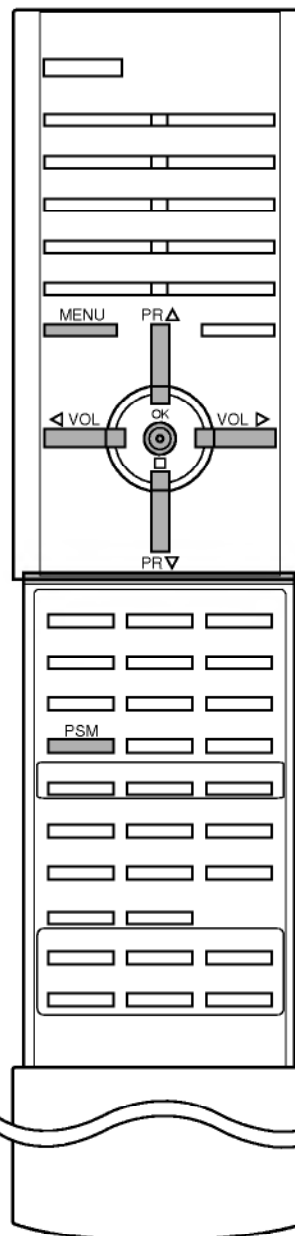

PICTURE Menu

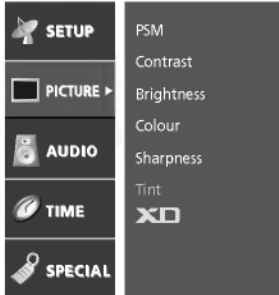

XD (Excellent Digital)

You can enjoy the vivid and hi-definition picture with Digital Reality processor technology.

When selecting picture options (**Dynamic, Standard, Mild** and **Game**) in PICTURE menu, **XD** is automatically changed to **On**.

1. Press the **MENU** button and then **▲ / ▼** button to select the **PICTURE** menu.
2. Press the **▶** button and then **▲ / ▼** button to select **XD**.

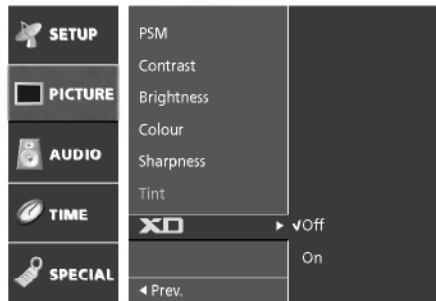
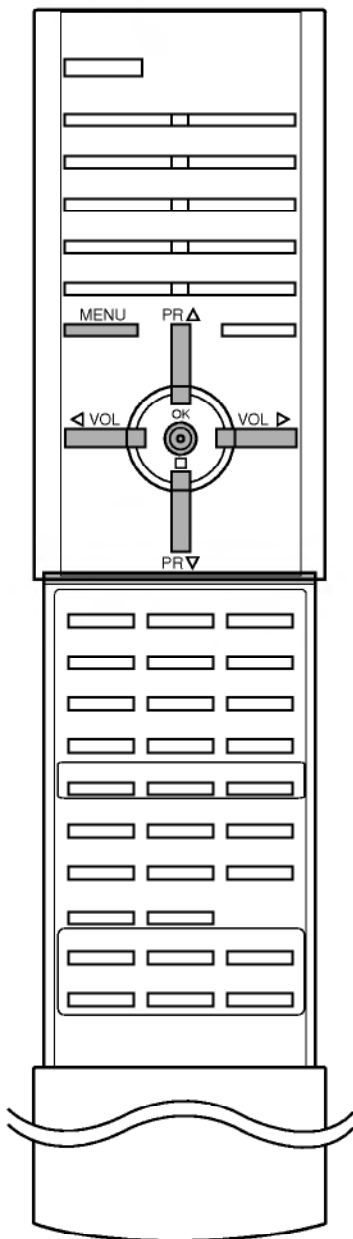

3. Press the **▶** button and then **▲ / ▼** button to select a picture setting on the **XD** pull-down menu.
4. Press the **OK** or **◀** button.
5. Repeatedly press the **MENU** button to return to normal TV viewing.

PICTURE Menu

Picture format

You can watch TV in various picture formats; Auto, 4:3, 16:9 (Wide), 14:9 and Zoom.

You can repeatedly press the **ARC** button to select your desired picture format.

Auto

When your TV receives the wide screen signal (WSS), it will be automatically changed to the picture format to be sent. (Not available in all countries)

4:3

Following selection will lead you to view a picture with an original 4:3 aspect ratio, with black bars appearing at both the left and right sides.

16:9

Following selection will lead you to adjust the picture horizontally, in a linear proportion, to fill the entire screen (useful for viewing 4:3 formatted DVDs).

14:9

You can enjoy the picture format of 14:9 or general TV programme through the 14:9 mode.

The screen 14:9 is viewed just like that the screen 4:3 is magnified to the upper / lower and left / right. You can move the screen up or down with ▲ / ▼ button.

Zoom

Following selection will lead you to view the picture without any alternation, while filling the entire screen. However, the top and bottom portions of the picture will be cropped. You can move the screen up or down with ▲ / ▼ button.

Note :

a : **4:3** and **16:9** are available in Component (720p/1080i), RGB-DTV (720p/1080i) and RGB-PC mode only.

b : **Auto** is not available in Component (720p/1080i) mode only.

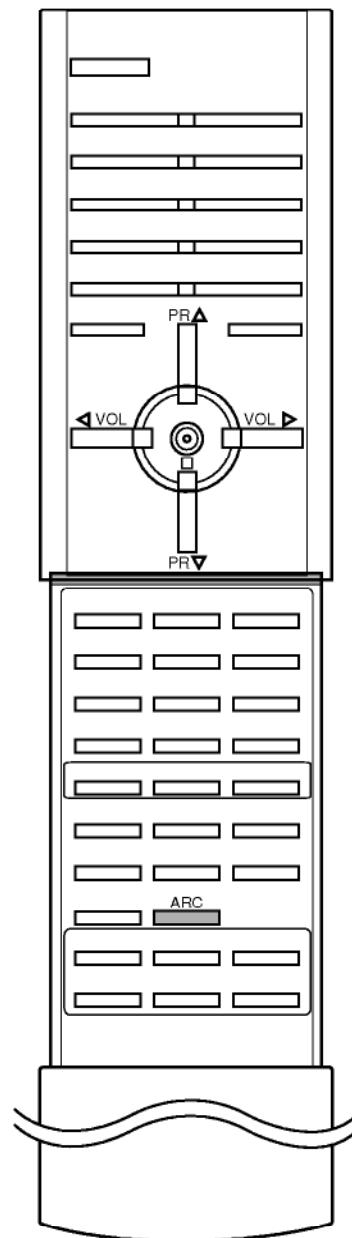

AUDIO Menu

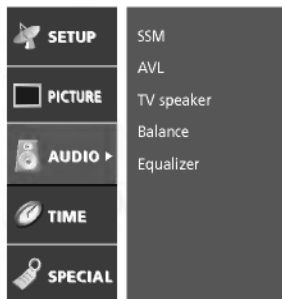

SSM (Sound Status Memory)

You can select your preferred sound setting; Dolby Virtual, Flat, Music, Movie, or Speech and you can also adjust the sound frequency of equalizer, balance. If you switch AVL to on, the set automatically keeps on an equal volume level even if you change programmes.

1. Press the **MENU** button and then **▲ / ▼** button to select the **AUDIO** menu.
2. Press the **▶** button and then **▲ / ▼** button to select **SSM**.
3. Press the **▶** button and then **▲ / ▼** button to select a sound setting on the **SSM** pull-down menu.

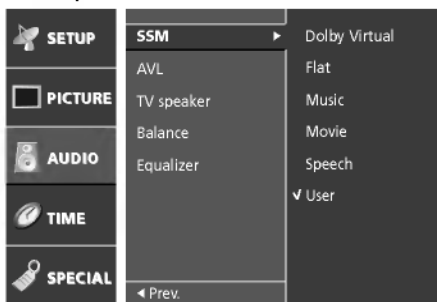

4. Press the **OK** or **◀** button.
5. Repeatedly press the **MENU** button to return to normal TV viewing.

Dolby Virtual

Dolby Virtual lets you experience panoramic effects of sound.

To recall your preferred setting, press the **SSM** button until the desired sound (**Dolby Virtual, Flat, Music, Movie, Speech** or **User**) appears. The sound **Dolby Virtual, Flat, Music, Movie** and **Speech** are programmed for good sound reproduction at the factory and cannot be changed.

Note : If you press the **SSM** button after making appropriate adjustment on the **Equalizer** sub menu, the display **User** automatically appears even though you have already set a factory preset setting; **Dolby Virtual, Flat, Music, Movie** or **Speech**.

AVL (Auto Volume Leveler)

If you select **AVL On**, the set automatically keeps on an equal volume level even if you change programmes.

1. Press the **MENU** button and then **▲ / ▼** button to select the **AUDIO** menu.
2. Press the **▶** button and then **▲ / ▼** button to select **AVL**.
3. Press the **▶** button and then **▲ / ▼** button to select **On** or **Off** on the **AVL** pull-down menu.

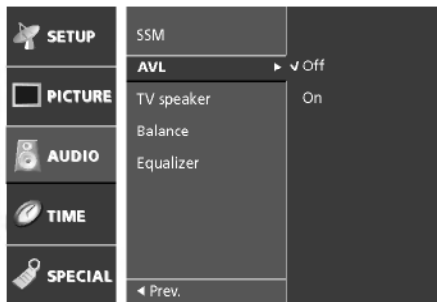

4. Press the **OK** or **◀** button.
5. Repeatedly press the **MENU** button to return to normal TV viewing.

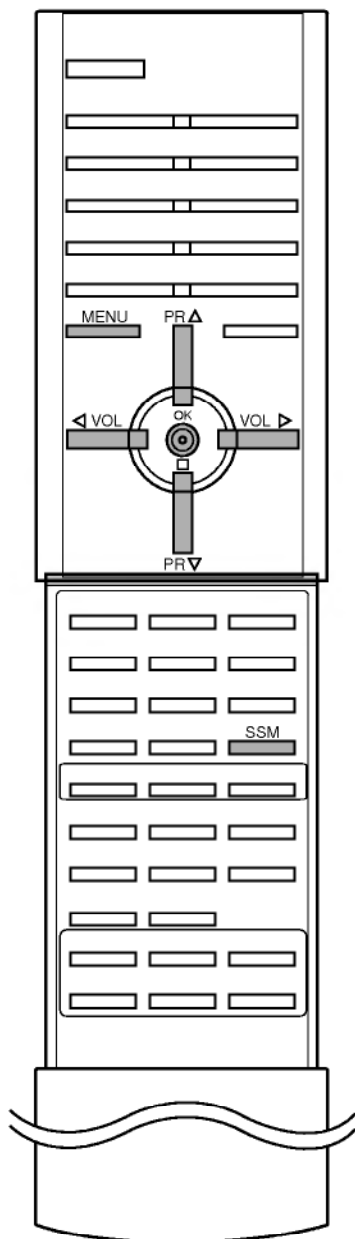

AUDIO Menu

Speaker adjustment

You can adjust internal speaker status.

1. Press the **MENU** button and then **▲ / ▼** button to select the **AUDIO** menu.
2. Press the **▶** button and then **▲ / ▼** button to select **TV speaker**.
3. Press the **▶** button and then **▲ / ▼** button to select **On**, **Center** or **Off** on the **TV speaker** pull-down menu.

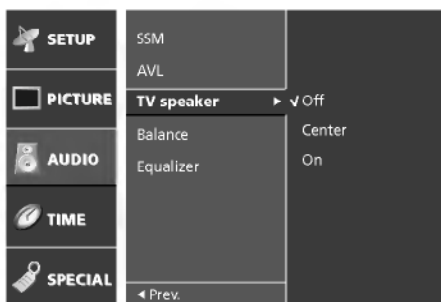

4. Press the **OK** button.
5. Repeatedly press the **MENU** button to return to normal TV viewing.

Note :

- a. When you select **Center** on the **TV speaker** pull-down menu, it is output external audio system's audio connected to **AUDIO CENTER MODE IN** socket on the back of the set.
- b. In **Component/2, RGB-PC** and **RGB-DTV** mode, TV speaker/variable audio can be output even though there is no video signal.

Balance adjustment

You can adjust balance.

1. Press the **MENU** button and then **▲ / ▼** button to select the **AUDIO** menu.
2. Press the **▶** button and then **▲ / ▼** button to select **Balance**.
3. Press the **▶** button.

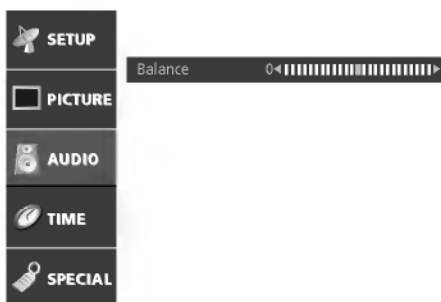

4. Make desired adjustment with the **◀ / ▶** button on the Balance pull-down menu.
5. Press the **OK** button.
6. Repeatedly press the **MENU** button to return to normal TV viewing.

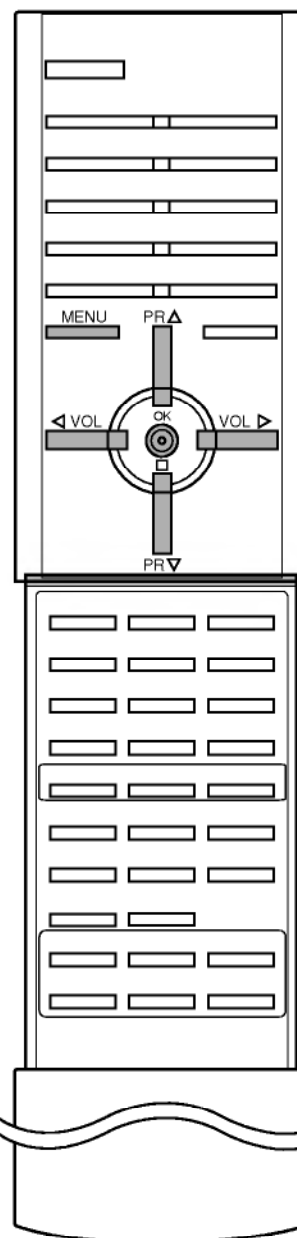

AUDIO Menu

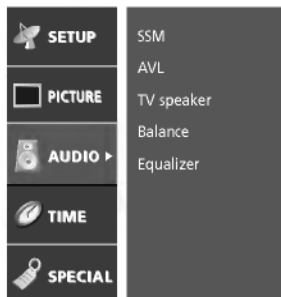

Equalizer (option)

1. Press the **MENU** button and then **▲ / ▼** button to select the AUDIO menu.
2. Press the **▶** button and then **▲ / ▼** button to select **Equalizer**.
3. Press the **▶** button in **Equalizer** to display the **Equalizer** sub menu.

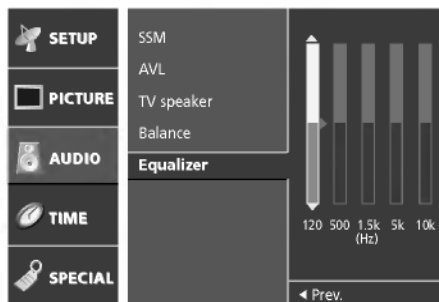

4. Select a sound band by pressing the **◀ / ▶** button.
5. Make appropriate sound level with the **▲ / ▼** button.
6. Press the **OK** button.
7. Repeatedly press the **MENU** button to return to normal TV viewing.

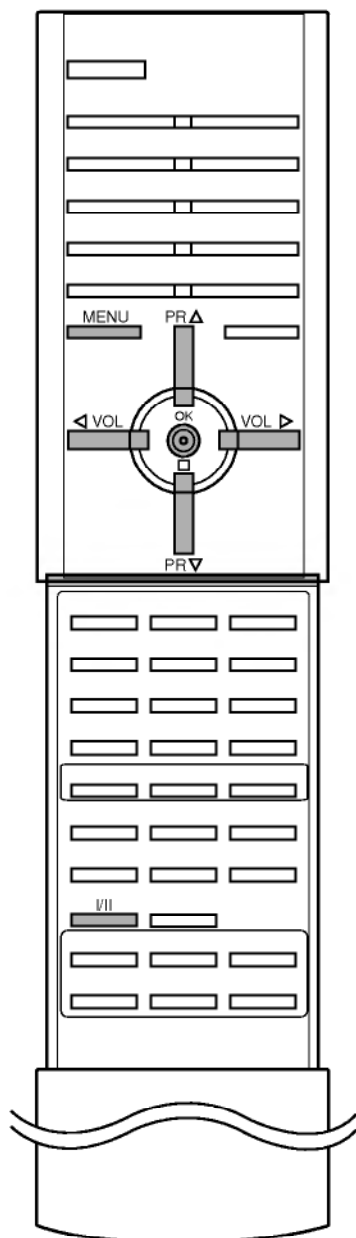

Sound output selection

In AV mode, you can select output sound for the left and right loudspeakers.

Repeatedly press the **VII** button to select the sound output.

L+R : Audio signal from audio L input is sent to the left loud speaker and audio signal from audio R input is sent to the right loud speaker.

L+L : Audio signal from audio L input is sent to left and right loudspeakers.

R+R : Audio signal from audio R input is sent to left and right loudspeakers.

AUDIO Menu

Stereo/Dual reception

When a programme is selected, the sound information for the station appears after the programme number and station name disappear.

Broadcast	On Screen Display
Mono	MONO
Stereo	STEREO
Dual	DUAL I

Mono sound selection

In stereo reception if the stereo signal is weak, you can switch to mono by pressing the **I/II** button twice. In mono reception the depth of sound is improved. To switch back to stereo, press the **I/II** button twice again.

Language selection for dual language broadcast

If a programme received in two languages (dual language), you can switch to **DUAL I**, **DUAL II** or **DUAL I+II** by pressing the **I/II** button repeatedly.

DUAL I sends the primary broadcast language to the loudspeakers.

DUAL II sends the secondary broadcast language to the loudspeakers.

DUAL I+II sends a separate language to each loudspeaker.

NICAM reception

If your set is equipped with the receiver for NICAM reception, the high quality NICAM (Near Instantaneous Companding Audio Multiplex) digital sound can be received.

Sound output can be selected according to the type of received broadcast as follows by pressing the **I/II** button repeatedly.

1. When NICAM mono is received, you can select **NICAM MONO** or FM MONO.
2. When NICAM stereo is received, you can select **NICAM STEREO** or FM MONO. If the stereo signal is weak, switch to FM mono.
3. When NICAM dual is received, you can select **NICAM DUAL I**, **NICAM DUAL II** or **NICAM DUAL I+II** or **MONO**.

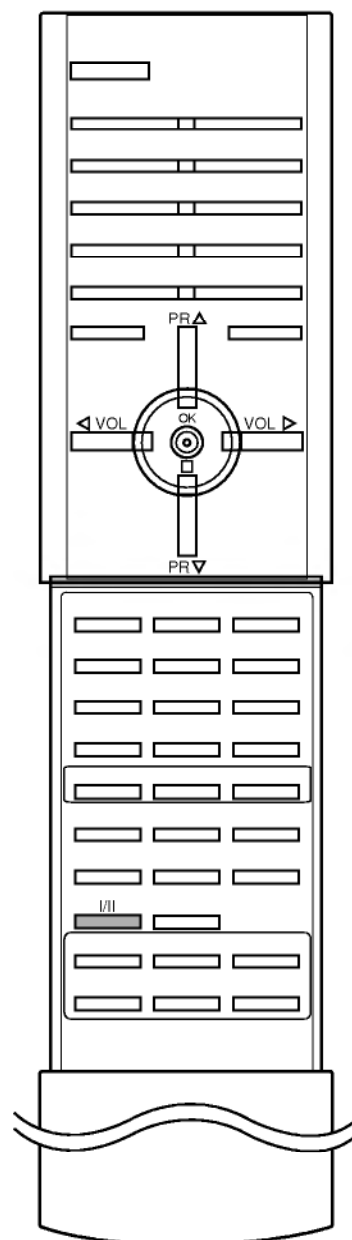

TIME Menu

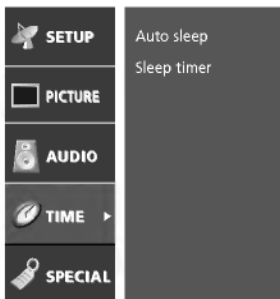

Auto sleep

If there is no input signal, the set will turn off automatically after 10 minutes.

1. Press the **MENU** button and then **▲ / ▼** button to select the Time menu.
2. Press the **▶** button and then **▲ / ▼** button to select **Auto sleep**.
3. Press the **▶** button and then **▲ / ▼** button to select **On** or **Off**.

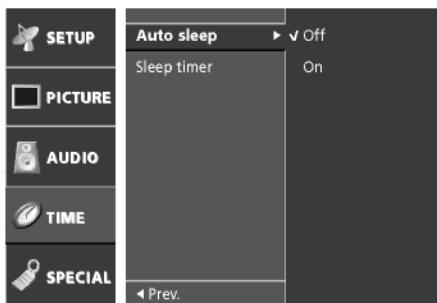

4. Press the **OK** or **◀** button.
5. Repeatedly press the **MENU** button to return to normal TV viewing.

Sleep timer

You don't have to remember to switch the set off before you go to bed. The sleep timer automatically switches the set to standby after the preset time elapses.

1. Press the **MENU** button and then **▲ / ▼** button to select the Time menu.
2. Press the **▶** button and then **▲ / ▼** button to select **Sleep timer**.
3. Press the **▶** button and then **▲ / ▼** button to select a timer setting on the **Sleep timer** pull-down menu.
4. Press the **OK** or **◀** button.

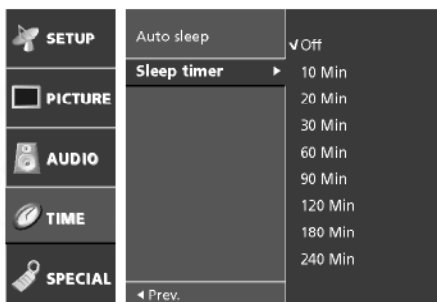

5. Repeatedly press the **MENU** button to return to normal TV viewing.

Press the **SLEEP** button to select the number of minutes. The display will appear on the screen, followed by **10, 20, 30, 60, 90, 120, 180** and **240**. The timer begins to count down from the number of minutes selected.

Note :

- a. To view the remaining sleep time, press the **SLEEP** button once.
- b. To cancel the sleep time, repeatedly press the **SLEEP** button until the display **Off** appears.
- c. When you switch the set off, the set releases the preset sleep time.

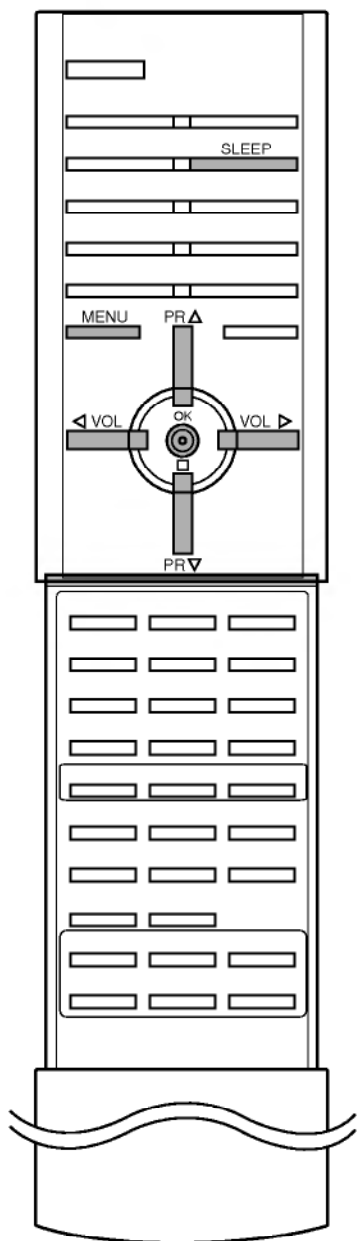

SPECIAL Menu

Main Picture Source Selection

Inputs can be set for TV or AV mode. AV mode is used when a video cassette recorder (VCR), or other equipment is connected to the set.

Note : When a VCR is connected via the aerial socket the set is used in TV mode. See the 'Connection of external equipment' section.

1. Press the **MENU** button and then **▲ / ▼** button to select the **SPECIAL** menu.
2. Press the **▶** button and then **▲ / ▼** button to select **Main input**.
3. Press the **▶** button and then **▲ / ▼** button to select **TV**, **AV1**, **AV2**, **AV3**, **Component1**, **Component2**, **RGB-DTV** or **RGB-PC**.

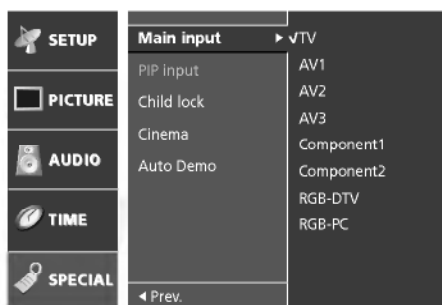
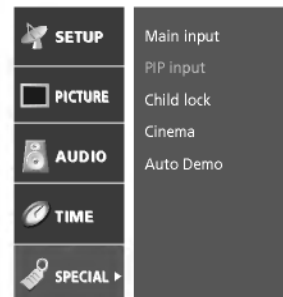

AV1 : VCR connected to the **AV1 INPUT** sockets of the set.
 AV2 : VCR connected to the **AV2 INPUT** sockets of the set.
 AV3 : VCR connected to the **AV3 INPUT** sockets of the set.
 Component1/2 : DVD or SET-TOP Box connected to the **DTV/DVD INPUT** sockets on the back of set.
 RGB-DTV : SET TOP Box connected to the **PC/DTV INPUT** sockets on the back of set.

- RGB-PC : PC connected to the **PC/DTV INPUT** sockets on the back of set.
4. Press the **OK** or **◀** button.
 5. Repeatedly press the **MENU** button to return to normal TV viewing.

Alternatively you can select the TV or AV mode by pressing the **TV/AV** button.

In AV mode, to return to TV mode, press the **▲ / ▼** or **NUMBER** buttons.

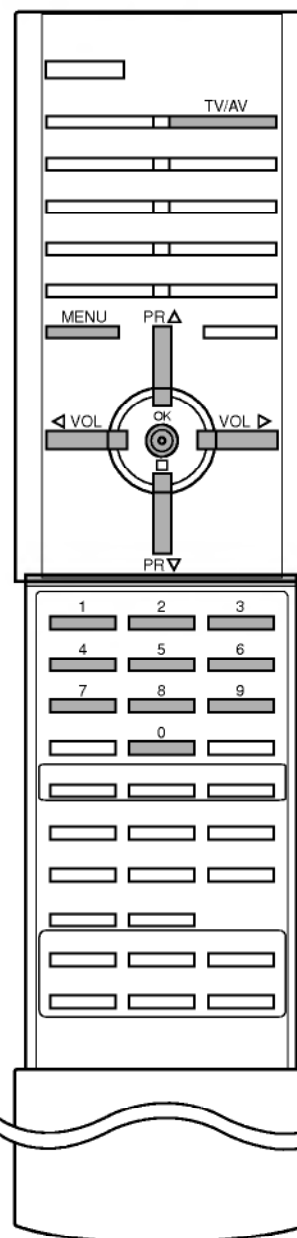

SPECIAL Menu

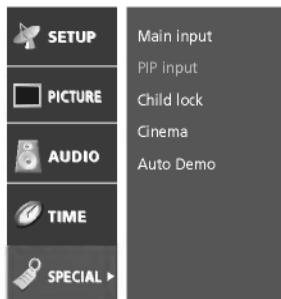

Child Lock

The TV can be set so that the remote control handset is needed to control it. This feature can be used to prevent unauthorized viewing.

1. Press the **MENU** button and then **▲ / ▼** button to select the **SPECIAL** menu.
2. Press the **▶** button and then **▲ / ▼** button to select **Child lock**.
3. Press the **▶** button and then **▲ / ▼** button to select **On** or **Off**.

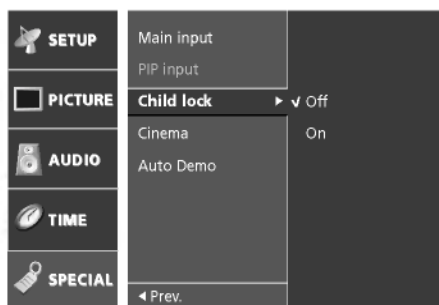

4. Repeatedly press the **MENU** button to return to normal TV viewing.

With the lock on, the display **Child lock On** appears on the screen if any button on the front panel is pressed while viewing the TV.

Note : The display **Child lock On** will not appear on the screen if any button on the front panel is pressed while displaying the menus.

Cinema

When you watch the movie, this function adjusts the set to the best picture appearance.

This function works in the following mode : COMPONENT 480i.

1. Press the **MENU** button and then **▲ / ▼** button to select the **SPECIAL** menu.

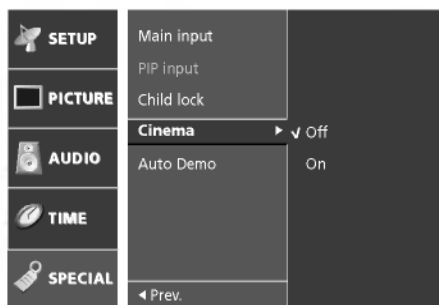

2. Press the **▶** button and then **▲ / ▼** button to select **Cinema**.
3. Press the **▶** button and then **▲ / ▼** button to select a picture setting on the **Cinema** pull-down menu.
4. Press the **OK** or **◀** button.
5. Repeatedly press the **MENU** button to return to normal TV viewing.

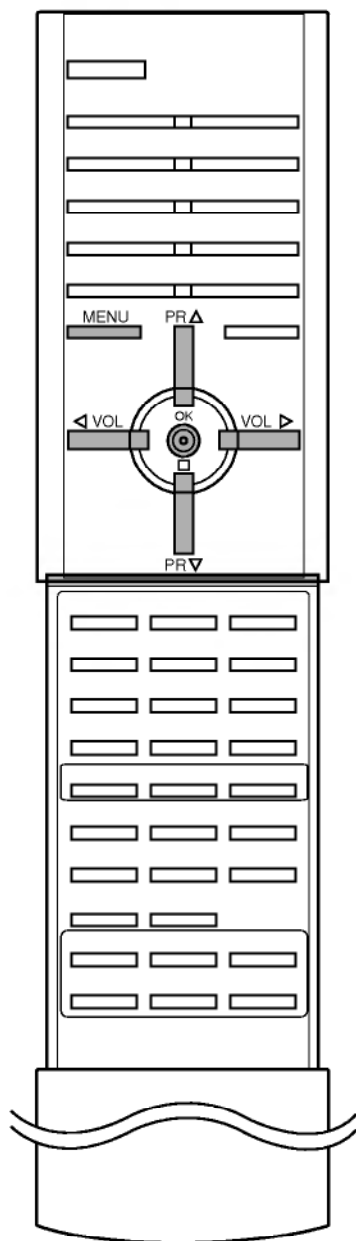

SPECIAL Menu

Auto Demo

Use to scan the features and menu options available on your TV.

1. Press the **MENU** button and then **▲ / ▼** button to select the **SPECIAL** menu.
2. Press the **▶** button and then **▲ / ▼** button to select **Auto Demo**.

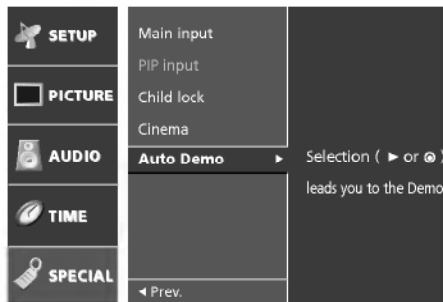

3. Press the **▶** or **OK** button to begin **Auto Demo**.
4. To stop **Auto Demo**, press the **CANCEL/EXIT** button.

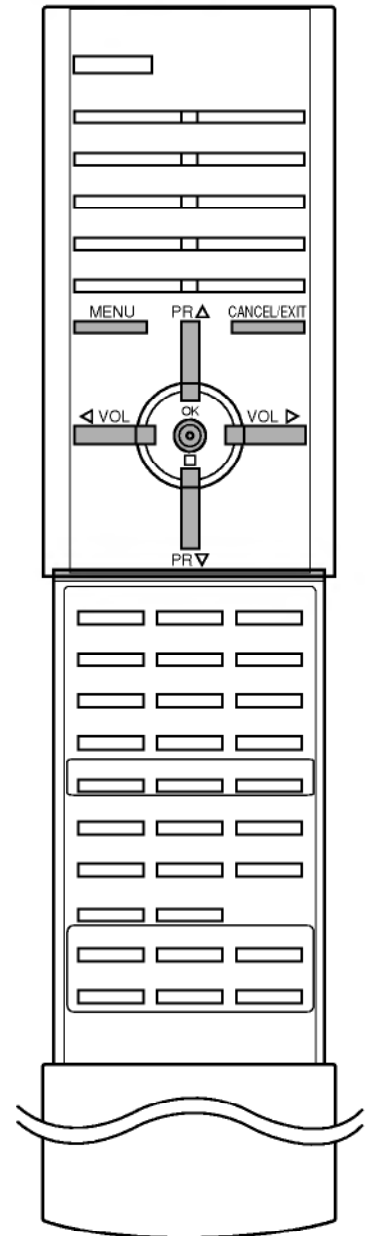
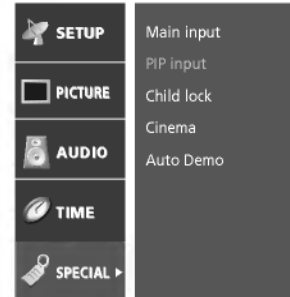

Picture In Picture (PIP) Function

Option :

PIP (Picture in Picture) displays a picture within a picture.

On and off

Press the **PIP** button to switch on the sub picture.

Press **CANCEL/EXIT** button to switch it off.

Each press of **PIP** button changes the screen display as shown below.

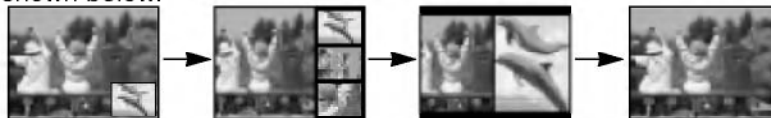

Note : When the sub picture size is 1/2 of the main picture, the picture quality might get poor.

Input mode selection for sub picture

Press the **INPUT** button to select the input mode for the sub picture.

Each time this button is pressed, each input mode for the sub picture is displayed as shown below.

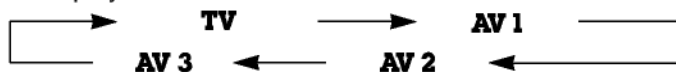

Note : When the PIP function is switched on, you can also adjust it in the Special menu.

Swapping between main and sub pictures

Press the **SWAP** button to exchange the main and sub pictures.

Note :

- a. When the main picture is TV or AV modes, the swapping is available.
- b. In the programme scan mode, you are available to the swapping in TV mode for main picture.

Programme selection for sub picture

The sub picture programme selection is available when the sub picture is TV mode. Press the **PR +/-** buttons to select a programme for the sub picture.

Sub picture size

Repeatedly press the **SIZE** button to select the desired sub picture size. The sub picture appears as 1/9 size of the main picture, followed by 1/16. With **SIZE** button in PIP mode, sub picture is adjusted.

Sub picture freeze

Press the **STILL** button to freeze motion of the sub picture. Press this button again to restore motion.

Sub picture position change

Press the **POSITION** button repeatedly until desired position is achieved. The sub picture move clockwise. POSITION function doesn't operate in POP and twin picture mode.

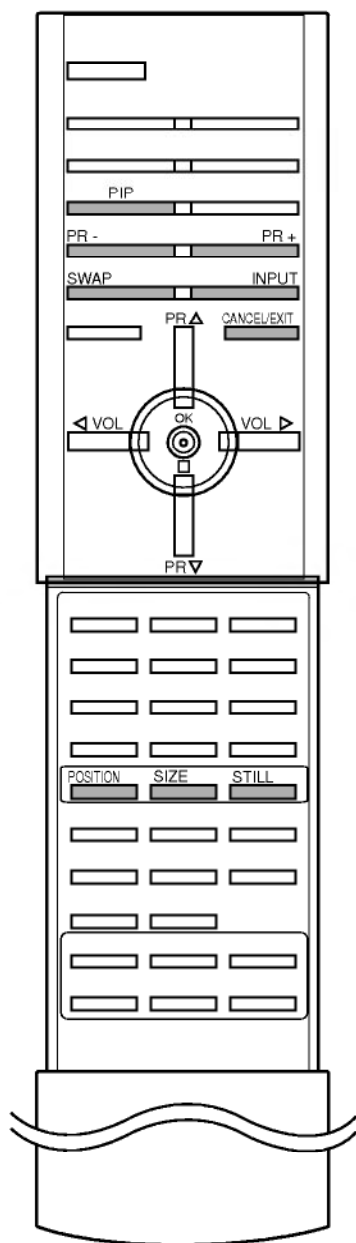

Teletext (option)

Teletext (or TOP text) is an optional function, therefore only a set with the teletext system can receive the teletext broadcast.

Teletext is a free service broadcast by most TV stations which gives up-to-the-minute information on news, weather, television programmes, share prices and many other topics.

The teletext decoder of this TV can support the SIMPLE, TOP and FASTEXT systems. SIMPLE (standard teletext) consists of a number of pages which are selected by directly entering the corresponding page number. TOP and FASTEXT are more modern methods allowing quick and easy selection of teletext information.

Switch on/off

Press the **TEXT** button to switch to teletext.

If TV and text picture are displayed half and half of the screen, press the **TEXT** button again to display text picture fully.

The initial page or last page appears on the screen.

Two page numbers, TV station name, date and time are displayed on the screen headline. The first page number indicates your selection, while the second shows the current page displayed.

Press the **TEXT** button to switch off teletext. The previous mode reappears.

SIMPLE text

Page selection

1. Enter the desired page number as a three digit number with the **NUMBER** buttons. If during selection you press a wrong number, you must complete the three digit number and then re-enter the correct page number.
2. The **▲ / ▼** button can be used to select the preceding or following page.

Programming a colour button in LIST mode

If the TV is in SIMPLE text, TOP text or FASTEXT mode, press the **≡M** button to switch to LIST mode.

Four teletext page numbers of your choice can be colour coded and easily selected by pressing the corresponding coloured button on the remote control handset.

1. Press a coloured button.
2. Using the **NUMBER** buttons, select the page you wish to programme.
3. Press the **OK** button. The selected page is stored as the selected page number, blinking once to confirm this. From now on, you can select this page with the same coloured button.
4. The three other coloured buttons are programmed in this way.

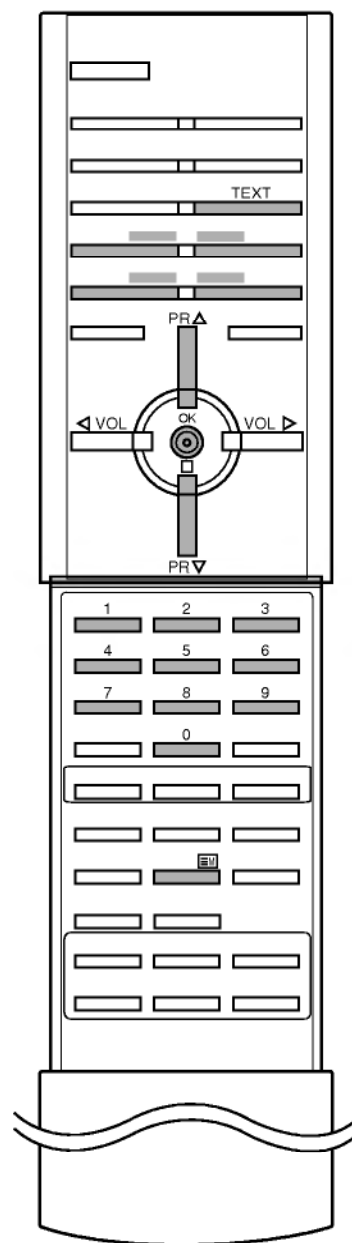

Teletext (option)

TOP text (option)

The user guide displays four fields-red, green, yellow and blue at the bottom of the screen. The yellow field denotes the next group and the blue field indicates the next block.

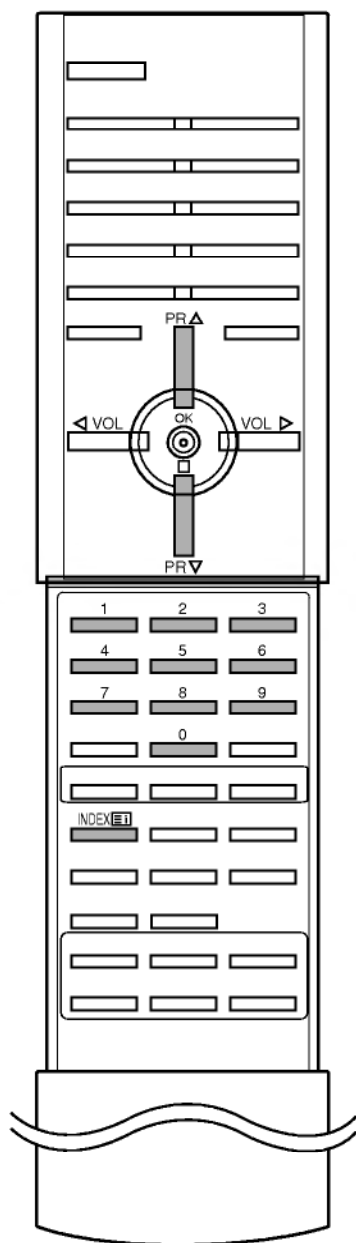

Block / group / page selection

1. With the blue button you can progress from block to block.
2. Use the yellow button to proceed to the next group with automatic overflow to the next block.
3. With the green button you can proceed to the next existing page with automatic overflow to the next group. Alternatively the ▲ button can be used.
4. The red button permits to return to previous selection. Alternatively the ▼ button can be used.

Direct page selection

Corresponding to the SIMPLE teletext mode, you can select a page by entering it as a three digit number using the NUMBER buttons in TOP mode.

FASTTEXT

The teletext pages are colour coded along the bottom of the screen and are selected by pressing the corresponding coloured button.

Page selection

1. Press the  button to select the index page.
2. You can select the pages which are colour coded along the bottom line with the same coloured buttons.
3. Corresponding to the SIMPLE teletext mode, you can select a page by entering its three digit page number with the NUMBER buttons in FASTTEXT mode.
4. The ▲ / ▼ button can be used to select the preceding or following page.

Connection of external equipment

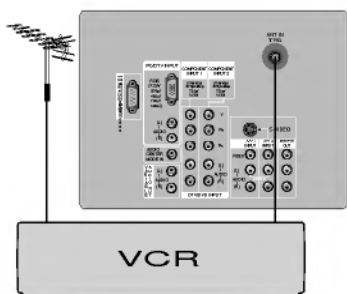

You can connect additional equipment, such as VCRs, camcorders etc. to your set. Here shown may be somewhat different from your set.

Aerial socket

1. Connect the RF out socket of the VCR to the aerial socket on the back of the set.
2. Connect the aerial cable to the RF aerial in socket of the VCR.
3. Store the VCR channel on a desired programme number using the 'Manual programme tuning' section.
4. Select the programme number where the VCR channel is stored.
5. Press the **PLAY** button on the VCR.

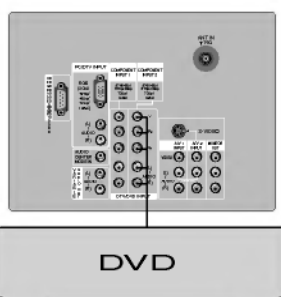

DVD input sockets

1. Connect the DVD output sockets (Y Cb Cr, Y Pb Pr, Y B-Y R-Y or Y P_B P_R) of the DVD player to the **DTV/DVD INPUT** sockets (Y P_B P_R) of the set.
2. Connect the audio cable from the DVD player to **DTV/DVD INPUT AUDIO** sockets of the set.
3. Press the **TV/AV** or **MULTIMEDIA** button to select **Component1** or **Component2**.
4. Press the **PLAY** button on the DVD player. The DVD playback picture appears on the screen.

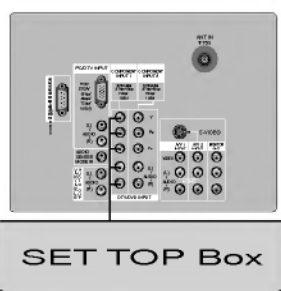

DTV input sockets

1. Connect the SET TOP output sockets to the **DTV/DVD INPUT** sockets (Y P_B P_R) of the set. (or, connect the HD-SET TOP with the D-Sub output socket to **PC/DTV INPUT** socket on the set and audio cable of the HD-SET TOP to the AUDIO sockets of **PC/DTV INPUT**.)
2. Connect the audio cable from the SET TOP to the **DTV/DVD INPUT AUDIO** sockets of the set.
3. Press the **TV/AV** or **MULTIMEDIA** button to select **Component1**, **Component2** or **RGB-DTV**.

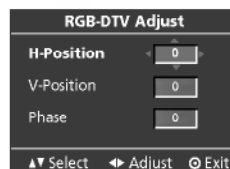
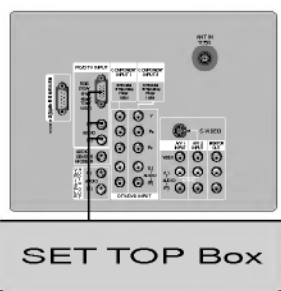

4. Press the **OK** button.
5. Press the **▲ / ▼** button to select **H-Position**, **V-Position** or **Phase**.
6. Press the **◀ / ▶** button to make appropriate adjustments.

Connection of external equipment

Audio/Video input sockets (option)

1. Connect the audio/video out sockets of the VCR to audio/video in sockets of the set.
2. Press the **TV/AV** button to select **AV1**, **AV2** or **AV3**.
3. Press the **PLAY** button on the VCR.
The VCR playback picture appears on the screen.

Note : If you have a mono VCR, connect the audio cable from the VCR to the **AUDIO L/MONO** socket of the set.

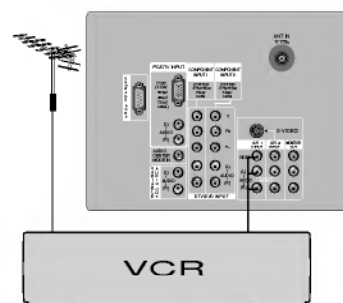

S-Video / Audio input sockets (option)

When connecting an VCR to the S-VIDEO socket, the picture quality will be further improved.

1. Connect the S-video socket of the VCR to the **S-VIDEO** socket of the set.
2. Connect the audio cable from the VCR to the AUDIO sockets of the **AV2 INPUT** or **AV3**.
3. Select **AV2** or **AV3** by pressing the **TV/AV** button repeatedly.
4. Press the **PLAY** button on the VCR.
The VCR playback picture appears on the screen.

Note : If both **S-VIDEO** and **VIDEO** sockets have been connected to the VCR simultaneously, only the **S-VIDEO** can be received.

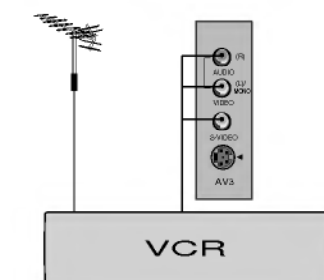

Monitor output sockets

Connect the audio/video in sockets of the other TV or monitor to **MONITOR OUTPUT** sockets of the set.

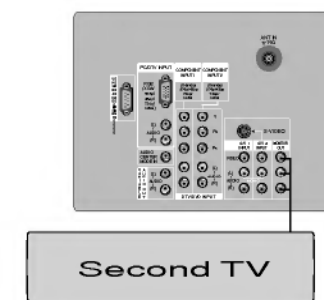
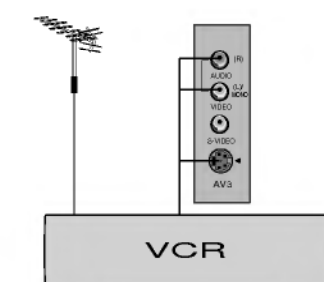
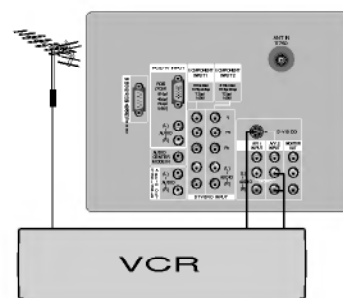

Connection of external equipment

Connecting PC

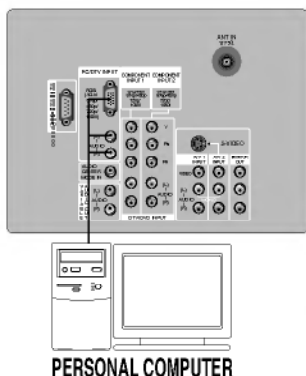

1. Connect the signal cable from the monitor output socket of the PERSONAL COMPUTER to the PC input socket of the set.
2. Connect the audio cable from the PC to the **PC/DTV INPUT AUDIO** sockets on the back of the set.
3. Press the **TV/AV** or **MULTIMEDIA** button to select **RGB-PC**.

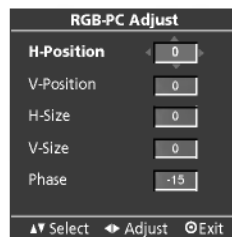

4. Switch on the PC, and the PC screen appears on the set. The set can be operated as the PC monitor.
5. Press the **OK** button and then **▲ / ▼** button to select the desired picture item.
6. Press the **◀ / ▶** button to make appropriate adjustments.

H-Position / V-Position

This function is to adjust picture to left/right and up/down as you prefer.

H-Size / V-Size

This function is to adjust picture size to enlarges or reduces as you prefer.

Phase

This function allows you to remove any horizontal noise and clear or sharpen the image of characters.

Note : Some signal from some graphics boards may not function properly. If the results are unsatisfactory, adjust your monitor's position, size and phase manually.

7. Press the **OK** button to store it for the PC monitor picture.

Note : Connect PC to the PC input sockets of the set after changing the resolution of PC.

Displayable Monitor Specification

MODE	Resolution	Horizontal Frequency(KHz)	Vertical Frequency(Hz)
EGA	640x350	31.468	70.09
VGA	640x480	31.469	59.94
	640x480	37.861	72.80
SVGA	640x480	37.500	75.00
	800x600	35.156	56.25
	800x600	37.879	60.31
XGA	800x600	48.077	72.18
	800x600	46.875	75.00
	1024x768	48.363	60.00
XGA	1024x768	56.476	70.06
	1024x768	60.023	75.02

(Synchronization input form : separate)

NOTE

NOTE

