



LCoS Projection TV OWNER'S MANUAL



Money Isn't All You're Saving

Please read this manual carefully before operating your set.
Retain it for future reference.
Record model number and serial number of the set.
See the label attached on the back cover and quote this information to your dealer when you require service.

Model number :
Serial number :

Safety Instructions

Power

This set operates on an AC mains supply, the voltage is as indicated on the label on the back cover. Never apply DC power to the set. In the event of thunderstorms or powercuts, please pull out the aerial and mains plugs.

Warning

To prevent fire or shock hazard, do not expose the set to rain or moisture.
Do not place anything containing liquid on top of the set, this may cause a fire or could give an electric shock.

Service

Never remove the back cover of the set as this can expose you to very high voltage and other hazards. If the set does not operate properly, unplug it and call your dealer.

Aerial

Connect the aerial cable to the socket marked +75 Ω on the back cover. For the best reception an outdoor aerial should be used.

Location

Position your set so that no bright light or sunlight falls directly onto the screen. Care should be taken not to expose the set to any unnecessary vibration, moisture, dust or heat. Also ensure that the set is placed in a position to allow a free flow of air. Do not cover the ventilation openings on the back cover.

Avoid having a fixed image remain on the screen for a long period of time. Typically a frozen still picture from a VCR, 4:3 picture format or if a CH label is present; the fixed image may remain visible on the screen.

**TO AVOID BURNING IMAGE INTO THE DISPLAY, DO NOT HAVE A STILL IMAGE ON SCREEN FOR EXTENDED PERIOD OF TIME.
IMAGE AFTER BURN WILL NOT BE COVERED UNDER WARRANTY ie. Menus, Video games, Borders or LOGOS**

Contents

Safety Warnings	
Safety Instructions	2
Introduction	
Remote Control Key Functions	4
Location and Function of Controls	5~6
Installation	
External Equipment Viewing Setups	7~11
HDMI	12~13
Operation	
Turning on the Set	14
Programme selection	14
Volume adjustment	14
Mute function	14
Channel Menu Options	
Auto Programme Tuning	15
Manual Programme Tuning (In Digital mode)	15
Manual Programme Tuning (In Analogue mode)	16
Assigning a station name (In Analogue mode only)	16
Fine tuning (In Analogue mode only)	16
Booster	16
Digital signal strength (In Digital mode only)	17
Programme Edit	17
Calling up the Programme Table	17
Picture Menu Options	
PSM (Picture Status Memory)	18
Picture adjustment	18
Adjusting Auto Colour Control	18
Video preset	19
ACE (Advanced Contrast Enhancement)	19
APM (Adaptive Picture Mode)	19
Audio Menu Options	
SSM (Sound Status Memory)	20
AVL (Auto Volume Leveler)	20
Sound adjustment	20
Front surround	21
Speaker adjustment	21
Sound output selection (In Analogue mode only)	21
Stereo reception (In Analogue mode only)	21
Time Menu Options	
Auto clock setup	22
Manual clock setup	22
Setting the On/Off time	22
Sleep timer	23
Auto sleep	23
Special Menu Options	
Main Picture Source Selection	24
Subtitle (In Digital mode only)	24
Child Lock	24
Picture format	25
Cinema	25
Auto Demo	25
Lock Menu Options	
Lock setup	26
PIP (Picture-In-Picture) / POP / Twin Picture	
On and off	27
Input mode selection for sub picture	27
Sub picture position change	27
Programme selection for sub picture	27
Swapping between main and sub picture	27
Adjusting main and sub picture sizes for Twin Picture	27
POP (Picture-out-of-Picture: Channel Scan)	27
Teletext (option)	
Switch on/off	28
SIMPLE Text (option)	28
TOP Text (option)	28
FASTEXT	29
Special Teletext Functions	29
EPG (Electronic Programme Guide) (In Digital mode only)	30
XSTUDIO	
Notes on Memory Card	31~34
JPEG File Viewing Options	35~39
MP3 File Playing Operation	40~43
Miscellaneous	
Programming the Remote	44
Programming Codes	44
Replacing the Lamp	45
Troubleshooting Checklist	46
Maintenance	47
Product Specifications	47

After reading this manual, keep it in a place where the user can refer to easily.

DVB[®]
Digital Video
Broadcasting

DVB is a registered trademark of the DVB Project

Remote Control Key Functions

- When using the remote control aim it at the remote control sensor of the set.
- There may be a defect in operation of this remote control in an excessively bright room when viewing this set.

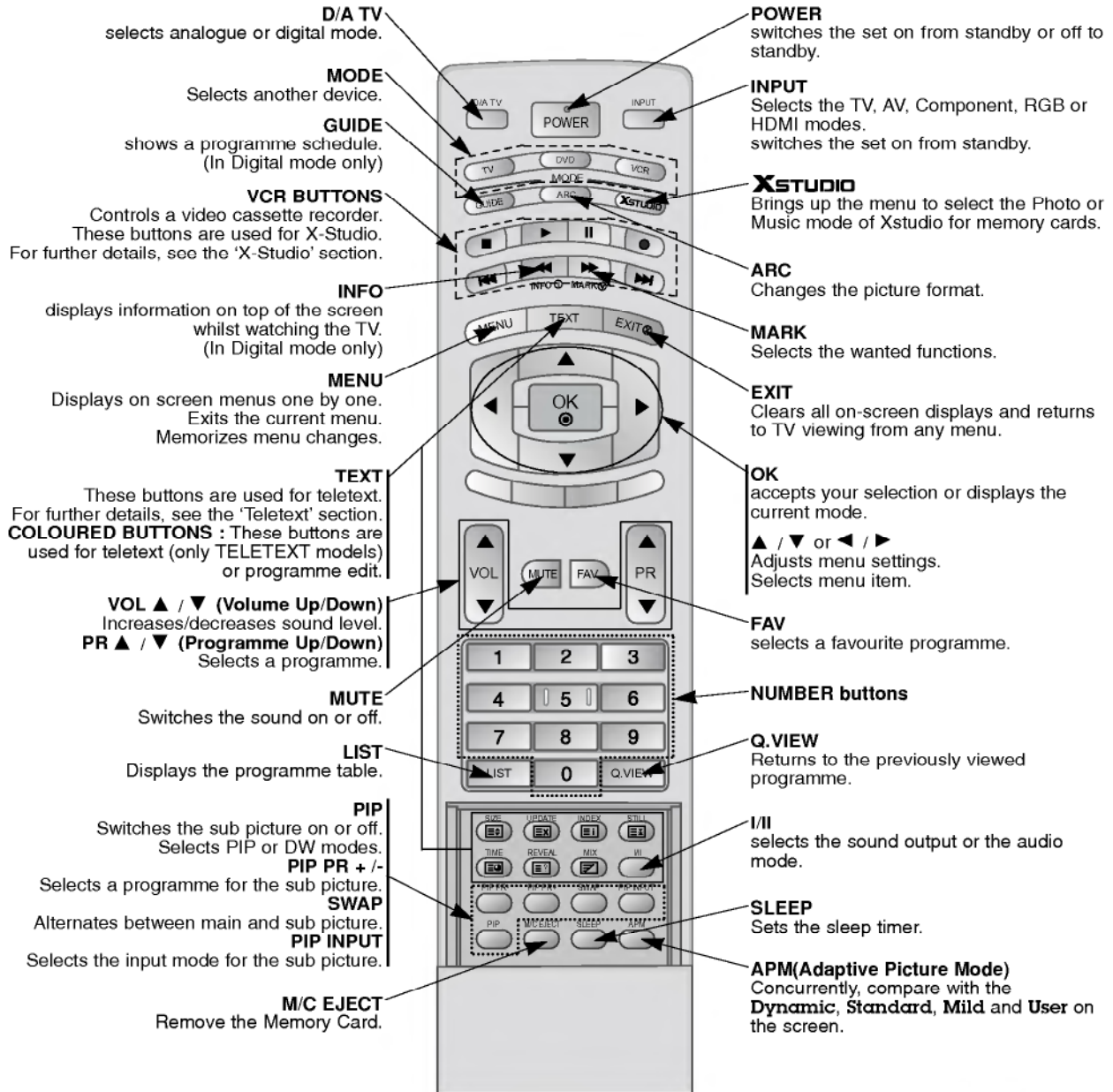

Installing Batteries

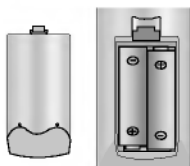

- Open the battery compartment cover on the back side and insert the batteries with correct polarity.
- Install two 1.5V alkaline batteries of AA type. Don't mix used batteries with new batteries.

Location and Function of Controls

- Shown is a simplified representation of the set.
- What is shown here may be somewhat different from your set.

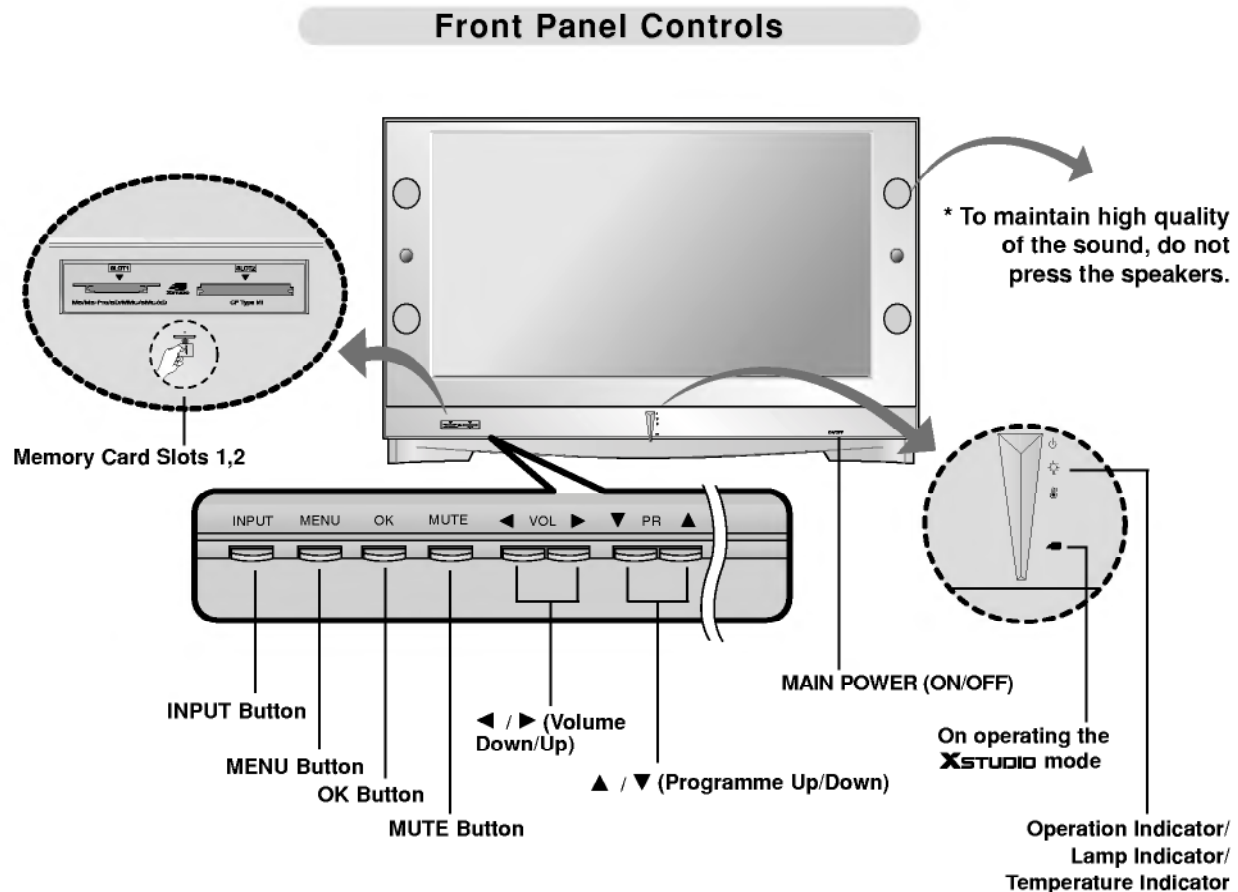

Function Status Indicators

- Lamp indicator, operation indicator, and temperature indicator located below the front panel controls, reveal the operating status of the LCoS projection TV.

Operation Indicator	Off	Power Cord is not connected.
	Red	Power Cord is connected, TV is in standby mode.
	Green	TV turns on.
	Red (blinking)	Power Cord is connected, TV is in booting sequence.
Lamp Indicator	White (Rolling)	Preparing operation in standby mode.
	Orange	Projection lamp is reaching the end of its life and needs to be replaced with a new lamp. Contact your service center.
	Red (blinking)	There is a problem with the lamp or around it. Contact an authorized service center.
Temperature Indicator	Green (blinking)	The lamp cover is not closed.
	Orange	The projection TV is overheating. Check the blocked vents of the Projection TV .
	Red	The projection TV shuts down due to overheating.
	Red (blinking)	The projection TV shuts down, check the cooling fan. Contact your service center.

Location and Function of Controls

Back Panel Controls

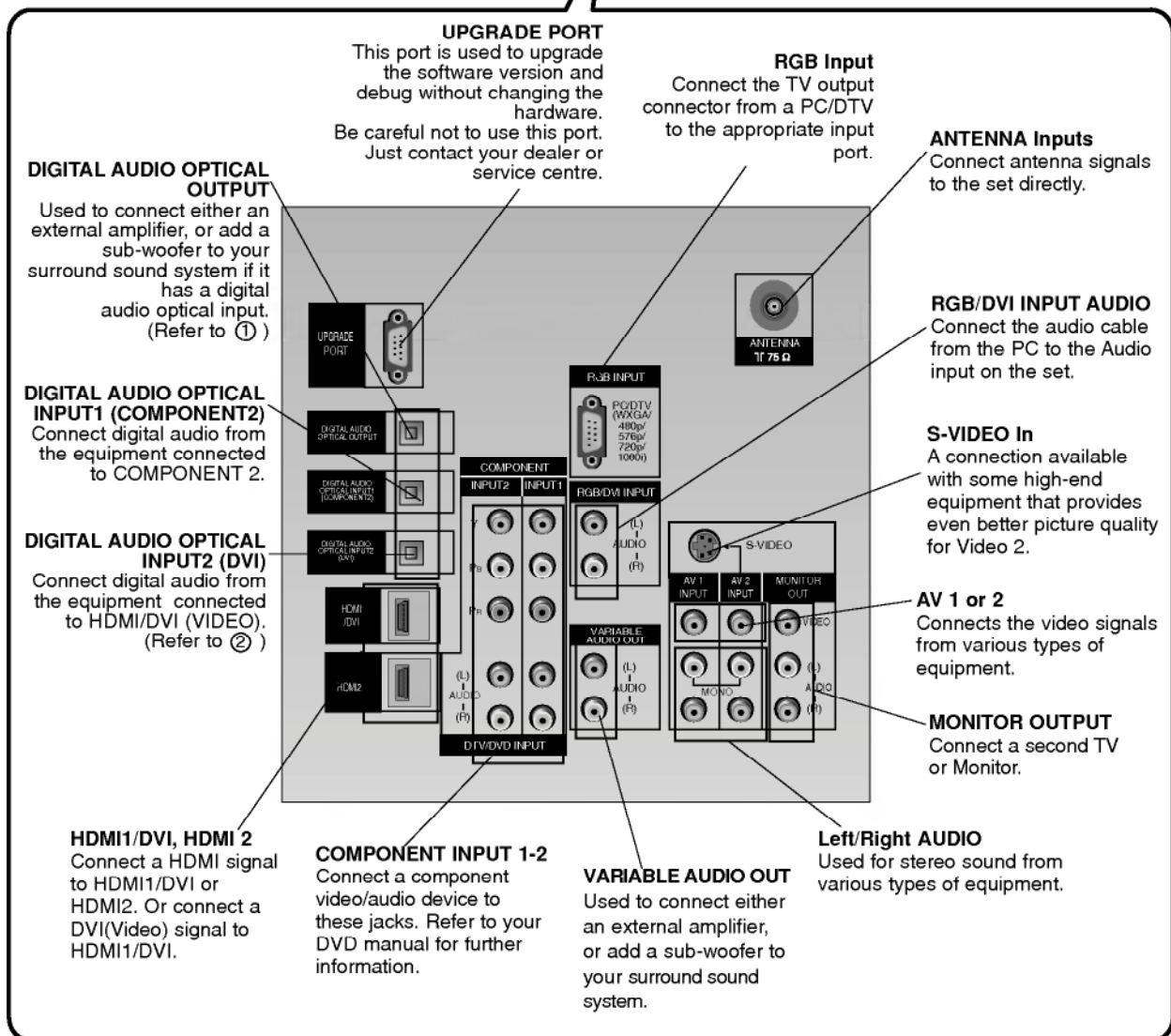
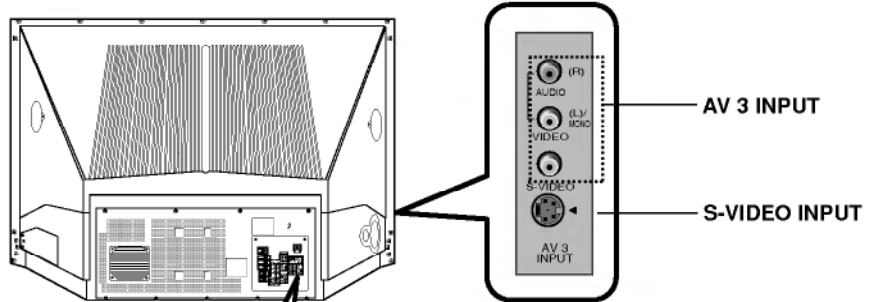

Notes: ① In standby mode, these port will not work.

② If the video is connected through HDMI-TO-HDMI cable, you don't need to connect digital audio. This port is used only when the video connected through DVI-TO-HDMI cable.

External Equipment Viewing Setups

Antenna Connection

- Be careful not to bend the bronze wire when connecting to an antenna port.

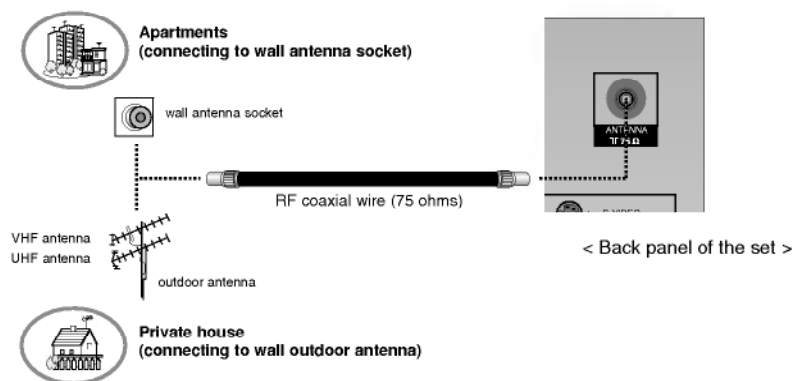

Watching VCR

- When connecting the Monitor to external equipment, match the colours of connecting ports (Video - yellow, Audio (L) - white, Audio (R) -red).
- Connect the VIDEO OUTPUT socket (yellow) to the VIDEO INPUT on the set.
- If you have a mono VCR, connect the audio cable from the VCR to the AUDIO (L/MONO) input on the set.
- If you connect an S-VIDEO VCR to the S-VIDEO input, the picture quality is improved; compared to connecting a regular VCR to the Video input.
- If a 4:3 picture format is used; the fixed image may remain visible on the screen.
- To avoid picture noise (interference), leave an adequate distance between the VCR and the set.

Watching TV programmes

- Turn the set on and select the programme you want.

Watching VCR

1. Use the **INPUT** button on the remote control to select **AV 1**, **AV 2** or **AV 3**.
- If both S-VIDEO and VIDEO sockets have been connected to the S-VHS VCR simultaneously, only the S-VIDEO can be received.
2. Insert a video tape into the VCR and press the **PLAY** button on the VCR.
(See VCR owner's manual)

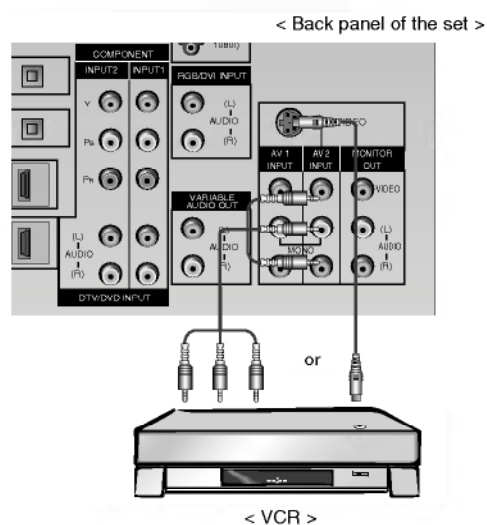

External Equipment Viewing Setups

Watching Cable TV

- After subscribing to a local cable TV station and installing a converter you can watch cable TV.
- For further information of cable TV, contact the local cable TV station.

< Back panel of the set >

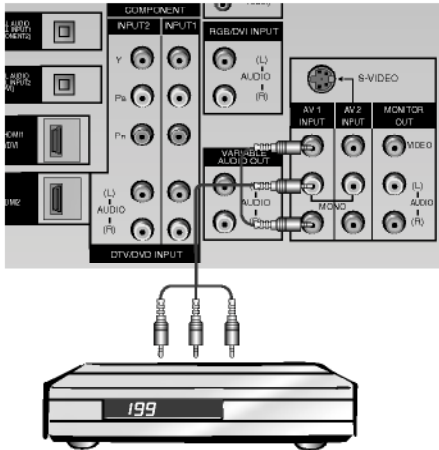

< Cable box >

To watch cable TV

1. Use the **INPUT** button on the remote control to select **AV 1**, **AV 2** or **AV 3**.
2. Tune the cable provided channels using the Cable set-top box.

Watching DVD

How to connect

1. Connect the DVD video outputs (Y, P_B, P_R) to the COMPONENT (Y, P_B, P_R) INPUT jacks on the set and connect the DVD audio outputs to the AUDIO INPUT jacks on the set, as shown in the figure.
2. If your DVD only has an S-Video output jack, connect this to the S-VIDEO input on the set and connect the DVD audio outputs to the AUDIO INPUT jacks on the set, as shown in the figure.

Note:

- a. If your DVD player does not have component video output, use S-Video.
- b. Digital Audio will not work for Component 1 input source. Digital Audio operation has priority if Digital Audio and AUDIO L/R are connected at the same time.

How to use

1. Turn on the DVD player, insert a DVD.
2. Use the **INPUT** button on the remote control to select **Component 1** or **Component 2**.
(If connected to S-VIDEO, select the **AV 2** or **AV 3** external input source.)
3. Refer to the DVD player's manual for operating instructions.

Component Input ports

You can get better picture quality if you connect DVD player with component input ports as below.

Component ports of the set	Y	P _B	P _R
Video output ports of DVD player	Y	P _b	P _r
	Y	B-Y	R-Y
	Y	C _b	C _r
	Y	P _B	P _R

< Back panel of the set >

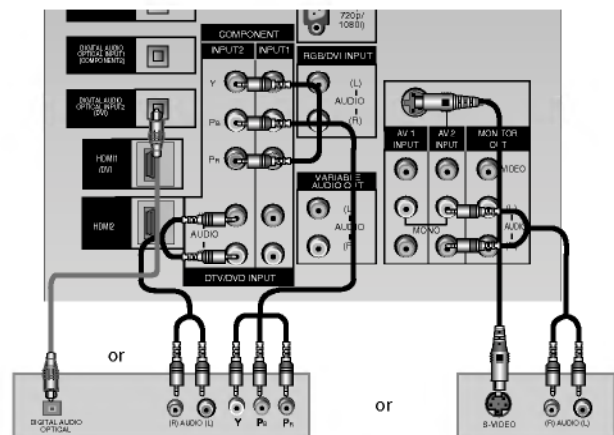

< DVD player >

Watching external AV source

- When connecting the set to an external source, match the colours of AUDIO/VIDEO input jacks on the set with the output jacks on the audio/video equipment: Video = yellow, Audio (Left) = white, Audio (Right) = red.

< Back panel of the set >

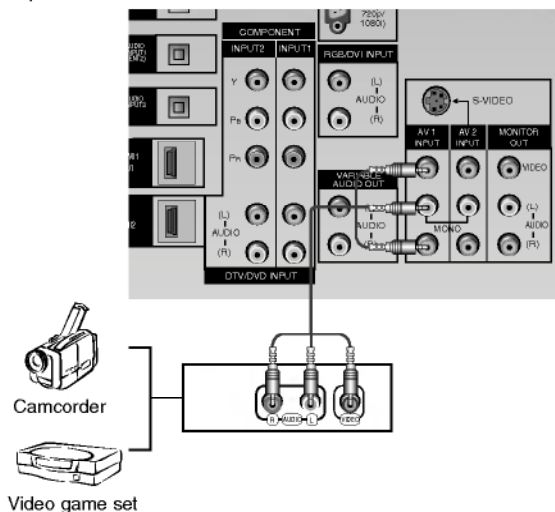

How to use

1. Use the **INPUT** button on the remote control to select **AV 1**, **AV 2** or **AV 3**.
2. Operate the corresponding external equipment. See external equipment operating guide.

Watching DTV with Set-top box

- This set can receive Digital Free to air/Cable signals without an external digital set-top box. However, if you do receive Digital signals from a digital set-top box or other digital external device, refer to the figure as shown below.

How to connect

1. Use the monitor's COMPONENT (Y, Pb, Pr) INPUT, RGB or HDMI jack for video connections, depending on your set-top box connector. Then, make the corresponding audio connections.

How to use

1. Turn on the digital set-top box. (Refer to the owner's manual for the digital set-top box.)
2. Use **INPUT** button on the remote control to select **Component 1**, **Component 2**, **RGB-DTV**, **HDMI1/DVI** or **HDMI2**.

Input signal from Digital Set-top box

Mode	Terminal	Component	RGB (DTV)	HDMI/DVI (DTV)
480i		○	X	X
576i		○	X	X
480p		○	○	○
576p		○	○	○
720p		○	○	○
1080i		○	○	○

< Back panel of the set >

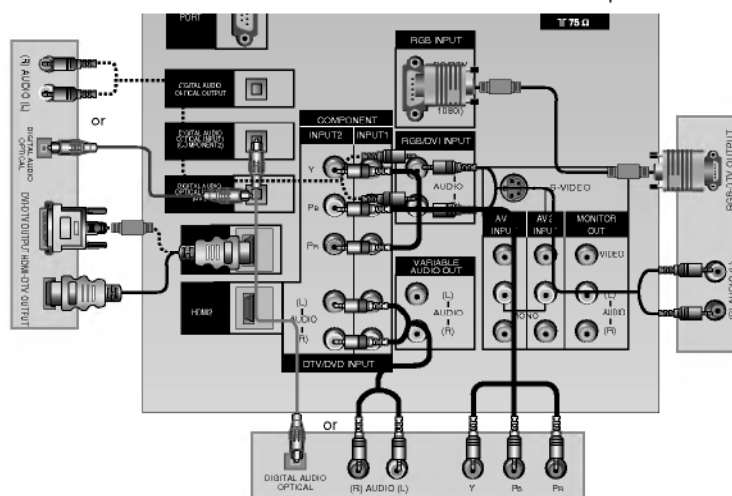

< Digital Set-top Box >

External Equipment Viewing Setups

Connecting PC

- To enjoy vivid picture and sound, connect a PC to the set.
- Avoid keeping a fixed image on the set's screen for a long period of time. The fixed image may become permanently imprinted on the screen; use a screen saver when possible.
- Connect PC to the RGB INPUT or HDMI/DVI INPUT port of the set; change the resolution output of PC accordingly.
- There might be noise according to some resolution, vertical pattern, contrast or brightness in PC mode. Change the PC mode into another resolution or change the refresh rate into another rate or adjust the brightness and contrast on the menu until the picture is clean. If the refresh rate of the PC graphic card can not be changed, change the PC graphic card or consult it to the manufacturer of the PC graphic card.
- The synchronization input waveform for Horizontal and Vertical frequencies are separate.

Setup Instructions to Connect a PC to your set

- We recommend using 1024x768, 60Hz for the PC mode, they provide the best picture quality.
- If the resolution of PC is over XGA, there will be no picture on the set.
- Connect the signal cable from the monitor output port of the PC to the RGB INPUT port of the set or the signal cable from the HDMI or DVI output port of the PC to the HDMI/DVI INPUT port on the set.
- Connect the audio cable from the PC to the Audio input on the set. (Audio cables are not included with the set).
- If using a sound card, adjust PC sound as required.
- This set uses a VESA Plug and Play Solution. The set provides EDID data to the PC system with a DDC protocol. The PC adjusts automatically to use this set.
- DDC protocol is preset for HDMI (Digital RGB) mode.
- If required, adjust the settings for Plug and Play functionality.
- If graphics card on the PC does not output analog and digital RGB simultaneously, connect only one of RGB INPUT or HDMI INPUT to display the PC on the set.
- If graphic card on the PC does output analog and digital RGB simultaneously, set the set to either RGB or HDMI ; (the other mode is set to Plug and Play automatically by the set.)
- DOS mode may not work depending on video card if you use a HDMI to DVI cable.
- When you use too long RGB-PC cable, there might be noise on the screen. We recommend using under 5m of the cable. It provides the best picture quality.

PC Setup

1. Turn on the display by pressing the **POWER** button on the set's remote control.
2. Use the **INPUT** button on the remote control to select the **RGB**, **HDMI1/DVI** or **HDMI2** input source.
3. Turn on the PC and apply power to the set.
4. Set the resolution output of the PC to XGA or under (1024 x 768, 60Hz).

< Back panel of the set >

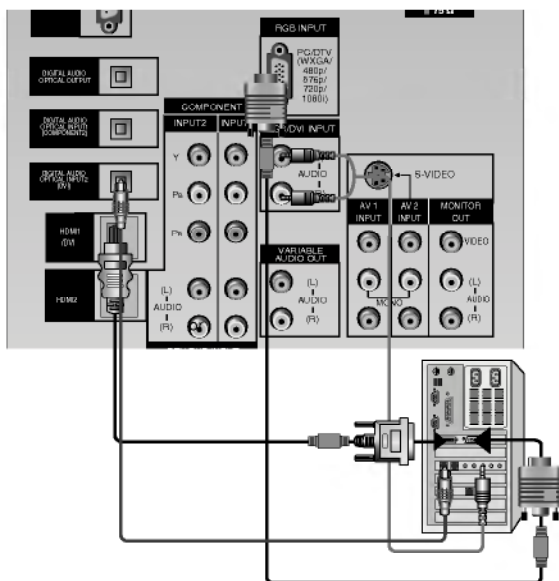

Displayable Monitor Specification

RGB / HDMI/DVI mode

Resolution	Horizontal Frequency(KHz)	Vertical Frequency(Hz)
640x350	31.468	70.09
	31.469	59.94
640x480	37.861	72.80
	37.500	75.00
800x600	35.156	56.25
	37.879	60.31
	48.077	72.18
1024x768	46.875	75.00
	48.363	60.00
	56.476	70.06
1280x720	60.023	75.02
	45.000	60.00
1280x768	48.363	60.00

- It's supported to 640x350, 640x480, 800x600, 1024x768 in HDMI/DVI mode.

Screen Adjustments

- This function works in the following mode:

Component 1, Component 2, RGB-PC, RGB-DTV, HDMI1/DVI or HDMI2

1. Press the **OK** button and then **▲ / ▼** button to select the desired picture item.
2. Press the **▶** button and then **◀ / ▶** or **▲ / ▼** button to make appropriate adjustments.

Position

This function is to adjust picture to left/right and up/down as you prefer.

Phase (Component 1, Component 2, RGB-PC or RGB-DTV mode) & SIZE (RGB-PC, HDMI1/DVI-PC or HDMI2-PC mode only)

This function allows you to remove any horizontal noise and clear or sharpen the image of characters.

To correct the screen size, adjust **SIZE**.

- The adjustment range of **Phase** is 0 ~ 31.

Note : Some signal from some graphics boards may not function properly. If the results are unsatisfactory, adjust your monitor's position, size and phase manually.

Reset

This function allows you to return to the good picture reproduction programmed at the factory and cannot be changed.

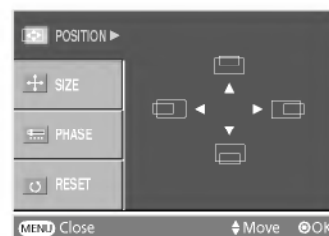

Digital Audio Output

< Back panel of the set >

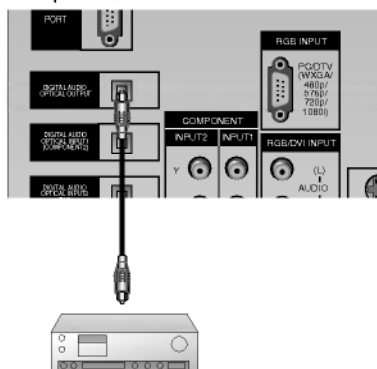

- Send the set's audio to external audio equipment (stereo system) via the Digital Audio Output (Optical) port.

Caution: Do not look into the optical output port. Looking at the laser beam may damage your vision.

How to connect

1. Connect one end of an optical cable to the TV Digital Audio (Optical) Output port.
2. Connect the other end of the optical cable to the digital audio (optical) input on the audio equipment.
3. Set the "TV speaker option - Off" in the AUDIO menu. Refer to page 21. See the external audio equipment instruction manual for operation.

Monitor Out Setup

- The set has a special signal output capability which allows you to hook up a second TV or monitor.

Connect the second TV or monitor to the set's MONITOR OUTPUT. See the Operating Manual of the second TV or monitor for further details regarding that device's input settings.

Note: Digital, Component 1/2, RGB-PC/RGB-DTV, HDMI1/DVI or HDMI2 input sources cannot be used for Monitor video out.

< Back panel of the set >

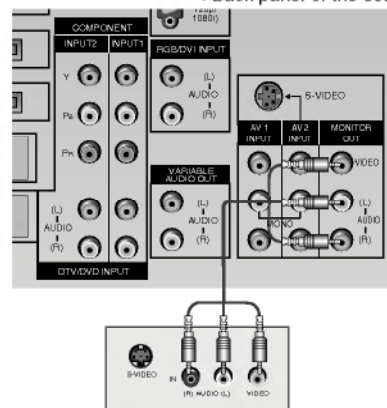



- HDMI™, the HDMI logo and High-Definition Multimedia Interface are trademarks or registered trademarks of HDMI Licensing.
- This set can receive the High-Definition Multimedia Interface (HDMI) or Input of Digital Visual Interface(DVI).
- This set supports HDCP (High-bandwidth Digital Contents Protection) Protocol for the set (480p, 576p, 720p, 1080i) modes.
- When you connect to HDMI1/DVI Source devices (DVD Player, STB or PC) that support AUTO HDMI/DVI Plug & Play, this sets the HDMI1/DVI source devices automatically.
After reading HDMI1/DVI source devices, using Display Data Channel (DDC) Protocol, Extended Display Identification Data (EDID) stored in the set is used.
If HDMI1/DVI Source devices do not support AUTO HDMI/DVI, the resolution is set manually.
- When Source Devices have DVI Output Connector, you must connect audio with separated cable.(Refer to <How to connect>)

How to connect

1. When Source Devices (DVD Player or Set Top Box) support HDMI.
 - If Source Devices have HDMI Output Connector, Source Devices connect to the set with HDMI Cable .(not supplied with the product).
 - Because HDMI sends Digital Video and Audio with one cable, there is no need for Audio Cable when using HDMI Cable.
2. When Source Devices (DVD Player or Set Top Box) supports DVI.
 - If Source Devices have DVI Output Connector, Source Devices connect to the set with HDMI to DVI Cable (not supplied with the product).
 - In this case, Audio use other cable. When Source Devices have Analog Audio Output Connector, Audio input for RGB/DVI of the set connect to Audio Cable (not supplied with the product). And then you can listen to normal Audio.
3. When PC supports DVI.
 - If PC has a DVI Output Connector, Source Devices connect to the set with HDMI to DVI Cable (not supplied with the product).
 - If the graphics card on the PC does not output analog RGB and DVI simultaneously, connect only one of either RGB Input or HDMI/DVI Input to display the PC on the set.
 - If the graphics card on the PC does output analog RGB and DVI simultaneously, connect to either RGB Input or HDMI/DVI Input to display the PC on the set; (the other mode is set to Plug and Play automatically by the set.)
 - Then, make the corresponding audio connections. If using a sound card, adjust the PC sound as required.
 - In this case, Audio use other cable. When PC (or sound card of PC) have Analog Audio Output Connector, Audio input for RGB/DVI of the set connect to Analog Audio Cable (not supplied with the product). And then you can listen to normal Audio.

Reference

Cable sample

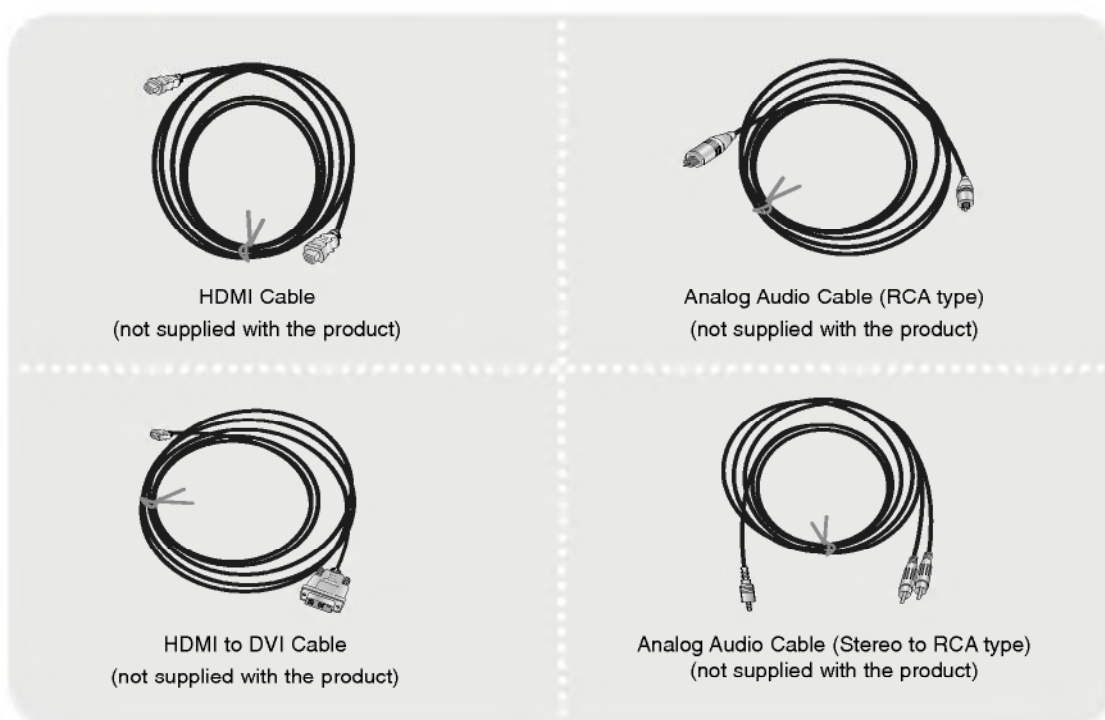

How to use

1. Connect the HDMI1/DVI Source Devices(DVD Player or Set Top Box or PC) and the set.
2. Turn on the display by pressing the POWER button on the set and HDMI/DVI Source Devices remote control.
3. Select HDMI1/DVI Input source in Main Input option of SPECIAL menu.
4. Check the image on your set. There may be noise associated with the resolution, vertical pattern, contrast or brightness in HDMI/DVI Source Devices. If noise is present, change the HDMI/DVI Source Devices to another resolution, change the refresh rate or adjust the brightness and contrast on the menu until the picture is clear. If the refresh rate of the PC graphics card can not be changed, change the PC graphics card or consult the manufacturer of the PC graphics card.

Notes:

- Depending on the graphics card, DOS mode may not work if you use a HDMI to DVI Cable.
- Avoid keeping a fixed image on the set screen for a long period of time. The fixed image may become permanently imprinted on the screen. Use the Orbiter screen saver when possible.
- When Source Devices connected HDMI1/DVI Input output the set Resolution(480p, 576p, 720p, 1080i), the set Display fit EIA/CEA-861-B Specification to Screen. If not, refer to the Manual of HDMI1/DVI Source Devices or contact your service centre.
- In case of HDMI/DVI Source Devices are not connected, Cable or poor cable connection, "No Signal" OSD display in HDMI/DVI Input. And In case of Video Resolution not supported when output is HDMI/DVI Source Devices, "Invalid format" OSD display. Refer to the Manual of HDMI/DVI Source Devices or contact your service centre.

Turning on the Set

- When using the remote control, aim it at its sensor on the set.
- In this manual, the OSD (On Screen Display) may be different from your set's because it is just an example to help you with the TV operation.

Turning on the set just after installation

1. Connect power cord correctly.
2. Press the **POWER** button on the set. At this moment, the set is switched to standby mode. Press the **INPUT, D/A TV, PR ▲ / ▼, NUMBER** button on the remote control or press the **INPUT, PR ▲ / ▼** button on the set front panel and then the set will switch on.

Initializing setup



If the OSD (On Screen Display) is displayed on the screen as figure after turning on the set, you can adjust the Auto Programme tuning, Time Zone selection or Password setting.

Note: It will automatically disappear after approx. 40 seconds unless a button is pressed.

Turning on the set (power cord is still connected)

1. If the power cord is connected and there is no indicators
 - Check that the power button is turned on.
2. If the set was turned off with the remote control and the **POWER** button on the set
 - Press the **POWER** button on the set or press the **POWER, INPUT, D/A TV, PR ▲ / ▼, NUMBER** button on the remote control to turn the set on.

Programme selection

You can select a programme number with the **PR ▲ / ▼** or **NUMBER** buttons.

Volume adjustment

Press the **VOL ▲ / ▼** button to adjust the volume.

Mute function

Press the **MUTE** button. The sound is switched off and the display

 Mute appears.

You can cancel it by pressing the **MUTE, VOL ▲ / ▼, I/II** button.

Channel Menu Options

Auto Programme Tuning

- Up to 100 TV stations can be stored in this set by programme numbers (0 to 99). Once you have preset the stations, you will be able to use the ▲ / ▼ or NUMBER buttons to scan the stations you programmed. Stations can be tuned using automatic or manual modes.
- In Digital mode up to 400 TV stations can be stored.

1. Press the **MENU** button and then ▲ / ▼ button to select the **SETUP** menu.
2. Press the ► button and then ▲ / ▼ button to select **Auto programme**.
3. Press the ► button to select **Storage from**. Select the beginning programme number with the ▲ / ▼ button or NUMBER buttons on the **Storage from** menu.
4. Press the ► button to select **To start**.
5. Press the ► button to begin auto programming. All receivable stations are stored.

Option: In Australia, if no station name can be assigned to a station, the channel number is assigned and stored as ----- followed by a number see 'Assigning a station name' section to assign the station name.

To stop auto programming, press the **MENU** button.

When auto programming is completed, the **Programme edit** menu appears on the screen. See the 'Programme Edit' section to edit the stored programme.

6. Press the **EXIT** button to return to normal TV viewing.

Note :

- a. To begin auto programming or manual programming, input a 4-digit password in Lock system. Be sure to remember this number!
- b. If you forgot your password, press '7', '7', '7', '7' on the remote control handset.

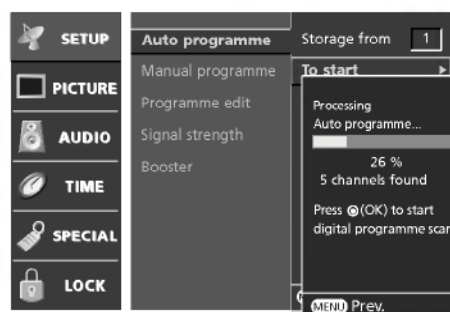
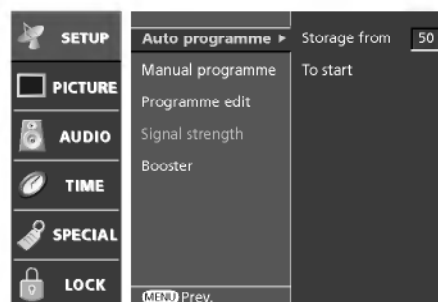

Manual Programme Tuning (In Digital mode)

- Manual programme lets you manually tune and arrange the stations in whatever order you desire. Also you can assign a station name with five characters to each programme number.

1. Press the **MENU** button and then ▲ / ▼ button to select the **SETUP** menu.
2. Press the ► button and then ▲ / ▼ button to select **Manual programme**.
3. Press the ► button to select the desired channel number with the ▲ / ▼ button.

When the programme is stored, the **Programme edit** menu appears on the screen. See the 'Programme Edit' section to edit the stored programme.

4. Press the **EXIT** button to return to normal TV viewing.

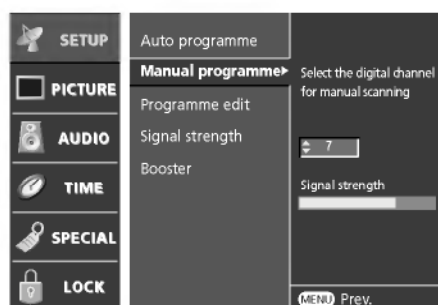

Channel Menu Options

Manual Programme Tuning (In Analogue mode)

- Manual programme lets you manually tune and arrange the stations in whatever order you desire. Also you can assign a station name with five characters to each programme number.

 1. Press the **MENU** button and then **▲ / ▼** button to select the **SETUP** menu.
 2. Press the **▶** button and then **▲ / ▼** button to select **Manual programme**.
 3. Press the **▶** button to select **Band**. Press the **▲ / ▼** button to select **V/UHF** or **Cable** as required.
 4. Press the **▶** button to select **Channel**. Select the desired channel number with the **▲ / ▼** button.
 5. Press the **▶** button to select **Search**. Press the **▲ / ▼** button to commence searching. If a station is found the search will stop.
 6. If this station is the one required, press the **◀ / ▶** button to select **Storage**. Select the desired programme number with the **▲ / ▼** button.
 7. Press the **OK** button to store it.
 8. To store another station, repeat steps 3 to 8.
 9. Press the **EXIT** button to return to normal TV viewing.

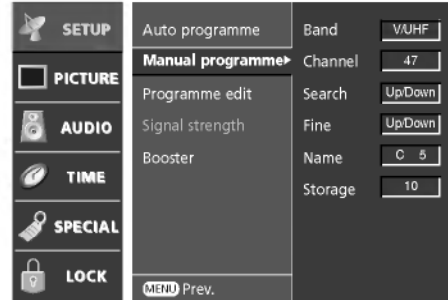

Assigning a station name (In Analogue mode only)

1. Repeat the 'Manual programme tuning' steps 1 to 2.
2. Press the **▶** button to select **Name**.
3. Press the **▲** button. You can use a blank, +, -, the numeric **0** to **9** and the alphabet **A** to **Z**. With the **▼** button you can select in the opposite direction.
4. Select the next position by pressing the **▶** button and then make your choice of the second character, and so on.
5. Press the **OK** button.
6. Press the **EXIT** button to return to normal TV viewing.

Fine tuning (In Analogue mode only)

- Normally fine tuning is only necessary if reception is poor.

 1. Repeat the 'Manual programme tuning' steps 1 to 2.
 2. Press the **▶** button to select **Fine**.
 3. Press the **▲ / ▼** button to fine tune for the best picture and sound.
 4. Press the **OK** button.
 5. Press the **EXIT** button to return to normal TV viewing. The finely tuned programme will be indicated by a yellow number during programme selection.

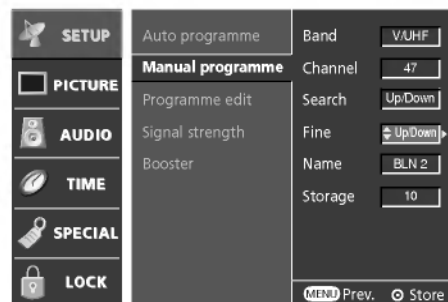

Booster

- If the reception is poor at the fringed area of TV signal, select **Booster** to **On**. When the picture condition is good, do not select **Booster** to **On**.

 1. Press the **MENU** button and then **▲ / ▼** button to select the **SETUP** menu.
 2. Press the **▶** button and then **▲ / ▼** button to select **Booster**.
 3. Press the **▶** button and then **▲ / ▼** button to select **On** or **Off** on the **Booster** pull-down menu.
 4. Press the **EXIT** button to return to normal TV viewing.

Digital signal strength (In Digital mode only)

- Reveals how strong your DTV signal is and whether you need to adjust your antenna.
 - The higher the signal strength, the less likely you are to experience picture degradation.
 - Digital DTV Signals; May not be available in all areas, nor broadcast all programmes.
1. Press the **MENU** button and then **▲ / ▼** button to select the **SETUP** menu.
 2. Press the **▶** button and then **▲ / ▼** button to select **Signal strength**.
View the on-screen signal strength monitor to see the quality of the signal being received.

Programme Edit

- This function enables you to delete or skip the stored programmes. Also you can move some stations to other programme numbers or copy a blank station data into the selected programme number.
1. Press the **MENU** button and then **▲ / ▼** button to select the **SETUP** menu.
 2. Press the **▶** button and then **▲ / ▼** button to select **Programme edit**.
 3. Press the **▶** button to display the **Programme edit** menu.

Deleting a programme (In Analogue mode only)

1. Select a programme to be deleted with the **▲ / ▼** or **◀ / ▶** button.
2. Press the **RED** button twice.
The selected programme is deleted, all the following programmes are shifted up one position.

Copying a programme (In Analogue mode only)

1. Select a programme to be copied with the **▲ / ▼** or **◀ / ▶** button.
2. Press the **GREEN** button.
3. Move the programme to the desired programme number with the **▲ / ▼** or **◀ / ▶** button.
4. Press the **GREEN** button again to move the programme.
All the following programmes are shifted down one position.

Moving a programme (In Analogue mode only)

1. Select a programme to be moved with the **▲ / ▼** or **◀ / ▶** button.
2. Press the **YELLOW** button.
3. Move the programme to the desired programme number with the **▲ / ▼** or **◀ / ▶** button.
4. Press the **YELLOW** button again to release this function.

Skipping a programme number

1. Select a programme number to be skipped with the **▲ / ▼** or **◀ / ▶** button.
2. Press the **BLUE** button. The skipped programme turns to blue.
3. Press the **BLUE** button again to release the skipped programme.
When a programme number is skipped it means that you will be unable to select it using the **PR ▲ / ▼** button during normal TV viewing. If you want to select the skipped programme, directly enter the programme number with the **NUMBER** buttons or select it in the programme edit or table menu.

Selecting favourite programme

1. Select your favourite programme number by pressing **▲ / ▼** or **◀ / ▶** buttons and then press the **FAV** button.
It will automatically include the selected programme into your favourite programmes list and a heart-mark will appear in front of that programme number. You can store up to 10 programmes.

Repeatedly press the **FAV** button to select stored favourite programmes in normal TV viewing.

Calling up the Programme Table

- You can check the programmes stored in the memory by displaying the programme table.

Displaying programme table

Press the **LIST** button to display the Programme table menu.
The programme table appears on the screen.

Note :

- a. You may find some blue highlighted programmes shown. They have been set up in the programme edit mode.
- b. Some programmes with the channel number shown in the programme table indicate there is no station name assigned.

Selecting a programme in the programme table

Select a programme with the **▲ / ▼** or **◀ / ▶** button.
The set switches to the chosen programme number.

Paging through a programme table

Pressing the **PR ▲ / ▼** button changes current page into previous/next page.

Press the **LIST** button to return to normal TV viewing.

Picture Menu Options

PSM (Picture Status Memory)

- This function adjusts the set to the best picture appearance.
- When adjusting picture options (contrast, brightness, colour, sharpness and tint) manually, PSM is automatically changed to **User**. (Tint operates only 60Hz AV input mode.)

1. Press the **MENU** button and then **▲ / ▼** button to select the PICTURE menu.
2. Press the **▶** button and then **▲ / ▼** button to select **PSM**.
3. Press the **▶** button and then use **▲ / ▼** button to select **Dynamic**, **Standard**, **Mild**, **Game** or **User** on the **PSM** pull-down menu. Picture options **Dynamic**, **Standard**, **Mild** and **Game** are preset and programmed for good picture quality at the factory and cannot be changed.
4. Press the **OK** button.
5. Press the **EXIT** button to return to normal TV viewing.

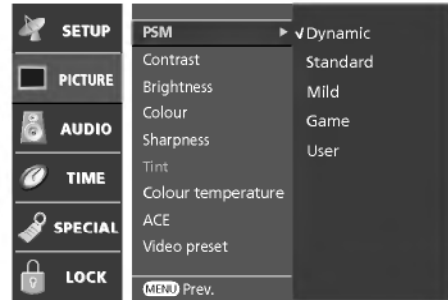

Picture adjustment

- You can adjust picture contrast, brightness, colour intensity, sharpness and tint (NTSC AV, COMPONENT 60Hz, RGB/HDMI/DVI-DTV 60Hz, RGB/HDMI/DVI-PC mode only) to the levels you prefer.

1. Press the **MENU** button and then **▲ / ▼** button to select the PICTURE menu.
2. Press the **▶** button and then **▲ / ▼** button to select the desired picture item.
3. Press the **▶** button and then **◀ / ▶** button to make appropriate adjustments, then it will be stored for the picture User.
4. Press the **OK** button.
5. Press the **EXIT** button to return to normal TV viewing.

Note : The adjustment for PICTURE menu (contrast, brightness, colour, sharpness and tint) affect both the main and sub picture in PIP or Twin Picture mode.

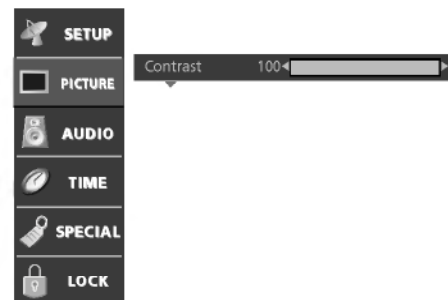

Adjusting Auto Colour Control

- Choose one of three automatic colour adjustments. Set to warm to enhance hotter colours such as red, or set to cool to see less intense colours with more blue.

1. Press the **MENU** button and then **▲ / ▼** button to select the PICTURE menu.
2. Press the **▶** button and then **▲ / ▼** button to select **Colour temperature**.
3. Press the **▶** button and then use **▲ / ▼** button to select the desired colour temperature.
4. Press the **OK** button.
5. Press the **EXIT** button to return to normal TV viewing.



ACE (Advanced Contrast Enhancement)

- In dark images, improve the luminosity contrast of black points.

1. Press the **MENU** button and then **▲ / ▼** button to select the **PICTURE** menu.
2. Press the **▶** button and then **▲ / ▼** button to select **ACE**.
3. Press the **▶** button and then use **▲ / ▼** button to select **On**.
 - To cancel **ACE** function, select **Off**.
5. Press the **EXIT** button to return to normal TV viewing.

Note: In Twin Picture mode, ACE function is disabled.

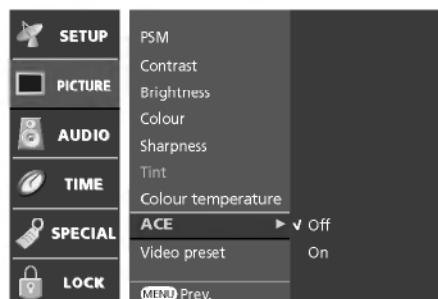

Video preset

- Use to quickly reset all the picture menu options to their original factory preset values.

APM (Adaptive Picture Mode)

- Allows a viewer to select their preferred picture mode after comparing the four different picture (**Dynamic**, **Standard**, **Mild** and **User**) settings.

1. Press the **APM** button once. As shown, the screen is divided into a 4-split screen.
2. Use the **▲ / ▼ / ◀ / ▶** button to navigate 4 Demo Pictures.
3. By pressing the **OK** button, you can select the desired mode.
4. Press the **EXIT** button to return to normal TV viewing.

Note:

- a. While operating the 4-split, any button except **APM**, **OK**, **EXIT**, **MUTE** button on the remote control are unavailable.
- b. APM screen will automatically disappear after approx. 40 seconds unless a button is pressed.



Audio Menu Options

SSM (Sound Status Memory)

- This function lets you enjoy the best sound without any special adjustment because the set has the appropriate sound option based on the programme content.
 - When adjusting sound options (treble and bass) manually, SSM is automatically changed to **User**.
1. Press the **MENU** button and then **▲ / ▼** button to select the AUDIO menu.
 2. Press the **▶** button and then **▲ / ▼** button to select **SSM**.
 3. Press the **▶** button and then **▲ / ▼** button to select **Standard, Music, Movie, Speech** or **User** on the **SSM** pull-down menu.
The sound **Standard, Music, Movie** and **Speech** are programmed for good sound reproduction at the factory and cannot be changed.
 4. Press the **OK** or **◀** button.
 5. Press the **EXIT** button to return to normal TV viewing.

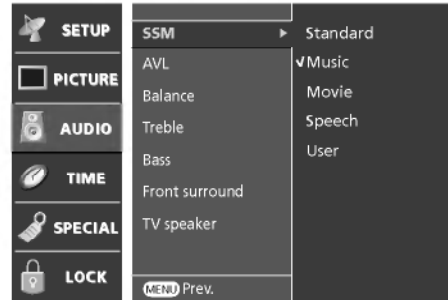

AVL (Auto Volume Leveler)

- If you select **AVL On**, the set automatically keeps on an equal volume level even if you change programmes.
1. Press the **MENU** button and then **▲ / ▼** button to select the AUDIO menu.
 2. Press the **▶** button and then **▲ / ▼** button to select **AVL**.
 3. Press the **▶** button and then **▲ / ▼** button to select **On** or **Off** on the **AVL** pull-down menu.
 4. Press the **OK** or **◀** button.
 5. Press the **EXIT** button to return to normal TV viewing.

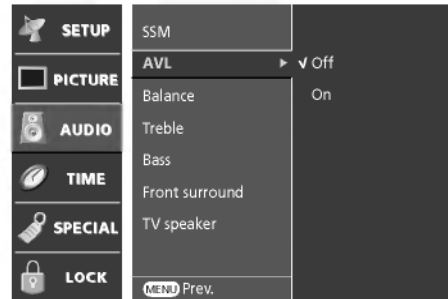

Sound adjustment

1. Press the **MENU** button and then **▲ / ▼** button to select the AUDIO menu.
2. Press the **▶** button and then use **▲ / ▼** button to select the desired sound item.
3. Press the **▶** button and then use **◀ / ▶** button to make appropriate adjustments.
4. Press the **OK** button.
5. Press the **EXIT** button to return to normal TV viewing.

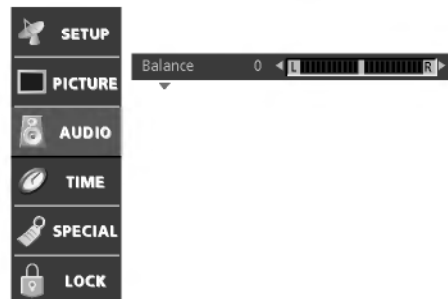

Front surround

1. Press the **MENU** button and then **▲ / ▼** button to select the **AUDIO** menu.
2. Press the **▶** button and then **▲ / ▼** button to select **Front surround**.
3. Press the **▶** button and then **▲ / ▼** button to select **Off** or **SRS TruSurround XT** on the **Front surround** pull-down menu.

SRS TruSurround XT

Takes advantage of any multi-channel format without adding extra speakers or equipment. Dialog clarity, bass enrichment, and the addition of stereo audio enhancement that produces an immersive sound experience from standard stereo material.

6. Press the **OK** button.
7. Press the **EXIT** button to return to normal TV viewing.



is a trademark of SRS Labs, Inc.

TruSurround XT technology is incorporated under license from SRS Labs, Inc.

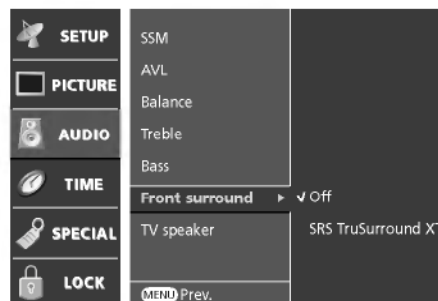

Speaker adjustment

- You can adjust internal speaker status.

1. Press the **MENU** button and then **▲ / ▼** button to select the **AUDIO** menu.
2. Press the **▶** button and then **▲ / ▼** button to select **TV speaker**.
3. Press the **▶** button and then **▲ / ▼** button to select **Off** or **On** on the **TV speaker** pull-down menu.
4. Press the **OK** button.
5. Press the **EXIT** button to return to normal TV viewing.

Note : In AV, RGB-PC/DTV and HDMI/DVI mode, internal speaker audio can be outputted even though there is no video signal.

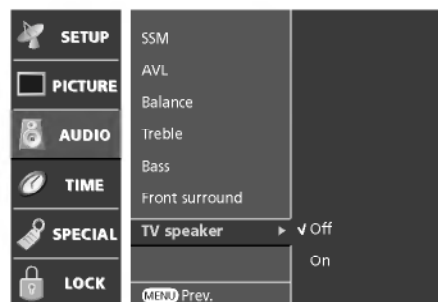

Sound output selection (In Analogue mode only)

- You can select output sound for the left and right loud speakers.

- This function works in the following mode:

AV 1/2/3, Component 1/2, RGB-PC/DTV, HDMI1/DVI or HDMI2

Repeatedly press the **I/II** button to select the sound output.

L+R : Audio signal from audio L input is sent to the left loud speaker and audio signal from audio R input is sent to the right loud speaker.

L+L : Audio signal from audio L input is sent to left and right loud speakers.

R+R : Audio signal from audio R input is sent to left and right loud speakers.

- Repeatedly press the **I/II** button to change the audio mode (MPEG or DOLBY DIGITAL) in Digital mode.

Stereo reception (In Analogue mode only)

Broadcast	On Screen Display
Mono	MONO
Stereo	MONO / STEREO

Mono sound selection

In stereo reception if the stereo signal is weak, you can switch to mono by pressing the **I/II** button twice. In mono reception the depth of sound is improved. To switch back to stereo, press the **I/II** button twice again.

Time Menu Options

Auto clock setup

- The time is automatically set from a digital channel signal.
- The digital channel signal includes information for the current time provided by the broadcasting station.
- Set the clock manually, if the current time is set incorrectly by the auto clock function.

1. Press the **MENU** button and then **▲ / ▼** button to select the **TIME** menu.
2. Press the **▶** button and then **▲ / ▼** button to select **Auto clock**.
3. Press the **▶** button and then **▲ / ▼** button to select **On**.
4. Press the **▶** button and then **▲ / ▼** button to select your viewing area time zone; **NSW/ACT, NT, TAS, WA, SA, QLD, or VIC**.
5. Press the **OK** or **◀** button.
6. Press the **EXIT** button to return to normal TV viewing.

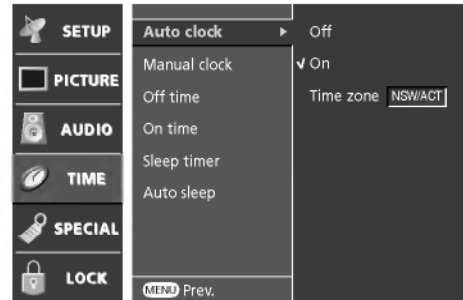

Manual clock setup

- If current time setting is wrong, reset the clock manually.

1. Press the **MENU** button and then **▲ / ▼** button to select the **TIME** menu.
2. Press the **▶** button and then **▲ / ▼** button to select **Manual clock**.
3. Press the **▶** button and then **◀ / ▶** button to select among the year, date, or time option.
Once selected, use the **▲ / ▼** button to set year, date, and time options.
4. Press the **OK** or **◀** button.
5. Press the **EXIT** button to return to normal TV viewing.

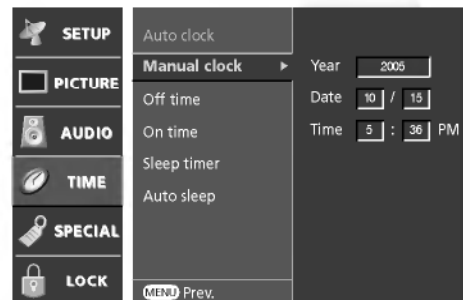

Setting the On/Off time

- Timer function operates only if current time has been already set.
- Off Time function overrides on Time function if they are set to the same time.
- The set must be in standby mode for the On Time to work.
- Two hours after the set is switched on by the on time function it will automatically switch back to standby mode unless a button has been pressed.

1. Press the **MENU** button and then **▲ / ▼** button to select the **TIME** menu.
2. Press the **▶** button and then use **▲ / ▼** button to select **Off time** or **On time**.
3. Press the **▶** button and then use **▲ / ▼** button to select **On**.
To cancel **On/Off time** function, select **Off**.
4. Press the **▶** button and then use **▲ / ▼** button to adjust the hour.
5. Press the **▶** button and then use **▲ / ▼** button to adjust the minute.
6. **Only On time function:** Press the **▶** button and then use **▲ / ▼** button to adjust programme number or volume level.
7. Press the **OK** or **◀** button.
8. Press the **EXIT** button to return to normal TV viewing.

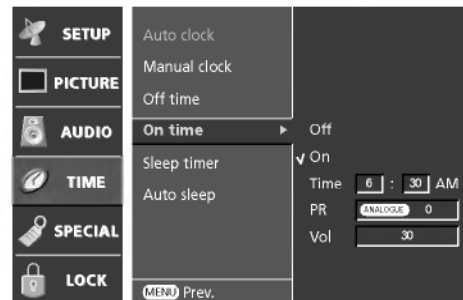

Sleep timer

- You don't have to remember to switch the set off before you go to bed. The sleep timer automatically switches the set to standby after the preset time elapses.

1. Press the **MENU** button and then **▲ / ▼** button to select the **TIME** menu.
2. Press the **▶** button and then **▲ / ▼** button to select **Sleep timer**.
3. Press the **▶** button and then **▲ / ▼** button to select a timer setting on the **Sleep timer** pull-down menu.
4. Press the **OK** or **◀** button.
5. Press the **EXIT** button to return to normal TV viewing.

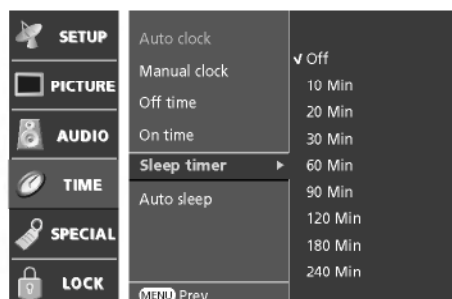

Press the **SLEEP** button to select the number of minutes. The display will appear on the screen, followed by **10**, **20**, **30**, **60**, **90**, **120**, **180** and **240**. The timer begins to count down from the number of minutes selected.

Note :

- a. To view the remaining sleep time, press the **SLEEP** button once.
- b. To cancel the sleep time, repeatedly press the **SLEEP** button until the display  Sleep timer Off appears.
- c. When you switch the set off, the set releases the preset sleep time.

Auto sleep

- If there is no input signal, the set will turn off automatically after 10 minutes.

1. Press the **MENU** button and then **▲ / ▼** button to select the **TIME** menu.
2. Press the **▶** button and then **▲ / ▼** button to select **Auto sleep**.
3. Press the **▶** button and then **▲ / ▼** button to select **On** or **Off**.
4. Press the **OK** or **◀** button.
5. Press the **EXIT** button to return to normal TV viewing.

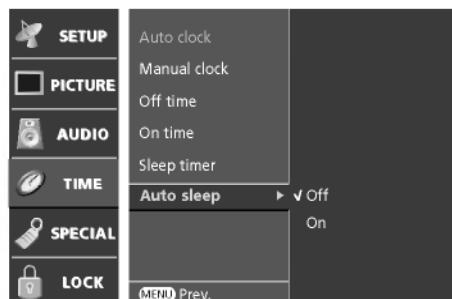

Special Menu Options

Main Picture Source Selection

- Inputs can be set for TV, AV, Component or RGB-PC mode. AV mode is used when a video cassette recorder (VCR), or other equipment is connected to the set.

Note : When a VCR is connected via the aerial socket the set is used in TV mode. See the 'External Equipment Viewing Setups' section.

1. Press the **MENU** button and then use **▲ / ▼** button to select the **SPECIAL** menu.
2. Press the **▶** button and then use **▲ / ▼** button to select **Main input**.
3. Press the **▶** button and then use **▲ / ▼** button to select **Digital, Analogue, AV 1, AV 2, AV 3, Component 1, Component 2, RGB-PC, RGB-DTV, HDMI1/DVI or HDMI2**.

AV 1 : VCR connected to the **AV 1 INPUT** sockets of the set

AV 2 : VCR connected to the **AV 2 INPUT** sockets of the set

AV 3 : VCR connected to the **AV 3 INPUT** sockets of the set

Component1/2 : DVD connected to the **DTV/DVD INPUT** sockets on the back of set

RGB-PC/DTV : PC or SET TOP box connected to the **RGB INPUT** sockets on the back of set

HDMI1/DVI or HDMI2 : PC or SET TOP box connected to the **HDMI1/DVI** or **HDMI2** sockets on the back of set

4. Press the **OK** or **◀** button.
5. Press the **EXIT** button to return to normal TV viewing.

Alternatively you can select the **Digital, Analogue, AV 1, AV 2, AV 3, Component 1, Component 2, RGB-PC** (or **RGB-DTV**), **HDMI1/DVI** or **HDMI2** mode by pressing the **INPUT** button.

In AV, Component, RGB-DTV/PC or HDMI/DVI mode, to return to TV mode, press the **PR ▲ / ▼, Q.VIEW** or **NUMBER** buttons.

Press the **D/A TV** button to select digital or analogue mode.

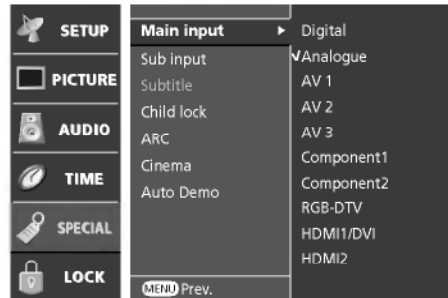

Subtitle (In Digital mode only)

1. Press the **MENU** button and then use **▲ / ▼** button to select the **SPECIAL** menu.
2. Press the **▶** button and then use **▲ / ▼** button to select **Subtitle**.
3. Press the **▶** button and then use **▲ / ▼** button to select **On** or **Off** on the **Subtitle** pull-down menu.
4. Press the **OK** or **◀** button.
5. Press the **EXIT** button to return to normal TV viewing.

You can select Subtitle on or off with the **TEXT** button in DTV mode.

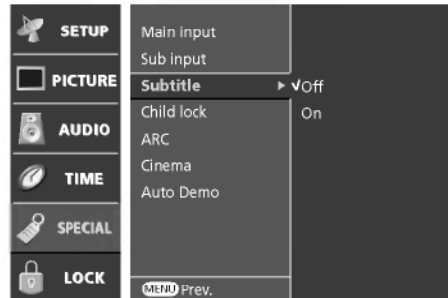

Child Lock

- The TV can be set so that the remote control handset is needed to control it. This feature can be used to prevent unauthorized viewing.

1. Press the **MENU** button and then use **▲ / ▼** button to select the **SPECIAL** menu.
2. Press the **▶** button and then use **▲ / ▼** button to select **Child lock**.
3. Press the **▶** button and then use **▲ / ▼** button to select **On** or **Off**.
4. Press the **OK** or **◀** button.
5. Press the **EXIT** button to return to normal TV viewing.

With the lock on, the display **Child lock On** appears on the screen if any button on the front panel is pressed while viewing the TV.

Note : The display **Child lock On** will not appear on the screen if any button on the front panel is pressed while displaying the menus.

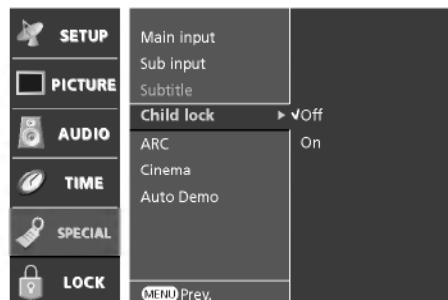

Picture format

- You can watch TV in various picture formats; Auto, 4:3, 16:9 (Wide), 14:9, Zoom and Cinema zoom.
- You can repeatedly press the **ARC** button to select your desired picture format.
- You can also select your desired picture format in the SPECIAL menu.

Note:

- Aspect Ratios available are 4:3 and 16:9 in HDMI/DVI-PC and RGB-PC mode.
- Auto: When your TV receives the wide screen signal, it will be automatically changed to the picture format that is sent. (Not available in all countries)
- You can adjust the enlarge proportion of Cinema Zoom using ▲ / ▼ button. The adjustment range is 1 ~ 16.
- You can adjust the enlarge proportion of Zoom using ▲ / ▼ button. The adjustment range is -16 ~ +16.
- You can adjust the enlarge proportion of 14:9 using ▲ / ▼ button. The adjustment range is -10 ~ +10.

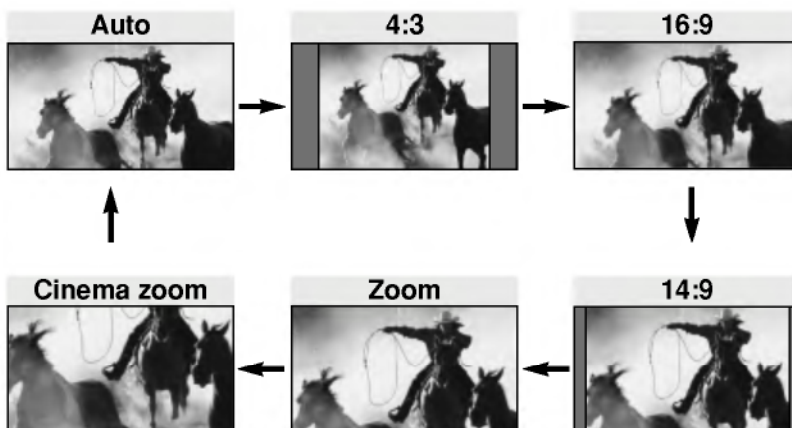

Cinema

- When you watch a movie, this function adjusts the set to the best picture appearance.
 - This function works in AV 60Hz, Component 480i/576i mode.
1. Press the **MENU** button and then use ▲ / ▼ button to select the SPECIAL menu.
 2. Press the ► button and then use ▲ / ▼ button to select **Cinema**.
 3. Press the ► button and then use ▲ / ▼ button to select **On** or **Off**.
 4. Press the **OK** or ◀ button.
 5. Press the **EXIT** button to return to normal TV viewing.

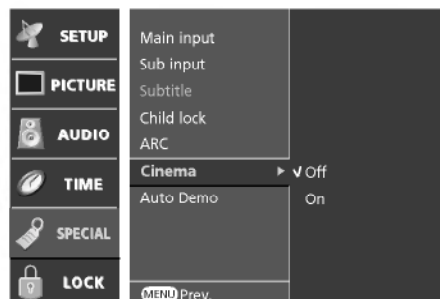

Auto Demo

- Shows you how to navigate the set's on-screen menus.
 - **Auto demo** : Use to scan the features and menu options available on your set.
1. Press the **MENU** button and then use ▲ / ▼ button to select the SPECIAL menu.
 2. Press the ► button and then use ▲ / ▼ button to select **Auto Demo**.
 3. Press the ► or **OK** button to start Auto Demo.
 4. Press the **EXIT** button to stop Auto Demo.

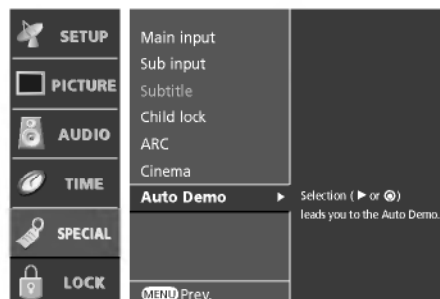

Lock Menu Options

Lock setup

- Lets you set up blocking schemes to block specific channels, ratings, and external viewing sources.
- A password is required to gain access to this menu.

1. Press the **MENU** button and then use **▲** / **▼** button to select the **LOCK** menu.
Then, press the **▶** button to enter the password as requested.
The TV is set up with the initial password "0-0-0-0".
2. Use the **▲** / **▼** button to choose from the following Lock menu options.
Once the option is selected, change the settings to your preference.

Lock system

Activates or disables the blocking scheme you set up previously.

Set password

Change the password by inputting a new password twice.

Block programme

Blocks any programmes that you do not want to watch or that you do not want your children to watch.

Parental guidance (In Digital mode only)

Prevents children from watching certain adult's TV programmes, according to the ratings limit set.

- G (General audience)
- PG (Parental guidance suggested)
- M (Parents strongly cautioned)
- MA (Mature Adult audience only)
- AV (Adult audience)
- R (Restricted)

Aux. block

Enables you to select a source to block from the external source devices you have hooked up.

4. Press the **OK** or **◀** button.
5. Press the **EXIT** button to return to normal TV viewing.

Note : If you forgot your password, press '7', '7', '7', '7' on the remote control handset.

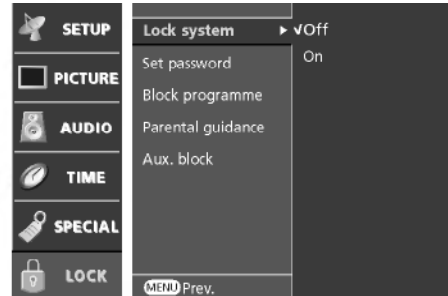

PIP (Picture-In-Picture) / POP / Twin Picture

Option :

PIP (Picture in Picture) displays a picture within a picture.

On and off

- Press the **PIP** button to switch on the sub picture.
- Press **EXIT** button to switch it off.
- Each press of **PIP** button changes the screen display as shown below.

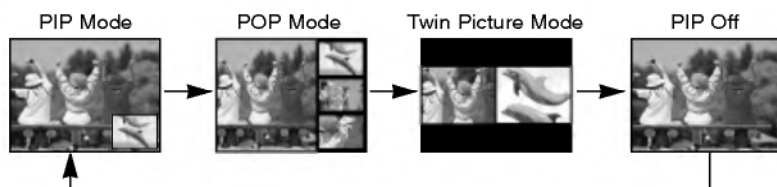

Note :

- When the sub picture size is 1/2 of the main picture, the picture quality might get poor.
- The motion of the sub picture can be unnatural because the set displays full screen by synchronizing the main picture source when the refresh rate between the main picture source and the sub picture source is different in PIP mode.

Input mode selection for sub picture

Press the **PIP INPUT** button to select the input mode for the sub picture.

Each time this button is pressed, each input mode for the sub picture is displayed as shown below.



Main Picture Source	Available Sub Picture Source
Digital	Analogue, AV 1/2/3
Analogue	Digital, AV 1/2/3
AV 1/2/3, Component1/2, RGB, HDMI1/DVI, HDMI2	Digital, Analogue, AV 1/2/3

Note : When the PIP function is switched on, you can also adjust it in the Special menu.

Adjusting main and sub picture sizes for Twin Picture

Use the **▲ / ▼ / ◀ / ▶** button to change main and sub picture sizes in Twin Picture mode.

POP (Picture-out-of-Picture: Channel Scan)

- Use POP to search the programmes of all the memorized channels one-by-one on the 3 PIP screen display, (while the main picture source remains the current channel). The pictures of all the programmed channels are searched with the 3 POP screen.

Sub picture position change

In PIP mode, press the **▲ / ▼ / ◀ / ▶** button to move the sub picture to a different location on the screen.

Programme selection for sub picture

The sub picture programme selection is available when the sub picture is TV mode. Press the **PIP PR +/-** buttons to select a programme for the sub picture.

Swapping between main and sub picture

Press the **SWAP** button to exchange the main and sub picture.

Note : When the main picture is Digital, Analogue or AV modes, the swapping is available.

Teletext (option)

- Teletext (or TOP text) is an optional function, therefore only a set with the teletext system can receive the teletext broadcast.
- Teletext is a free service broadcast by some TV stations which gives up-to-the-minute information on news, weather, television programmes, share prices and many other topics.
- The teletext decoder of this TV can support the SIMPLE, TOP and FASTEXT systems. SIMPLE (standard teletext) consists of a number of pages which are selected by directly entering the corresponding page number. TOP and FASTEXT are more modern methods allowing quick and easy selection of teletext information.

Switch on/off

Press the **TEXT** button to switch to teletext.

- The initial page or last page appears on the screen.
Two page numbers, TV station name, date and time are displayed on the screen headline. The first page number indicates your selection, while the second shows the current page displayed.

Press the **TEXT** button to switch off teletext.

SIMPLE Text (option)

Page selection

1. Enter the desired page number as a three digit number with the **NUMBER** buttons. If during selection you press a wrong number, you must complete the three digit number and then reenter the correct page number.
2. The **PR ▲ / ▼** button can also be used to select the preceding or following page.

TOP text (option)

The user guide displays four fields-red, green, yellow and blue at the bottom of the screen. The yellow field denotes the next group and the blue field indicates the next block.

Block / group / page selection

1. With the blue button you can progress from block to block.
2. Use the yellow button to proceed to the next group with automatic overflow to the next block.
3. With the green button you can proceed to the next existing page with automatic overflow to the next group.
Alternatively the **PR ▲** button can be used.
4. The red button permits to return to previous selection. Alternatively the **PR ▼** button can be used.

Direct page selection

Corresponding to the SIMPLE teletext mode, you can select a page by entering it as a three digit number using the **NUMBER** buttons in TOP mode.

FASTEXT

The teletext pages are colour coded along the bottom of the screen and are selected by pressing the corresponding coloured button.

Page selection

1. Press the  button to select the index page.
2. You can select the pages which are colour coded along the bottom line with the same coloured buttons.
3. Corresponding to the SIMPLE teletext mode, you can select a page by entering its three digit page number with the NUMBER buttons in FASTEXT mode.
4. The PR ▲ / ▼ button can be used to select the preceding or following page.

Special Teletext Functions



REVEAL

Press this button to display concealed information, such as solutions of riddles or puzzles.

Press this button again to remove the information from the display.



SIZE

Selects double height text.

Press this button to enlarge the top half of the page.

Press this button again to enlarge the bottom half of the page.

Press this button again to return to the normal display.



UPDATE

Displays the TV picture on the screen while waiting for the new teletext page.

Press this button to view the updated teletext page.



STILL

Stops the automatic page change which will occur if a teletext page consists of 2 or more sub pages. The number of sub pages and the sub page displayed is, usually, shown on the screen below the time. When this button is pressed the stop symbol is displayed at the top left-hand corner of the screen and the automatic page change is inhibited.

To continue press this button again.



MIX

Displays the teletext pages superimposed on the TV picture.

To switch the TV picture off press this button again.



TIME

This button has two functions:

- a) When viewing a TV programme, press this button to display the time at the top right hand corner of the screen. Press this button again to remove the display.
- b) In teletext mode, press this button to select a sub page number. The sub page number is displayed at the bottom of the screen. To hold or change the sub page, press the RED/ GREEN or PR ▲ / ▼ buttons. Press this button again to exit this function.

EPG (Electronic Programme Guide) (In Digital mode only)

EPG (Electronic Programme Guide) (In Digital mode only)

- This function can be used only when the EPG information is broadcast by broadcasting companies.
- This system has an Electronic Programme Guide (EPG) to help your navigation through all the possible viewing options.
- The EPG supplies information such as programme listings, start and end times for all available services.
- In addition, detailed information about the programme is often available in the EPG (the availability and amount of these programme details will vary, depending on the particular broadcaster).

Switch on/off EPG

1. Press the **GUIDE** button to switch on EPG.
2. Press the **GUIDE** button again to switch off EPG and return to TV viewing.

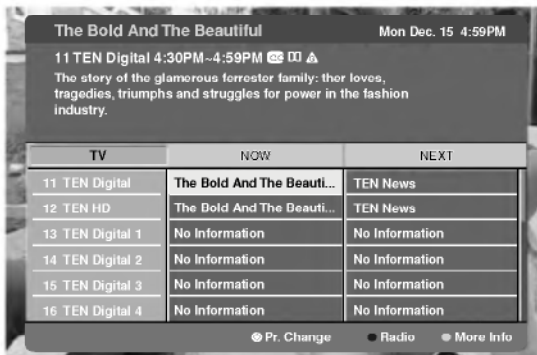

3. Press the **▲ / ▼**, **◀ / ▶** button to select desired programme, then press the **OK** button to display the selected programme.



Colour button operation

RED	shows the TV or Radio programmes
GREEN	the detail information on or off

XSTUDIO

- You can use JPEG and MP3 files by memorizing them to Memory card in **XSTUDIO** mode.

Notes on Memory Card

When removing or handling the memory card, use only your hands. Do not use other devices or the memory card may be damaged.

Memory Card

This is a device equipped to communicate the data between AV external equipment. It's used in a digital camera, camcorder, MP3 player, notebook or PDA.

Precaution for Using the Memory Card

- Please be sure to insert the correct memory card type in the right direction.
(Confirm between the two memory slots before insertion.)
- Don't insert metal substances into the slots of the memory card.
- Do not bend, drop or apply strong shock to memory card.
- After pulling the memory card out from the set, please keep the memory card in an appropriate case to protect it from static shock.
- The stored data may be changed or lost as a result of misuse or static electricity.
- Do not turn the power off while the memory card is in operation.
- Don't eject the memory card while in use. Otherwise, it may cause a data loss or card damage.
- Insert only one card into each slot.
- Static electricity and/or electrical noise has the potential to change or erase the stored data. Please take measures to avoid.
- This Company takes no responsibility for problems such as the damage or malfunction that occurs while using the set, inappropriate settings, or any other reasons, except for defects or malfunctions intrinsic to the product.
- Ensure to use a memory card that lists the manufacturers name and serial number.
- The manufacturer will not be responsible for any data damage. Making back up data is strongly recommended.
- Make sure to comply with the following steps when ejecting a memory card.
- Ensure each memory card has complied with standard.

Notes on Memory Card

Available Memory Card

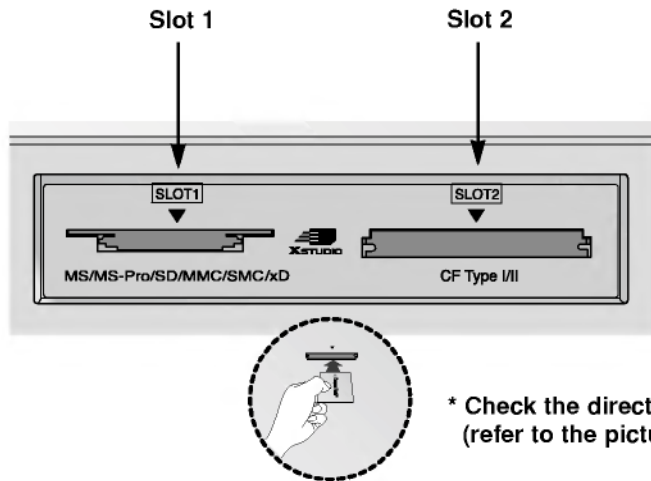

* Check the direction of the Memory card. (refer to the pictures below)

Memory Card type

- Use the specified card based on the slot location.
- 8 types of Memory Card can be used for this set.
- NTFS file system is not supported.

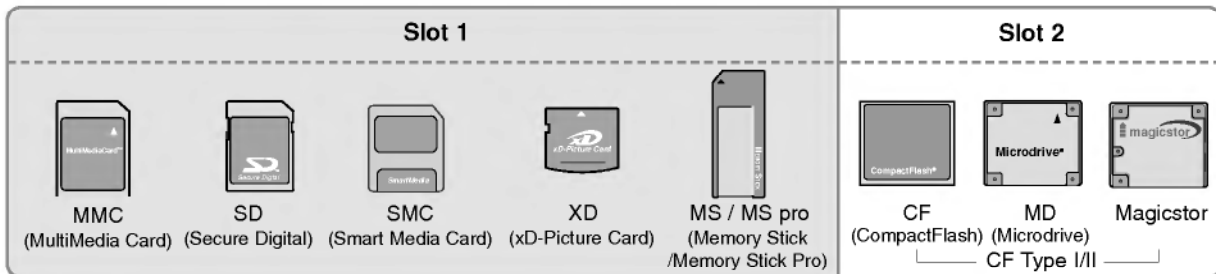





Available file in XSTUDIO mode

A sort of file	Photo Image (JPEG)	Music File (MP3)
Compatibility	*.jpg	*.mp3
Memory card capacity	CF: 2GB Microdrive: 2GB Magicstor: 2.2GB MMC: 256MB SD: 512MB - Some MagicStor Plus cards are not usable. An error may occur if you use a memory card with greater than the specified capacity.	SMC: 128MB XD: 512MB MS: 128MB MS PRO: 1GB
Unsupported or damaged file	Unsupported or damaged JPEG or MP3 files can cause errors. Do not try to change the file extension of unsupported file types to the file extension of supported file types.	

- Playback speed can vary dependent on the card type.
- You can assign 8 characters for the file name of the card. If the file name is longer than 8 characters, it will be truncated at 6 digits and "-1, 2, 3, and 4" will be appended to the 7-8th position.



The JPEG Decoding/The Image Preview Supplied Spec

	Compression Method		Colour format		
	Baseline	Progressive	4:4:4 11:11:11 (Y, Cb, Cr)	4:2:2 21:11:11 (Y, Cb, Cr) 12:11:11 (Y, Cb, Cr)	4:2:0 22:11:11 (Y, Cb, Cr)
JPEG Decoding Support	O	X	X	O	O
Image Display	Image	invalid format	invalid format	Image	Image
Preview Image Display	Display  when there is no thumbnail.			Display  when there is no thumbnail.	Display  when there is no thumbnail.

- If an error occurs when decoding the JPEG, "Corrupted file" is displayed on screen.

How to insert and eject the card

◆ Inserting a Card

1. Insert the card into the Slot 1 and/or Slot 2 with the hand softly and slowly.
2. Press the  button to enter the **XSTUDIO** mode.
Press the  button again to exit the **XSTUDIO** mode.

◆ Ejecting a card

1. Press the **M/C EJECT** button on the remote control.
2. Press **▲ / ▼** button to Select the **Memory 1 Eject** or **Memory 2 Eject** based on the inserted card location.
If selecting **Cancel**, OSD will disappear.
3. Carefully remove the card.

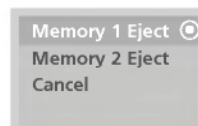

Notes:

- Screen saver will appear if you do not remove the card with the hand after operating the eject function.
- When entering the photo or music media at first, the **M/C EJECT** button will not work.
It's possible to use the **M/C EJECT** button while using the photo or music media.



Caution: Press the **M/C EJECT** button on remote control before removing the memory card.
Failure to do so may damage the card.



Notes on Memory Card

* In this manual, the OSD (On Screen Display) may be different from your set's because it is just an example to help you with the set operation.

Select the Photo or Music Media

- When you plug a memory card or press the  button, the below screens will be displayed.



1. Press  button to select photo or music for slot1/2.
2. Press the **OK** button to enter the photo or music media.
3. Press the  button to exit the **XSTUDIO** mode.

Notes:

- The OSD of the ejected card slot is inactivate when ejecting the card.
- If there is any error in a memory card, it's impossible to enter **XSTUDIO** mode.

JPEG File Viewing Options

- When you select **Photo** in entry menu, you will now see a screen filled with thumbnail photo media.

* In this manual, the OSD (On Screen Display) may be different from your set's because it is just an example to help you with the set operation.

Screen Components

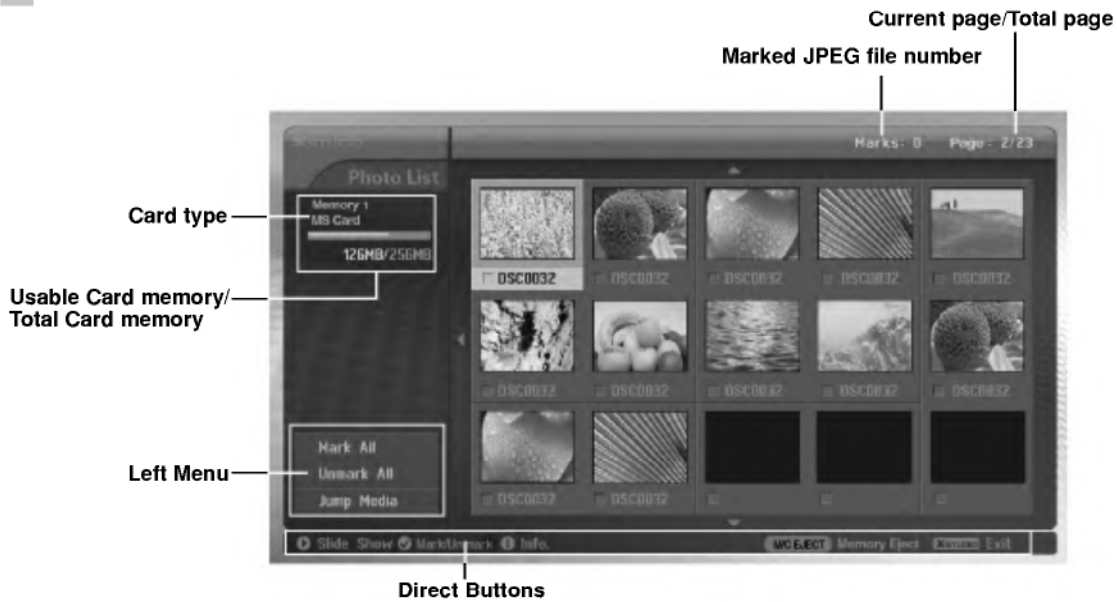

Photo Selection and PopUp menu

- Select your desired image file.



1. Insert the memory card to Slot 1 and/or Slot 2 on the set side panel.
2. Press the **Xtudio** button.
3. Use **▲ / ▼ / ◀ / ▶** button to select photo media for slot1 or slot 2.
4. Press the **OK** button to enter the photo media.
Note: It's possible to display 15 JPEG files per page.
5. Press the **▲ / ▼ / ◀ / ▶** button to select JPEG file and then press the **OK** button.
6. Press the **▲ / ▼** button to select **View** and then press the **OK** button. The selected image will display over the entire screen.

JPEG File Viewing Options

Mark/Unmark for JPEG file

- You can mark/unmark the file to view the desired file or use slide show for desired file conveniently.
 - The selected file displays orange in colour.
- When pressing the **OK** button after marking a file, the marked file displays green in colour.



◆ Mark/Unmark for all files

1. In photo media, repeatedly press ◀ button to enter the menu on the left.
2. Press the ▲ / ▼ button to select **Mark All** or **Unmark All**.
 - If you select **Mark All**, every file is selected.
 - If you select **Unmark All**, the selection for every file is released.
3. Press the **OK** button and then ▶ button to return to the photo list.

◆ Mark/Unmark for some file

Press the **MARK** button repeatedly to mark or unmark some JPEG file.

Jump Media

- Use this function to jump to other media during using photo media.

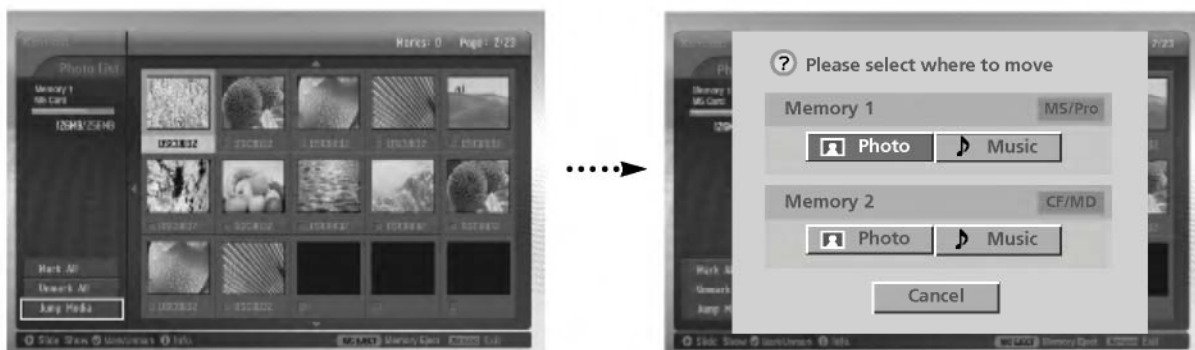

1. In photo media, press ◀ button repeatedly to enter the left menu.
2. Press the ▲ / ▼ button to select **Jump media** and then press the **OK** button.
3. Press the ▲ / ▼ / ◀ / ▶ button to select desired media and then press the **OK** button. The screen displays each media list.

The Image Adjustment

- You can display the selected image on the entire screen and do the various adjustments for the JPEG file.



1. Press the ▲ / ▼ / ◀ / ▶ button to select JPEG file and then press the OK button.
2. Press the ▲ / ▼ button to select **View** and then press the OK button The selected image will display on entire screen.
3. Adjust the JPEG file.



Image selection	<ul style="list-style-type: none"> • Press the ▶ button to select next image. • Press the ◀ button to select previous image. • If you mark a file, you can see only the marked image.
Image Rotation	<ul style="list-style-type: none"> • Press the ▲ / ▼ button to rotate the image. • ▲: Rotate clockwise • ▼: Rotate counterclockwise • The enlarged image cannot be rotated.
Image Zoom In/Out	<ul style="list-style-type: none"> • Press the PR ▲ / ▼ button to enlarge or reduce the image 2 or 4 times. • Press the ▲ / ▼ / ◀ / ▶ button to move the enlarged image.
Image Deletion	<ul style="list-style-type: none"> • Press the MARK button to delete the current image.
Go to the Menu	<ul style="list-style-type: none"> • Press the EXIT button to return to the photo list.
Show/Hide the menu	<ul style="list-style-type: none"> • Each press of the OK button, the menu will toggle hidden or shown. • The OSD menu will automatically disappear after a while.

JPEG File Viewing Options

Slide Show



1. Press the ▲ / ▼ / ◀ / ▶ button to select JPEG file and then press the OK button.
2. Press the ▲ / ▼ button to select **Slide Show** or **Show Marked** and then press the OK button. (If you mark the file using the MARK button, **Show Marked** is displayed on screen.)



3. You can choose the slide show delayed time and effect. Press the ▲ / ▼ / ◀ / ▶ button to choose the slide show delayed time and effect.
4. Press the ▲ / ▼ / ◀ / ▶ button to select **OK**. Slide show start.

Notes:

- You can also operate the **Slide Show** or **Show Marked** with  button directly as shown.
- If you mark a file, Slide Show will show only the marked image.



Next / previous Image Selection	<ul style="list-style-type: none"> • Press the ▶ button to select next image. • Press the ◀ button to select previous image.
Image Pause	<ul style="list-style-type: none"> • Press the button to pause the current image. • Press the  button to restart the slide show. • By pressing ◀ / ▶ button, you can also select the next or previous image while pausing the image.
Go to the menu	<ul style="list-style-type: none"> • Press the EXIT button to return to the photo list.
Show/Hide the menu	<ul style="list-style-type: none"> • Each press of the OK button, the menu is toggled hidden or shown. • The OSD menu will automatically disappear after a while.

JPEG file Deletion and Cancel



1. Use the ▲ / ▼ / ◀ / ▶ button to select JPEG file and then press the **OK** button.
2. To delete the file, press the ▲ / ▼ button to select **Delete** and then press the **OK** button. When "Do you want to delete the file?" message is displayed, select **YES (YES or NO)** with ◀ / ▶ button. The file is deleted, all the following files are shifted up one position.

* If you select **Delete** after marking some files, all of the marked files are deleted. But in case MS,SMC,SD memory card is set to write protect, " Protection Mode. Please push the **OK** button." message is displayed. When you select the **OK**, the screen will return to the photo list.(Release the write protection to delete a JPEG file.)

3. To return to the photo list, press the ▲ / ▼ button to select **Cancel** and then press the **OK** button.

File Information

- Use it to check information for selected JPEG file.



1. In photo media, select your desired JPEG file.
2. Press the **INFO** button. The file information for selected JPEG file is displayed. If JPEG file has no information, you can't check it.
3. Press the **OK**, **EXIT** or **INFO** button to return to the photo list.

Screen Saver

- While displaying the photo list, if a button is not pressed within approx. 30 seconds, the screen saver is activated.

* The 'Screen Saver'?
Screen saver is to prevent screen pixel burning caused by long time still picture.



- Press the ▲ / ▼ / ◀ / ▶, **EXIT**, ▶(play), II, ■, I◀◀, ▶▶I, **INFO**, PR ▲ / ▼, **MARK** buttons to release the screen saver.

MP3 File Playing Operation

- Purchased MP3/music files may contain copyright restrictions. Playback of these files may not be supported by this model.

Screen Components

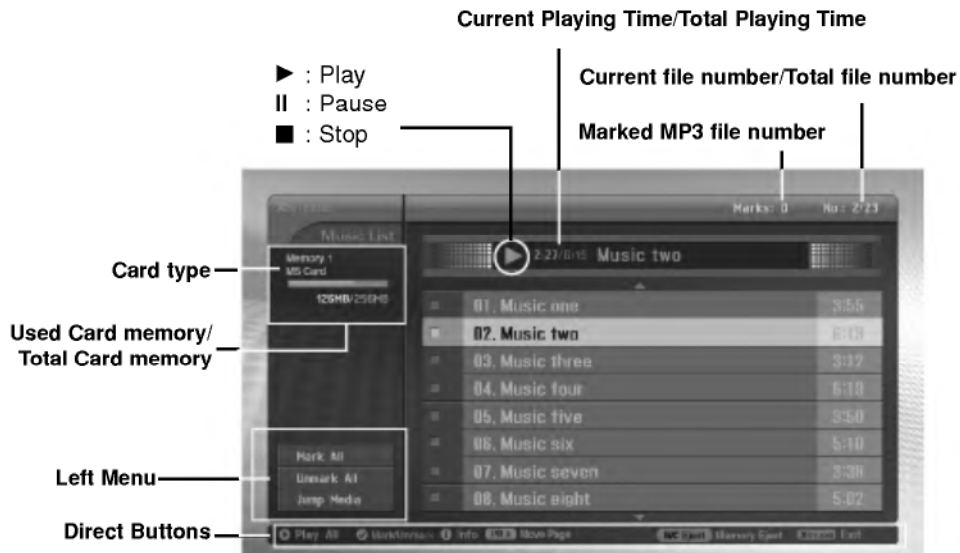

MP3 File Selection and Playback

- MP3 file Selection and deletion function won't work while playing music.
- If pressing any button except , , button on the remote control while playing music, the music playing is stopped.
- Move from the current 8 files list to the next files list with **PR ▲ / ▼** button.



1. Insert the memory card into Slot 1 and/or Slot 2 located on front of unit.
2. Press the **SETUP** button.
3. Use **▲ / ▼ / ◀ / ▶** button to select music media for Slot1 or Slot 2.
4. Press the **OK** button to enter the music media.
Note: It's possible to display 8 MP3 files per page.
5. Press the **▲ / ▼** button to select desired MP3 file and then press the **OK** button.
6. Press the **▲ / ▼** button to select **Play** or **Play Marked** and then press the **OK** button. (If you mark the file with using **MARK** button, **Play Marked** is displayed on screen.)

Notes:

- You can also play the music with button directly.
- The current playing MP3 file displays in front of the title.
- While playing music, press the **▶▶** button to select the next music directly.
- If you press the **◀◀** button while playing music, the MP3 will replay from beginning. (If you press the **◀◀** button within 1~2 seconds after playing the music, the MP3 plays the previous file.)

* In this manual, the OSD (On Screen Display) may be different from your set's because it is just an example to help you with the set operation.

Stop/Pause Playback

◆ Stop Playback

To stop playback, press the **■** button on the remote control.

To stop playback, press the **OK, PR (▲ / ▼)** button on the set.

Notes:

- If you replay the MP3 file after stopping, the highlighted MP3 file on menu will play.
- On stopping, **VOL (◀ / ▶)** and **PR (▲ / ▼)** buttons on the set are used to navigate.

◆ Pause Playback

1. Press the **II** button to pause playback.

2. Press the **II** or **▶** button to starts from the point of your paused part.

Mark/Unmark for MP3 file

- You can mark/unmark the file to play the desired file only.
- The menu on the left can be used when playback is stopped.



◆ Mark/Unmark for all files

1. In music media, press the **◀** button.
2. Press the **▲ / ▼** button to select **Mark All** or **Unmark All**.
 - If you select **Mark All**, every file is selected.
 - If you select **Unmark All**, the selection for every file is released.
3. Press the **OK** button and then **▶** button to return to the music list.

◆ Mark/Unmark for some file

Press the **MARK** button repeatedly to mark or unmark some MP3 file.

MP3 File Playing Operation

Jump Media

- Use this function to jump to other media whilst using music media.

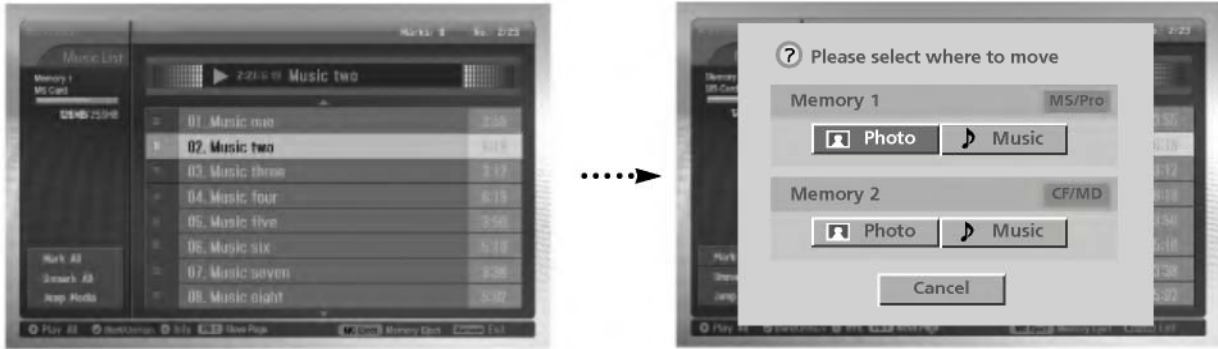

1. In music media, press the ◀ button.
2. Press the ▲ / ▼ button to select **Jump media** and then press the OK button.
3. Press the ▲ / ▼ / ◀ / ▶ button to select desired media and then press the OK button. The screen displays each media list.

Screen Saver

- If you don't press any button for about 30 seconds, the screen saver is activated.

◆ During playing the MP3

* The 'Screen Saver'?
Screen saver is to prevent screen pixel burning caused by long time still picture.

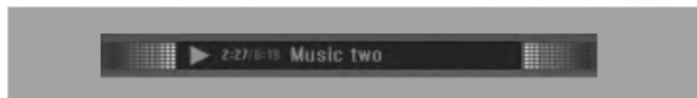

- Press the ▶, ◀, and ⏮ buttons. The screen saver is released but the MP3 playback is restarted.
- ◀, ⏮ : Return to a initial portion of the MP3 playback.
- ⏭ : Playback the next MP3.
- If you press any other button, the screen saver is released and the MP3 playback is stopped.

◆ Whilst MP3 is stopped.



- Press the ▲ / ▼ / ◀ / ▶, EXIT, ▶(play), II, ■, ◀◀, ▶▶, INFO, PR ▲ / ▼, MARK buttons to release the screen saver.

MP3 file deletion and Cancel

- It's impossible to delete the music during playback.



1. Use the ▲ / ▼ button to select MP3 file and then press the **OK** button.
2. To delete the file, press the ▲ / ▼ button to select **Delete** and then press the **OK** button. When “Do you want to delete the file?” message is displayed, select **YES** (**YES** or **NO**) with ◀ / ▶ button. The file is deleted, all the following files are shifted up one position.

* If you select **Delete** after marking some files, all of the marked files are deleted. But in case MS, SMC, SD memory card setted the write protection, “ Protection Mode. Please push the **OK** button.” message is displayed. When you select the **OK**, the screen is returned to the photo list.(Release the write protection to delete a MP3 file.)

3. To return to the music list, press the ▲ / ▼ button to select **Cancel** and then press the **OK** button.

File Information

- Use it to check information for selected MP3 file.



1. In music media, select your desired MP3 file.
2. Press the **INFO** button. The file information for selected MP3 file is displayed. If MP3 file has no information, you can't check it.
3. Press the **OK**, **EXIT** or **INFO** button to return the previous menu.

Programming the Remote

- The remote is a multi-brand or a universal remote. It can be programmed to operate most remote-controllable devices of other manufacturers.

Note that the remote may not control all models of other brands.

Programming a code into a remote mode

- To find out whether your remote can operate the device without programming, turn on the device such as a VCR and press the corresponding mode button on the remote.
After that, press the **POWER** button. If the device has turned off then it responds properly and the remote need not to be programmed. If not, the remote should be programmed to operate the device. The programming procedures are explained below.
- Press the **MENU** and **MUTE** button continuously at the same time for 2 seconds, the current selected device button will be illuminated.
If you don't press any button for 20 seconds, the light on the mode button will be turned off. In that case, you have to repeat from step 2.
- Enter code numbers using the number button on the remote by referring to the code table on the following pages. When pressing the button, the light blinks. If the device turned off, the programming is successful.
- Press the **MENU** button to store the code. After blinking twice, this code is stored.
- Test the remote functions to see if the device responds properly. If not, repeat from step 2.

Programming Codes

VCRs

Brand	Codes	Brand	Codes	Brand	Codes	Brand	Codes
AIWA	034	KENWOOD	014 034 039 043	PORTLAND	108	TATUNG	039 043
AKAI	016 043 046 124		047 048	PULSAR	072	TEAC	034 039 043
	125 146	LG (GOLDSTAR)	001 012 013 020	QUARTZ	011 014	TECHNICS	031 033 070
AMPRO	072		101 106 114 123	QUASAR	033 066 075 145	TEKNIKA	019 031 033 034
ANAM	031 033 103	LLOYD	034	RCA	013 020 033 034		101
AUDIO DYNAMICS	012 023 039 043	LXI	003 009 013 014		040 041 062 063	THOMAS	034
BROKSONIC	035 037 129	MAGIN	017 034 101 106		107 109 140 144	TMK	006
CANON	028 031 033	MAGNAVOX	040	REALISTIC	145 147	TOSHIBA	008 013 042 047
CAPEHART	108		031 033 034 041		003 008 010 014		059 082 112 131
CRAIG	003 040 135		067 068		031 033 034 040	TOTEVISION	040 101
CURTIS MATHES	031 033 041	MARANTZ	012 031 033 067		053 054 101	UNITECH	040
DAEWOO	005 007 010 064		069	RICO	058	VECTOR RESEARCH	012
	065 108 110 111	MARTA	101	RUNCO	148	VICTOR	048
	112 116 117 119	MATSUI	027 030	SALORA	014	VIDEO CONCEPTS	012 034 046
DAYTRON	108	MEI	031 033	SAMSUNG	032 040 102 104	VIDEOSONIC	040
DBX	012 023 039 043	MEMOREX	003 010 014 031		105 107 109 112	WARDS	003 013 017 024
DYNATECH	034 053		033 034 053 072		113 115 120 122		031 033 034 040
ELECTROHOME	059		101 102 134 139		125		053 054 131
EMERSON	006 017 025 027	MGA	045 046 059	SANSUI	022 043 048 135	YAMAHA	012 034 039 043
	029 031 034 035	MINOLTA	013 020	SANYO	003 007 010 014	ZENITH	034 048 056
	036 037 046 101	MITSUBISHI	013 020 045 046		102 134		058 072 080 101
	129 131 138 153		049 051 059 061	SCOTT	017 037 112 129		
FISHER	003 008 009 010		151		131		
FUNAI	034	MTC	034 040	SEARS	003 008 009 010		
GE	031 033 063 072	MULTITECH	024 034		013 014 017 020		
	107 109 144 147	NEC	012 023 039 043		031 042 073 081		
GO VIDEO	132 136		048		101		
HARMAN KARDON	012 045	NORDMENDE	043	SHARP	031 054 149		
HITACHI	004 018 026 034	OPTONICA	053 054	SHINTOM	024		
	043 063 137 150	PANASONIC	066 070 074 083	SONY	003 009 031 052		
INSTANTREPLAY	031 033		133 140 145		056 057 058 076		
JCL	031 033	PENTAX	013 020 031 033		077 078 149		
JCPENNY	012 013 015 033		063	SOUNDESIGN	034		
	040 066 101	PHILCO	031 034 067	STS	013		
JENSEN	043	PHILIPS	031 033 034 054	SYLVANIA	031 033 034 059		
JVC	012 031 033 043		067 071 101		067		
	048 050 055 060	PILOT	101	SYMPHONIC	034		
	130 150 152	PIONEER	013 021 048	TANDY	010 034		

DVD

Brand	Codes	Brand	Codes	Brand	Codes	Brand	Codes
APEX DIGITAL	022	MAGNAVOX	013	PHILIPS	013	SONY	007
DENON	020 014	MARANTZ	024	PIONEER	004 026	THOMPSON	005 006
GE	005 006	MITSUBISHI	002	PROCEED	021	TOSHIBA	019 008
HARMAN KARDON	027	NAD	023	PROSCAN	005 006	YAMAHA	009 018
JVC	012	ONKYO	008 017	RCA	005 006	ZENITH	010 016 025
LG	001 010 016 025	PANASONIC	003 009	SAMSUNG	011 015		

Replacing the Lamp

Lamp unit replacement

* You must replace the lamp when:

The image gets darker or starts to deteriorate.
The lamp indicator is orange.
The lamp indicator is red.
The message "Lamp Life Over" appears on the screen when turning the TV on.

<Front panel of the TV>

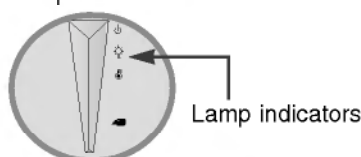

Be careful when replacing lamp

- Turn off the power with the remote control.
In 3 minutes, press the power button to off on the front panel and unplug the power cord. (For 2 minutes, cooling fan works after turning off power)
- Allow the lamp to cool for 30 minutes before replacing it.
- Replace only with the same type lamp from an LG Electronics Service Centre. Using another lamp type may cause damage to the TV and lamp.
- Pull out the lamp only when replacing the lamp.
- Keep the lamp unit out of reach of children and heat sources such as radiators, stoves.
- To reduce the risk of fire, lamp shall not be exposed to liquids or foreign material.
- Do not place the lamp near any heat source.
- Make sure the new lamp is securely tightened with screws.
If not, the image may be dark or there could be a risk of fire.
- Never touch the lamp unit glass or otherwise it will become dirty.

To obtain a replacement Lamp unit

Lamp model number is on the lamp cover. Check the lamp model and then locate an LG Electronics service center.
Using another type of lamp may cause damage to the TV or lamp.

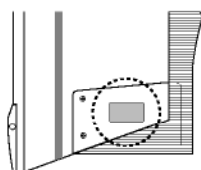

Lamp unit disposal

LG Electronics is provided with an interlock switch to reduce the risk of excessive ultraviolet radiation.
Dispose of the used lamp by returning it to the LG Electronics service center.

Replacing the Lamp

1. Turn off the power on the remote control to ST-BY.
In 3 minutes, press the power button to off on the front panel

and unplug the power cord.
(Allow the lamp to cool for 30 minutes before replacing it.)



lamp case Screws

2. Remove the 2 retaining screws on the lamp cover with a "+" type screwdriver then separate the lamp cover from the TV.
3. Remove the two retaining screws on the lamp case by using "+" type screwdriver.
4. Lift up the fixed wire handle on the lamp.
5. Pull out the knob slowly and remove the lamp case.
6. Insert the new lamp gently into the correct position. Make sure it is inserted correctly.
7. Tighten the screws you removed in step 3.



Screws

8. Replace the lamp cover and tighten the cover screws.
(If the lamp cover is open, the lamp indicator flashes green and the TV will not turn on.)



Knob

Note :

- Only use LG approved lamp replacement.
- Using incorrect type of lamp may cause damage to the TV or lamp.
- Make sure the lamp cover is securely fastened. If the lamp cover is open, the TV will not turn on.

Reset Lamp Use Time

- * You must reset lamp time on the menu after replacing the lamp.
- * In some models, the lamp time may not be reset.

1. Press the **OK** or **ENTER** button on the front panel and **MUTE** button on the remote control simultaneously (For Approx. 5 seconds).

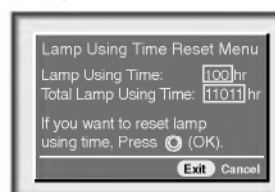

2. Press the **OK** or **▶** button.
Lamp use time will be reset.

Troubleshooting Checklist

No picture & No sound	<ul style="list-style-type: none">• Check whether the set is turned on.• Power cord inserted into wall outlet?• Plug another product's power cord into the wall outlet where the set's power cord was plugged in. To confirm wall outlet is operational.
Picture OK & No sound	<ul style="list-style-type: none">• Press the VOL (▲) button.• Sound muted? Press MUTE button. <p>Check whether the TV speaker is "on" in the SOUND menu. (Refer to p. 21)</p>
The remote control doesn't work	<ul style="list-style-type: none">• Check to see if there is any object between the set and the remote control causing obstruction.• Check to see if the batteries are installed with the correct polarities. (Refer to p.4)• Check if the remote control handset is set up to correct mode.• Install new batteries. (Refer to p.4)
Picture appears slowly, after switching on	<ul style="list-style-type: none">• This is normal as the image is muted during the startup process of the set. Please contact your service centre, if the picture has not appeared after five minutes.
No or Poor colour or Poor picture	<ul style="list-style-type: none">• Select Colour in the PICTURE menu and press the ► button. (Refer to p.18)• Keep a certain distance between the set and the VCR.• Activate any function to restore the brightness of the picture.
Horizontal/vertical bars or picture shaking	<ul style="list-style-type: none">• Check for local interference such as an electrical appliance or power tool.
No output from one of the speakers	<ul style="list-style-type: none">• Adjust Balance in the SOUND menu. (Refer to p.20)
Unusual sound from inside the set	<ul style="list-style-type: none">• A change in ambient humidity or temperature may result in an unusual noise at the time of switching off or on of the set and does not indicate a fault with the set.

Maintenance

- Early malfunctions can be prevented. Careful and regular cleaning can extend the amount of time you will have your new TV. Be sure to turn the power off and unplug the power cord before you begin any cleaning.

Cleaning the Screen

1. Here's a great way to keep the dust off your screen for a while. Wet a soft cloth in a mixture of lukewarm water and a little fabric softener or dish washing detergent. Wring the cloth until it's almost dry, and then use it to wipe the screen.
2. Make sure the excess water is off the screen, and then let it air-dry before you turn on your TV.

Cleaning the Cabinet

To remove dirt or dust, wipe the cabinet with a soft, dry, lint-free cloth. Please be sure not to use a wet cloth.

Extended Absence



If you expect to leave your TV dormant for a long time (such as a vacation), it's a good idea to unplug the power cord to protect against possible damage from lightning or power surges.

Product Specifications

MODEL	71SA1D-AA
Width (inches / mm)	72.2 / 1833
Height (inches / mm)	45.5 / 1155
Depth (inches / mm)	22.2 / 564
Weight (pounds / kg)	141.1 / 64
Power requirement	AC240V~ 50Hz
Operating Temperature Range	32 ~ 104°F (0 ~ 40°C)
Operating Humidity Range	Less than 80%

- The specifications shown above may be changed without notice for quality improvement.

