

# TOSHIBA

## TDP-P9

### DATA PROJECTOR

---

## *OWNER'S MANUAL*

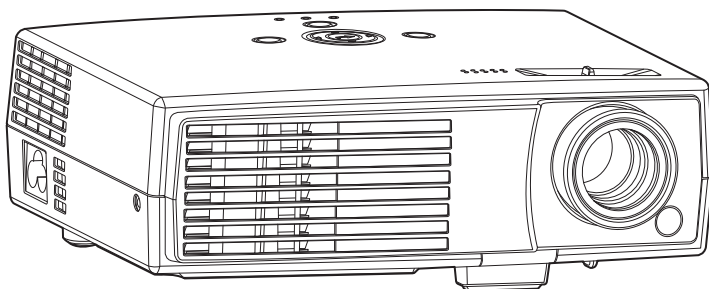

Before Using

Preparations

Operations

Maintenance

Others

# SAFETY PRECAUTIONS



The lightning flash with arrowhead symbol, within an equilateral triangle, is intended to alert the user to the presence of uninsulated "dangerous voltage" within the product's enclosure that may be of sufficient magnitude to constitute a risk of electric shock to persons.



The exclamation point within an equilateral triangle is intended to alert the user to the presence of important operating and maintenance (servicing) instructions in the literature accompanying the appliance.

**WARNING:** TO REDUCE THE RISK OF FIRE OR ELECTRIC SHOCK, DO NOT EXPOSE THIS APPLIANCE TO RAIN OR MOISTURE. DANGEROUS HIGH VOLTAGES ARE PRESENT INSIDE THE ENCLOSURE. DO NOT OPEN THE CABINET. REFER SERVICING TO QUALIFIED PERSONNEL ONLY.

**WARNING:** Handling the cord on this product or cords associated with accessories sold with this product, will expose you to lead, a chemical known to the State of California to cause birth defects or other reproductive harm. ***Wash hands after handling.***

**WARNING:** Lamp contains mercury. Disposal of this product may be regulated due to environmental considerations. For disposal, reuse or recycling information, please contact your local government or the Electronic Industries Alliance at [www.eiae.org](http://www.eiae.org).

**MODEL NAME: TDP-P9** USA ONLY

<p>TRADE NAME: DATA PROJECTOR</p> <p><b>FC</b> Tested To Comply With FCC Standards</p> <p>FOR HOME OR OFFICE USE</p>	<p>MODEL NAME: TDP-P9</p>
--	---------------------------

**FCC NOTICE:** This device complies with part 15 of the FCC Rules. Operation is subject to the following two conditions:

(1) This device may not cause harmful interference, and (2) this device must accept any interference received, including interference that may cause undesired operation.

This equipment has been tested and found to comply with the limits for a Class B digital device, pursuant to part 15 of the FCC Rules. These limits are designed to provide reasonable protection against harmful interference in a residential installation. This equipment generates, uses and can radiate radio frequency energy and, if not installed and used in accordance with the instructions, may cause harmful interference to radio communications.

However, there is no guarantee that interference will not occur in a particular installation. If this equipment does cause harmful interference to radio or television reception, which can be determined by turning the equipment off and on, the user is encouraged to try to correct the interference by one or more of the following measures:

- Reorient or relocate the receiving antenna.
- Increase the separation between the equipment and receiver.
- Connect the equipment into an outlet on a circuit different from that to which the receiver is connected.
- Consult the dealer or an experienced radio/TV technician for help.

RESPONSIBLE PARTY: TOSHIBA AMERICA INFORMATION SYSTEMS, INC.  
9740 Irvine Blvd., Irvine, CA 92618-1697 U.S.A  
Phone: (949) 583-3000

**WARNING:** Changes or modifications made to this equipment, not expressly approved by **USA ONLY** Toshiba, or parties authorized by Toshiba, could void the user's authority to operate the equipment.

**Notice:** This Class B digital apparatus complies with Canadian ICES-003. Cet appareil numérique de la classe B est conforme à la norme NMB-003 du Canada. **CANADA ONLY**

# IMPORTANT SAFETY INSTRUCTIONS

**CAUTION: PLEASE READ AND OBSERVE ALL WARNINGS AND INSTRUCTIONS GIVEN IN THIS OWNER'S MANUAL AND THOSE MARKED ON THE UNIT. RETAIN THIS BOOKLET FOR FUTURE REFERENCE.**

This unit is fully transistorized and does not contain any parts that can be repaired by the user.

**DO NOT REMOVE THE CABINET COVER, OR YOU MAY BE EXPOSED TO DANGEROUS VOLTAGE. REFER SERVICING TO QUALIFIED SERVICE PERSONNEL ONLY.**

## 1. Read Owner's Manual

After unpacking this product, read the owner's manual carefully, and follow all the operating and other instructions.

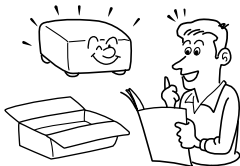

## 3. Source of Light

Do not look into the lens while the lamp is on. The strong light from the lamp may cause damage to your eyesight.

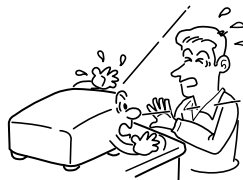

## 2. Power Sources

This product should be operated only from the type of power source which does not exceed the voltage range specified on the rating label and the power cord. If you are not sure of the type of power supply to your home, consult your product dealer or local power company.



## 4. Ventilation

Openings in the cabinet are provided for ventilation and to ensure reliable operation of the product and to protect it from overheating, and these openings must not be blocked or covered. The openings should never be blocked by placing the product on a bed, sofa, rug or other similar surface. This product should not be placed in a built-in installation such as a bookcase or rack unless proper ventilation is provided.



## 5. Heat

The product should be situated away from heat sources such as radiators, heat registers, stoves, or other products (including amplifiers) that produce heat.

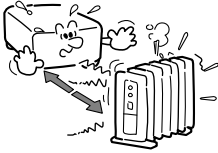

## 6. Water and Moisture

Do not use this product near water.

- for example, near a bath tub, wash bowl, kitchen sink, or laundry tub; in a wet basement; or near a swimming pool and the like.

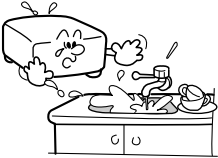

## 7. Cleaning

Unplug this product from the wall outlet before cleaning. Do not use liquid cleaners or aerosol cleaners. Use a soft cloth for cleaning.

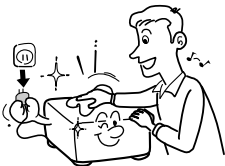

## 8. Be sure that you firmly insert the plug into the wall outlet.

Incorrect or faulty connections may result in fire or electric shock. Avoid using an unsound or loose outlet.

## 9. Power-Cord Protection

Power-supply cords should be routed so that they are not likely to be walked on or pinched by items placed upon or against them, paying particular attention to cords at plugs, convenience receptacles, and the point where they exit from the product.



## 10. Overloading

Do not overload wall outlets; to reduce the risk of electric shock, do not use the polarized plug with an extension cord, receptacle, or other outlet unless the blades can be inserted completely with three-wire grounding type to prevent blade exposure. As this can result in a risk of fire or electric shock.



# IMPORTANT SAFETY INSTRUCTIONS (Continued)

## 11. Lightning storms

For added protection for this product during storm, or when it is left unattended and unused for long periods of time, unplug it from the wall outlet. This will prevent damage to the product due to lightning and power-line surges.

However, while it is thundering or lightning, do not touch the apparatus and any connected cable and/or equipment.

This will prevent you from receiving the electric shock by an electric surge.

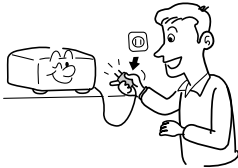

## 12. Object and Liquid Entry

Never push objects of any kind into this product through openings as they may touch dangerous voltage points or short-out parts that could result in a fire or electric shock. Never spill liquid of any kind on the product.



## 13. Do not place or keep the projector within the reach of the children.

It may fall down or tip over, which could result in severe injury.

## 14. Do not place the product vertically

Do not use the product in the upright position to project the pictures, or any other vertical positions. It may fall down and dangerous.

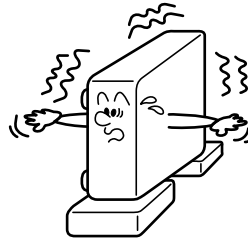

## 15. Stack Inhibited

Do not stack other equipment on this product or do not place this product on the other equipment. Top and bottom plates of this product develops heat and may give some undesirable damage to other unit.

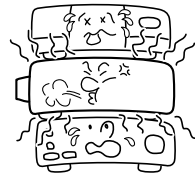

## 16. Attachments

Do not use attachments not recommended by the product manufacturer as they may cause hazards.

## 17. Accessories

Do not place this product on an unstable cart, stand, tripod, bracket, or table. The product may fall, causing serious injury to a child or adult, and serious damage to the product. A product and cart combination should be moved with care. Quick stops, excessive force, and uneven surfaces may cause the product and cart combination to overturn.



S3125A

## 18. Damage Requiring Service

Unplug this product from the wall outlet and refer servicing to qualified service personnel under the following conditions:

- a) When the power-supply cord or plug is damaged.
- b) If liquid has been spilled, or objects have fallen into the product.
- c) If the product has been exposed to rain or water.
- d) If the product does not operate normally by following the operating instructions. Adjust only those controls that are covered by the operating instructions as an improper adjustment of other controls may result in damage and will often require extensive work by a qualified technician to restore the product to its normal operation.

- e) If the product has been dropped or damaged in any way (If the cabinet should break, please handle with care to avoid injury) .
- f) When the product exhibits a distinct change in performance - this indicates a need for service.

## 19. If glass components, including lens and lamp, should break, contact your dealer for repair service.

This product incorporates glass components, including a lens and a lamp. If such parts should break, please handle with care to avoid injury and contact your dealer for repair service. The broken pieces of glass may cause injury. In the unlikely event of the lamp rupturing, thoroughly clean the area around the projector and discard any edible items placed in that area.

## 20. Servicing

Do not attempt to service this product yourself as opening or removing covers may expose you to dangerous voltage or other hazards. Refer all servicing to qualified service personnel.



## IMPORTANT SAFETY INSTRUCTIONS (Continued)

---

### 21.Replacement Parts

When replacement parts are required, be sure the service technician has used replacement parts specified by the manufacturer or have the same characteristics as the original part. Unauthorized substitutions may result in fire, electric shock, or other hazards. (Replacement of the lamp only should be made by users.)

### 22.Safety Check

Upon completion of any service or repairs to this product, ask the service technician to perform safety checks to determine that the product is in proper operating condition.



### 23.Do not leave thermal-paper documents or easily deformed items on top of the unit or near the air exhaust for long periods of time.

The heat from the unit could erase the information on the thermal paper, or cause deformation or warping.

### 24.Do not use the product in a closed installation state.

Do not place the product in a box or in any other closed installation state. Otherwise it may overheat. This could result in a risk of fire.

### 25.Do not look into the laser light source of the remote control or direct the laser pointer toward a person or a mirror.

The laser beam may cause damage to your eyesight.



# IMPORTANT PRECAUTIONS

## Moisture Condensation

Never operate this unit immediately after moving it from a cold location to a warm location. When the unit is exposed to such a change in temperature, moisture may condense on the lens and the crucial internal parts. To prevent the unit from possible damage, do not use the unit for at least 2 hours when there is an extreme or sudden change in temperature.

## Place and Manner of Installation

- Do not place in hot locations, such as near heating equipment. Doing so could cause malfunction, and shorten the life of the projector.
- Avoid locations with oil or cigarette smoke. Doing so will dirty the optical parts, shortening their lives, and darkening the screen.
- Do not use this product in the upright position or tilt it up or down by more than 20° from level. Doing so may cause a failure or shorten the life of the product.
- Using this instrument near a TV or radio may cause interference to the images or audio sound. If this happens, move it away from the TV or radio.
- Moving the projector from a low-temperature room to a high-temperature room may cause condensation on the lens or internal parts in the instrument. If you continue to use it in that situation, the malfunction may result. Ensure to wait until the condensation naturally disappears.
- In a high altitude location where air is thin, cooling efficiency is reduced so use the projector with **[Fan mode]** set to **[High]**. [p.36](#)
- Only plug the power cord into outlets rated for use with the power cord's specified voltage range. Do not overload extension cords or table taps as this can result in fire or electric shock.
- Route the power cable or the connecting cable away from where people could trip over it. The projector may fall down, which could result in severe injury.
- Be sure the power cord is easily reached for unplugging in case of emergency. Do not place any obstacles near a wall outlet in which the cord is plugged.

## Avoid Volatile Liquid

Do not use volatile liquids, such as an insect spray, near the unit. Do not leave rubber or plastic products touching the unit for a long time. They will leave marks on the finish. Do not use a chemically saturated cloth.

# EXEMPTION CLAUSES

---

- Toshiba Corporation bears no responsibility in the case of damages arising from natural disaster such as earthquakes, lightning, etc., fire not liable to Toshiba Corporation, acts by third parties, other accidents, or use under abnormal conditions including erroneous or improper operation and other problems.
- Toshiba Corporation bears no responsibility for incidental damages (lost profit, work interruption, corruption or loss of the memory contents, etc.) arising from the use of or the inability to use this unit.
- Toshiba Corporation accepts no liability whatsoever for any damages arising from not having followed the descriptions in this Instruction Manual.
- Toshiba Corporation accepts no liability whatsoever for any damages arising from malfunctions arising from combination with equipment or software that is not related to Toshiba Corporation.

In the spaces provided below, record the Model and Serial No. located at the bottom of your projector.

Model No. \_\_\_\_\_ Serial No. \_\_\_\_\_

Retain this information for future reference.

# OTHER INFORMATION

## Copyrights

Showing or transmitting commercial imaging software or broadcast or cable-broad casting programs with the purpose of other than the personal and private viewing, including modifying images using the freeze function, or displaying with the varying aspect ratio of the images, could violate the direct or indirect copyrights of the imaging software or broadcast program, etc., if done without first consulting with the copyright holder. For this reason, please take appropriate measures before performing one of the actions listed above, including obtaining a license from the copyright holder.

## Disposal

This product contains substances which are harmful to humans and the environment.

- The lamp contains mercury.

Please dispose of this product or used lamps in accordance with local regulations.

### Following information is only for EU-member states:

The use of the symbol indicates that this product may not be treated as household waste. By ensuring this product is disposed of correctly, you will help prevent potential negative consequences for the environment and human health, which could otherwise be caused by inappropriate waste handling of this product. For more detailed information about recycling of this product, please contact your local city office, your household waste disposal service or the shop where you purchased the product.



## Trademarks

- VGA, SVGA, XGA, SXGA, UXGA are trademarks or registered trademarks of International Business Machines Corporation.
- DLP® (Digital Light Processing) is a registered trademark of Texas Instruments, Inc.
- Macintosh is a registered trademark of Apple Computer, Inc.
- Windows is a registered trademark of Microsoft Corporation in the U.S. and other countries.
- Adobe is a registered trademark and Acrobat Reader is a trademark of Adobe Systems Incorporated.
- All other brand and product names are trademarks or registered trademarks of their respective companies.

## Notational Conventions Used in This Manual

- References to pages with related information are annotated as follows. For example, if making a reference to page 36: [p.36](#)
- The illustrations in this document are for reference purposes only and may not reflect your package exactly.

# REMOTE CONTROL BATTERIES

---

## Caution

- Never throw batteries into a fire.

Using the batteries improperly may cause them to explode or leak and lead to burn or injury. If battery-leaking fluid contacts skin, wash the fluid off immediately with clean water and consult a doctor. If the fluid is spilt on an instrument, avoid contact and wipe it off using tissue paper. (Dispose of the used tissue paper as flammable garbage after moistening with water.)

## Notes

- Be sure to use AAA (LR03) size batteries.
- Dispose of batteries in a designated disposal area.
- Attention should be drawn to the environmental aspects of battery disposal.
- Do not mix different battery types or combine used batteries with new ones.
- If the remote control does not operate correctly, or if the operating range becomes reduced, replace both batteries with new ones.
- If the batteries are dead or if you will not be using the remote control for a long time, remove the batteries to prevent battery acid from leaking into the battery compartment.



# CONTENTS

---

## Before using

SAFETY PRECAUTIONS .....	2
IMPORTANT SAFETY INSTRUCTIONS .....	4
IMPORTANT PRECAUTIONS .....	9
EXEMPTION CLAUSES .....	10
OTHER INFORMATION .....	11
REMOTE CONTROL BATTERIES .....	12
CONTENTS .....	14

## Preparations

Checking the package contents .....	16
Names of each part on the main unit .....	17
Names of each part on the control panel and remote control .....	18
Label locations .....	20
Parts on the rear panel .....	20
Preparing and using the remote control .....	21
Operating a computer using the remote control .....	23
Placement .....	24
Connection .....	26

## Operations

Turning the power on and off .....	28
Basic operations .....	30
Using handy features .....	31
Using auto setting (Only for computer input) .....	31
Correcting the keystone distortion .....	31
Cutting off the picture and sound temporarily (Mute) .....	31
Freezing the image (Freeze) .....	32
Using the menus .....	33
How to use the menus .....	33
Image adjustment menu .....	34
Display setting menu .....	35
Default setting menu .....	36
Displaying Information (Status display) .....	37
Using USB Memory .....	38

## Maintenance

About lamp .....	42
Lamp replacement .....	42
Lens and main unit cleaning .....	45

## Others

Indicators .....	46
Before calling service personnel .....	47
Specifications .....	48
List of general specifications.....	48
Separately sold product .....	48
List of supported signals (RGB signals).....	49
List of supported signals (Video, S-Video signals) .....	50
Pin assignment of COMPUTER IN terminals .....	51
Pin assignment of S-VIDEO terminals.....	51

# Checking the package contents

Please make sure that the following items are included in the box, along with the main unit. If any item is missing, please contact the store immediately where you purchased the product.

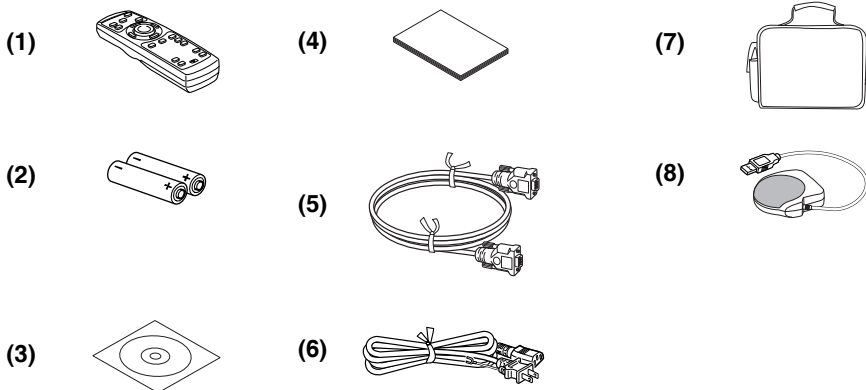

- |  |                                   |
|--|-----------------------------------|
| (1) Remote control                               | (5) RGB cable (3m) (See note)     |
| (2) LR03 (SIZE AAA) batteries for remote control | (6) Power cord (See note)         |
| (3) CD-ROM                                       | (7) Carrying bag                  |
| (4) Owner's Manual                               | (8) Mouse remote control receiver |

## Note

- The shape and number of supplied power cords vary depending on the product destination.
- To maintain original performance, make sure to use supplied cables.

## Save Original Packing Materials

The original shipping carton and packing materials will come in handy if you ever have to ship your projector. For maximum protection, repack the set as it was originally packed at the factory.

### ◆ The Supplied CD-ROM

The supplied CD-ROM contains an owner's manual, including information not available for the printed Owner's manual (Getting Started) in PDF format. (PDF: Portable Document Format) Please use Acrobat Reader 5 or more to view the manual.

#### ■ Adobe® Acrobat® Reader® or Adobe® Reader®

The supplied CD-ROM does not contain Acrobat® Reader®. If you can not read PDF files, please install Adobe Reader software in your computer by downloading it from the Adobe Systems website.

#### ■ Viewing the manual

Run the CD-ROM and double-click on **Start.pdf**. Acrobat® Reader® launches, and the menu screen of the Owner's manual appears. Click on your language. The Owner's Manual cover and list of bookmarks appear. Click on a bookmark title to view that section of the manual. Click on  to view a reference page with related information. See the Help menu for more information about Acrobat® Reader®.



# Names of each part on the main unit

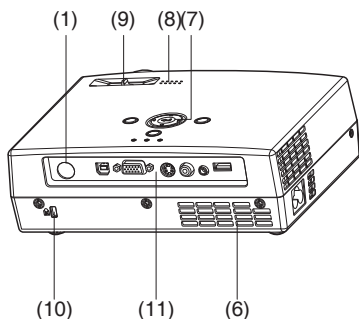

Back

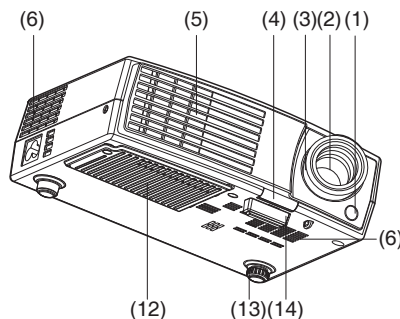

Front

Preparations

Name	:Function
(1) Infrared remote sensor	:Senses commands from the remote control. <a href="#">p.18</a>
(2) Lens	:Projects expanded image.
(3) Focus ring	:Adjusts the screen focus.
(4) Foot adjuster release button	:Press to set up or stow the foot adjuster. <a href="#">p.30</a>
(5) Air exhaust	:Expels air that has grown hot inside the projector.
(6) Air intake	:Draws in air from outside the projector for internal cool down.
(7) Control panel	:Operates the projector. <a href="#">p.18</a>
(8) Speaker	:Outputs audio sound.
(9) Zoom ring	:Adjusts the screen size.
(10) Antitheft lock hole	:Attach a safety cable or any other antitheft device.
(11) Rear panel	:Connects external devices. <a href="#">p.20</a>
(12) Lamp cover	:Remove to replace lamp. <a href="#">p.42</a>
(13) Tilt adjuster	:Adjusts the projector's horizontal tilt. <a href="#">p.30</a>
(14) Foot adjuster	:Adjusts the vertical projection angle. <a href="#">p.30</a>

# Names of each part on the control panel and remote control

## Control panel

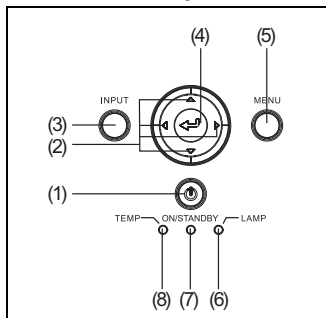

### CAUTION

- Do not look into the laser light source of the remote control or direct the laser pointer toward a person or a mirror.
- Handling and adjusting other than described here may lead to dangerous exposure to laser.

## Remote Control

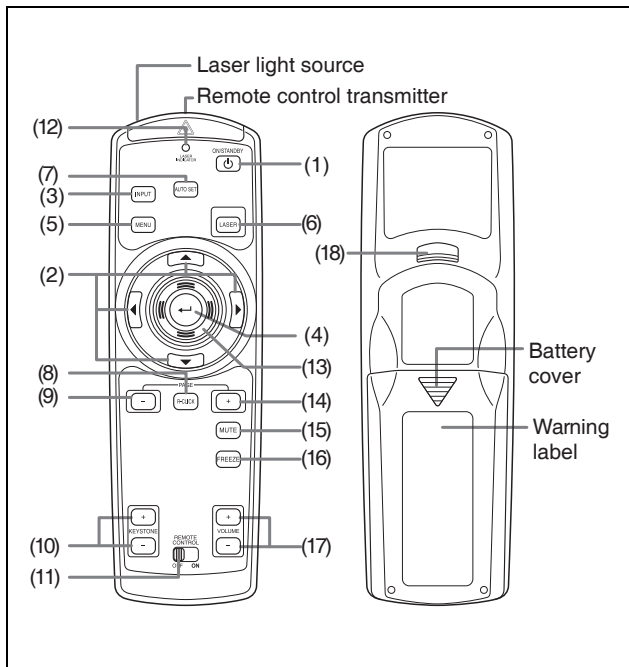

Name

:Main Function

### Control panel

- |                          |   |
|--------------------------|---|
| (1) ON/STANDBY button    | :Turns the power on/off (standby). <a href="#">p.28</a>                     |
| (2) Selection buttons    | :Menu selections and adjustments, volume control, etc. <a href="#">p.33</a> |
| (3) INPUT button         | :Selects input. <a href="#">p.30</a>  |
| (4) ENTER button         | :Accepts the selected mode.   |
| (5) MENU button          | :Displays menus. <a href="#">p.33</a>                                       |
| (6) LAMP indicator       | :Displays lamp mode. <a href="#">p.29</a>                                   |
| (7) ON/STANDBY indicator | :Displays whether power is on or off. <a href="#">p.29</a>                  |
| (8) TEMP indicator       | :Lights when internal temperature is too high. <a href="#">p.28</a>         |

### Remote control

- |                       |   |
|-----------------------|---|
| (1) ON/STANDBY button | :Turns the power on/off (standby). <a href="#">p.28</a>                     |
| (2) Selection buttons | :Menu selections and adjustments, volume control, etc. <a href="#">p.33</a> |
| (3) INPUT button      | :Selects input. <a href="#">p.30</a>  |
| (4) ENTER button      | :Accepts the selected mode.   |
| (5) MENU button       | :Displays menus. <a href="#">p.33</a>                                       |

Name	:Main Function
(6) LASER button	:Shows a laser pointer.
(7) AUTO SET button	:Sets up analog input from computer. <a href="#">p.31</a>
(8) R-CLICK button	:Functions as right-click of a mouse. <a href="#">p.23</a>
(9) PAGE- button	:Goes back PowerPoint® slides. <a href="#">p.23</a>
(10) KEYSTONE + / - button	:Adjusts keystone distortion. <a href="#">p.31</a>
(11) Remote control ON/OFF switch	:Switches on/off the remote control. <a href="#">p.21</a>
(12) Laser indicator	:Lights when laser is on.
(13) Mouse control button	:Controls a mouse pointer. <a href="#">p.23</a>
(14) PAGE+ button	:Proceeds PowerPoint® slides. <a href="#">p.23</a>
(15) MUTE button	:Cuts off the picture and sound temporarily. <a href="#">p.31</a>
(16) FREEZE button	:Pauses image. <a href="#">p.32</a>
(17) VOLUME + / - button	:Adjusts the volume level.
(18) L-CLICK button	:Functions as left-click of a mouse. <a href="#">p.23</a>

**Note**

- For the remainder of this manual, buttons are referred to as follows:  
 Selection buttons ⇒ ▲ ▼ ◀ ▶ ; ENTER button ⇒ ↵

# Label locations

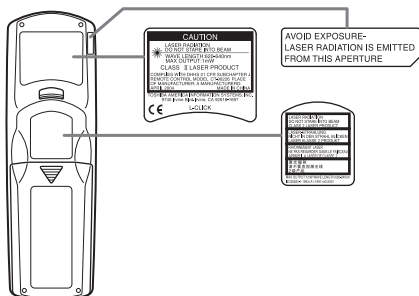

**Caution** - use of controls or adjustments or performance of procedures other than those specified herein may result in hazardous radiation exposure.

# Parts on the rear panel

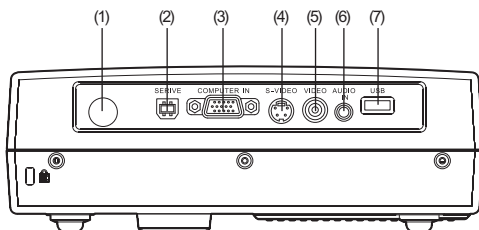

Name	:Main Function
(1) Infrared remote sensor	:Senses commands from the remote control.
(2) SERVICE	:Firmware update.
(3) COMPUTER IN terminal	:Input analog RGB signal from a computer or other source, or a component video signal (Y/Pb/Pr) from video equipment.
(4) S-VIDEO terminal	:Input S video signals from video equipment.
(5) VIDEO terminal	:Input video signals from video equipment.
(6) AUDIO IN terminal	:Input audio signals.
(7) USB terminal	:Connects a commercial USB memory. <a href="#">p.38</a>

# Preparing and using the remote control

## ■ Loading dry-cell batteries into the remote control

### ① Remove the battery cover.

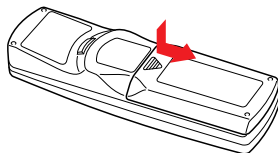

### ② Insert the dry-cell batteries.

Be sure to align the plus and minus ends of the batteries properly.

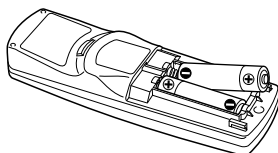

Two batteries (LR03, SIZE AAA) are used.

### ③ Replace the battery cover.

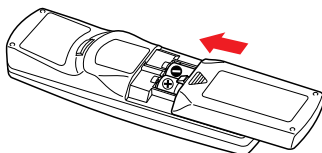

## ■ Operating the remote control

Turn on the ON/OFF switch of the remote control.

Point toward the projector's infrared remote sensor, and press a button on the remote control.

- Operating the projector from the front

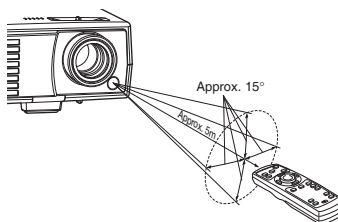

- Operating the projector from the rear

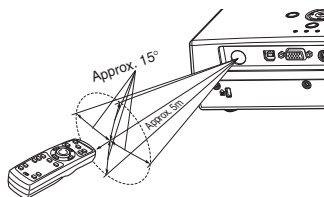

## Preparing and using the remote control (Continued)

---

### **■ Dry-cell batteries**

- Before using the batteries, be sure to observe the Safety Precautions described in previous pages.
- Remove batteries from remote control when not using for extended periods.
- If the remote control stops working, or if its range decreases, replace all the batteries with new ones.
- Keep the batteries away from the reach of children. Batteries are choking hazards and can be very dangerous if swallowed. If the batteries are swallowed, seek medical assistance immediately.

### **■ The remote control**

- Turn off the ON/OFF switch of the remote control when not in use or to store in baggage.
- The remote control may fail to operate if the infrared remote sensor is exposed to bright sunlight or fluorescent lighting.
- Do not drop or bang.
- Do not leave in hot or humid locations.
- Do not get wet or place on top of wet objects.
- Do not take apart.
- In rare cases, ambient conditions could impede the operation of the remote control. If this happens, point the remote control at the main unit again, and repeat the operation.

# Operating a computer using the remote control

A computer can be operated using the projector's remote control. This function is available on any computer with the Windows® 98/98SE, Windows® Me, Windows® 2000, Windows® XP, or Windows Vista™ OS, that is equipped with a USB port which can support USB1.1 (The mouse remote control receiver is also supported on OS 9 or OS X for the Macintosh). However, please note that Toshiba does not guarantee the operation of all computers.

## 1 Connecting a computer

Connect the mouse remote control receiver (supplied) to a computer.

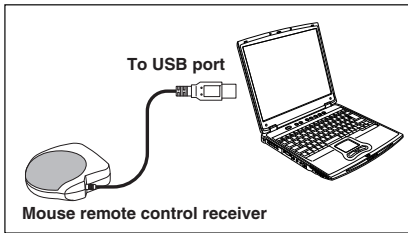

The remote control may fail to operate if the mouse remote control receiver is exposed to bright sunlight or fluorescent lighting. In such a case, change position or direction of the mouse remote control receiver and retry.

## 2 Operating a computer

Operate remote control's buttons towards the mouse remote control receiver.

### • Moving the mouse pointer

Press the mouse control button in the direction you wish the mouse pointer to move, then press.

### • To left click

Press the L-CLICK button.

### • To right click

Press the R-CLICK button.

### • To drag and drop

Holding down the L-CLICK button, move the mouse control button until the mouse pointer is over the desired location, then release the L-CLICK button.

### • Using the computer's page up [↑] and down [↓] function

Press the PAGE+ and PAGE- buttons to switch PowerPoint® slides.

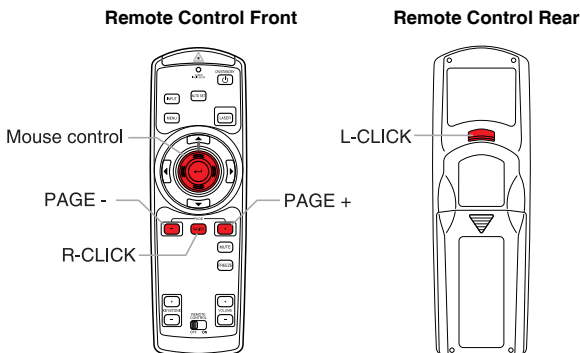

# Placement

## Placement Styles

As shown in the figures below, this device can be placed in 2 different styles. The factory setting is "floor-mounted front projection." Set the **[Projection mode]** in the **Default setting menu** [p.36](#), in accordance with your needs.

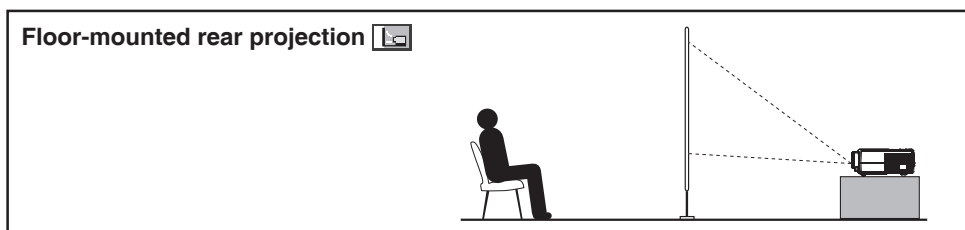
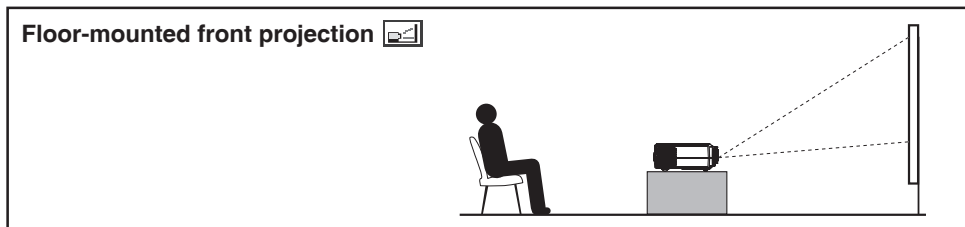

### WARNING

- Always obey the instructions listed in **IMPORTANT SAFETY INSTRUCTIONS** when placing the unit. Attempting to clean or replace the lamp in a high location by yourself may cause you to fall, resulting in injury.



## Projection Distance and Size

Use the figures, tables, and formulas below to determine the projection size and projection distance. (Projection sizes are approximate values for full-size picture with no keystone adjustment.)

Screen **As seen from above**

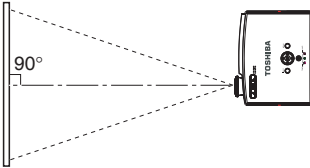

**As seen from the side**

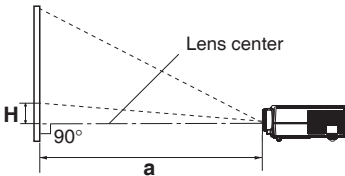

projection size (inches)	projection distance a (m)		height (H) (cm)	
	min length (zooming max)	max length (zooming min)	min length (zooming max)	max length (zooming min)
40	1.6	1.8	8.7	8.8
60	2.3	2.8	12.5	13.1
80	3.1	3.7	16.8	17.3
100	4	4.7	21.7	21.9
150	6	7.3	32.5	32.9
200	8	9.4	41.9	43.9
250	10	11.7	52.4	54.8
300	12	14.1	65	65.8

projection size (inches)	projection distance a (inch)		height (H) (inch)	
	min length (zooming max)	max length (zooming min)	min length (zooming max)	max length (zooming min)
40	63	71	3	3
60	91	110	5	5
80	120	150	7	7
100	160	190	9	9
150	240	290	13	13
200	320	370	16	17
250	390	460	21	22
300	470	560	26	26

1 inch=2.54 cm

**a** is the distance between the lens and the screen, and corresponds to a range of 1.6m to 13.7m (63.0 inches to 539.4 inches). **H** is the height from the image bottom to the center of the lens.

# Connection

## Before connection

- Read the owner's manual of the device you are connecting to the projector.
- Some types of computer cannot be used or connected to this projector.  
Check for an RGB output terminal, supported signal [p.49](#), etc.
- Turn off the power of both devices before connecting.
- The figures are sample connections. This does not mean that all of these devices can or must be connected simultaneously.

## Connecting with computers

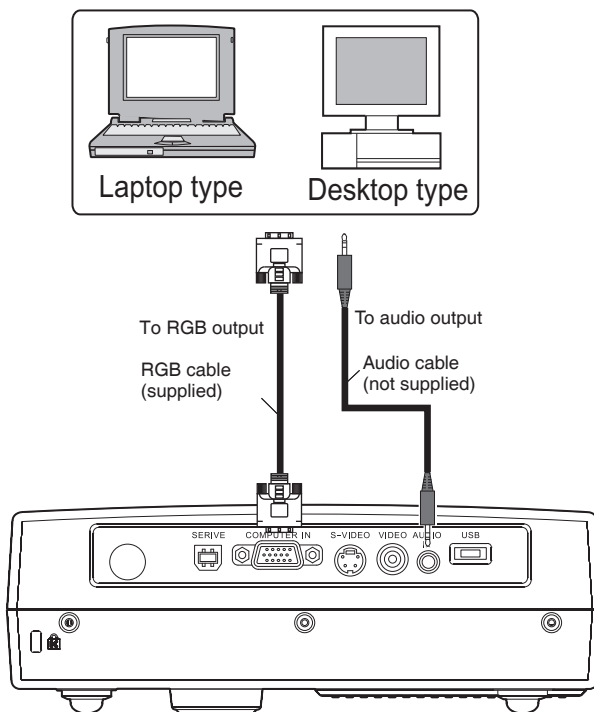

### Note

- Moving pictures played back on computers using DVD software may appear unnatural if it is projected with this projector, but it is not a malfunction.

## Connecting with AV equipment

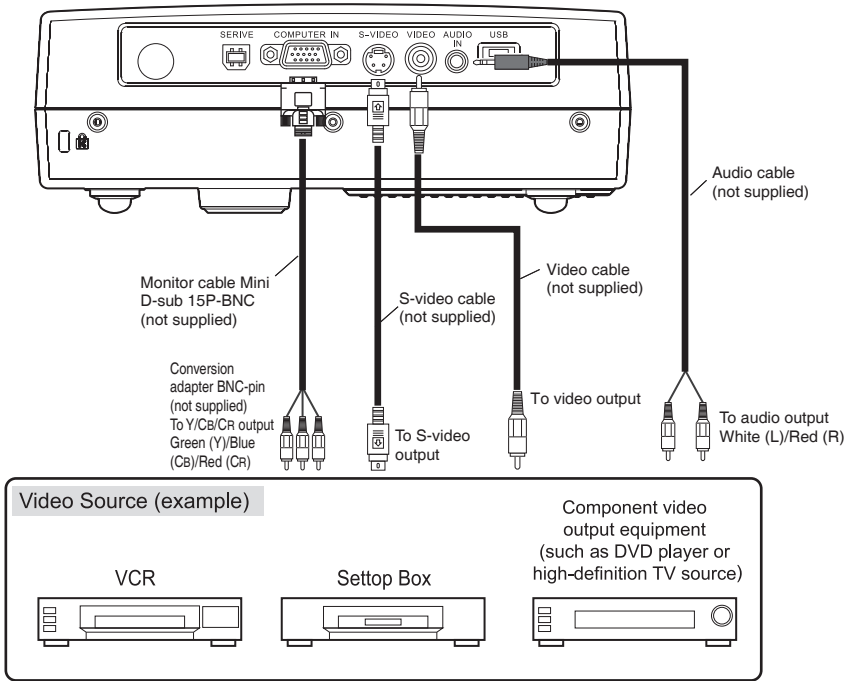

# Turning the power on and off

## ■ Connecting the power cord

- ❶ Insert the power cord connector into the AC IN socket of the projector.
- ❷ Insert the power cord plug into a wall or other power outlet.

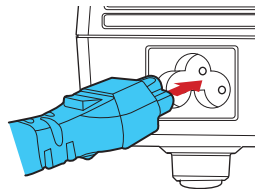

The TEMP, ON/STANDBY and LAMP indicator will flash, and then ON/STANDBY will only remain flashing, indicating standby mode.

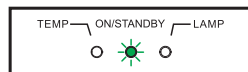

## ■ Removing the lens cover

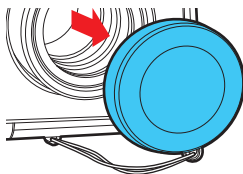

Be sure to remove the lens cover when the power is turned on. If it is left on, it could become deformed due to heat.

## ■ Turning the power on

### ❶ Press the ON/STANDBY button.

The power turns on and the ON/STANDBY indicator lights. After a moment, the start-up screen appears.

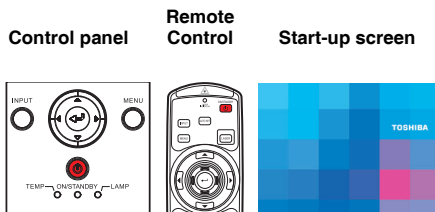

### ⚠ CAUTION

- **Do not look into the lens while the lamp is on.** The strong light from the lamp may cause damage to your eyesight.
- **Do not block the air intake or exhaust.** Doing so could cause a fire due to internal overheating.
- **Do not place your hands, face, or other objects near the air exhaust, the lamp cover or the bottom of the unit.** Doing so could cause burns, deform/break the object.

## Note

- The start-up screen will disappear after a moment. You can also configure the start-up screen not to appear via the **Default setting menu** [p.36](#).
- The first time you use the projector after purchase, the language selection menu will be displayed.
- Do not touch the lens directly with your hand. If fingerprints or stains are left on the projection lens surface, they may interfere with the projector's ability to project images on the screen.

## Turning the power off

### 1 Press the ON/STANDBY button.

A message appears on the screen, confirming that you wish to shut off the power. This message will disappear after a moment. (This operation is no longer valid after the message disappears.)

### 2 Press the ON/STANDBY button again.

The screen turns off, but the internal cooling fan continues to operate for a short while. Then, the projector goes into standby mode.

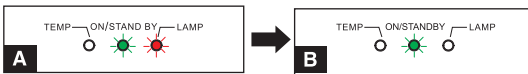

**A** During cooling, the ON/STANDBY and LAMP indicator flash. In this state, the power cannot be turned back on.

If you are in a hurry, there is no problem with unplugging the power cord in this state.

**B** In standby mode.

## Note

- The projector consumes about 8W of power in standby. We recommend that you unplug the power cord if you will not be using the projector for an extended period.

## Precaution

- If the power cord is unplugged before cooling is complete, give the lamp time (about 5 minutes) to cool before plugging it back in. If the lamp overheats, it may fail to light.

# Basic operations

## 1 Turn on the power.

Turn on the power by following the instructions in "Turning the power on" [p.28](#).

## 2 Activate the connected device.

Turn on and start the connected device such as a computer.

## 3 Press the INPUT button.

## 4 Adjust the focus.

Use the focus ring to adjust the focus.

## 5 Adjust the vertical projection angle.

Use the foot adjuster to adjust the vertical position of the projection image. See foot adjuster on [p.17](#).

## 6 Adjust the volume.

Adjust the volume from the remote control.

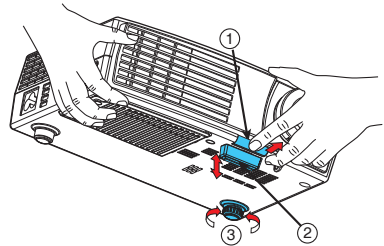

## Note

- Note that lamp characteristics may rarely cause the brightness to fluctuate slightly.
- A lamp is consumable item. If used for extended periods, images will appear dark, and the lamp could burn out. This is characteristic of a lamp, and is not malfunction. (The lifetime of the lamp depends on conditions of use.)
- The DLP® chip is made using extremely advanced technology, but there may be black spots (pixels that do not light) or bright spots (pixels that are constantly lit) on the panel. Please note that these are not malfunctions.
- Although this projector supports a wide range of RGB signals [p.49](#), any signal formats not matched to native resolution of this projector (XGA) will be expanded or shrunk, which will affect image quality slightly. To view high-quality images, setting the computer's external output to XGA is recommended.
- With some models of computer having LCD displays or the like, displaying images simultaneously on the projector and the monitor's display may prevent the images from displaying properly. If this happens, turn off the computer's LCD display. For information on how to turn off the LCD display, see the owner's manual of your computer.
- When [Auto input search] is set to [Off] in the **Default setting menu** (factory setting is [On]), the Input select menu appears if you press the INPUT button. If no signal is being input from the connected equipment or signal input is stopped while projecting, the **"No signal"** will appear.
- If a signal not supported by the projector is input, the **"Unsupport signal"** will appear.
- If an unavailable operation button is pressed, the  icon will appear.
- The factory setting for the OSD language is **"English"**, other languages can be selected in the **Default setting menu**. [p.36](#)

# Using handy features

## Using auto setting (Only for computer input)

This function automatically sets up the projector to the optimum state such as sampling phase, frequency and screen position for each type of the input signal by using simple operations.

Remote Control



### ■ Press the AUTO SET button on the remote control.

For computer input, the  icon will appear during processing.

#### ■ Note

- The image may not be projected or auto adjustment/setting may not be performed correctly for input signals other than those supported by the projector [p.49](#) , [p.50](#) .

## Correcting the keystone distortion

When the projector placement angle against the screen is changed while projecting the image, the picture will undergo keystone (trapezoidal) distortion. This projector can correct for this keystone distortion.

Remote Control



### ■ Press the remote control's KEYSTONE + / - button.

You can also select [Keystone] in the **Image adjustment menu** [p.34](#) .

#### ■ Note

- Depending on the amount of keystone adjustment and the content of images, some information may be lost, or the picture quality may suffer.

## Cutting off the picture and sound temporarily (Mute)

When you want to project the images of another projector, overhead projector, etc. temporarily, this projector's images and sound can be turned off.

Remote Control



### ■ Press the remote control's MUTE button.

The picture and sound are cut off. (The Mute function is released when pressing the **MUTE** button again.)

#### ■ Note

- The icon  will appear while mute is in effect.
- Operating any other functions will also cancel the muting.

## Using handy features (continued)

---

### Freezing the image (Freeze)

Projected image can be frozen. This function is used to pause video during a presentation, etc.

Remote Control



- **Press the FREEZE button on the remote control.**

The picture pauses. (The Freeze function is released when pressing the **FREEZE** button again.)

- **Note**

- The  icon will appear while freeze is in effect.
- Other operation will also release the freeze.
- Although an image is frozen on the projector, the pictures are running on the video or other equipment.
- If you use this function on commercial video software, broadcast or cable-broadcasting except for the purpose of your private viewing and listening, it may infringe the copyright protected by the copyright laws.



# Using the menus

You can call up on-screen menus, and make adjustments and settings using the operation buttons on the control panel (main unit side) and remote control [p.18](#) , [p.19](#) .

## How to use the menus

The menu shown below is for operation instructions purposes and might differ from the actual display.

**1. Press the MENU button.** The Image adjustment menu appears.

**2. Select a Category**

Select a category by using

There are following 4 categories.

- Image adjustment menu** [p.34](#)
- Display setting menu** [p.35](#)
- Default setting menu** [p.36](#)
- Status display menu** [p.37](#)

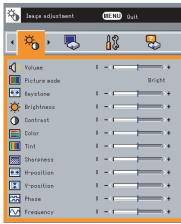

Displays the current adjustments and settings of the selected category. Item shown with gray cannot be adjusted with the current input source.

**3. Adjustments & Settings**

Press the button.

Item  
Adjustment/Setting Value

Toggle items with key. Push key to select item.

These marks signify that there are options. Press to display a list of options.

The figure shows displays given for operation instructions purposes. As the display may differ depending on the item, use the following pages as a reference.

**5. End**  
**Press the MENU button**

The menu disappears. (The menu will disappear automatically after 30 seconds, if no operation is conducted.)

**4. Back**  
**MENU button**

Operations

## Using the menus (continued)

































### Image adjustment menu

Use this menu to set or adjust image-related items. Items that can be set or adjusted are marked with “**Yes**”, and those that cannot are marked with “**No**”. (When an item is masked, it indicates that you cannot select for the current input.)

Item	Description	Computer (D-SUB)		Video	USB
		RGB	Y/Pb/Pr		
<b>Volume</b>	Decrease or increase the Volume with ◀ ▶.	Yes	Yes	Yes	Yes
<b>Picture mode</b>	Press ⏻. Toggle the picture mode with ◀ ▶. Bright/Standard/True color	Yes	Yes	Yes	Yes
<b>Keystone</b>	Correct the keystone (trapezoid) distortion of the screen. Screen shrinking ◀ ▶ Screen shrinking at bottom at top	Yes	Yes	Yes	Yes
<b>Brightness</b>	Adjust the brightness of the image. Darker ◀ ▶ Brighter	Yes	Yes	Yes	Yes
<b>Contrast</b>	Adjust the image contrast. Lower ◀ ▶ Higher	Yes	Yes	Yes	Yes
<b>Color</b>	Adjust the color of the image. Lighter ◀ ▶ Deeper	No	Yes	Yes	No
<b>Tint</b>	Adjust the image to an appropriate tint. Reddish ◀ ▶ Greenish	No	Yes	Yes	No
<b>Sharpness</b>	Adjust the sharpness of the image. Softer ◀ ▶ Sharper	No	Yes	Yes	No
<b>H-position</b>	Adjust the horizontal position of the image. Move left ◀ ▶ Move right	Yes	No	No	No
<b>V-position</b>	Adjust the vertical position of the image. Move down ◀ ▶ Move up	Yes	No	No	No
<b>Phase</b>	Adjust with ◀ ▶ to eliminate flicker.	Yes	No	No	No
<b>Frequency</b>	Adjust with ◀ ▶ to eliminate periodic patterns and flickering when many vertical lines appear on the screen.	Yes	No	No	No

\*1: [Tint] can be displayed and adjusted only when the video signal is [NTSC] or [NTSC4.43].

## Display setting menu



























Item	Description	RGB	Y/Ps/Pr	Video	USB
 <b>Quick Start</b>	Set to "On", then plug in the USB device will enter the Slideshow mode. Set to "Off", then plug in the USB device will enter the File view mode.	No	No	No	Yes
 <b>Slideshow</b>	Set slideshow mode. Auto   Manual	No	No	No	Yes
 <b>Interval</b>	Adjust the interval time in Slideshow auto mode. Short   Long	No	No	No	Yes
 <b>Slideshow loop</b>	Set loop function of the slideshow. On   Off	No	No	No	Yes
 <b>Display effect</b>	Set transition effect of the slideshow. [  : Enter setting mode ] → [   : Selection ] → [  : Apply ] None/Wipe/Dissolve/Cover <sup>[Notes]</sup>	No	No	No	Yes
 <b>Screen size</b> <sup>[Note]</sup>	Screen size setting.  (Full) < >  (Wide) < >  (Thru)  (Full): Display with 1024 x 768 resolution  (Wide): Wide-screen display  (Thru): Display in the native resolution	Yes	Yes	Yes	No
 <b>Up/down shift</b>	Adjust the vertical position when <b>Screen size</b> is set to "Wide". Lower   Higher	Yes	Yes	Yes	No
 <b>Background</b>	Screen to display when there is no input signal. (Logo)  < >  (Blue) < >  (Black)	Yes	Yes	Yes	Yes
 <b>Icon</b>	Display icons as function guides. On   Off	Yes	Yes	Yes	Yes

### Note

- **[Display effect]**  
None: displays screen without special effects.  
Wipe: screen scrolls in from the top or bottom.  
Dissolve: adds dissolve effect to screen.  
Cover: screen overlaps previous image
- If you use the screen size setting function on commercial video software, broadcast or cable-broadcasting programs to display images with the varying aspect ratio except for the purpose of your private viewing and listening, it may infringe the copyright protected by the copyright laws.

# Using the menus (continued)







## Default setting menu

Item	Description	RGB	Y/Pb/Pr	Video	USB
 <b>Projection mode</b>	Sets projection mode in accordance with Placement Styles. <a href="#">p.24</a>  (Standard) ◀ ▶  (Rear)	Yes	Yes	Yes	Yes
 <b>Language</b>	Select one of the languages below for the menu and messages. [  : Enter setting mode ] → [   : Selection ] → [  : Apply ]  English/ Français/ Deutsch/ Italiano/ Español/ Português/ Русский/ Svenska/ Türkçe/ Polski/ Dansk/ Čeština/ Magyar/ Nederlands/ Suomi/ Norsk/ Ελληνικά/ Română/ 日本語/ 中文(简体字)/ 中文(繁體字)/ Bahasa Indonesia	Yes	Yes	Yes	Yes
 <b>Start-up screen</b>	Display start-up screen when power is turned on. On   Off	Yes	Yes	Yes	Yes
 <b>Auto input search</b>	Set whether the input with signals is only selected or not. On   Off	Yes	Yes	Yes	Yes
 <b>Fan mode</b> <sup>[Note]</sup>	Sets the cooling fan speed. Standard   High	Yes	Yes	Yes	Yes
 <b>Lamp power</b>	Sets the lamp power. Normal   Low	Yes	Yes	Yes	Yes
 <b>Power on</b> <sup>[Note]</sup>	Sets whether to turn on the power when the <b>ON/STANDBY</b> button is pressed (Manual), or when the power is supplied (Auto). Manual   Auto	Yes	Yes	Yes	Yes
 <b>Reset all</b>	Press  . (The language is not reset.) Resets all adjustments and settings to their factory settings. Yes   No	Yes	Yes	Yes	Yes

### Note

- Set **Fan mode** to **[High]** when the altitude is 600m (2,000 ft.) or higher, however, do not set **Fan mode** to **[High]** when using the projector at a lower altitude.
- Note that if **[Power on]** is set to **[Auto]**, then if the power is supplied when restored after a power outage, the projector will come on.

## Displaying Information (Status display)

Item	Description	RGB	Y/Pb/Pr	Video	USB
 <b>Input</b>	Input source name.	Yes	Yes	Yes	Yes
 <b>Resolution</b>	Resolution (in dots).	Yes	No	No	No
 <b>Video mode</b>	Color method of video signal.	No	Yes	Yes	Yes
 <b>Picture mode</b>	Picture mode setting.	Yes	Yes	Yes	Yes
 <b>Lamp time</b> <sup>[Note]</sup>	Lamp elapsed time.	Yes	Yes	Yes	Yes
 <b>Version</b>	Firmware version. <sup>[Note]</sup>	Yes	Yes	Yes	Yes

### Note

- The mode of supported RGB signals [p.49](#) is shown.
- **[Firmware version]** shows the version of the projector's internal control program. This version is referred to for customer service, etc.
- Displays **[Lamp time]** as a measure of when the lamp should be replaced. (Cannot be used as a counter of guaranteed lamp time.) When the displayed time approaches 2,000 hours, consult with a dealer about getting replacement for:TLPLP20 (sold separately).

# Using USB Memory

## Connect the USB memory to the projector and select USB input

- ❶ Press INPUT button to select USB source.
- ❷ Plug the USB memory to the USB port.

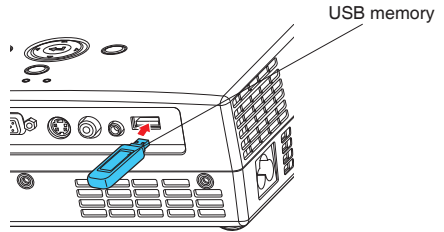

### Note

- USB HDD or hub is not supported.
- If **Quick Start** is set to **"On"** and the source other than USB memory is input, the slideshow will automatically play back when USB memory is plugged in. After that if the source is switched to USB, the first slide may not be displayed or the slideshow may be ended.

## File View Mode

- ❶ When **Quick Start** sets to **"On"** and there is JPEG file(s) in the root folder of the USB memory, the slideshow starts automatically [p.35](#).
- ❷ When **Quick Start** sets to **"Off"** or there is no JPEG file in the root folder of the USB memory, the file list appears as below (file view mode).

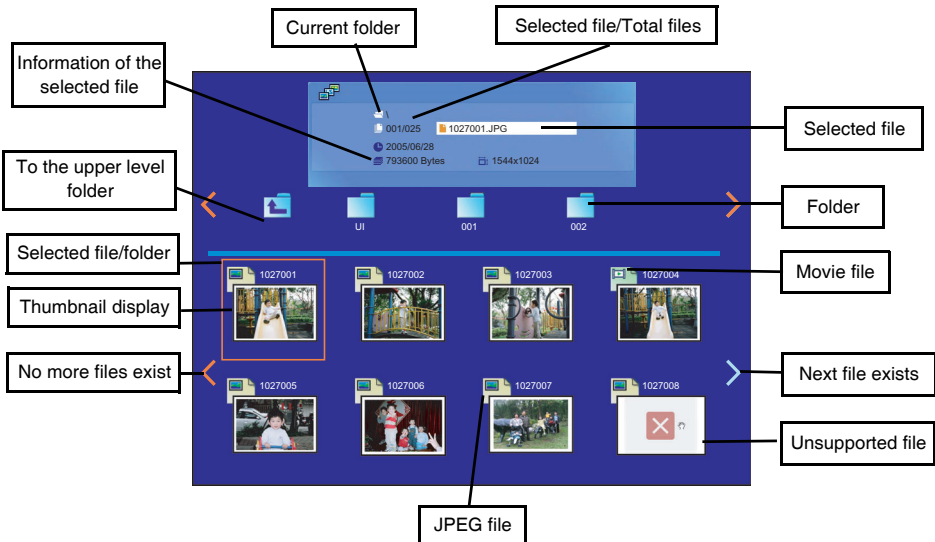

### Note

- If there are many files in the folder, it takes long time to show the file names and thumbnails.
- 2-byte characters are not supported and will be displayed as "?".
- Only folders, JPEG files or supported movie files can be displayed in the file list, other file formats are not displayed.
- Thumbnail may not be displayed due to different file formats.

## Slideshow Mode / Display of movie files

### 1 Slideshow Mode / Display of movie files

- Quick Start



When the projector sets to the USB input and "Quick start" to "On" [p.35](#), the slideshow starts with JPEG files in the root folder of the USB memory.

- Start from file view mode

When a JPEG file is selected and press the  button in the file view mode, slideshow starts from the selected JPEG file. Movie files can also be played by this operation.

- Movie file is not played in slideshow even a movie file is put in the same folder. If you want to play back movie file, select the file with movie icon and press the  button.

### 2 Slideshow operation

In the slideshow mode, JPEG files display on the screen fully. To change the files, select  or . The picture displayed in the same order as displayed in the file view mode.

It takes several seconds to display the next slide.  appears when reading the next file. The reading time varies and depends on the file size.

When "Slideshow" sets to "Auto" in the **Display setting menu** [p.35](#), the slide changed automatically when displaying. Display time also can be changed in "Interval" setting in the **Display setting menu** [p.35](#). Interval time doesn't include reading time of the next file, so it takes longer to display the next picture than the setting.

After showing the last JPEG picture,  will be shown in the picture. This indicates the end of the slideshow. The slideshow ends and the projector enters in the file view mode.

When "Slideshow loop" sets to "On", the slideshow starts from the first file again after displaying the last file.

When JPEG file has a failure or unsupported format,  appears on the current picture and the projector automatically starts to read the next JPEG file.

Picture transition effect is available in the slideshow. The following four modes can be selected in "Display effect" in the default setting menu.

- None: displays screen without special effects.
- Wipe: screen scrolls in from the top or bottom.
- Dissolve: adds dissolve effect to screen.
- Cover: screen overlaps previous image.

### Note

- If you switch to another source during slideshow operation, the slideshow will not stop.

## Using USB Memory (continued)

---

### ③ Exit Slideshow / Stop playing movie file

Press  button to exit slideshow when slideshow is in operation or to stop playing movie file when the movie file is playing back.

#### Note

- With USB memory function, the projector may not accept any operations for a short time after the movie file is played back. In this state, please wait for a while without performing any operations.
- There is no sound output during slideshow. When playing back the movie file, the sound will be played back.
- The sound may not be played back when playing back the movie file due to file formats.
- Some movie files may not be played back smoothly due to different movie file formats.

## About USB memory function

### ① The USB terminal

The USB terminal of the projector is USB 1.1 compliant, which can connect with a USB memory.

### ② USB memory

- 2GB limited USB memory size.
- Do not support USB HDD (Hard disk).
- Do not support USB hub.

### ③ USB devices whose operation has been verified.

TOSHIBA does not guarantee the operation of all listed USB devices.

TOSHIBA USB memory :U2E series (256MB, 512MB, 2GB)

SanDisk USB memory :SDCZ4 series (1GB, 2GB)

SanDisk USB memory :SDCZ6 series (1GB)

SanDisk USB memory :SDCZ7 series (2GB)

#### Note

- This projector does not support all USB memories.



④ Backing up the data

Toshiba recommends that you back up the data saved in the memory PC card, the USB memory, and in the memory card onto your computer before use. (Toshiba assumes no liability for losses incurred by data lost through the use of this projector.)

⑤ JPEG files

- Supported file extensions are .jpg and .JPG.
- Some JPEG files such as interlaced JPEG are not supported. Maximum resolution is 4096 x 2246.

⑥ Movie files

The following are the supported Movie files and Maximum resolution.

Format	Max. Resolution	Extension
Motion JPEG	352 x 288	.MOV/.mov
		.AVI/.avi
MPEG-1	640 x 480	.MPG/.mpg

- Since many different types of movie formats exist, this projector can't play a movie file when its format is not supported even if it has a supported extension. For detail information about a movie format of the file, refer to user's manual of the equipment or software that is used for making the file.

⑦ Folders and files

- Folders are limited to 3 levels.
- The number of folders in each folder is limited to 127.
- The number of files in each folder is limited to 512.

# About lamp

---

The product's light source is a mercury lamp that lights at increased internal pressure. Be sure to fully understand the following characteristics of the lamp and handle it with extreme care.

- The lamp may burst with a loud noise due to impact or deterioration, or fail to light at the expiration of its life.
- How long it takes before the lamp bursts or the life expires may vary greatly by lamp. Some may burst shortly after first use.
- Burst is likely to happen if the lamp is used after the replacement period has elapsed.
- When the lamp bursts, the broken pieces of glass may get inside the product or be released outside from the openings for ventilation.
- When the lamp bursts, a slight amount of mercury gas enclosed in the lamp along with glass dust may be released from the openings for ventilation.
- **Immediately replace the lamp when a sign appears on the screen.**
  - When the replacement time approaches, a message will appear on the screen.
  - The risk of burst will increase if the lamp is continuously used without being replaced.
  - Frequently check the used hours and prepare spares when the replacement time approaches. (Refer to "Status display" [p.37](#) .)
- **When the lamp is broken**
  - If glass components, including a lamp and a lens, should break, handle the broken pieces with care to avoid injury and contact your dealer for repair service.
  - In the event of lamp burst, unplug the product from the wall outlet, leave and completely ventilate the room. Then, thoroughly clean the area around the projector and discard any edible items placed in that area.
  - When the lamp bursts, consult a doctor if glass dust or mercury gas gets into your eyes or you breathe it.

## Lamp replacement

---

A lamp is consumable supply. If used for extended periods, images will appear dark, and the lamp could burn out. This is characteristic of a lamp, and is not malfunction. (The lifetime of the lamp depends on condition of use.) If this happens, replace it with a new one.



### WARNING

- **When replacing, always use lamp "TLPLP20" (sold separately).**



### CAUTION

- **If you have been using the projector, the lamp will be very hot, and may cause burn injuries.**  
Wait for the lamp to cool (for longer than 1 hour) before replacing it.
- **If the lamp should break, please handle with care to avoid injury due to broken pieces and contact your dealer for repair service.**

## Lamp replacement (Continued)

- 1 **Unplug power cord.**
- 2 **Wait until lamp is sufficiently cooled.**

Wait for at least 1 hour.

- 3 **Remove the lamp cover.**

Loosen the screw, raise the lamp cover with your fingers as shown to remove the lamp cover. Use care to avoid any damage to nails and/or tip of your finger(s). If you have any difficulty in removal, you can use a screwdriver or any other smaller tool for your convenience.

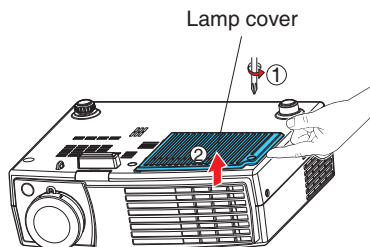

- 4 **Pull out the lamp.**

Loosen the two lamp locking screws, pull up the handle, and remove the lamp.

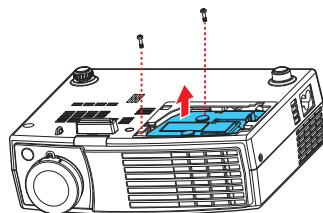

- 5 **Mount the new lamp.**

Align the orientation, press down the new lamp until the bottom is reached, and lock in place using the two lamp locking screws.

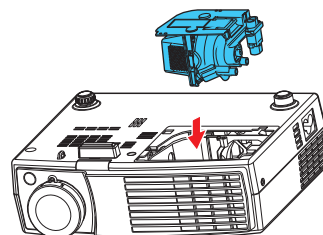

- 6 **Replace the lamp cover.**

Align the cover, and press it in, then tighten the screw loosened in step 3 until the lamp cover is no longer loose. (Be sure to replace the lamp cover.)

- 7 **Reset the lamp timer.**

See the lamp's manual for instructions on resetting the lamp timer.

## Lamp replacement (Continued)

---

### ■ Notes and Precautions

- The **Lamp time** item in the **Status display** menu indicates the time of lamp use (as a rough guide). [p.37](#)
- It is recommended that the lamp be replaced after 2,000 hours of use. When [**Lamp time**] reaches 2,000 hours, a message will appear. (After 2,000 hours, they will appear when the power is on at the first time every 100 hours.) This display disappears when you press the [MENU] button.
- Attach the lamp cover correctly so that it is not loose. If it is not attached correctly, the projector may fail to be powered on or the lamp may fail to come on.
- Always replace the lamp with a new one.
- The lamp is made out of glass. Do not touch the glass surface with your bare hands, bang it, or scratch it. (Dirt, jolts, scratches and the like could break the lamp.)

### ■ Used Lamps

This projector's lamps contain trace amounts of environmentally harmful inorganic mercury. Be careful not to break used lamps, and dispose of them in accordance with local regulations.

# Lens and main unit cleaning

## ■ Lens cleaning

- Clean the lens with a commercially available blower and/or lens cleaner.
- The lens is easily scratched, so do not rub it with hard objects, or strike it.

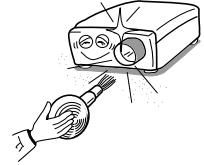

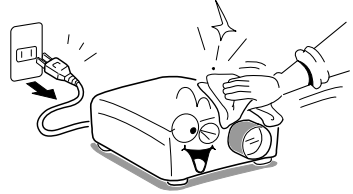

## ■ Main unit cleaning

- Clean the main unit after unplugging the power cord.
- Wipe dirt off the main unit gently with a soft cloth.
- Do not wipe the main unit with a damp cloth. Doing so may allow water to get inside, resulting in an electric shock or failure.
- Do not use benzene, thinner and the like as they may deform or discolor the unit or damage the paint surface.
- Do not use a chemically saturated cloth.



# Indicators

State/ Problems	Icon/ Messages	Close Messages	LED Indicators	
			TEMP	LAMP
Environment overheat			On	
Fan lock				
System error			F2	F2
Lamp life time	The lamp life is ending.	Press any key		
Lamp error				On

F2: Flash 2Hz

# Before calling service personnel

If you think something is wrong, check the followings before contacting customer service. Please see "Indicators" [p.46](#) as well.

If This Happens	Check
<b>No power</b>	<ul style="list-style-type: none"> <li>Is the power cord plugged in? Is it connected to the projector?</li> <li>Is the lamp cover open?</li> </ul>
<b>Power is lost during use</b>	<ul style="list-style-type: none"> <li>Is the ambient temperature high?</li> <li>Is the air intake or air exhaust blocked?</li> </ul>
<b>No picture</b>	<ul style="list-style-type: none"> <li>Is the projector turned on?</li> <li>Are the connections set up correctly? <a href="#">p.26</a> , <a href="#">p.27</a></li> <li>Are all the connected devices functioning properly?</li> <li>Is the mute function on? <a href="#">p.32</a></li> <li>Is the brightness setting minimized? <a href="#">p.39</a></li> </ul>
<b>No audio</b>	<ul style="list-style-type: none"> <li>Are the connections set up correctly? <a href="#">p.26</a> , <a href="#">p.27</a></li> <li>Are all the connected devices functioning properly?</li> <li>Is the mute function on? <a href="#">p.32</a></li> <li>Is the volume setting minimized? <a href="#">p.29</a></li> </ul>
<b>Picture not displayed correctly</b>	<ul style="list-style-type: none"> <li>Is the input signal supported by the projector? <a href="#">p.49</a> , <a href="#">p.50</a></li> <li>Is something generating an abnormal video signal, for instance the video tape?</li> </ul>
<b>Picture blurred Part of picture out of focus</b>	<ul style="list-style-type: none"> <li>Is the lens dirty? <a href="#">p.45</a></li> <li>Is the lens focus adjusted optimally? <a href="#">p.30</a></li> <li>Is the projection distance within the projector's supported range? <a href="#">p.25</a></li> <li>Is the projector's screen placement angle tilted too far? <a href="#">p.25</a></li> <li>Are the sharpness or sampling phase adjustments off?</li> </ul>
<b>Colors too light Bad shading</b>	<ul style="list-style-type: none"> <li>Are the color or tint adjustments off? <a href="#">p.34</a></li> <li>Is the screen dirty?</li> <li>Is the lamp nearing the end of its service life? <a href="#">p.48</a></li> </ul>
<b>Image is dark</b>	<ul style="list-style-type: none"> <li>Are the brightness or contrast adjustments off?</li> <li>Is the lamp nearing the end of its service life?</li> </ul>
<b>Remote control doesn't work</b>	<ul style="list-style-type: none"> <li>Is the remote control ON/OFF switch set off?</li> <li>Are the remote control's batteries exhausted?</li> <li>Are the batteries inserted into the remote control correctly? <a href="#">p.21</a></li> <li>Is the remote control being used within the effective range? <a href="#">p.21</a></li> <li>Are there any obstructions between the remote control and projector?</li> <li>Are there any fluorescent or other bright lights shining at the projector's infrared remote sensor?</li> </ul>
<b>USB device images aren't projected</b>	<ul style="list-style-type: none"> <li>Is the USB memory inserted correctly?</li> <li>Is a USB memory not supported by the projector inserted? <a href="#">p.49</a></li> <li>Are there any JPEG or movie files saved on the USB memory?</li> <li>Are the files too large or in an unsupported format for the projector?</li> </ul>

# Specifications

## ■ List of general specifications

Item		Specification
Consumption Power		230W
Weight		1.3kg
External Dimensions (including protruding parts)		210 x 76 x 170 (W x H x D, mm)
Cabinet material		Mg Alloy
Temperature		Operating temp: 5°C to 35°C (41°F to 95°F) Storage temp: -20°C to 60°C (-4°F to 140°F)
Relative humidity		80% max.
Altitude		Operating: 0 - 3000m (0 - 10,000 feet) Storage: 0-12,000m (0 - 40,000 feet)
Display device		1 DLP® chip
Picture elements		True 1024 x 768 resolution, 16.7M True colors
Lens		f=22-25.5mm
Light source		180W
Projection screen size		34-307 inches
Projection distance		1.6-12 m
Speaker		2W
Connection terminal	COMPUTER (Y/Pb/Pr) IN terminal	Mini D sub 15 pin Analog RGB / Y/PB/PR (dual use)
	VIDEO terminal	VIDEO: RCA Pin Jack
		AUDIO 3.5mm stereo mini-jack
		S-VIDEO
USB terminal		USB type A (for USB memory) USB type B (for service only)

### ■ Note

- This model complies with the above specifications.
- Designs and specifications are subject to change without notice.
- This model may not be compatible with features and/or specifications that may be added in the future.

### ■ Separately sold product

Replacement Lamp: Model TLPLP20.



## ■ List of supported signals (RGB signals)

This projector supports the following RGB signals. Note, however, that depending on the computer model, the screen may show flicker or streaking. Please adjust the projector if this happens.

Compatibility	Resolution	H-Sync [KHz]	V-Sync [Hz]
VGA	640 x 480	31.5	59.9
		37.9	72.8
		37.5	75.0
		43.3	85.0
SVGA	800 x 600	35.2	56.3
		37.9	60.3
		48.1	72.2
		46.9	75.0
		53.7	85.1
XGA	1024 x 768	48.4	60.0
		56.5	75.0
		60.0	75.0
		68.7	85.0
SXGA	1152 x 864	64.0	70.0
		67.5	75.0
	1280 x 960	60.0	60.0
		75.0	75.0
	1280 x 1024	64.0	60.0
	WXGA	1280 x 768	47.8
60.3			74.9
68.6			84.8
1280 x 800		49.7	59.8
		62.8	74.9

### ■ Note

- Signals whose resolution exceeds the native resolution (1024 x 768 pixels) will be compressed. For this reason, some information may be lost, or image quality may be affected.

## Specifications (Continued)

---

### ■ List of supported signals (Video, S-Video signals)

Signal	Horizontal Frequency (kHz)	Vertical Frequency (Hz)
480i	15.8 kHz	60 Hz
480p	31.5 kHz	60 Hz
576i	15.6 kHz	50 Hz
576p	31.3 kHz	50 Hz
720p	45.0 kHz	60 Hz
720p	37.5 kHz	50 Hz
1080i	33.8 kHz	60 Hz
1080i	28.1 kHz	50 Hz

## ■ Pin assignment of COMPUTER IN terminals

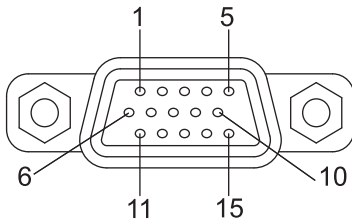

Mini D-sub 15 pin connector

Pin No.	Spec
1	RED
2	GREEN
3	BLUE
4	NC
5	GND
6	GND
7	GND
8	GND
9	VCC 5V
10	NC
11	NC
12	SDA
13	HSYNC
14	VSYNC
15	SCL

## ■ Pin assignment of S-VIDEO terminals

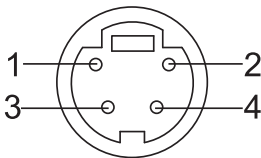

Pin No.	Spec
1	GND
2	GND
3	SVID_LUM
4	SVID_CHR

**TOSHIBA CORPORATION**