

SANYO

Multimedia Projector

MODEL PLV-Z4

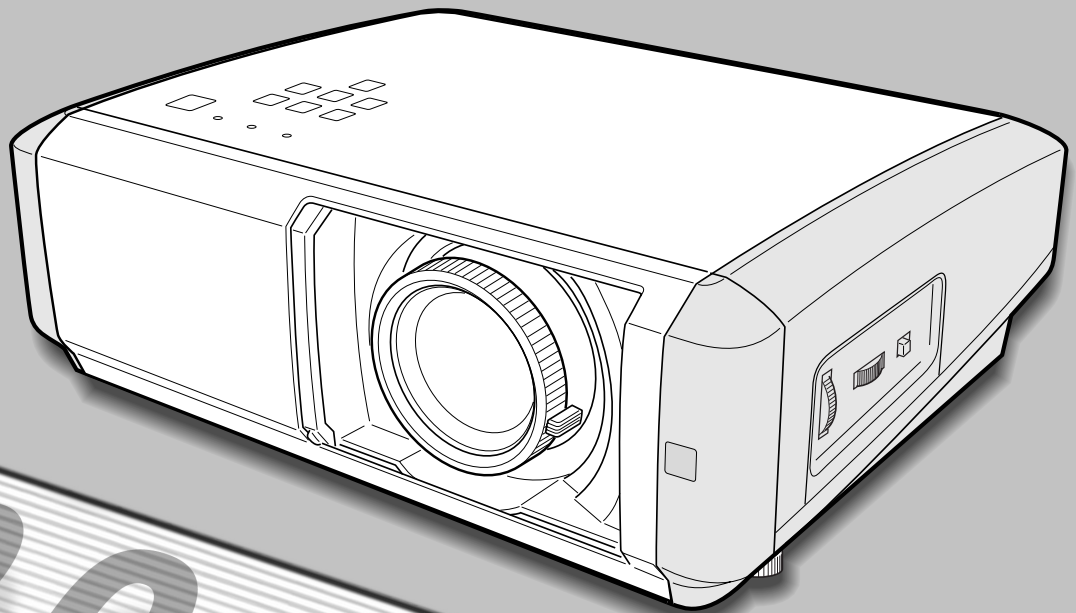

PROJECTOR

Owner's Manual

Features and Design

This Multimedia Projector is designed with the most advanced technology for portability, durability, and ease of use. This projector utilizes built-in multimedia features, a palette of 1.07 billion colors, and matrix liquid crystal display (LCD) technology.

◆ **Short Throw & Wide-Range Zoom Lens**

This projector is equipped with 2x Short Throw & Wide-Range Zoom Lens capable of throwing a 100" diagonal image from a distance of 9.8' (3.0 m) to 20.0' (6.1 m).

◆ **Lens Shift**

The Lens Shift function provides the projector greater installation flexibility. You can use the projector at desired places without a distorted image. (See page 15.)

◆ **Color Management Function**

The Color management function allows you to adjust the details of picture colors to suit your preference and surroundings. (See pages 30 ~ 31.)

◆ **Twin Iris Function**

The total control of the Lens iris and Lamp iris enhances the contrast and the depth of the projected image.

◆ **Compatibility**

The projector widely accepts various video and computer input signals including; Computers, 6 Color systems (PAL, SECAM, NTSC, NTSC4.43, PAL-M, PAL-N), Component video, S-video, RGB scart and HDMI.

◆ **Simple Computer System Setting**

The projector has the Multi-scan system to conform to almost all computer output signals instantly. (See page 26.)

◆ **16 : 9 Wide Screen**

The projector is equipped with LCD panels (1280 x 720 resolution) of 16 : 9 aspect ratio so that you can project the image from component video signals such as DVD players and high definition TV devices in full screen.

◆ **Interlace-Progressive Conversion**

High-quality picture is available with this technology which converts an interlaced signal into a progressively-scanned one. (See page 29.)

◆ **Automatic Slide Shutter**

The automatic slide shutter protects the lens from dust and scratches. It opens and closes automatically as you press the POWER ON-OFF button.

◆ **Wide Selection of Image Levels**

You can select an ideal image level suitable for the surroundings or for your desired picture quality (see page 27). Four (4) different kinds of images of your choice can also be stored. (See pages 28 ~ 31.)

◆ **Power Management**

The Power management function reduces power consumption and maintains the lamp life. (See page 37.)

◆ **Logo Function**

The Logo function allows you to customize the screen logo (see page 37). You can capture an image for the screen logo and choose a logo between provided and captured.

◆ **Lamp Control**

The brightness of the projection lamp can be selected. (See pages 22 and 29.)

◆ **Multi-language Menu Display**

Operation menu is available in 16 languages; English, German, French, Italian, Spanish, Portuguese, Dutch, Swedish, Finnish, Polish, Hungarian, Romanian, Russian, Chinese, Korean, or Japanese. (See page 35.)

◆ **Selectable Setting Position**

The Mounting function provides a proper image position (up/down and left/right) depending on the setting position of the projector such as ceiling mounting or wall-hanging. (See page 36.)

◆ **High Definition Multimedia Interface**

The projector is equipped with a HDMI terminal for connecting the HDMI output from external video equipment. A simple connection with digital equipment is offered through this terminal .

✓ **Note:**

- The On-Screen Menu and figures in this manual may differ slightly from the product.
- The contents of this manual are subject to change without notice.

Table of Contents

Features and Design	2	Input	24
Table of Contents	3	Input Source and System Selection	24
To the Owner	4	Image	27
Safety Instructions	5	Image Level Selection	27
Air Circulation	6	Image Adjustment	28
Installing the Projector in Proper Position	6	Image Level Adjustment	28
Moving the Projector	6	Picture Adjustment	32
Compliance	7	Picture Position and Screen Adjustment	32
Part Names and Functions	8	Screen	33
Front	8	Screen Size Adjustment	33
Back	8	Setting	35
Bottom	8	Setting	35
Rear Terminal	9	Information	40
Top Control	10	Input Source Information Display	40
Remote Control	11	Maintenance and Cleaning	41
Remote Control Operating Range	12	Warning Indicator	41
Remote Control Battery Installation	12	Cleaning the RGB panels	42
Installation	13	Cleaning the Air Filters	44
Positioning the Projector	13	Cleaning the Projection Lens	45
Adjustable Feet	13	Cleaning the Projector Cabinet	45
Connecting the AC Power Cord	14	Lamp Replacement	46
Moving the Lens	15	Lamp Replacement Counter	47
Connecting to Video Equipment (Video, S-Video)	16	Appendix	48
Connecting to Video Equipment (Component)	16	Troubleshooting	48
Connecting to Video Equipment (HDMI, RGB Scart)	17	Indicators and Projector Condition	49
Connecting to a Computer	17	Menu Tree	50
Basic Operation	18	Compatible Computer Specifications	52
Turning On the Projector	18	Technical Specifications	53
Turning Off the Projector	19	Dimensions	54
How to Operate the On-Screen Menu	20	Configurations of Terminals	55
Menu and its Functions	21	Optional Parts	55
Zoom and Focus Adjustment	22		
Remote Control Operation	22		

TRADEMARKS

- Apple, Macintosh, and PowerBook are trademarks or registered trademarks of Apple Computer, Inc.
- IBM, VGA, XGA, and PS/2 are trademarks or registered trademarks of International Business Machines, Inc.
- Windows and PowerPoint are registered trademarks of Microsoft Corporation.
- Each name of corporations or products in this owner's manual is either a trademark or a registered trademark of its respective corporation.





To the Owner

Before operating this projector, read this manual thoroughly and operate the projector properly.



This projector provides many convenient features and functions. Operating the projector properly enables you to manage those features and maintain it in better condition for a considerable time.

Improper operation may result in not only shortening the product life, but also malfunctions, fire hazard, or other accidents.

If your projector seems to operate improperly, read this manual again, check operations and cable connections and try the solutions in the "Troubleshooting" section in the end of this booklet. If the problem still persists, contact the dealer where you purchased the projector or the service center.

 CAUTION RISK OF ELECTRIC SHOCK DO NOT OPEN 
CAUTION : TO REDUCE THE RISK OF ELECTRIC SHOCK, DO NOT REMOVE COVER (OR BACK). NO USER-SERVICEABLE PARTS INSIDE EXCEPT LAMP REPLACEMENT. REFER SERVICING TO QUALIFIED SERVICE PERSONNEL.
 THIS SYMBOL INDICATES THAT DANGEROUS VOLTAGE CONSTITUTING A RISK OF ELECTRIC SHOCK IS PRESENT WITHIN THIS UNIT.
 THIS SYMBOL INDICATES THAT THERE ARE IMPORTANT OPERATING AND MAINTENANCE INSTRUCTIONS IN THE OWNER'S MANUAL WITH THIS UNIT.

NOTE: This symbol mark and recycle system are applied only to EU countries and not applied to the countries in the other area of the world.

	Your SANYO product is designed and manufactured with high quality materials and components which can be recycled and reused.
	This symbol means that electrical and electronic equipment, at their end-of-life, should be disposed of separately from your household waste.

Please dispose of this equipment at your local community waste collection/recycling centre.
In the European Union there are separate collection systems for used electrical and electronic products.
Please help us to conserve the environment we live in!



Safety Precaution

WARNING : TO REDUCE THE RISK OF FIRE OR ELECTRIC SHOCK, DO NOT EXPOSE THIS APPLIANCE TO RAIN OR MOISTURE.

- This projector produces intense light from the projection lens. Do not stare directly into the lens as much as possible. Eye damage could result. Be especially careful that children do not stare directly into the beam.
- Install the projector in a proper position. If not, it may result in a fire hazard.
- Provide appropriate space on the top, sides and rear of the projector cabinet for allowing air circulation and cooling the projector. Minimum clearances must be maintained. If the projector is to be built into a compartment or similarly enclosed, the minimum distances must be maintained. Do not cover the ventilation slot on the projector. Heat build-up can reduce the service life of your projector, and can also be dangerous.

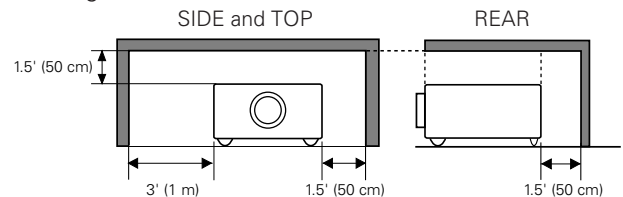

- If the projector is not to be used for an extended time, unplug the projector from the power outlet.



CAUTION ON HANGING FROM THE CEILING

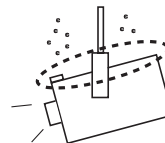

When hanging the projector from the ceiling, clean the air intake vents, air filters, and top of the projector periodically with a vacuum cleaner. If you leave the projector without cleaning for a long time, the dust will block the operation of the cooling function, and it may cause a breakdown or a disaster.

DO NOT SET THE PROJECTOR IN GREASY, WET, OR SMOKY CONDITIONS SUCH AS IN A KITCHEN TO PREVENT A BREAKDOWN OR A DISASTER. IF THE PROJECTOR COMES IN CONTACT WITH OIL OR CHEMICALS, IT MAY BECOME DETERIORATED.

CAUTION

Not for use in a computer room as defined in the Standard for the Protection of Electronic Computer/Data Processing Equipment, ANSI/NFPA 75.

Ne peut être utilisé dans une salle d'ordinateurs telle que définie dans la norme ANSI/NFPA 75 Standard for Protection of Electronic Computer/Data Processing Equipment.

READ AND KEEP THIS OWNER'S MANUAL FOR LATER USE.

Safety Instructions

All the safety and operating instructions should be read before the product is operated.

Read all of the instructions given here and retain them for later use. Unplug this projector from AC power supply before cleaning. Do not use liquid or aerosol cleaners. Use a damp cloth for cleaning.

Follow all warnings and instructions marked on the projector.

For added protection to the projector during lightning storm, or when it is left unattended and unused for long periods of time, unplug it from the wall outlet. This will prevent damage due to lightning and power line surges.

Do not expose this unit to rain or use near water... for example, in a wet basement, near a swimming pool, etc...

Do not use attachments not recommended by the manufacturer as they may cause hazards.

Do not place this projector on an unstable cart, stand, or table. The projector may fall, causing serious injury to a child or adult, and serious damage to the projector. Use only with a cart or stand recommended by the manufacturer, or sold with the projector. Wall or shelf mounting should follow the manufacturer's instructions, and should use a mounting kit approved by the manufacturers.

An appliance and cart combination should be moved with care. Quick stops, excessive force, and uneven surfaces may cause the appliance and cart combination to overturn.



Slots and openings in the back and bottom of the cabinet are provided for ventilation, to insure reliable operation of the equipment and to protect it from overheating.

The openings should never be covered with cloth or other materials, and the bottom opening should not be blocked by placing the projector on a bed, sofa, rug, or other similar surface. This projector should never be placed near or over a radiator or heat register.

This projector should not be placed in a built-in installation such as a book case unless proper ventilation is provided.

Never push objects of any kind into this projector through cabinet slots as they may touch dangerous voltage points or short out parts that could result in a fire or electric shock. Never spill liquid of any kind on the projector.

Do not install the projector near the ventilation duct of air-conditioning equipment.

This projector should be operated only from the type of power source indicated on the marking label. If you are not sure of the type of power supplied, consult your authorized dealer or local power company.

Do not overload wall outlets and extension cords as this can result in fire or electric shock. Do not allow anything to rest on the power cord. Do not locate this projector where the cord may be damaged by persons walking on it.

Do not attempt to service this projector yourself as opening or removing covers may expose you to dangerous voltage or other hazards. Refer all servicing to qualified service personnel.

Unplug this projector from wall outlet and refer servicing to qualified service personnel under the following conditions:

- a. When the power cord or plug is damaged or frayed.
- b. If liquid has been spilled into the projector.
- c. If the projector has been exposed to rain or water.
- d. If the projector does not operate normally by following the operating instructions. Adjust only those controls that are covered by the operating instructions as improper adjustment of other controls may result in damage and will often require extensive work by a qualified technician to restore the projector to normal operation.
- e. If the projector has been dropped or the cabinet has been damaged.
- f. When the projector exhibits a distinct change in performance, this indicates a need for service.

When replacement parts are required, be sure the service technician has used replacement parts specified by the manufacturer that have the same characteristics as the original part. Unauthorized substitutions may result in fire, electric shock, or injury to persons.

Upon completion of any service or repairs to this projector, ask the service technician to perform routine safety checks to determine that the projector is in safe operating condition.

	Voor de klanten in Nederland
	Bij dit produkt zijn batterijen geleverd. Wanneer deze leeg zijn, moet u ze niet weggooien maar inleveren als KCA.

Safety Instructions

Air Circulation

Openings in the cabinet are provided for ventilation and to ensure reliable operation of the product and to protect it from overheating, and these openings must not be blocked or covered.



CAUTION

Hot air is exhausted from the exhaust vent. When using or installing the projector, the following precautions should be taken.

- Do not put any flammable objects or spray can near the projector. Hot air is exhausted from the ventilation holes.
- Keep the exhaust vent at least 3' (1 m) away from any objects.
- Do not touch the peripheral part of the exhaust vent, especially the screws and metallic part. This area will become hot while the projector is being used.
- Do not put anything on the cabinet. Objects put on the cabinet will not only get damaged but also cause a fire hazard by heat.

Cooling fans are provided to cool down the projector. The fans' running speed is changed according to the temperature inside the projector.

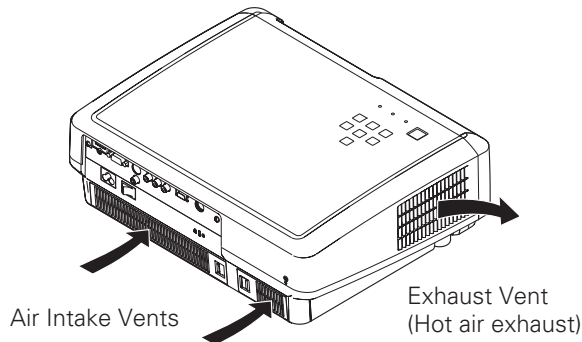

Installing the Projector in Proper Position

Install the projector properly. Improper Installation may reduce the lamp lifetime and cause a fire hazard.

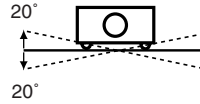

Do not tilt the projector more than 20 degrees from side to side.



NO DOWNWARD

Do not point the projector down to project an image.



NO SIDEWARD

Do not put the projector on either side to project an image.

Moving the Projector

When moving the projector, make sure that the automatic slide shutter is closed and retract the adjustable feet to prevent damage to the lens and cabinet.

When the projector is not in use for an extended period, put it into a suitable case to protect a projector.

Care must be taken when handling the projector; do not drop, bump, subject it to strong forces or put other things on the cabinet.



CAUTION IN CARRYING OR TRANSPORTING THE PROJECTOR

- Do not drop or bump the projector, otherwise damages or malfunctions may result.
- When carrying the projector, use a suitable carrying case.
- Do not transport the projector by using a courier or transport service in an unsuitable transport case. This may cause damage to the projector. To transport the projector through a courier or transport service, consult your dealer for more information.
- Do not put the projector in a case before the projector is cooled enough.

Federal Communication Commission Notice

Note: This equipment has been tested and found to comply with the limits for a Class B digital device, pursuant to part 15 of the FCC Rules. These limits are designed to provide reasonable protection against harmful interference in a residential installation. This equipment generates, uses and can radiate radio frequency energy and, if not installed and used in accordance with the instructions, may cause harmful interference to radio communications. However, there is no guarantee that interference will not occur in a particular installation. If this equipment does cause harmful interference to radio or television reception, which can be determined by turning the equipment off and on, the user is encouraged to try to correct the interference by one or more of the following measures :

- Reorient or relocate the receiving antenna.
- Increase the separation between the equipment and receiver.
- Connect the equipment into an outlet on a circuit different from that to which the receiver is connected.
- Consult the dealer or an experienced radio/TV technician for help.

Use of shielded cable is required to comply with class B limits in Subpart B of Part 15 of FCC Rules.

Do not make any changes or modifications to the equipment unless otherwise specified in the instructions. If such changes or modifications should be made, you could be required to stop operation of the equipment.

Model Number : PLV-Z4
Trade Name : Sanyo
Responsible party : SANYO FISHER COMPANY
Address : 21605 Plummer Street, Chatsworth, California 91311
Telephone No. : (818)998-7322

AC POWER CORD REQUIREMENT

The AC Power Cord supplied with this projector meets the requirement for use in the country you purchased it.

AC Power Cord for the United States and Canada:

AC Power Cord used in the United States and Canada is listed by the Underwriters Laboratories (UL) and certified by the Canadian Standard Association (CSA).

AC Power Cord has a grounding-type AC line plug. This is a safety feature to be sure that the plug will fit into the power outlet. Do not try to defeat this safety feature. Should you be unable to insert the plug into the outlet, contact your electrician.

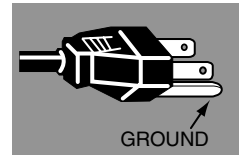

AC Power Cord for the United Kingdom:

This cord is already fitted with a moulded plug incorporating a fuse, the value of which is indicated on the pin face of the plug. Should the fuse need to be replaced, an ASTA approved BS 1362 fuse must be used of the same rating, marked thus \diamond . If the fuse cover is detachable, never use the plug with the cover omitted. If a replacement fuse cover is required, ensure it is of the same colour as that visible on the pin face of the plug (i.e. red or orange). Fuse covers are available from the Parts Department indicated in your User Instructions.

If the plug supplied is not suitable for your socket outlet, it should be cut off and destroyed.

The end of the flexible cord should be suitably prepared and the correct plug fitted. (See Over.)

WARNING: A PLUG WITH BARED FLEXIBLE CORD IS HAZARDOUS IF ENGAGED IN A LIVE SOCKET OUTLET.

The Wires in this mains lead are coloured in accordance with the following code:

Green-and-yellow Earth
Blue Neutral
Brown Live

As the colours of the wires in the mains lead of this apparatus may not correspond with the coloured markings identifying the terminals in your plug proceed as follows:

The wire which is coloured green-and-yellow must be connected to the terminal in the plug which is marked by the letter E or by the safety earth symbol \perp or coloured green or green-and-yellow.

The wire which is coloured blue must be connected to the terminal which is marked with the letter N or coloured black.

The wire which is coloured brown must be connected to the terminal which is marked with the letter L or coloured red.

WARNING: THIS APPARATUS MUST BE EARTHED.

THE SOCKET-OUTLET SHOULD BE INSTALLED NEAR THE EQUIPMENT AND EASILY ACCESSIBLE.

Part Names and Functions

Front

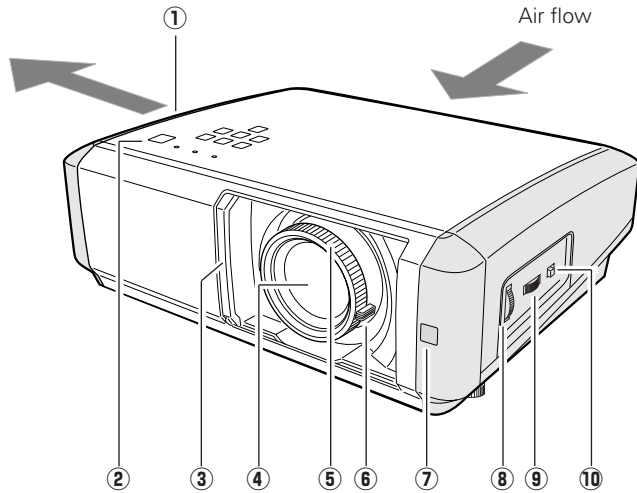

① Exhaust Vent



CAUTION

Hot air is exhausted from the exhaust vent. Do not put heat-sensitive objects near this side.

② Top Controls and Indicators

③ Automatic Slide Shutter

④ Projection Lens

⑤ Focus Ring

⑥ Zoom Lever

⑦ Infrared Remote Receiver

⑧ Vertical Lens Shift Ring (Up/Down)

⑨ Horizontal Lens Shift Ring (Left/Right)

⑩ Lens Shift Lock

Back

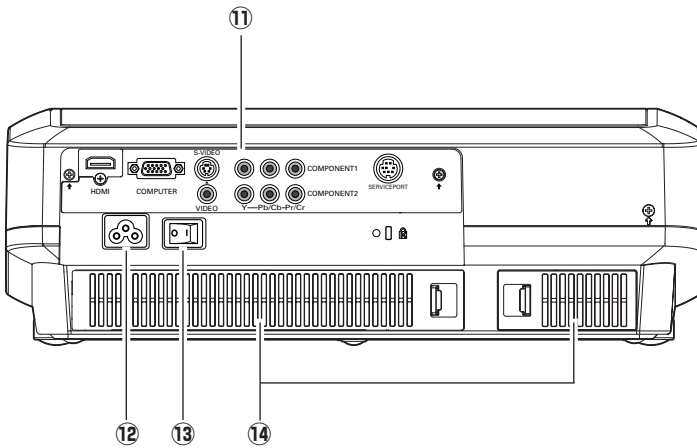

⑪ Terminals and Connectors

⑫ Power Cord Connector

⑬ Main On/Off Switch

⑭ Air Intake Vents/Air Filters

Bottom

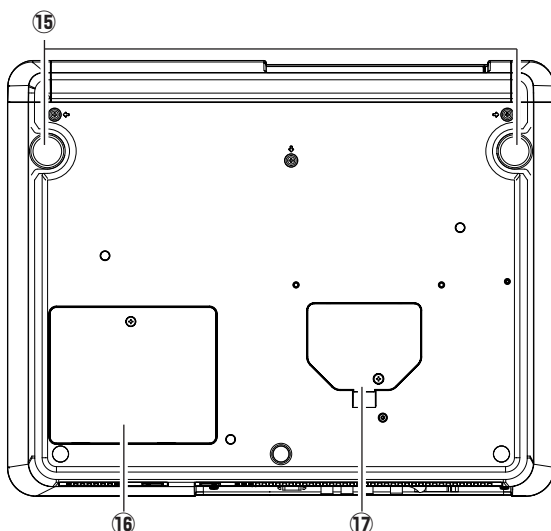

⑮ Adjustable Feet

⑯ Lamp Cover

⑰ RGB Panel Cleaning Hole Cover

Rear Terminal

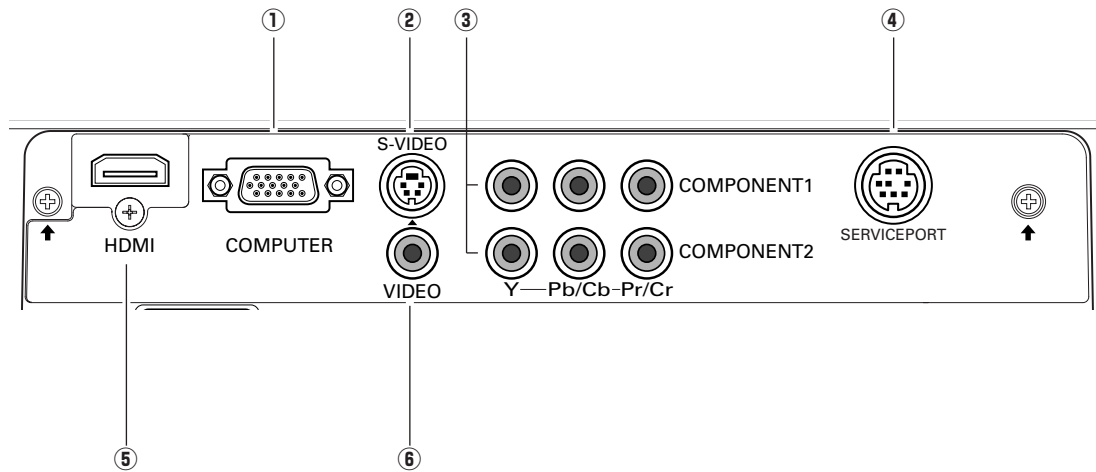

① COMPUTER

Connect the computer output, or RGB Scart 21-pin video output to this connector (p.17).

② S-VIDEO

Connect the S-Video output from video equipment to this jack (p.16).

③ COMPONENT 1 or 2

Connect the component video output to these jacks (p.16).

④ SERVICE PORT

This jack is used to service the projector.

⑤ HDMI

Connect the HDMI output from video equipment to this terminal (p.17).

⑥ VIDEO

Connect the composite video output from video equipment to this jack (p.16).

Top Control

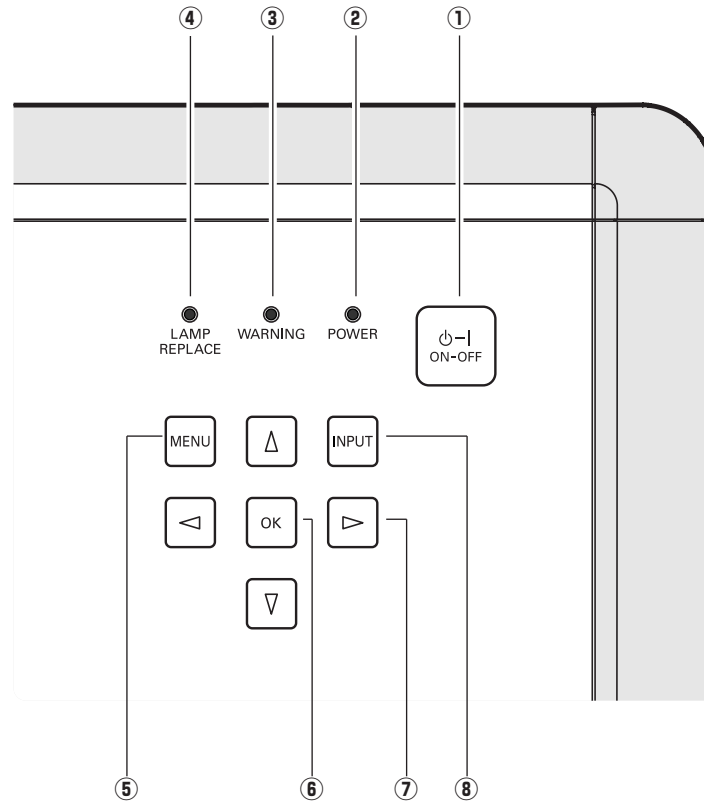

① POWER ON-OFF button

Turn the projector on or off (p.18, 19).

② POWER indicator

- Lights red while the projector is in stand-by mode.
 - Lights green during operations.
 - Blinks red during the cooling-off period.
 - Blinks green in the Power management mode (p.37).
- When the automatic slide shutter is closed during operations, it blinks orange (p.49).

③ WARNING indicator

Emits a red light when the projector detects an abnormal condition. It also blinks red when the internal temperature of the projector exceeds the operating range (p.41, 49).

④ LAMP REPLACE indicator

Emits a yellow light when the life of the projection lamp draws to an end (p.46, 49).

⑤ MENU button

Open or close the On-Screen Menu (p.20).

⑥ OK button

Execute the item selected or use it to access the sub-menu items (p.20).

⑦ POINT ▲▼◀▶ buttons

Select an item or adjust the setting values in the On-Screen Menu, or use them to pan the image in the Normal through mode (p.34).

⑧ INPUT button

Select an input source (p.24).

Remote Control

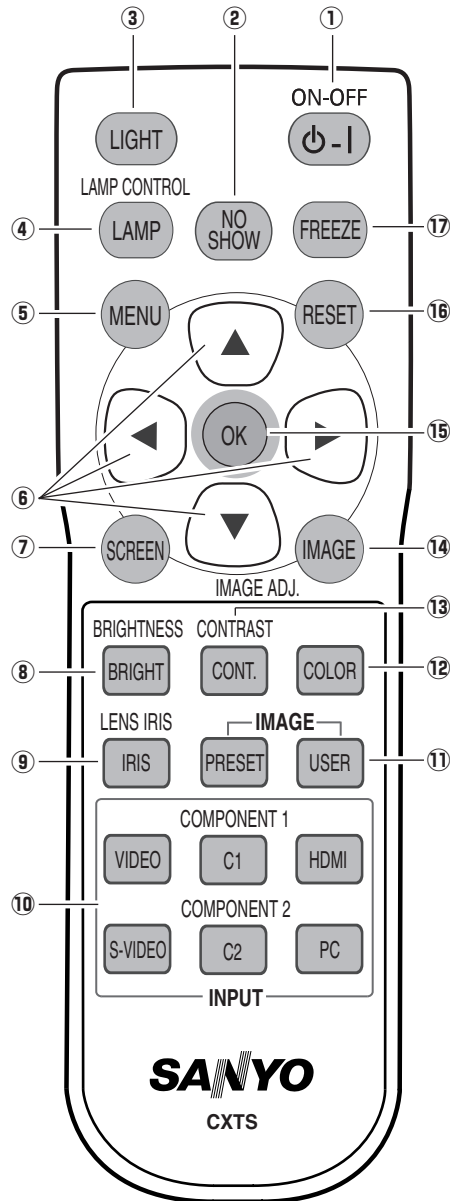

- ① **POWER ON-OFF button**
Turn the projector on or off (p.18, 19).
- ② **NO SHOW button**
Temporarily turn off the image on the screen (p.23).
- ③ **LIGHT button**
Light up the remote control buttons for about 10 seconds (p.22).
- ④ **LAMP CONTROL button**
Select a lamp mode (p.22, 29).
- ⑤ **MENU button**
Open or close the On-Screen Menu (p.20).
- ⑥ **POINT ▲▼◀▶ buttons**
Select an item or adjust the setting values in the On-Screen Menu, or use them to pan the image in the Normal through mode (p.34).
- ⑦ **SCREEN button**
Select a screen size (p.23, 33).
- ⑧ **BRIGHTNESS button**
Adjust the brightness of a projected image (p.23, 28).
- ⑨ **LENS IRIS button**
Adjust the lens iris (p.23, 29).
- ⑩ **INPUT buttons**
Select an input source (p.24).
- ⑪ **IMAGE buttons**
Select an image level (p.23, 27).
- ⑫ **COLOR button**
Adjust the color intensity of a projected image (p.23, 28).
- ⑬ **CONTRAST button**
Adjust the contrast of a projected image (p.23, 28).
- ⑭ **IMAGE ADJ. button**
Display the Image adj. Menu items one at a time and directly adjust its image level (p.23, 28).
- ⑮ **OK button**
Execute the selected item or access the sub-menu items (p.20).
- ⑯ **RESET button**
Reset to the previous figure.
This function is limited to when selecting the Image Adjustment (p.28 ~ 31), Picture Adjustment (p.32) and the Keystone function in the Setting (p.35).
- ⑰ **FREEZE button**
Freeze the picture on the screen (p.22).

Remote Control Operating Range

Point the remote control toward the projector (Infrared Remote Receiver) when pressing any buttons. Maximum operating range for the remote control is about 16.4' (5 m) and 60 degrees in front of the projector.

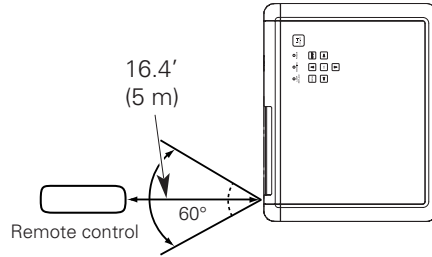

Remote Control Battery Installation

1 Open the battery compartment lid.

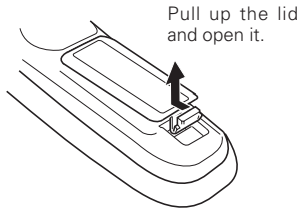

2 Install new batteries into the compartment.

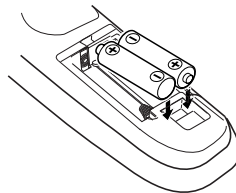

Two AA size batteries
For correct polarity (+ and -), be sure battery terminals are in contact with pins in the compartment.

3 Replace the compartment lid.

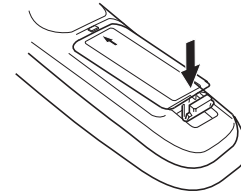

* When the batteries of the remote control are replaced, the remote control code automatically returns to the initial code (Code 1) (p.38).



To insure safe operation, please observe the following precautions:

- Use two (2) AA or LR06 type alkaline batteries.
- Always replace batteries in sets.
- Do not use a new battery with a used battery.
- Avoid contact with water or liquid.
- Do not expose the remote control to moisture or heat.
- Do not drop the remote control.
- If the battery has leaked on the remote control, carefully wipe the case clean and install new batteries.
- Risk of explosion if battery is replaced by an incorrect type.
- Dispose of used batteries according to the instructions.

Installation

Positioning the Projector

This projector is designed to project on a flat projection surface having a focus range of 3.9' (1.2 m) to 30.2' (9.2 m) at maximum zoom and 7.9' (2.4 m) to 30.2' (9.2 m) at minimum zoom. Refer to the figure and table below for the screen size and distance between the projector and a screen.

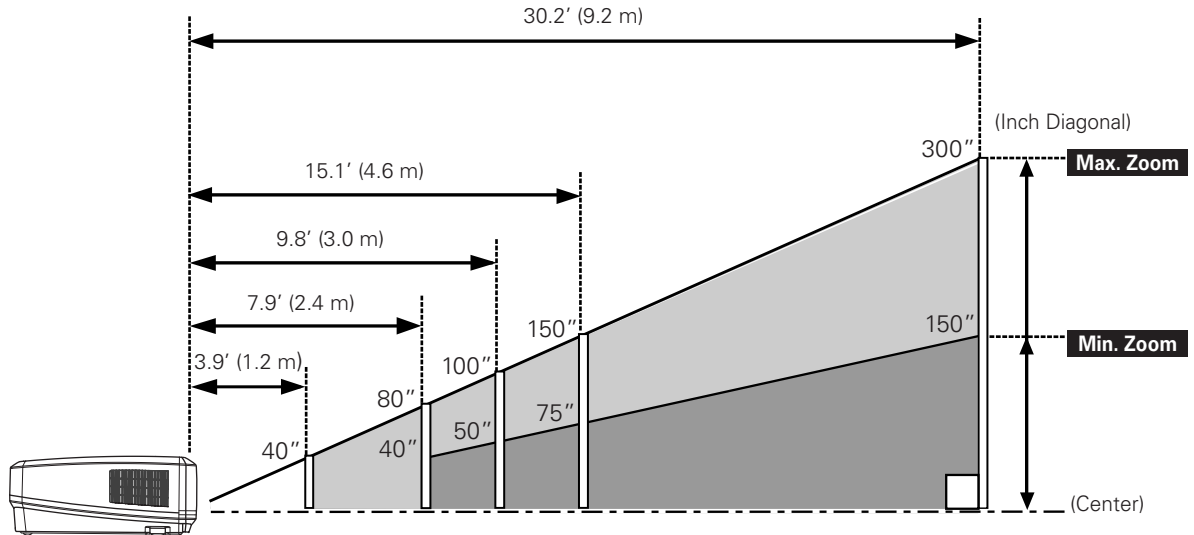

Screen Size (W x H) mm	40"	80"	100"	150"	300"
16 : 9 aspect ratio	886 x 498	1771 x 996	2214 x 1245	3321 x 1868	6641 x 3736
Zoom (min)	7.9' (2.4m)	16.0' (4.9 m)	20.0' (6.1 m)	30.2' (9.2 m)	—
Zoom (max)	3.9' (1.2m)	7.9' (2.4 m)	9.8' (3.0m)	15.1' (4.6 m)	30.2' (9.2 m)

✓ Note:

- The brightness in the room has a great influence on picture quality. It is recommended to limit ambient lighting in order to obtain the best image.
- All measurements are approximate and may vary from the actual sizes.

Adjustable Feet

Projection angle can be adjusted up to 7.7 degrees with the adjustable feet.

- 1 Rotate the adjustable feet and tilt the projector to the proper height; to raise the feet, rotate the both feet clockwise.
 - 2 To lower or to retract the adjustable feet, rotate the both feet counterclockwise.
- Keystone distortion of the projected image can be corrected by menu operation (p.35).

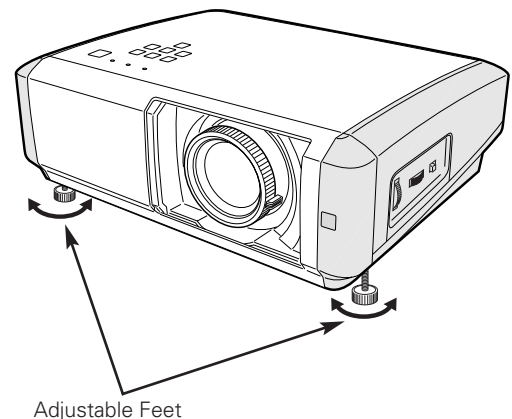

Connecting the AC Power Cord

This projector uses nominal input voltages of 100-120V or 200-240V AC and it automatically selects a correct input voltage. It is designed to work with the single-phase power systems having a grounded neutral conductor. To reduce the risk of electrical shock, do not plug into any other type of power system.

If you are not sure of the type of power being supplied, consult your authorized dealer or service station.

Connect the projector with all peripheral equipment before turning on the projector. (See pages 16 ~ 17 for connection.)



CAUTION

For safety, unplug the AC power cord when the projector is not in use.

When the projector is connected to an outlet with the AC power cord and the Main On/Off switch is on, it is in stand-by mode and consumes a little electric power. Turn the Main On/Off switch off when the projector is not in use.

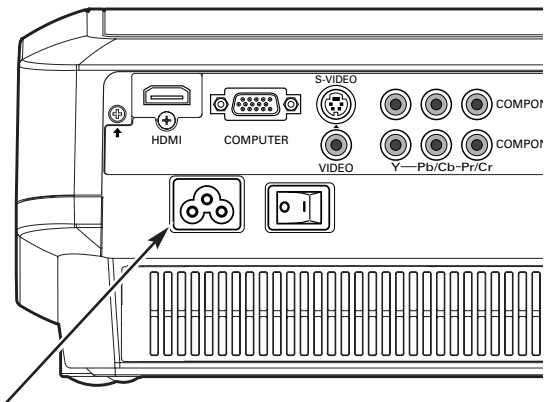

Connect the AC power cord (supplied) to the projector.

The AC outlet must be near this equipment and must be easily accessible.

NOTE ON THE POWER CORD

AC power cord must meet the requirements of the country where you use the projector. Confirm the AC plug type with the chart below and a proper AC power cord must be used. If the supplied AC power cord does not match your AC outlet, contact your sales dealer.

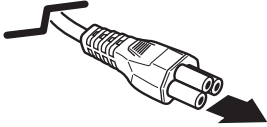
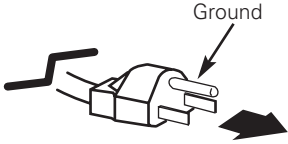
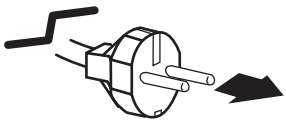
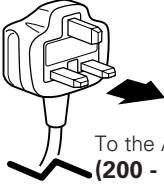
Projector side	AC outlet side		
 <p data-bbox="240 1373 415 1444">To power cord connector on your projector.</p>	<p data-bbox="493 1171 797 1201">For the U.S.A. and Canada</p>  <p data-bbox="623 1381 789 1432">To the AC outlet. (120 V AC)</p>	<p data-bbox="829 1171 1127 1201">For Continental Europe</p>  <p data-bbox="948 1398 1130 1449">To the AC outlet. (200 - 240 V AC)</p>	<p data-bbox="1230 1171 1382 1201">For the U.K.</p>  <p data-bbox="1276 1381 1458 1432">To the AC outlet. (200 - 240 V AC)</p>

Moving the Lens

The projection lens can be moved up and down or left and right manually with the Lens Shift Rings, enabling you to adjust the position of a projected image. After adjusting the position, lock the lens with the Lens Shift Lock.

Move the projection lens to the left or right with the Horizontal Lens Shift Ring.

Move the projection lens up or down with the Vertical Lens Shift Ring.

Horizontal Lens Shift Ring (Left/Right)

Lens Shift Lock

Vertical Lens Shift Ring (Up/Down)

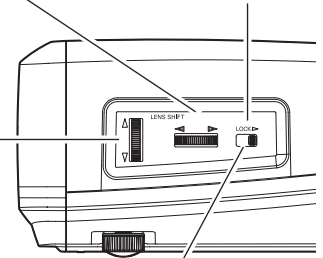

Before using the Lens Shift Rings, make sure that this lock is released.

Horizontal Lens Shift (Left/Right)

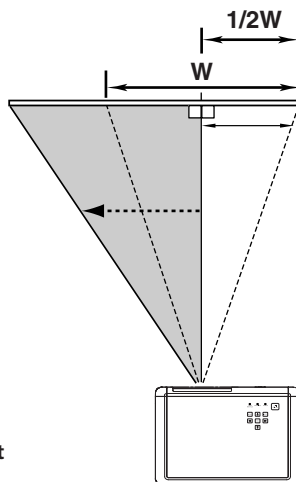

leftmost

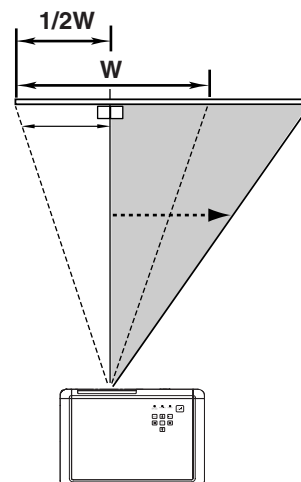

rightmost

Vertical Lens Shift (Up/Down)

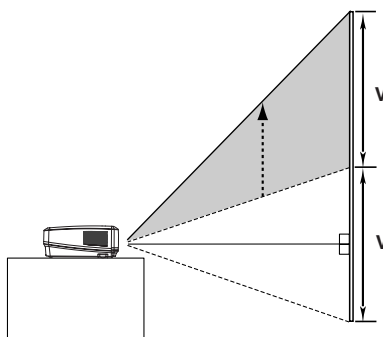

uppermost

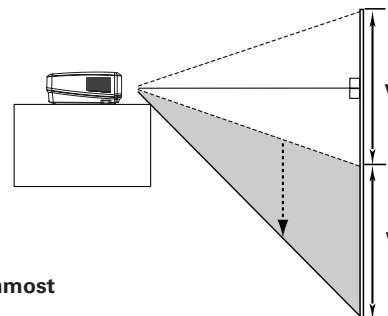

downmost

✓ **Note:**

- The best image is generally obtained at the central axis of the lens shift.
- With maximum lens shift in each direction, image distortion may be observed at the edge of the screen.
- With the maximum horizontal lens shift, the maximum vertical lens shift cannot be obtained, and vice versa.
- The Lens Shift Rings are locked at the factory. Make sure that the Lens Shift Lock is released before using the Lens Shift Rings.

Installation

This projector can be connected up to six equipment at one time. See the figures below for the connections.

Connecting to Video Equipment (Video, S-Video)

Video, S-video

Use the supplied video cable or a S-video cable (commercially available).

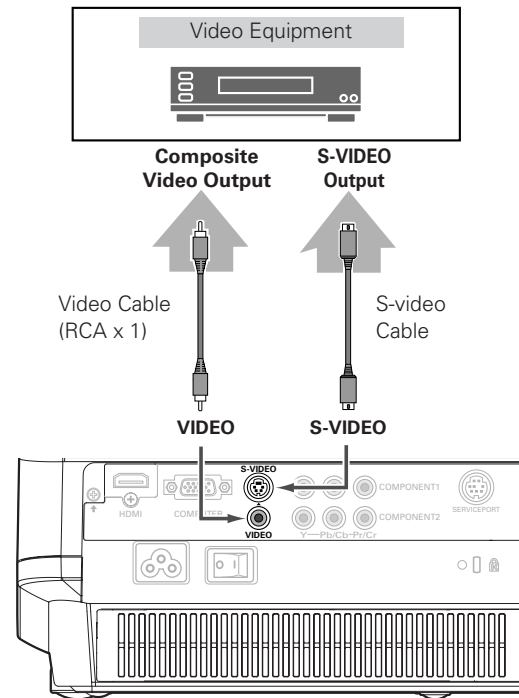

Connecting to Video Equipment (Component)

Component

Use a component cable (optional).

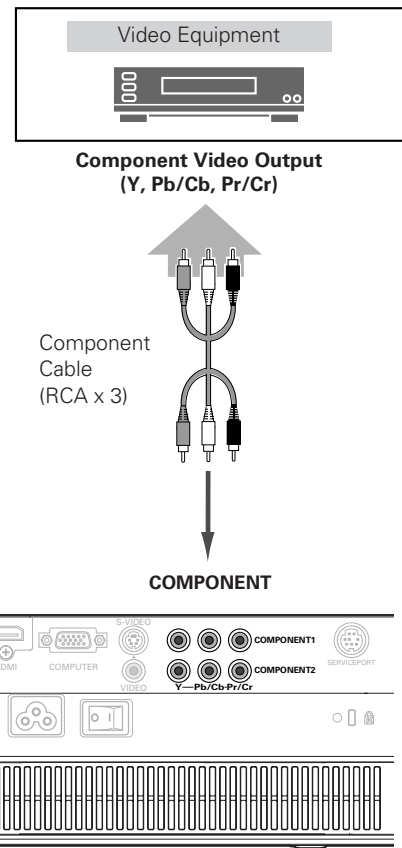

✓ Note:

- See page 55 for ordering optional cables.
- For the connection between HDTV equipment and projector's COMPONENT 1/2 terminals, horizontal line noise may be noted only occasionally. In this case, adjust the value of Fine sync on page 32. The factory default value of Fine sync is "10". The setting can be adjusted between 0 to +31.



Note:

When connecting cables, the power cords of both the projector and external equipment should be disconnected from the AC outlet.

Connecting to Video Equipment (HDMI, RGB Scart)

HDMI

Use a HDMI cable (optional) for HDMI output.

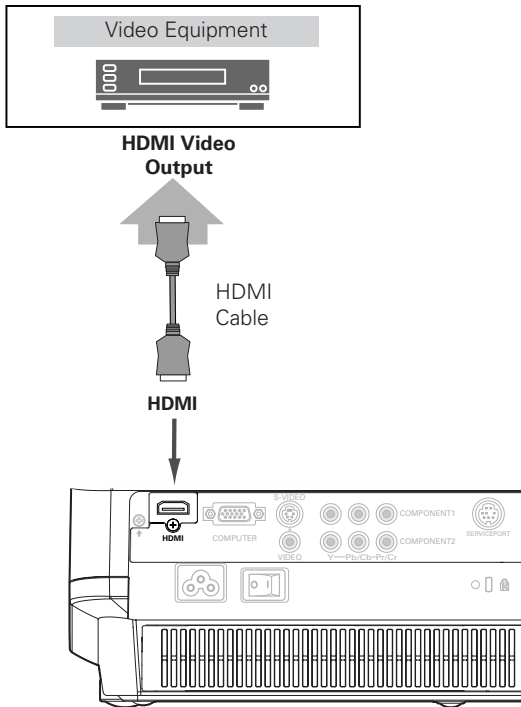

RGB Scart

Use a Scart-VGA cable (optional).

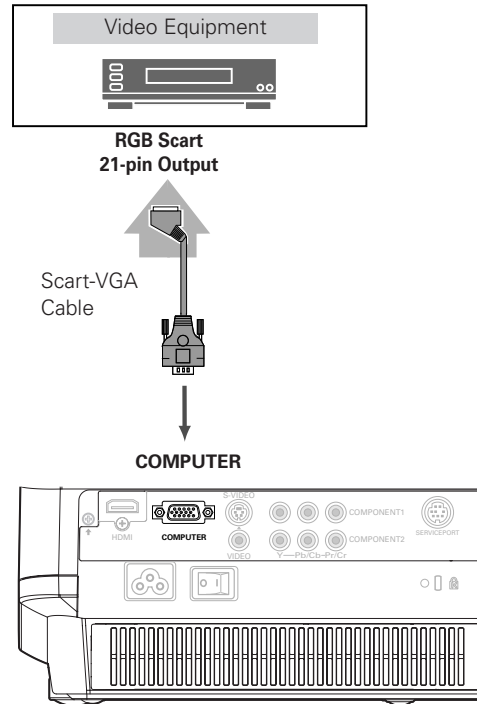

Connecting to a Computer

Computer (Analog)

Use a VGA cable (commercially available) or a DVI-VGA cable (commercially available).

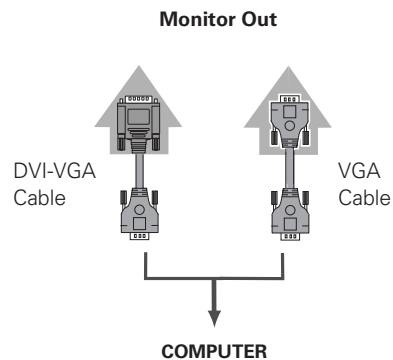
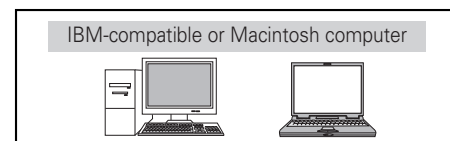

✓ Note:

• See page 55 for ordering optional cables.



Note:

When connecting cables, the power cords of both the projector and external equipment should be disconnected from the AC outlet.

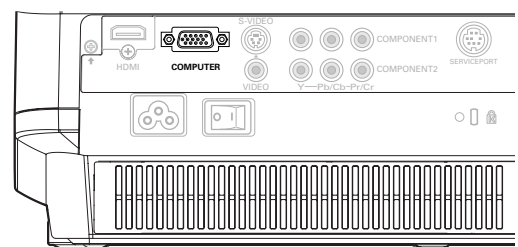

Basic Operation

Turning On the Projector

- 1 Complete peripheral connections (with a computer, VCR, etc.) before turning on the projector.
- 2 Connect the projector's AC power cord into an AC outlet and turn the Main On/Off switch on. The POWER indicator lights red.
- 3 Press the POWER ON-OFF button on the top control or on the remote control. The POWER indicator turns green and the cooling fans start to operate. The automatic slide shutter opens, and then a preparation display appears on the screen and the countdown will start.
- 4 After the countdown, the input source that was selected the last time will appear on the screen.

✓ **Note:**

- If the automatic slide shutter is half-open, projector will not be turned on and the POWER indicator will blink orange. In this case, press the POWER ON-OFF button again.
- When "Countdown off" or "Off" is selected in the Display function, the countdown will not be shown on the screen (p.36).
- During the countdown period, all operations are invalid.

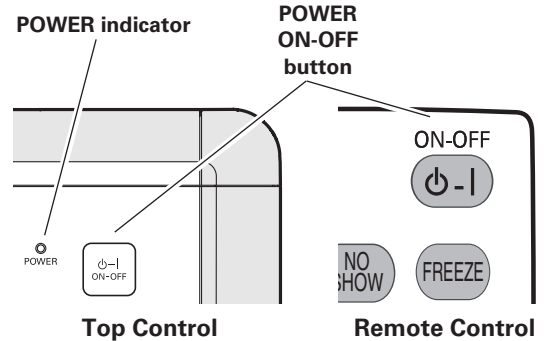

Main On/Off switch

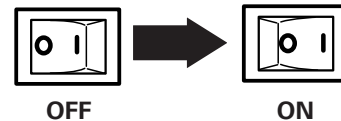

Selected Input Source



Automatic Slide Shutter

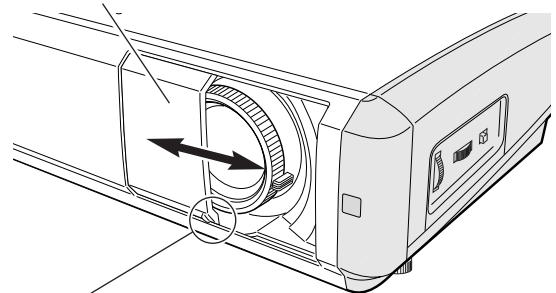

Use this tab when handling manually.



Do not touch the slide shutter while it is moving, as this could cause injury or the projector to malfunction.

Turning Off the Projector

1 Press the POWER ON-OFF button on the top control or on the remote control. "Power off?" appears on the screen. Press the POWER ON-OFF button again to turn off the projector.

(When the Power off confirmation function is "Off", the projector will be turned off without confirmation. (See "Power off confirmation" in the Setting Menu on page 37.)

The automatic slide shutter closes and the POWER indicator starts to blink red. The blinking continues for about 60 seconds while the cooling fans are operating.

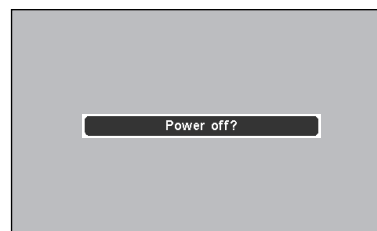

"Power off?" disappears after 4 seconds.

2 When the projector has cooled down enough to be turned on again, the POWER indicator will become red. Then you can turn the Main On/Off switch off and unplug the AC power cord.



TO MAINTAIN THE LIFE OF LAMP, ONCE YOU TURN THE PROJECTOR ON, WAIT AT LEAST FIVE (5) MINUTES BEFORE TURNING IT OFF.

DO NOT UNPLUG THE AC POWER CORD WHILE THE COOLING FANS ARE RUNNING OR BEFORE THE POWER INDICATOR STOPS BLINKING. OTHERWISE IT WILL RESULT IN SHORTENING THE LAMP LIFE.

✓ Note:

- If the automatic slide shutter is closed during operation, the projector is automatically turned off for safety. Be sure to turn off the projector by pressing the POWER ON-OFF button on the top control or on the remote control after use.
- While the POWER indicator is blinking, the lamp is being cooled down and the projector can not be turned on. Wait until the POWER indicator becomes red to be turned on again.
- Do not operate the projector continuously without rest. Continuous use may result in shortening the lamp life. Turn off the projector and rest it for about an hour in every 24 hours.
- The running speed of cooling fans is changed according to the temperature inside the projector.
- If the WARNING indicator blinks or emits a red light, see "Warning Indicator" on page 41.
- Do not put the projector in a case before it is cooled enough.

How to Operate the On-Screen Menu

The projector can be adjusted or set via the On-Screen Menu. The menus have a hierarchical structure, with a main menu that is divided into sub-menus, which are further divided into other sub-menus. Refer to the following pages regarding each adjustment and setting procedure.

- 1 Press the MENU button on the top control or on the remote control to display the On-Screen Menu.
- 2 Use the Point ▲▼ buttons to highlight or select a main menu item. Press the Point ► or OK buttons to access the sub-menu items. (The selected item is highlighted in ORANGE.)
- 3 Use the Point ▲▼ buttons to select the desired sub-menu item and press the Point ► or OK buttons to access the selected item.
- 4 Use the Point ◀▶ or OK buttons to adjust the setting or switch between each mode and press the OK or Point ► buttons to activate it and return to the sub-menu.
- 5 Return to the main menu by pressing the Point ◀ button. To exit the On-Screen Menu, press the MENU button again.

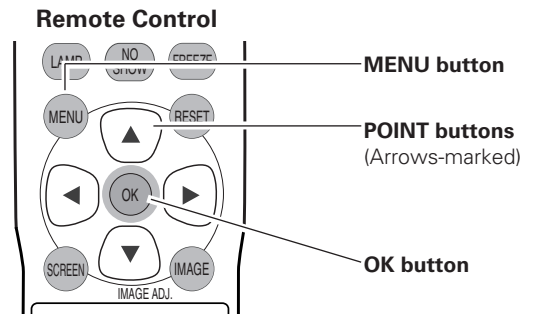
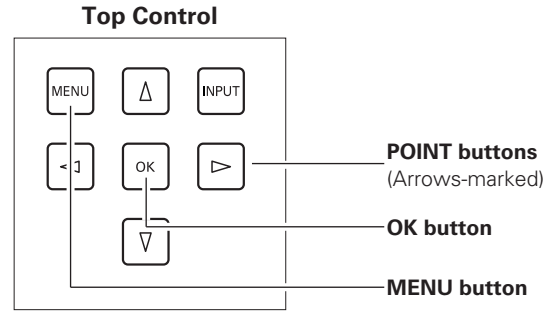

On-Screen Menu (Main Menu)

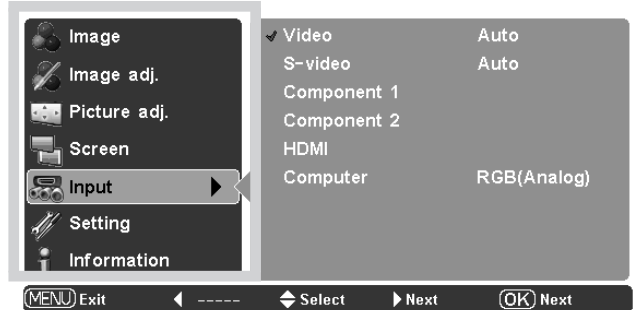

The selected item is highlighted in ORANGE.

On-Screen Menu (Sub-Menu)

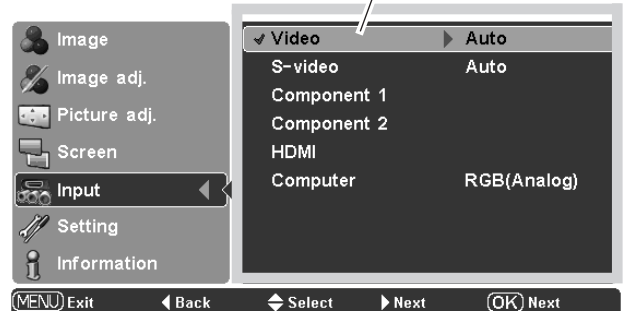

Menu and its Functions

For the detailed menu contents, see the Menu Tree on pages 50 ~ 51.

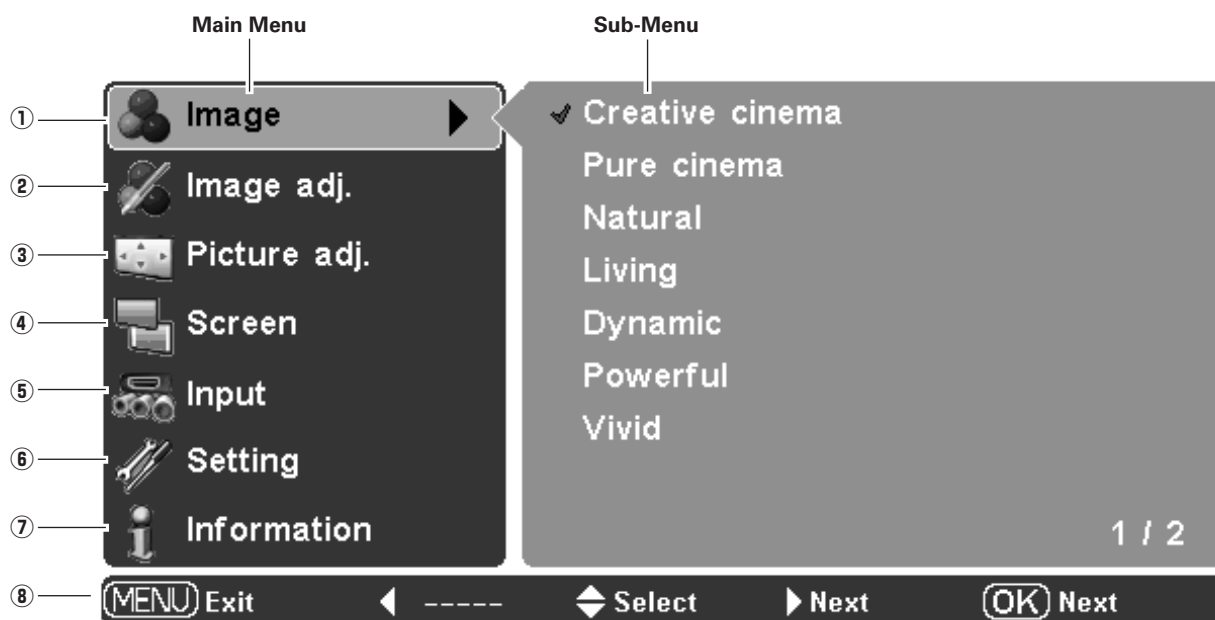

- ① **Image**
Select an image level from among Creative cinema, Pure cinema, Natural, Living, Dynamic, Powerful, Vivid, User Image 1 ~ 4 (p.27).
- ② **Image adj.**
Adjust Brightness, Contrast, Color, Tint, Color temp., White balance (R/G/B), Sharpness, Lamp control, Gamma, Progressive, Lens iris, Advanced menu, Reset, Store (p.28 ~ 31).
- ③ **Picture adj.**
Select Overscan, Horizontal, Vertical, Auto adj., Fine sync and Total dots to adjust the parameters to match with the input signal format (p.32).
- ④ **Screen**
Set the screen size from among Full, Full through, Zoom, Caption in, Normal, Normal through, Natural wide 1, Natural wide 2 (p.33 ~ 34).
- ⑤ **Input**
Select an input source from among Video, S-video, Component 1, Component 2, HDMI and Computer. For Video and S-video input, select a video system from AUTO, PAL, SECAM, NTSC, NTSC4.43, PAL-M, PAL-N (p.24 ~ 26).
- ⑥ **Setting**
Change various settings; Language, Advanced menu, Menu position, Keystone, Mounting, Rear, HDMI setup, Blue back, Display, Logo, Power off confirmation, Capture, Power management, Remote control, Shutter demo, Cleaning, Panel adjustment, Lamp counter reset, Factory default (p.35 ~ 39).
- ⑦ **Information**
Display Signal, H-sync freq., V-sync freq. of the projected screen and the Lamp Time (p.40).
- ⑧ **Guide**
The key operation is displayed.

Zoom and Focus Adjustment

Rotate the Zoom Lever to zoom in and out.
Rotate the Focus Ring to focus the image.

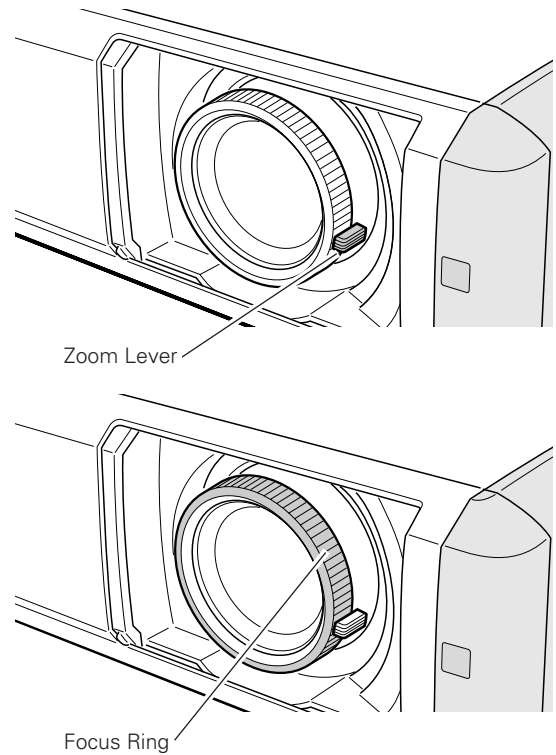

Remote Control Operation

For some frequently used operations, using the remote control is advisable. Just pressing one of the buttons enables you to make the operation, and no need for calling up the On-Screen Menu.

LIGHT button





Press the LIGHT button to light up the remote control buttons. The lights will be automatically turned off when no buttons on the remote control are pressed for 10 seconds.

FREEZE button

Press the FREEZE button to freeze the picture on the screen. To cancel the Freeze function, press the FREEZE button again or press any other button.

LAMP CONTROL button

Press the LAMP CONTROL button to select a lamp mode for changing the brightness of the screen.

-  Normal Normal brightness.
-  Auto 1 The brightness according to the input signal.
-  Auto 2 Less bright and lower-sound than Auto 1.
-  Eco Lower brightness reduces the lamp power consumption.

The lamp mode is automatically switched to the Eco mode under no signal input.

Remote Control

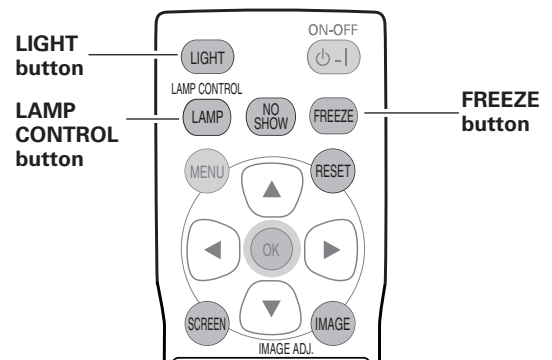

✓ **Note:**
• See the next page for other buttons.

SCREEN button

Press the SCREEN button to select the desired screen size. See page 33 for details.

NO SHOW button

Press the NO SHOW button to black out the image. To restore to normal, press the NO SHOW button again or press any other button.

RESET button

Press the RESET button to reset the adjusted data. All adjustments return to their previous figures. When selecting a main menu item, its entire sub-menu items will be reset. When selecting a sub-menu item, only the selected item will be reset. This function is limited to when selecting the Image Level Adjustment (p.28 ~ 31), Picture Adjustment (p.32) and the Keystone function in the Setting (p.35).

IMAGE ADJ. button

Press the IMAGE ADJ. button to display the Image adj. Menu items one at a time and directly adjust the selected item. See page 28 for details.

BRIGHTNESS button

To adjust the brightness, press the BRIGHTNESS button to display the adjustment bar and use the Point ◀▶ buttons to adjust the brightness. Press the MENU button after adjusting. See page 28 for details.

CONTRAST button

To adjust the contrast, press the CONTRAST button to display the adjustment bar and use the Point ◀▶ buttons to adjust the contrast. Press the MENU button after adjusting. See page 28 for details.

COLOR button

To adjust the color, press the COLOR button to display the adjustment bar and use the Point ◀▶ buttons to adjust the color. Press the MENU button after adjusting. See page 28 for details.

LENS IRIS button

To adjust the lens iris, press the LENS IRIS button to display the adjustment bar and use the Point ◀▶ buttons to adjust the lens iris. Press the MENU button after adjusting. See page 29 for details.

IMAGE buttons

Press the IMAGE buttons to select the desired image level of the screen. See page 27 for details.

✓ Note:

- If you press the OK button after adjusting each Image adj. Menu item or the brightness, contrast, color and lens iris, it enters the On-Screen Menu.

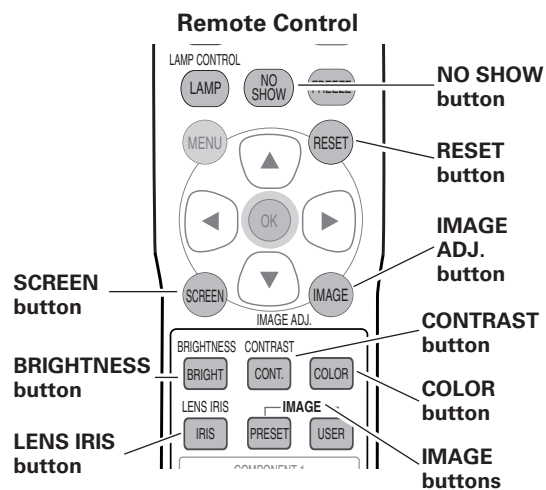

✓ Note:

- See the previous page for other buttons.

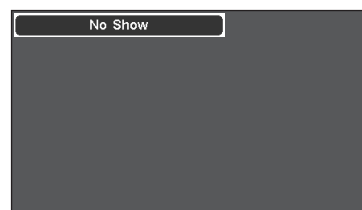

"No Show" disappears after 4 seconds.

Input Source and System Selection

Choose an input source by pressing the INPUT button on the top control or the INPUT buttons on the remote control.

✓ **Note:**

- Before selecting an input source with these buttons, each input must be set on a proper signal form via menu operation on pages 25 and 26.

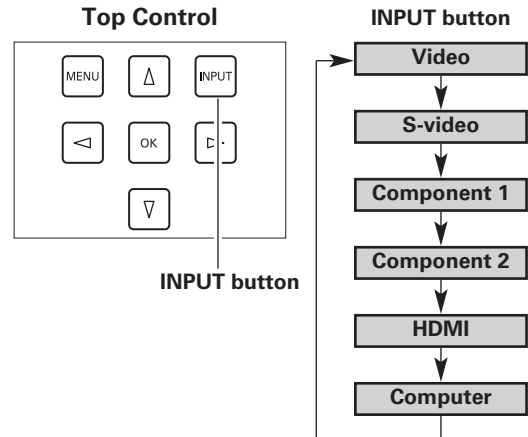

INPUT buttons

Press the VIDEO, S-VIDEO, C1, C2, HDMI or PC buttons on the remote control according to the input source.

- VIDEO** When the video input signal is connected to the VIDEO jack, select VIDEO.
- S-VIDEO** When the video input signal is connected to the S-VIDEO jack, select S-VIDEO.
- C1/C2** When the video input signal is connected to the Y-Pb/Cb-Pr/Cr jacks, select C1 or C2.
- HDMI** When the video input signal is connected to the HDMI terminal, select HDMI.
- PC** When the computer input signal is connected to the COMPUTER connector, select PC.

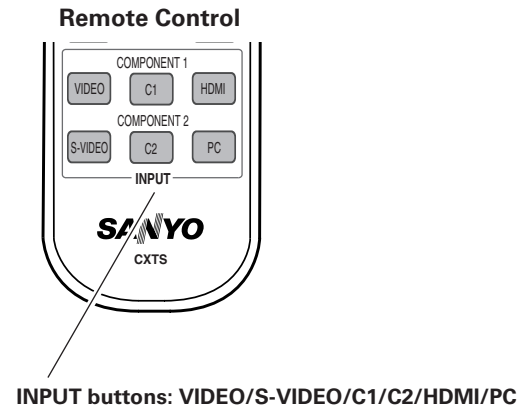

Menu Operation

- 1 Select the Input Menu with the Point ▲▼ buttons and press the Point ► or OK buttons to access the sub-menu items.
- 2 Use the the Point ▲▼ buttons to select an input source and press the OK or Point ► buttons. The selected item will be check marked.
- 3 When selecting Video or S-video, press the Point ► button to display the System Menu.
- 4 Use the Point ▲▼ buttons to select the desired system and press the OK or Point ► buttons.
- 5 When selecting Computer, press the Point ► button to display the Source Select Menu.
- 6 Use the Point ▲▼ buttons to select the desired source and press the OK or Point ► buttons.

Video or S-Video

When the video input signal is connected to the VIDEO or S-VIDEO jacks, select Video or S-video respectively.

Auto

The projector automatically detects the incoming video system and adjusts itself to optimize its performance.

When the video system is PAL-M or PAL-N, select the system manually.

PAL / SECAM / NTSC / NTSC4.43 / PAL-M / PAL-N

If the projector cannot reproduce a proper video image, select a specific broadcast signal format from among PAL, SECAM, NTSC, NTSC 4.43, PAL-M, and PAL-N.

Component 1 or 2

When the video input signal is connected to the Y-Pb/Cb-Pr/Cr jacks, select Component 1 or 2.

The projector automatically detects the incoming video signal and adjusts itself to optimize its performance.

Input Menu

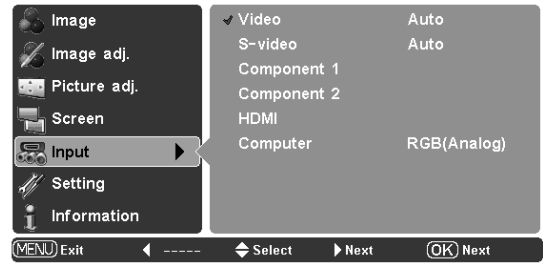

The currently set item is check marked.

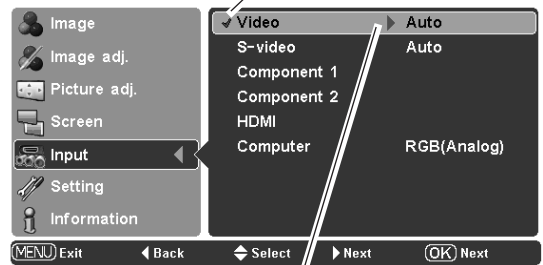

Press the Point ► button to display the System Menu.

System Menu (Video/S-Video)

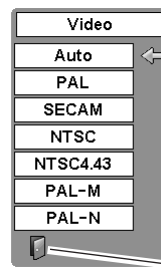

Use the Point ▲▼ buttons to select the desired system and press the OK or Point ► buttons.

Quit
Exit this menu.

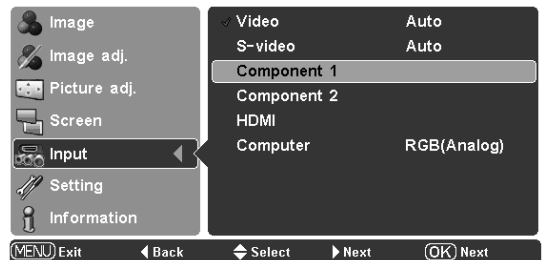

HDMI

When the video input signal is connected to the HDMI terminal, select HDMI.

The projector automatically detects the incoming video signal and adjusts itself to optimize its performance.

If the output signal of video equipment and the input signal of the projector do not match, you might not get an image with the best quality.

If the black part of the picture appears unclear (too dark or too light), try the input signal with "HDMI setup" in the Setting Menu on page 36.

Computer

When the input signal is connected to the COMPUTER connector, select Computer.

RGB (Analog) When the input source is analog coming from a computer connected to the COMPUTER connector, select RGB (Analog).

RGB (Scart) When the input terminal is Scart with a DVD player connected to the COMPUTER connector, select RGB (Scart).

This projector automatically tunes to various types of computers based on VGA, SVGA, XGA or SXGA with its Multi-scan system and the Auto adj. function (p.32). If Computer is selected as a signal source, this projector automatically detects the signal format and tunes to project a proper image without any additional setting. (The signal formats provided in this projector is shown on page 52.)

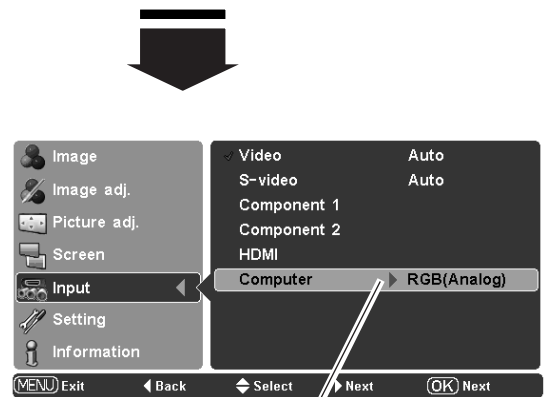
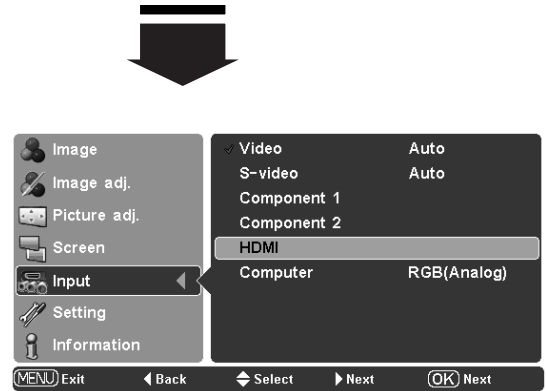

Computer Input

Press the Point ► button to display the Source Select Menu.

Source Select Menu

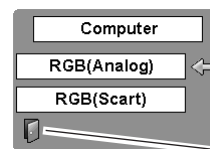

Use the Point ▲▼ buttons to select the desired source and press the OK or Point ► buttons.

Quit
Exit this menu.

Image Level Selection

Image level selection can be made for each input source.

Direct Operation

Select the desired image level among Creative cinema, Pure cinema, Natural, Living, Dynamic, Powerful, Vivid, User Image 1 ~ 4 by pressing the IMAGE buttons (PRESET or USER) on the remote control.

Use the PRESET button to select Creative cinema, Pure cinema, Natural, Living, Dynamic, Powerful and Vivid. Use the USER button to select User image 1 ~ 4.

Menu Operation

- 1 Select the Image Menu with the Point ▲▼ buttons and press the Point ► or OK buttons to access the sub-menu items.
- 2 Use the Point ▲▼ buttons to select the desired image level and press the OK or Point ► buttons. The selected item will be check marked.

Creative cinema

Suitable for viewing contrasty 3D images in a dark room.

Pure cinema

Suitable for viewing images with quiet tones of color with less gradation in a dark room.

Natural

Suitable for viewing faithfully reproduced images without any control by the projector in a dark room.

Living

Suitable for viewing video sources such as sports or dramas from TV with clear and contrasty images in a bright room.

Dynamic

Suitable for viewing contrasty images in a bright room.

Powerful

Suitable for viewing with a big screen in a bright room.

Vivid

Suitable for viewing contrasty images to a maximum extent.

User image 1 ~ 4

User preset images in the Image adj. Menu (p.28 ~ 31).

✓ **Note:**

- The Image Menu cannot be operated without an input signal.

Remote Control

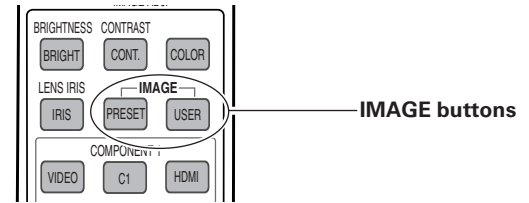

PRESET button

Creative cinema → Pure cinema → Natural → Living → Dynamic → Powerful → Vivid →

USER button

User image 1 → User image 2 → User image 3 → User image 4 →

Image Menu

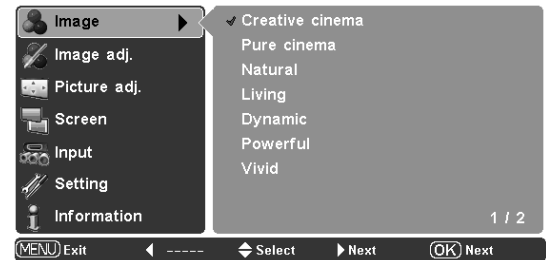

The selected image level.

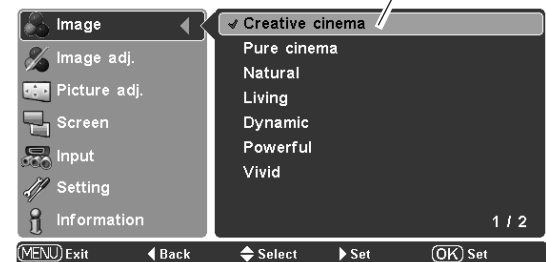

Press the Point ▼ button to move on to the next items.



Image Adjustment

Image Level Adjustment

Image level can be adjusted for each input source and the adjustment is kept until the projector is turned off.

Direct Operation

Press the IMAGE ADJ. button on the remote control to display the Image adj. Menu items one at a time and directly adjust the selected item.

Use the Point ▲▼ buttons to select the desired item and the Point ◀▶ buttons to adjust the settings. Press the MENU button after adjusting.

If you press the OK button after adjusting each item, it enters the On-Screen Menu.

Menu Operation

- 1 Select the Image adj. Menu with the Point ▲▼ buttons and press the Point ▶ or OK buttons to access the sub-menu items.
- 2 Use the Point ▲▼ buttons to select the desired item and press the Point ▶ or OK buttons to access the selected item. The adjustment bar will be displayed.
- 3 Use the Point ◀▶ buttons to adjust the setting values and press the OK button.

Brightness

Press the Point ◀ button to decrease the brightness; press the Point ▶ button to increase the brightness. (From -31 to +31.)

Contrast

Press the Point ◀ button to decrease the contrast; press the Point ▶ button to increase the contrast. (From -31 to +31.)

Color

Press the Point ◀ button to decrease the intensity of the color; press the Point ▶ button to increase the intensity of the color. (From -31 to +31.)

Tint

Use the Point ◀▶ buttons to adjust the tint value to obtain a proper color balance. (From -31 to +31.)

Color temp.

Use the Point ◀▶ buttons to select the desired Color temp. level. (High, Mid, Low1, Low2, or Low3.)

✓ Note:

- Tint cannot be selected when the video system is PAL, SECAM, PAL-M, or PAL-N except for 575i.
- The Image adj. Menu cannot be operated without an input signal.

Remote Control

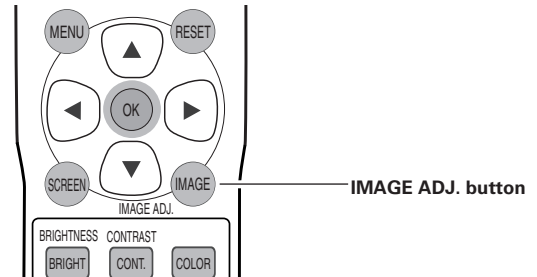

Brightness → Contrast → Color → Tint → Color temp. → Red → Green → Blue → Sharpness → Lamp control → Gamma → Progressive → Lens iris → Lamp iris → Auto black stretch → Contrast enhancement → Transient improvement → Gain R/G/B → Offset R/G/B → Gamma R/G/B →

Image adj. Menu

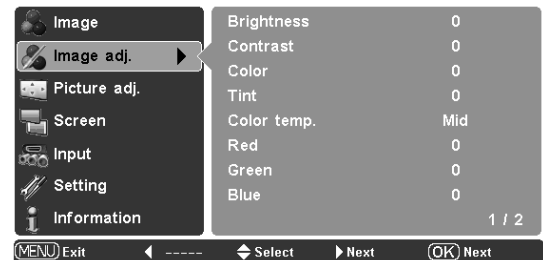

The selected item.

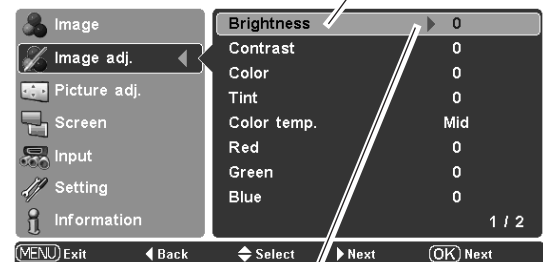

Press the Point ▶ or OK buttons to access the selected item. The adjustment bar will be displayed.



Use the Point ◀▶ buttons to adjust the setting values and press the OK button. If you press the Point ▼ button, the next item can be selected.

Go on to the next page...

White balance (Red)

Press the Point ◀ button to lighten red tone; press the Point ▶ button to deepen red tone. (From -31 to +31.)

White balance (Green)

Press the Point ◀ button to lighten green tone; press the Point ▶ button to deepen green tone. (From -31 to +31.)

White balance (Blue)





Press the Point ◀ button to lighten blue tone; press the Point ▶ button to deepen blue tone. (From -31 to +31.)

Sharpness

Press the Point ◀ button to decrease the sharpness of the image; press the Point ▶ button to increase the sharpness of the image. (From -7 to +7.)

Lamp control

This function allows you to change the brightness of the screen. Use the Point ◀▶ buttons to select the desired lamp mode. You can also select the lamp mode by pressing the LAMP CONTROL button on the remote control.

-  Normal Normal brightness.
-  Auto 1 The brightness according to the input signal.
-  Auto 2 Less bright and lower-sound than Auto 1.
-  Eco Lower brightness reduces the lamp lower consumption.

The lamp mode is automatically switched to the Eco mode under no signal input.

Gamma

Use the Point ◀▶ buttons to adjust the gamma value to obtain a better balance of contrast. (From -7 to +7.)

Progressive

An interlaced video signal can be displayed in progressive. Use the Point ◀▶ buttons to select the desired mode.

- Off Disabled.
- L1 Select "L1" for moving pictures.
- L2 Select "L2" for still pictures.
- Film Select "Film" for watching a film. With this function, the projector reproduce pictures faithful to the original film quality; it operates on 3-2 and 2-2 pulldown video sources.

Lens iris

Use the Point ◀▶ buttons to adjust the lens iris. It can be stopped down from zero. (From 0 to -63.)

✓ Note:

- If any of the White balance (Red, Green or Blue) is adjusted, the Color temp. level will change to "User".
- Progressive cannot be selected with the computer input and when the video signal format is 480p, 575p, or 720p.
- The Film mode in the Progressive function cannot be selected when the video signal format is 1080i. If you select the Film mode when the video signal format is 480i and then input 1080i signal, it will switch to the L1 mode.

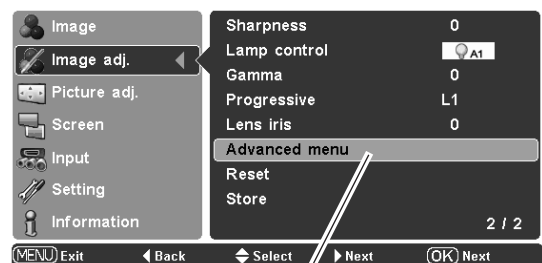
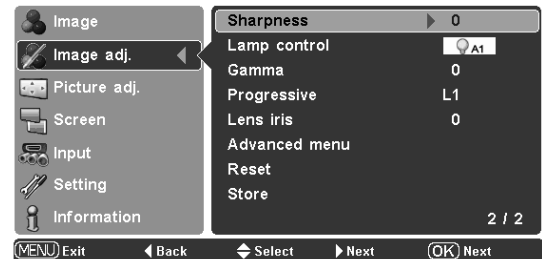

Press the Point ▶ or OK buttons to display the Advanced menu.



Press the Point ▼ button to move on to the next items.



Go on to the next page...

Advanced menu

This function can be selected only when Advanced menu in the Setting Menu (p.35) is "On". You can adjust the following items through this function.

- Lamp iris Select Auto, Open or Close for the Lamp iris.
- Auto black stretch Enhance the black color in a bright image. Select Off/ L1/L2/L3.
- Contrast enhancement Adjust the contrast of color in a bright image. Select Off/ L1/L2/L3.
- Transient improvement Adjust the sharpness of picture outline. Select Off/ L1/L2/L3.
- Color management Adjust color level, color phase and gamma of the selected spot of a projected image. Exchange the original color with the adjusted one. The projector can store up to eight (8) color management data. For details, see "COLOR MANAGEMENT" below.
- Gain R/G/B Adjust red, green and blue to get the desired contrast of color.
(From -15 to +15.)
- Offset R/G/B Adjust red, green and blue to get the desired brightness of color.
(From -15 to +15.)
- Gamma R/G/B Adjust red, green and blue to get the desired neutral color.
(From -5 to +5.)

COLOR MANAGEMENT

COLOR MANAGEMENT LIST

Select Color management in the Advanced menu and then press the OK or Point ► buttons. The COLOR MANAGEMENT LIST will appear. You can store up to eight (8) color management data in the list.

Press the OK button when selecting the following items.

ALL DEL Delete all the data in the list.
Press the OK button and the confirmation box will appear. Select [Yes] and press the OK or Point ► buttons.

COLOR M. Go to COLOR SELECTION on the next page.

EXIT Exit the Color management mode and return to the Advanced menu. To store the adjusted data, see "Store" in the next page.

Press the MENU button when you want to return to the Advanced menu.

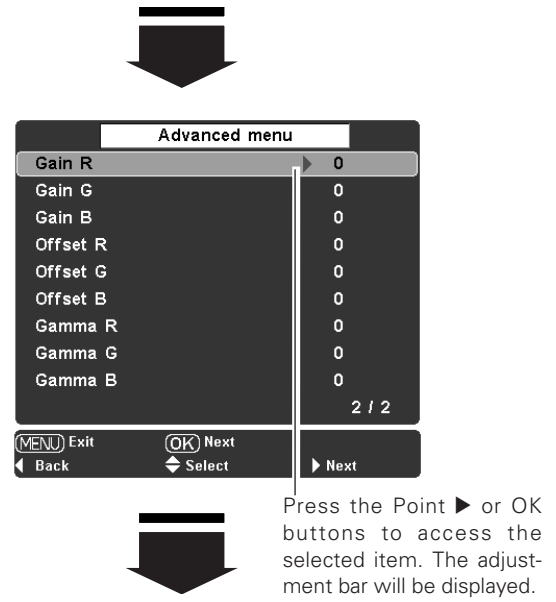

Press the Point ► or OK buttons to access the selected item. The adjustment bar will be displayed.



Use the Point ◀▶ buttons to adjust the setting values and press the OK button. If you press the Point ▼ button, the next item can be selected.

COLOR MANAGEMENT LIST

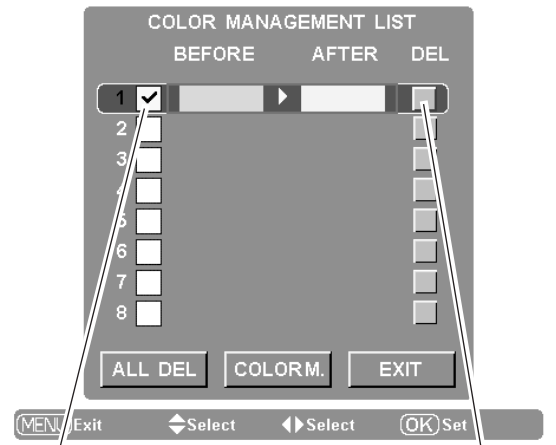

Clear the check mark if you do not want to apply this adjusted color data to a projected image.

Select the DEL box if you want to delete the adjusted data. The confirmation box will appear.



Select [Yes] to delete the adjusted color data.

COLOR SELECTION

Press the OK button when selecting COLOR M. in the Color management list. The Color management list disappears and the Color management pointer will appear.

Use the Point ▲▼◀▶ buttons to move the pointer to a spot where you want to adjust the color and then press the OK button. The image being projected freezes and the COLOR SELECTION window will appear. (Certain colors may not be adjusted and in such cases, an exclamation mark will be displayed.)

Select COLOR LEVEL, COLOR PHASE or GAMMA with the Point ▲▼ buttons and use the Point ◀▶ buttons to adjust them. While adjusting, the changes are reflected in the projected image accordingly. If you press the MENU button while operating the color selection, the Color management pointer will be reset. After adjusting, press the OK button to go to the Color management list.

COLOR MANAGEMENT LIST (continued)

In the COLOR MANAGEMENT LIST, the adjusted color data are check marked reflecting the changes in the projected image. (See the previous page.)

You can also decide whether or not to apply the adjusted color data in the list to a projected image. Clear the check mark if you do not want to apply the adjusted color data; select the check mark and then press the OK button. The check mark will disappear.

If you want to readjust the color, select a color data box in the list and press the OK button. The COLOR SELECTION window will appear and you can readjust the color. See above for color selection.

If you want to delete a particular color data in the list, select the DEL box of the color data and then press the OK button. The confirmation box will appear. Select [Yes] and then press the OK or Point ▶ buttons.

Reset

To reset the adjusted data, select Reset and press the Point ▶ or OK buttons. The confirmation box will appear. Select [Yes] and then press the OK or Point ▶ buttons. All adjustments return to their previous figures. You can also reset the adjusted data with the RESET button on the remote control.

Store

To store the adjusted data, select Store and press the Point ▶ or OK buttons. The Image Level Menu will appear. Choose one of the four (4) image levels with the Point ▲▼ buttons and press the OK or Point ▶ buttons. The confirmation box will appear. Select [Yes] and then press the OK or Point ▶ buttons. To exit the Image Level Menu, press the OK or Point ▶ buttons at the Quit icon.

The stored data can be called up by selecting "User image 1 ~ 4" in the Image Level Selection on page 27.

✓ Note:

- If you turn off the POWER without storing adjusted settings, all the adjusted settings will be reset.
- When resetting, the adjusted data in Advanced menu will be reset whether or not Advanced menu in the Setting Menu is "On". See on page 35.

COLOR SELECTION

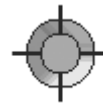

Color management pointer

Use the Point ▲▼◀▶ buttons to move the pointer to a spot where you want to adjust the color and then press the OK button. The COLOR SELECTION window will appear.



After adjusting Color level, Color phase and Gamma, press the OK button.

Go to the Color management list (see the previous page).



To store the adjusted data, exit the Color management mode and move on to "Store" in the Image adj. Menu.

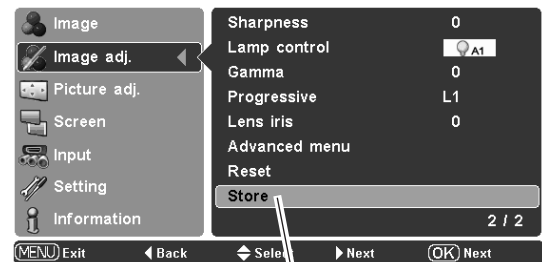

Press the Point ▶ or OK buttons at this icon to store the adjusted data. The Image Level Menu will appear.

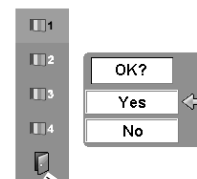

Choose one of the four (4) image levels with the Point ▲▼ buttons and press the OK or Point ▶ buttons. The confirmation box will appear. Select [Yes] and then press the OK or Point ▶ buttons.

Quit

Press the OK or Point ▶ buttons at this icon to close the dialog box.

Picture Adjustment

Picture Position and Screen Adjustment

Some input source employ special signal formats which may not be tuned by the auto-tuning system of this projector. Picture Adjustment enables you to precisely adjust several parameters manually to match those signal formats. The parameters manually adjusted will be stored for every input.

- 1 Select the Picture adj. Menu with the Point ▲▼ buttons and press the Point ► or OK buttons to access the sub-menu items.
- 2 Use the Point ▲▼ buttons to select the desired item and press the Point ► or OK buttons to access the selected item. The adjustment bar will be displayed.
- 3 Use the Point ◀▶ buttons to adjust the setting values and press the OK button.

Overscan

Use the Point ◀▶ buttons to adjust the overscan area. It works only to decrease the overscanned portion of the screen. (From 0 to +10.)

Horizontal

Use the Point ◀▶ buttons to adjust the horizontal picture position. (From -100 to +100.)

Vertical

Use the Point ◀▶ buttons to adjust the vertical picture position. (From -100 to +100.)

Auto adj.

When the input signal is from a computer, select Auto adj. Press the Point ► or OK buttons and it automatically adjust Fine sync. Total dots, Horizontal and Vertical positions to conform to your computer.

Fine sync

Eliminate a flicker from the image displayed. Use the Point ◀▶ buttons to adjust the value. (From 0 to +31.)

Total dots

Adjusts the number of total dots in one horizontal period. Use the Point ◀▶ buttons to adjust the number to match your PC image. (From -100 to +100.)

✓ Note:

- Overscan can be selected with the video input only.
- The adjusting range for the Horizontal and Vertical positions and Total dots differs depending on the input signal. When the video signal format is 480i or 575i, the adjusting range for the Horizontal position will be from -8 to +8.
- The Auto adj. function cannot be operated with the video input, some incompatible computer input and digital signals.
- Fine sync and Total dots cannot be operated when the video signal format is 480i or 575i and with some incompatible computer input and digital signals.
- The Picture adj. Menu cannot be operated without an input signal.

Picture adj. Menu

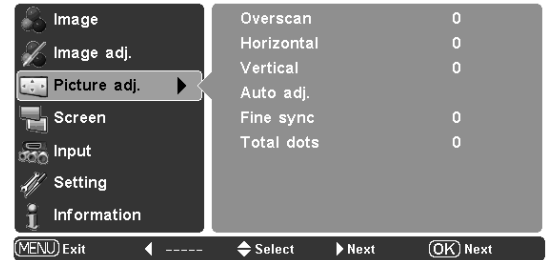

The selected item.

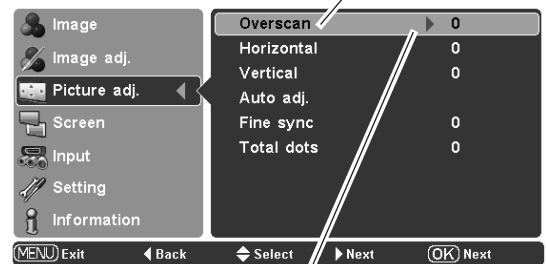

Press the Point ► or OK buttons to access the selected item. The adjustment bar will be displayed.



Use the Point ◀▶ buttons to adjust the the setting values and press the OK button to return to the sub-menu.

If you press the Point ▼ button, the next item can be selected.

Screen Size Adjustment

This projector has the picture screen resize function which enables you to customize the image size.

Direct Operation

Select a screen size among Full, Full through, Zoom, Caption in, Normal, Normal through, Natural wide 1 and Natural wide 2 by pressing the SCREEN button on the remote control.

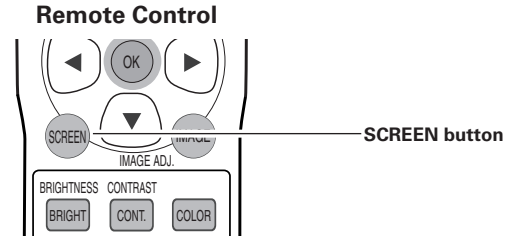

Full → Full through → Zoom → Caption in → Normal → Normal through → Natural wide 1 → Natural wide 2 →

Menu Operation

- 1 Select the Screen Menu with the Point ▲▼ buttons and press the Point ► or OK buttons to access the sub-menu items.
- 2 Use the Point ▲▼ buttons to select the desired screen size and press the OK or Point ► buttons. The selected item will be check marked.

Full

Fit the image to the screen by expanding the width of the image uniformly. This function can be used to project a squeezed video signal at the wide video aspect ratio of 16 : 9.

To get a better quality, select the 16 : 9 output mode as well if it is available on your video equipment (such as DVD players).

Full through

Fit the image to the screen by expanding the width of the image and project it in the center of the screen at the wide screen ratio of 16 : 9. (You can enjoy a high-quality image even though the projected image is smaller.)

Zoom

Fit the image to the screen size (16 : 9 aspect ratio) by expanding the width and height of the image uniformly.

With the input signals other than 1080i or 720p, this function is used to project a letterboxed picture (the 4 : 3 aspect ratio picture with a black bar at the top and bottom) at the wide video aspect ratio of 16 : 9.

When the input signal is 1080i or 720p, a letterboxed picture in a 16 : 9 screen can be projected by expanding at the wide video aspect ratio of 16 : 9.

You can also adjust the display range with the vertical adj. function in the Zoom mode. See "Vertical adj." on the next page for details.

Screen Menu

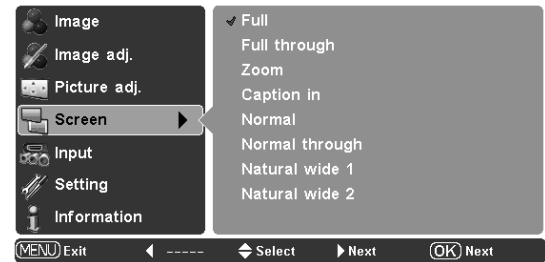

The selected screen size.

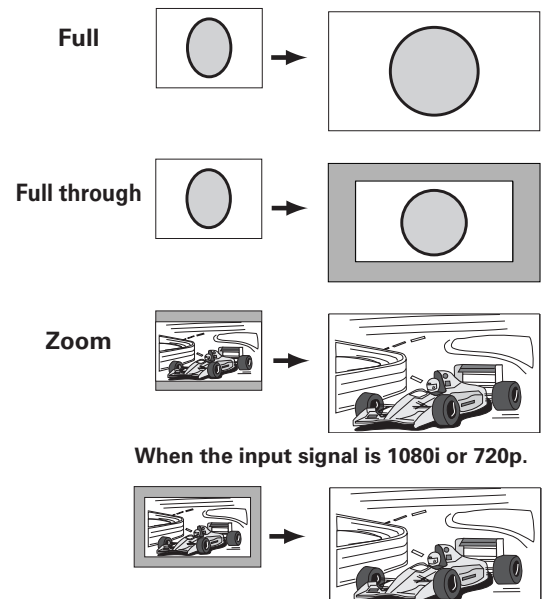
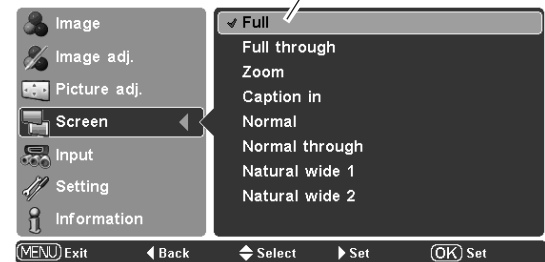

✓ **Note:**

- The Screen Menu cannot be operated without an input signal.

Caption in

Fit the image to the screen size (16 : 9 aspect ratio) by compressing the image including the captions.

With the input signals other than 1080i or 720p, this function is used to project a 4 : 3 picture with captions at the wide video aspect ratio of 16 : 9.

When the input signal is 1080i or 720p, a picture with captions in a 16 : 9 screen can be projected by expanding at the wide video aspect ratio of 16 : 9.

If a part of the captions is out of the screen, adjust the display range with the Vertical adj. function. See "Vertical adj." below for details.

Normal

Fit the image to the center of the screen at the normal video aspect ratio of 4 : 3.

Normal through

Fit the image to the center of the screen without modification. (You can enjoy a high-quality image even though the projected image is smaller.)

When the original image size is larger than the screen size (1280 x 720), adjust the display range with the Panning function.

Natural wide 1

Modify a 4 : 3 aspect ratio image to fit the screen size (16 : 9 aspect ratio) by stretching the image to make it look natural.

Natural wide 2

When the signal is 16 : 9, modify a 4 : 3 aspect ratio image to fit the screen size (16 : 9 aspect ratio) by stretching the image to make it look natural.

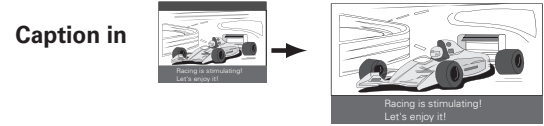

When the input signal is 1080i or 720p.

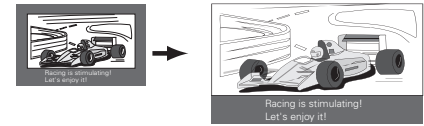

Normal

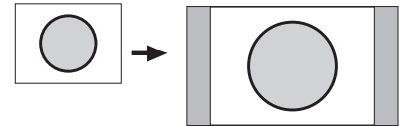

Normal through

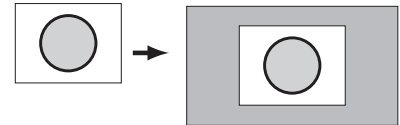

Natural wide 1

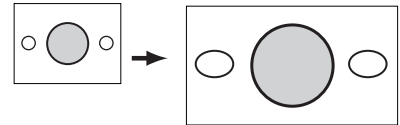

Natural wide 2

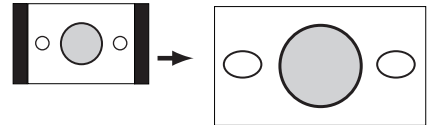

Vertical adj.

When it is in the Zoom or Caption in mode, press the Point ▲▼ buttons to display the Vertical adj. dialog box. Use the Point ▲▼ buttons to adjust the vertical position. The adjusting range differs depending on the input signal.

The adjusted value is only effective in the Zoom and Caption in mode.

The Vertical adj. dialog box cannot be displayed when the On-Screen Menu is on.



Panning

When it is in the Normal through mode, press the Point ▲▼ buttons to display the panning dialog box. Use the Point ▲▼◀▶ buttons to pan the image. Only the displayed direction of arrows are active.

The panning dialog box cannot be displayed when the On-Screen Menu is on.



✓ Note:

- When the video signal format is 720p, 1080i, or HDTV, the Screen Menu cannot be selected except for Full, Zoom, Caption in and Natural wide 2.
- When Normal is selected with a computer input, the image is projected at the inputted resolution.
- This projector cannot display any resolution higher than 1920 x 1080. If your computer's resolution is higher than that, lower the resolution before connecting to the projector.
- The image data other than the 1280 x 720 resolution is modified to fit the screen size in initial mode.
- The Vertical adj. function is operated only when Zoom or Caption in is selected.
- The panning function for Normal through is operated only with a computer input.

Setting

Setting

The Setting Menu allows you to set up other various functions described below.

- 1 Select the Setting Menu with the Point ▲▼ buttons and press the Point ► or OK buttons to access the sub-menu items.
- 2 Use the Point ▲▼ buttons to select the desired item and press the Point ► or OK buttons to access the selected item.
- 3 Use the Point ▲▼ or OK buttons to adjust the setting.

Language

The language used in the On-Screen Menu is available in English, German, French, Italian, Spanish, Portuguese, Dutch, Swedish, Finnish, Polish, Hungarian, Romanian, Russian, Chinese, Korean, or Japanese.

Advanced menu

When this function is "On", the Advanced menu in the Image Level Adjustment can be selected. Press the Point ► or OK buttons to switch On/Off. See "Image Level Adjustment" on page 30 for details.

Menu position

This function is used to change the position of the On-Screen Menu. Select Menu position and press the Point ► or OK buttons. The Menu position screen will appear. Select the desired position with the Point ▲▼◀▶ buttons and press the OK button.

Keystone

When the image is distorted vertically, select Keystone and press the Point ► or OK buttons. The On-Screen Menu disappears and the Keystone dialog box will appear. Correct keystone distortion by pressing the Point ▲▼ buttons.

Reduce the upper width with the Point ▲ button.

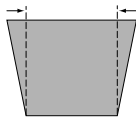

Reduce the lower width with the Point ▼ button.

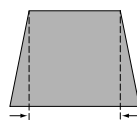

- The arrows are white when there is no correction.
- The arrows disappear at the maximum correction.
- The arrows in the corrected direction will turn orange.
- The Keystone dialog box will disappear when the Keystone function is not operated for four (4) seconds.

✓ Note:

- If you press the RESET button on the remote control while selecting Keystone, the adjustment will go back to the factory default setting.

Setting Menu

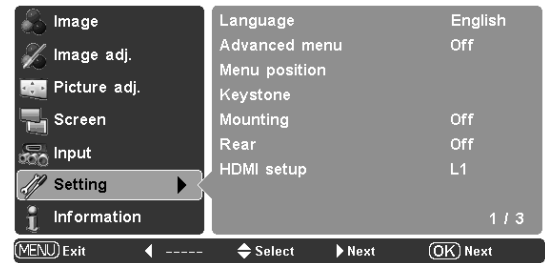

Language

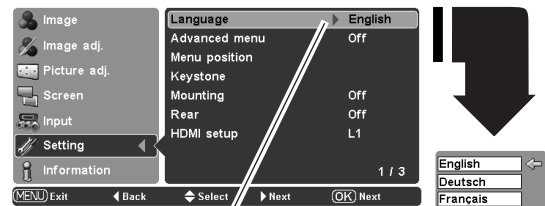

Press the Point ► or OK buttons to display the Language Menu.

Choose a language and press the OK or Point ► buttons. The pointer will move to this icon. Press the OK or Point ► buttons again to activate it.

Menu position

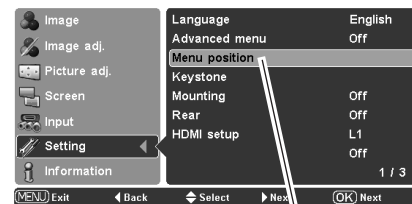

Select Menu position and press the Point ► or OK buttons. The Menu position screen will appear.

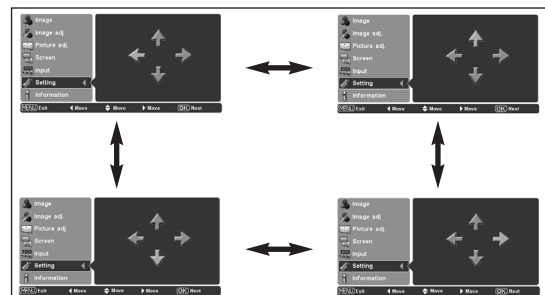

Mounting

This function is used to select the installation methods of the projector. Press the Point ► or OK buttons to switch between each mode.

- Off Cancel the selected installation method.
- Ceiling Project the image from the ceiling-mounted projector. The picture is top/bottom and left/right reversed.
- Wall Project the image from a wall-hanging projector. The picture is left/right reversed.

Rear

When this function is "On," the picture is left/right reversed. This function is used to project the image to a rear projection screen. Press the Point ► or OK buttons to switch On/Off.

HDMI setup

Select L1 or L2 with the Point ► or OK buttons according to the output signal of video equipment.

- L1 When the output of video equipment is set "STANDARD".
- L2 When the output of video equipment is set "ENHANCED".

The names for the output setting of video equipment vary from equipment to equipment. For details, refer to the owner's manual of video equipment.

Blue back

When this function is "On", the projector produces a blue image while an input signal is not detected. Press the Point ► or OK buttons to switch On/Off.

Display

This function decides whether to display the On-Screen Displays. Press the Point ► or OK buttons to switch between each mode.

- On Show all the On-Screen Displays. Use this function when you want to project images after the lamp becomes bright enough. The factory default setting is this mode.
- Countdown Off Show the input image instead of the countdown when turning on the projector. Use this function when you want to project the image as early as possible even when the lamp is not bright enough.
- Off Hide the On-Screen Displays except;
 - On-Screen Menu
 - "Power off?"
 - "No signal" for Power management (p.37)
 - "Please wait ..."
 - Color management operation screen
 - Panning dialog box when Normal through is selected in the Screen Menu (p.34).

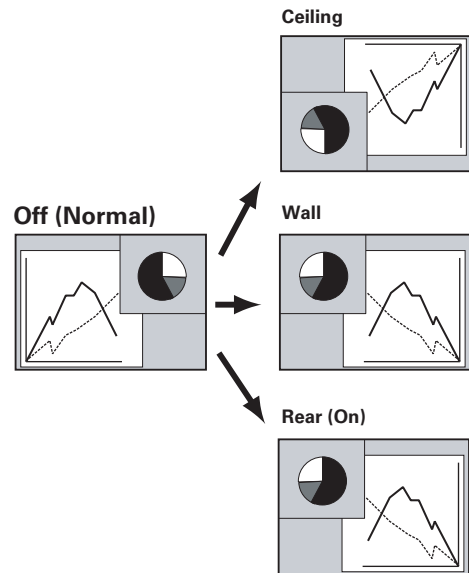

HDMI setup

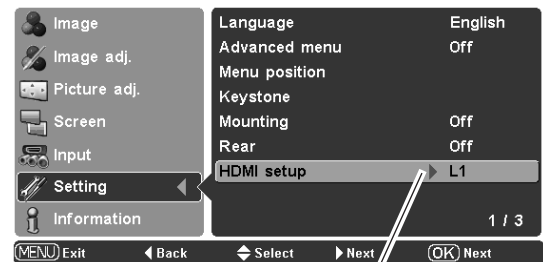

Press the Point ► or OK buttons to select L1 or L2 according to the output signal of video equipment.

Logo

This function decides on the starting-up display from among the following options. Press the Point ► or OK buttons to switch between each mode.

- User Show the Image you captured.
- Default Show the factory-set logo.
- Off Show the Countdown display only.

Power off confirmation

When this function is “On”, the confirmation dialog box with “Power off?” is displayed when turning off the projector (p.19). Press the Point ► or OK buttons to switch On/Off.

Capture

This function enables you to capture an image being projected to use it for the starting-up display or interval of presentations. Select Capture and press the Point ► or OK buttons. The confirmation box appears and select [Yes] to capture the projected image.

After capturing the projected image, go to the Logo function and set it to “User”. Then the captured image will be displayed the next time the projector is turned on.

To cancel the Capture function, select [No].

✔ **Note:**

- A signal from a computer can be captured up to XGA (1024 x 768).
- The image that has been adjusted in the Image adj. Menu cannot be captured.
- When capturing the image that has been adjusted by the Keystone function, the adjusted data is automatically reset and the projector captures an image without keystone correction.
- If the Capture function fails to capture an image or stops capturing halfway, the On-Screen Menu returns to the Capture item.
- The Capture function cannot be operated with unsupported signals.
- When starting to capture a new image, the previously stored image is cleared even if you cancel the capturing.

Power management

For reducing power consumption as well as maintaining the lamp life, the Power management function turns off the projection lamp when the projector is not used for a certain period.

When this function is “On” and if the input signal is interrupted and no button is pressed for more than 30 seconds, the timer display with “No signal” appears on the screen. It starts the countdown until the lamp is turned off. The countdown time is set to five (5) minutes.

When the countdown time has elapsed, the lamp will be turned off to cool itself down. The POWER indicator is blinking red during the cooling-off period. When the lamp has been fully cooled down, the POWER indicator changes to green blinking. In this condition, the projection lamp can be turned on when the input signal is reconnected or any button on the top control or remote control is pressed.

Press the Point ► or OK buttons to switch On/Off.

Capture

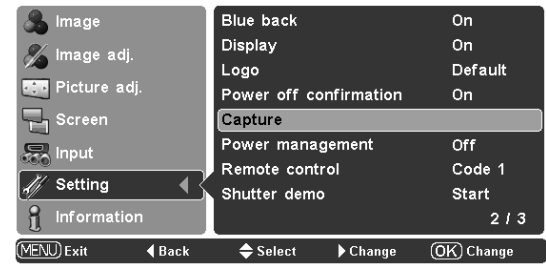

Select [Yes] to capture the projected image.

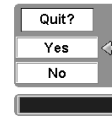

Select [Yes] to stop capturing.

Power management

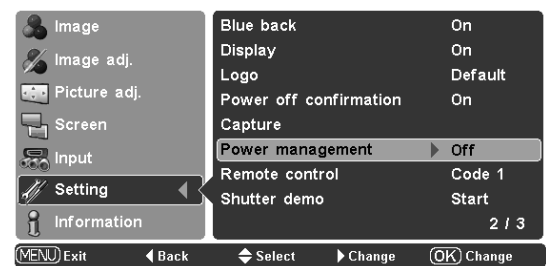

The time left until lamp off

Remote control

Two different remote control codes are assigned to this projector: the factory-set code (Code 1) and the secondary code (Code 2). This switching function prevents interference from other remote controls when several projectors or video equipment next to each other are used at the same time.

When operating the projector in "Code 2", the code for both the projector and the remote control must be switched to "Code 2".

To change the code of the projector:

Press the Point ► or OK buttons to switch between Code 1 and Code 2.

To change the code of the remote control:

Press and hold both MENU and IMAGE button on the remote control for more than 10 seconds to switch between Code 1 and Code 2.

After changing the code, make sure the remote control operates properly.

✓ Note:

- When the batteries of the remote control are replaced, the remote control code automatically returns to the initial code (Code 1).

Shutter demo

Press the Point ► or OK buttons to start Shutter demo. The automatic slide shutter closes once with the lamp being turned on and will open up again. This is used for checking the operation of the automatic slide shutter.

Cleaning

This function is used to clean the inside of the projector. Using a blower as well is more effective. (See page 43.)

Press the Point ► or OK buttons, then the projected image is blacked out temporarily regardless of whether or not an input source is selected. The fan starts to operate automatically to help blowing the dust.

To cancel the cleaning function, press any other button during cleaning operations.

✓ Note:

- The Power management function cannot be operated during cleaning.

Remote control

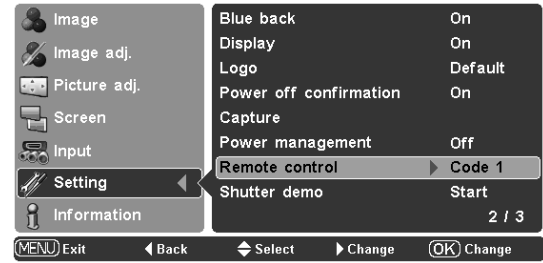

Shutter demo

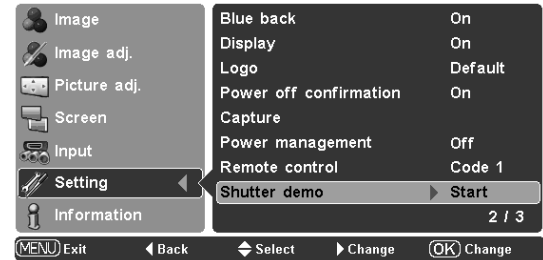

Panel adjustment

This function is used to get the best picture reproduction of the R (red), G (green) and B (blue) LCD panels. If the proper adjustment is not made, you might get vertical noise lines on the screen.

This function should be made more than 10 minutes after turning on the projector with or without any signal.

A dark environment helps make more accurate adjustment.

Press the OK button or Point ► button and the Test pattern screens will appear in the order of R (red), G (green), B (blue). Use the Point ▲▼◀▶ buttons to adjust each pattern as follows:

1. Adjust the value in the Bright dialog box to minimize vertical lines in the bright part of the picture.
2. Adjust the value in the Dark dialog box to minimize vertical lines in the dark part of the picture.
3. Press the Point ▲▼ buttons to move on to the next color. Repeat step 1 and 2 for each R,G,B panel until the vertical lines of the picture are minimized.
4. Press the Point ▲▼ buttons to display the Check pattern screen and check the adjustment.
5. To close this screen and return to the menu, press the OK or MENU button.

Lamp counter reset

This function resets the lamp replacement counter. When replacing the projection lamp, reset the lamp replacement counter with this function. See page 47 for operation.

Factory default

This function restores all setting values except for the user's logo and the lamp counter to the factory default settings.

1. Adjust the bright parts with the Bright dialog box.

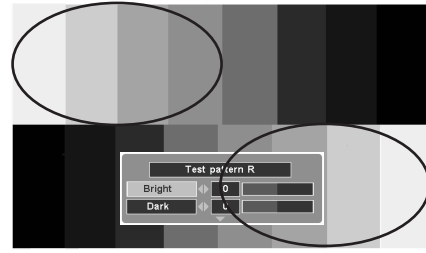

2. Adjust the dark parts with the Dark dialog box.

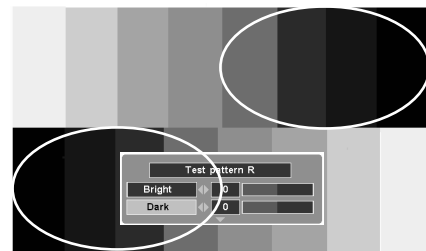

3. Then adjust the Test pattern G and Test pattern B in the same way.

4. Check the adjustment with Check pattern screen.



Factory default

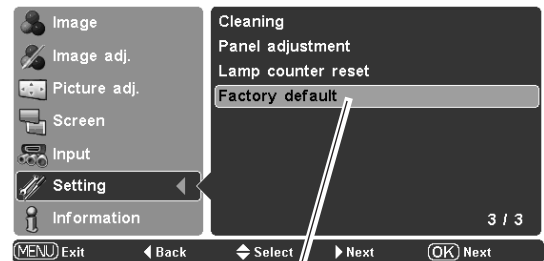

Select Factory default and press the OK or Point ► buttons. "Return to Factory default?" will appear.

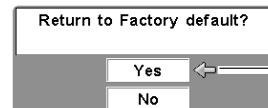

Select [Yes] and press the OK or Point ► buttons, then another confirmation box will appear.

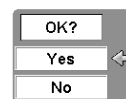

Select [Yes] again to restore to the factory default settings.

Input Source Information Display

This is used for checking the status of the image signal being projected and the operation of the projector.

Signal

Video or S-video A color system of the connected video signal is displayed from among PAL, SECAM, NTSC, NTSC4.43, PAL-M, PAL-N.

Component A system mode of the connected video signal is displayed from among 480i, 480p, 575i, 575p, 720p, 1080i.

HDMI A system mode of the connected video signal is displayed from among D-VGA, D-480i, D-480p, D-575i, D-575p, D-720p, D-1080i.

PC A resolution of the connected computer signal is displayed.

No signal When there is no signal input, "----" is displayed.

Out of recognition When the connected input source is out of recognition, "Unknown" is displayed.

H-sync freq.

The horizontal frequency of the input signal is displayed in KHz, or "----" when no signal.

V-sync freq.

The vertical frequency of the input signal is displayed in Hz, or "----" when no signal.

Lamp Time

The cumulative lamp operating time is displayed.

Information Menu

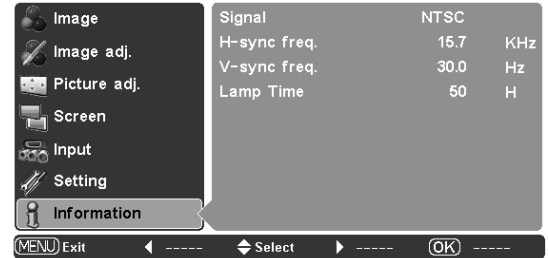

Maintenance and Cleaning

Warning Indicator

The WARNING indicator shows the state of the function that protects the projector. Check the state of the WARNING indicator and the POWER indicator to take proper maintenance.

The projector is shut down and the WARNING indicator is blinking red.

When the temperature inside the projector reaches a certain level, the projector will be automatically shut down to protect its inside. The POWER indicator is blinking while the projector is being cooled down. When the projector has cooled down sufficiently (to its normal operating temperature), it can be turned on again by pressing the POWER ON-OFF button.

✓ **Note:**

- The WARNING indicator continues to blink even after the temperature inside the projector returns to normal. When the projector is turned on again, the WARNING indicator stops blinking.

Then check the items below.

- Did you provide appropriate space for the projector to be ventilated? Check the installing condition to see if ventilation slots are not blocked.
- Is the projector not installed near the ventilation duct of air-conditioning equipment that may be hot? Install the projector away from the ventilation duct of air-conditioning equipment.
- Are the air filters clean? Clean the air filters periodically or replace it with a new one.

The projector is shut down and the WARNING indicator emits a red light.

When the projector detects an abnormal condition, it will be automatically shut down to protect its inside and the WARNING indicator will be red. In this case, unplug the AC power cord and reconnect it, and then turn on the projector once again for check. If the projector cannot be turned on and the WARNING indicator emits a red light, unplug the AC power cord and contact the service station for a checkup and repair.



CAUTION

DO NOT LEAVE THE PROJECTOR WITH THE AC POWER CORD CONNECTED UNDER THE ABNORMAL CONDITION. IT MAY RESULT IN A FIRE OR ELECTRIC SHOCK.

TOP CONTROL

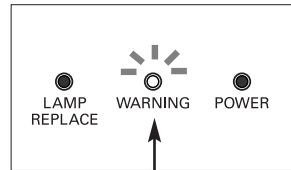

WARNING
blinking red

TOP CONTROL

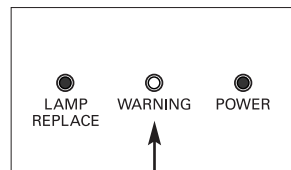

WARNING
emitting a red light

Cleaning the RGB panels

Blemishes such as dust and dirt on the internal optical components of the projector tend to degrade the brightness of the screen and are likely to appear as a shadow on the screen, which can lead to deterioration of image quality.

This projector is equipped with the RGB panel cleaning holes on the underside for cleaning of the internal parts (such as optical components) of the projector. When you use the projector for a lengthy period of time or a shadow of dust appears on the projected screen, clean the inside of the projector.

Using the supplied air blower and with the Cleaning function in the Setting Menu (p.38), you can remove the dusts from the projector.

✓ **Note:**

- Dust might not be removed completely with these steps. In that case, contact the dealer where you purchased the projector or service center.



CAUTION



PROHIBITED

CAUTION IN USING THE AIR BLOWER AND THE NOZZLE

- Turn the projector over when using the blower.
- Use only the supplied air blower and nozzle to keep the projector from being out of order or damaged. We could not guarantee the malfunction or breakage caused by other tools.
- Never use a commercially available compressed air duster. It causes the interior of the projector to malfunction with release of cold liquid propellant.
- Put the projector on a soft cloth to prevent scratching the surface.
- Open the hole cover only when you clean the inside of the projector.
- Do not look into the holes. A strong light could damage your eyes. (Do not look into the Air intake vent and Exhaust vent, either.)
- Use the blower and nozzle only to clean the projector. Do not attempt to use them for other purposes. Do not use the blower and nozzle against persons (particularly to eyes, mouth or ear, and so on). Be especially careful to ensure that children do not put the blower and nozzle into their mouth and swallow them.
- Do not attempt to pull the nozzle out of the blower. If the nozzle happened to be pulled out, put it back into the blower immediately.
- Do not use the blower supplied with this projector (Z4) to clean the Z3 and Z1X.

In the unlikely event that something goes wrong (smoke, a strange sound, an abnormal odor, and such) while you are cleaning, turn off and unplug the projector immediately, then call the dealer where you purchased the projector or service center.

If the nozzle is pulled out

The nozzle has the stopper. Put the stopper-side of the nozzle into the blower. Put the nozzle firmly into the blower until the stopper becomes invisible.

When putting the nozzle into the blower, hold near the stopper so that it will not break.

Make sure not to attempt to pull the nozzle out of the blower.

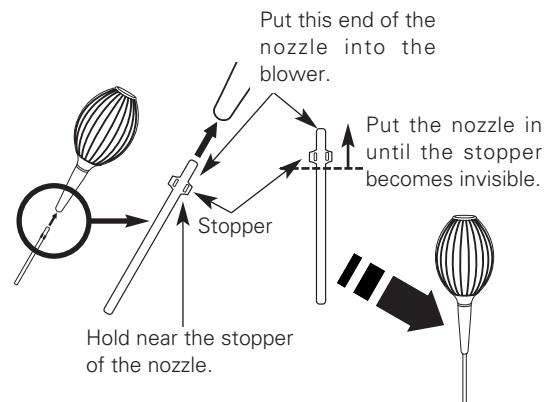

Clean by using the Cleaning function in the Setting Menu

- 1 Turn the projector on and press the MENU button to display the On-Screen Menu. Select the Setting Menu with the Point ▲▼ buttons. Press the Point ► or OK buttons to access the sub-menu items.
- 2 Select Cleaning and then press the OK or Point ► buttons. The screen is blacked out temporarily.
- 3 Turn the projector over. Loosen the screw that secures the hole cover, and then open the hole cover.
- 4 Put the blower's nozzle into a hole.
- 5 Blow air into the projector with the blower watching the position of the dust from the screen.
- 6 When cleaning is done, pull the blower out of the hole and replace the hole cover and secure it with the screw.
- 7 Set the projector back into the right position, then press any button on the top control or on the remote control to quit the Cleaning function.

* Do not open the hole cover except when you clean the inside of the projector to prevent foreign matters from getting into the projector. If it is open especially while operating the projector, the optical parts could damage.

Which hole to put the nozzle in?

When you look at the screen:

- When red spots (dust) are particularly noticeable, put the nozzle into the R panel cleaning holes.
- When green spots (dust) are particularly noticeable, put the nozzle into the G panel cleaning holes.
- When blue spots (dust) are particularly noticeable, put the nozzle into the B panel cleaning holes.

Cleaning

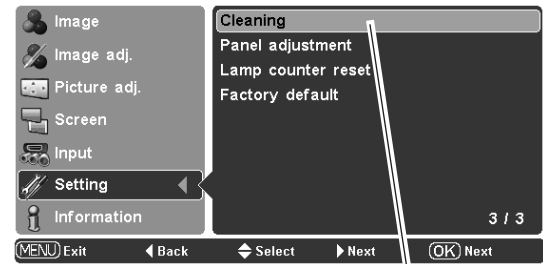

Select Cleaning in the Setting Menu.

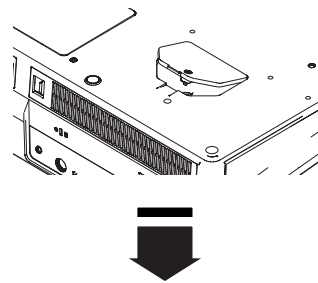

Loosen the screw that secures the hole cover.

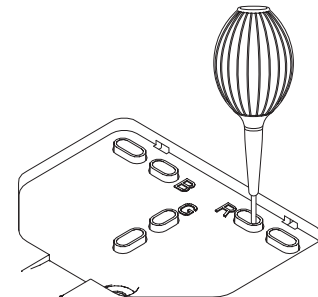

The nozzle will go no further than a certain point when it is put into the hole. Do not attempt to push the nozzle further in, or it could break and be stuck inside of the projector.

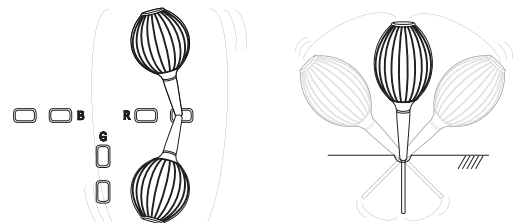

Wave the nozzle back and forth inside of the projector. (Do not attempt to bend the nozzle.)



Use only the supplied blower and nozzle. Do not use a commercially available compressed air duster. It causes the interior of the projector to malfunction with release of cold liquid propellant. We could not guarantee the malfunction of breakage by using other tools.

Cleaning the Air Filters

The air filters prevent dust from accumulating on the surface of the optical elements inside the projector. Should the air filters become clogged with dust particles, it will reduce cooling fans' effectiveness and may result in a buildup of internal heat and adversely affect the life of the projector. Clean the air filters by following the steps below.

Cleaning the Air Filter 1 and 2

- 1** Press the latch and release it. Take off the filter covers. Do not try to pull the delicate filter part.
- 2** Pull out the air filters.
When taking out the Air Filter 2, put your finger on the air filter's tab and pull.
- 3** Remove dust and dirt with a soft brush or a vacuum cleaner. Be careful not to damage the air filters and do not clean them with water.
When the Air Filter 1 gets dusty and dirty, replace it with a new one. For ordering the replacement filter, contact your sales dealer.
- 4** Put the air filters back into the position and close the filter covers. Do not push the delicate filter part. Make sure that the air filters are properly and fully inserted.



CAUTION

Do not operate the projector with the air filters removed. Dust may accumulate on the LCD panel degrading the picture quality of the projection mirror. Do not put anything into the air intake vents. It may result in malfunction of the projector.

RECOMMENDATION

We recommend avoiding dusty/smoky environments when operating the projector. Usage in these environment may cause a poor image quality.

When using the projector under dusty or smoky conditions, dust may accumulate on a lens, LCD panels, or optical elements inside the projector degrading the quality of a projected image.

When the symptoms above are noticed, contact your authorized dealer or service station for proper cleaning.

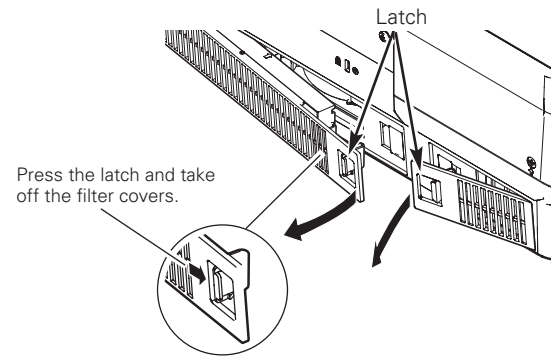
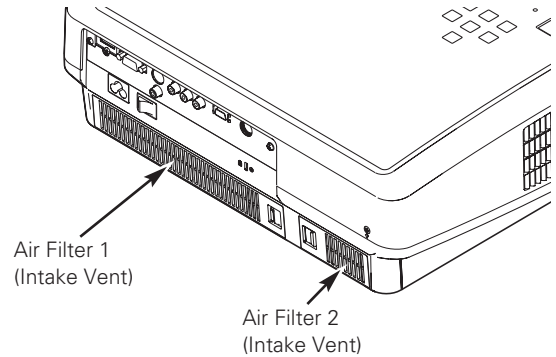

Pull out the air filters.

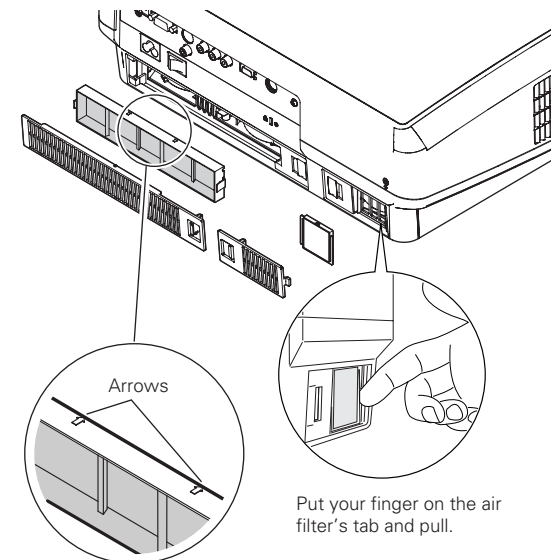

When putting back this air filter, make sure that the arrows on the filter are facing towards the projector.

Cleaning the Projection Lens

Unplug the AC power cord before cleaning.

Gently wipe the projection lens with a cleaning cloth that contains a small amount of non-abrasive camera lens cleaner, or use a lens cleaning paper or a commercially available air blower to clean the lens. Avoid using an excessive amount of cleaner. Abrasive cleaners, solvents, or other harsh chemicals might scratch the surface of the lens.

When the projector is not in use, make sure that the automatic slide shutter is closed.

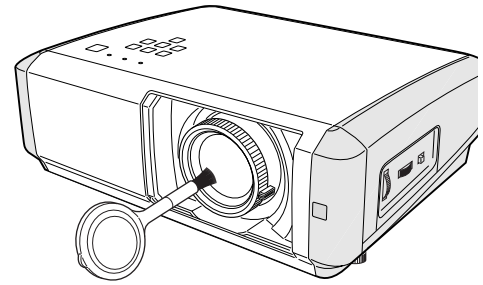

Cleaning the Projector Cabinet

Unplug the AC power cord before cleaning.

Gently wipe the projector body with a dry soft cloth. When the cabinet is heavily soiled, apply a small amount of mild detergent and finish with a dry soft cloth. Avoid using an excessive amount of cleaner. Abrasive cleaners, solvents, or other harsh chemicals might scratch the surface of the cabinet.

When the projector is not in use, put it in an appropriate carrying case to protect it from dust and scratches.

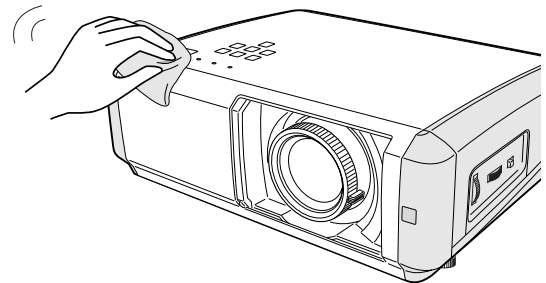

Lamp Replacement

When the life of the projection lamp of this projector draws to an end, the LAMP REPLACE indicator emits a yellow light. If this indicator lights yellow, replace the lamp with a new one promptly.

The time when the LAMP REPLACE indicator should light is depending on the lamp mode.

This indicator lights yellow when the life of the projection lamp draws to an end.

Top Control



CAUTION

Allow the projector to cool, for at least 45 minutes before you open the lamp cover. The inside of the projector can become very hot.



CAUTION

For continued safety, replace the lamp with the same type. Do not drop the lamp or touch the glass bulb! The glass can shatter and may cause injury.

Follow these steps to replace the lamp.

- 1** Turn off the projector and unplug the AC power cord. Allow the projector to cool for at least 45 minutes.
- 2** Turn the projector over. Loosen the screw that secures the lamp cover, and then open the lamp cover.
- 3** Loosen the two (2) screws that secure the lamp. Lift the lamp out of the projector by using the built in handle.
- 4** Replace the lamp with a new one and secure it with the two (2) screws. Make sure that the lamp is set properly. Replace the lamp cover and secure it with the screw.
- 5** Connect the AC power cord to the projector and turn on the projector.
- 6** **Reset the Lamp replacement counter.**
See "Lamp Replacement Counter" on the next page.

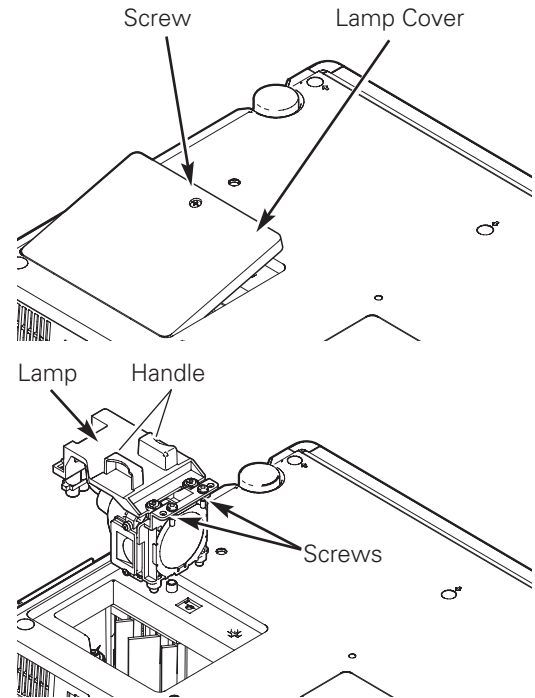

ORDER REPLACEMENT LAMP

Replacement lamp can be ordered through your dealer. When ordering a projection lamp, give the following information to the dealer.

- **Model No. of your projector** : **PLV-Z4**
- **Replacement Lamp Type No.** : **POA-LMP94**
(Service Parts No. 610 323 5998)

Lamp Replacement Counter

Be sure to reset the lamp replacement counter after the lamp is replaced. When the lamp replacement counter is reset, the LAMP REPLACE indicator stops lighting.

- 1 Turn the projector on and press the MENU button to display the On-Screen Menu. Select the Setting Menu with the Point ▲▼ buttons. Press the Point ► button to access the sub-menu items.
- 2 Select Lamp counter reset and then press the the OK or Point ► buttons. "Lamp replacement counter reset?" will appear. Select [Yes] and then press the OK or Point ► buttons.
- 3 Another confirmation dialog box appears, and select [Yes] to reset the Lamp replacement counter.

✓ **Note:**

- Do not reset the Lamp replacement counter without implementing lamp replacement. Be sure to reset the Lamp replacement counter only after replacing the lamp.

Lamp counter reset

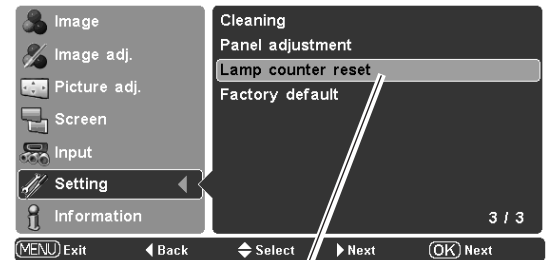

Select Lamp counter reset and press the OK or Point ► buttons. "Lamp replacement counter reset" will appear.

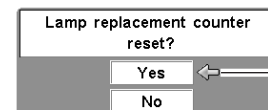

Select [Yes] and press the OK or Point ► buttons, then another confirmation box will appear.



Select [Yes] again to reset the lamp counter.



LAMP HANDLING PRECAUTIONS

This projector uses a high-pressure lamp which must be handled carefully and properly. Improper handling may result in accidents, injury, or create a fire hazard.

- Lamp lifetime may differ from lamp to lamp and according to the environment of use. There is no guarantee of the same lifetime for each lamp. Some lamps may fail or terminate their lifetime in a shorter period of time than other similar lamps.
- If the projector indicates that the lamp should be replaced, i.e., if the LAMP REPLACE indicator lights up, replace the lamp with a new one IMMEDIATELY after the projector has cooled down. (Follow carefully the instructions in the Lamp Replacement section of this manual.) Continuous use of the lamp with the LAMP REPLACE indicator lighted may increase the risk of lamp explosion.
- A Lamp may explode as a result of vibration, shock or degradation as a result of hours of use as its lifetime draws to an end. Risk of explosion may differ according to the environment or conditions in which the projector and lamp are being used.

IF A LAMP EXPLODES, THE FOLLOWING SAFETY PRECAUTIONS SHOULD BE TAKEN.

If a lamp explodes, disconnect the projector's AC plug from the AC outlet immediately. Contact an authorized service station for a checkup of the unit and replacement of the lamp. Additionally, check carefully to ensure that there are no broken shards or pieces of glass around the projector or coming out from the cooling air circulation holes. Any broken shards found should be cleaned up carefully. No one should check the inside of the projector except those who are authorized trained technicians and who are familiar with projector service. Inappropriate attempts to service the unit by anyone, especially those who are not appropriately trained to do so, may result in an accident or injury caused by pieces of broken glass.

Troubleshooting

Before calling your dealer or service center for assistance, check the items below once again.

- Make sure you have properly connected the projector to peripheral equipment as described in “Connecting to Video Equipment” and “Connecting to a Computer” on pages 16 ~ 17.
- Make sure all equipment is connected to an AC outlet and the power is turned on.
- When you operate the projector with a computer and it does not project an image, restart the computer.

Problem:	Solutions
No power.	<ul style="list-style-type: none">– Plug the power cord of the projector into an AC outlet.– See if the automatic slide shutter is only half-open. When it is half-open, the POWER indicator blinks orange and the projector cannot be turned on. (See page 18.)– See if the Main On/Off switch is on.– Wait 60 seconds after the projector is turned off to restart the projector. The projector can be turned on after the POWER indicator turns red. (See page 19.)– Check the WARNING indicator. If the WARNING indicator lights red, the projector cannot be turned on. (See page 41.)– Check the projection lamp. (See page 46)– Check if the projector is installed on a flat surface.
Image is out of focus.	<ul style="list-style-type: none">– Adjust the focus of the projector. (See page 22.)– Provide proper distance between the projector and the projection screen. (See page 13.)– Check the projection lens to see if it needs cleaning. (See page 45.)– Moving the projector from a cool to warm place may result in moisture condensation on the projection lens. In such cases, leave the projector off and wait until condensation evaporates.
No image.	<ul style="list-style-type: none">– Check the connection between your computer or video equipment and the projector. (See page 16 ~ 17.)– See if the input signal is correctly output from your computer. For some laptop computers, the setting for the monitor output needs to be changed when connecting to a projector. See your computer’s instruction manual for the setting.– It takes about 20 seconds to display an image after turning on the projector.– See if the selected system is corresponding to your computer or video equipment. (See page 24 ~ 26.)– Select a correct input source once again through Menu operation. (See page 25 ~ 26.)– Make sure the temperature is not out of the specified Operating Temperature (41°F ~ 95°F (5°C ~ 35°C)).
Image is Left/Right reversed. Image is Top/Bottom reversed.	<ul style="list-style-type: none">– Check the Mounting/Rear item. (See page 36.)– Check the Mounting item. (See page 36.)
Some displays are not seen during operations.	<ul style="list-style-type: none">– Check the Display item. (See page 36.)
The Remote Control does not work.	<ul style="list-style-type: none">– Check the batteries.– Make sure there is no obstruction between the projector and remote control.– Make sure you are not too far from the projector when using the remote control. Maximum operating range is 16.4' (5 m).– Make sure the code of the remote control is conformed to that of the projector. (See page 38.)
Horizontal line noise occurs.	<ul style="list-style-type: none">– For the connection between HDTV equipment and projector’s COMPONENT 1/2 terminals, horizontal line noise may be noted only occasionally. In this case, adjust the value of <i>Fine sync</i>. The factory default value is “10”. (See page 32.)































WARNING:

High voltages are used to operate this projector. Do not attempt to open the cabinet.

If problems still persist after following all operating instructions, contact the dealer where you purchased the projector or service center. Give the model number and explain about the problem. We will advise you how to obtain service.

Indicators and Projector Condition

Check the indicators for projector's condition.

Indicators			Projector Condition
POWER red/green/ orange	WARNING red	LAMP REPLACE yellow	
			The Main On/Off switch is off or the AC power cord is unplugged.
			The projection lamp is being cooled down. The projector cannot be turned on until cooling is completed.
			The projector is ready to be turned on with the POWER ON-OFF button.
			The projector is operating normally.
			The projector is in the Power management mode.
			The temperature inside the projector is abnormally high. The projector cannot be turned on. When the projector is cooled down enough and the temperature returns to normal, the POWER indicator emits a red light and the projector can be turned on. (The WARNING indicator keeps blinking.) Check and clean the air filters.
			The projector has been cooled down enough and the inside temperature returns to normal. When turning on the projector, the WARNING indicator stops blinking. Check and clean the air filters.
			The projector detects an abnormal condition and cannot be turned on. Unplug the AC power cord and plug it again to turn on the projector. If the projector is turned off again, unplug the AC power cord and contact the dealer or service center for servicing and checkup. Do not leave the projector on. It may cause an electric shock or a fire hazard.
			The lamp does not turn on because malfunction occurs or the lamp life comes to an end.
			The automatic slide shutter is not working properly.

 ••• green

 ••• blinking green

 ••• blinking orange

 ••• off

 ••• red

 ••• blinking red

 ••• blinking yellow

* When the life of the projection lamp draws to an end, the LAMP REPLACE indicator lights yellow. When this indicator becomes yellow, replace the projection lamp with a new one promptly. Reset the Lamp replacement counter after replacing the lamp. The time when the LAMP REPLACE indicator should light is depending on the lamp mode. See pages 46 and 47.

Menu Tree

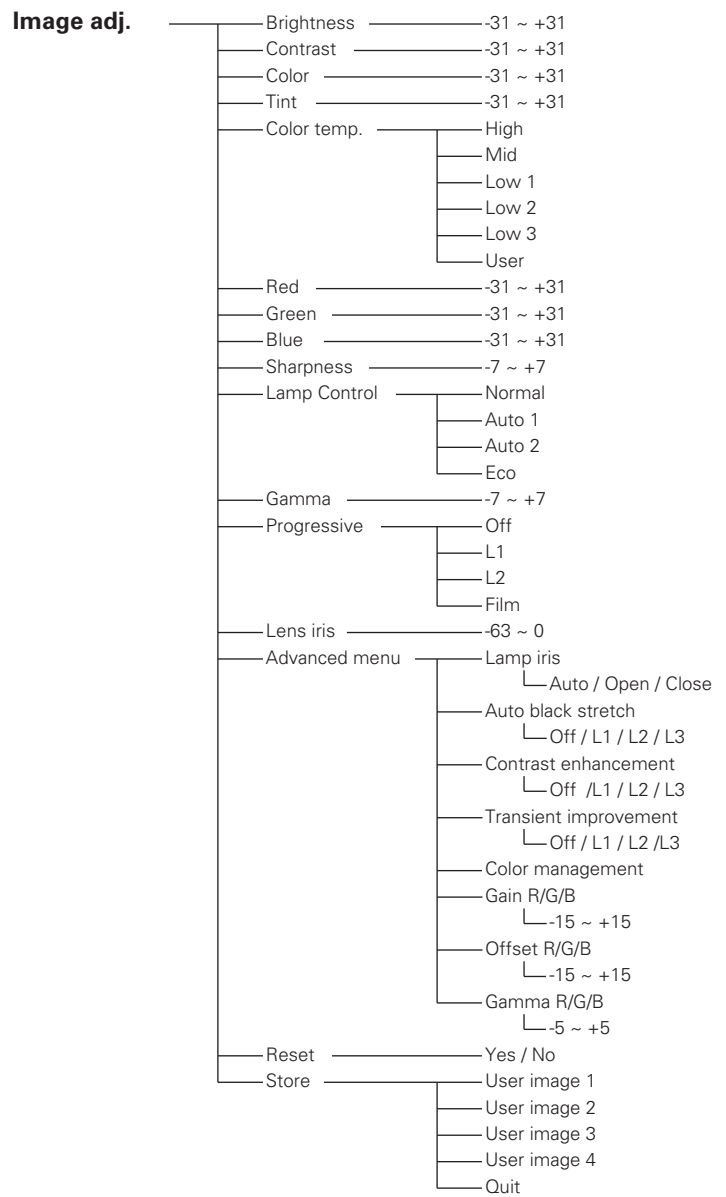
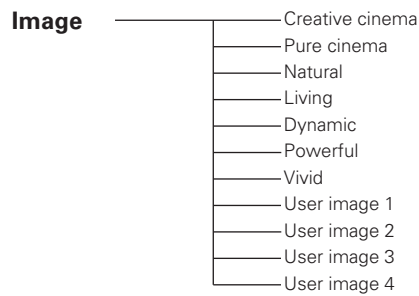
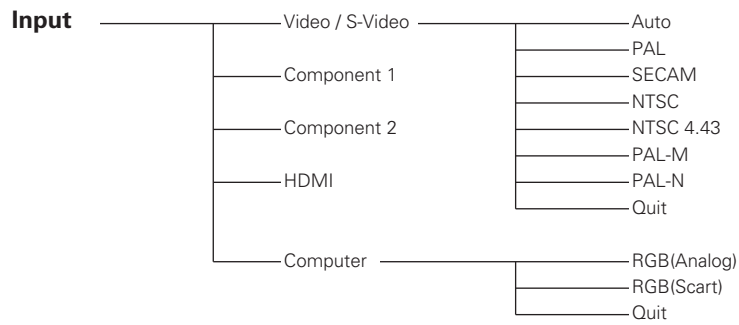

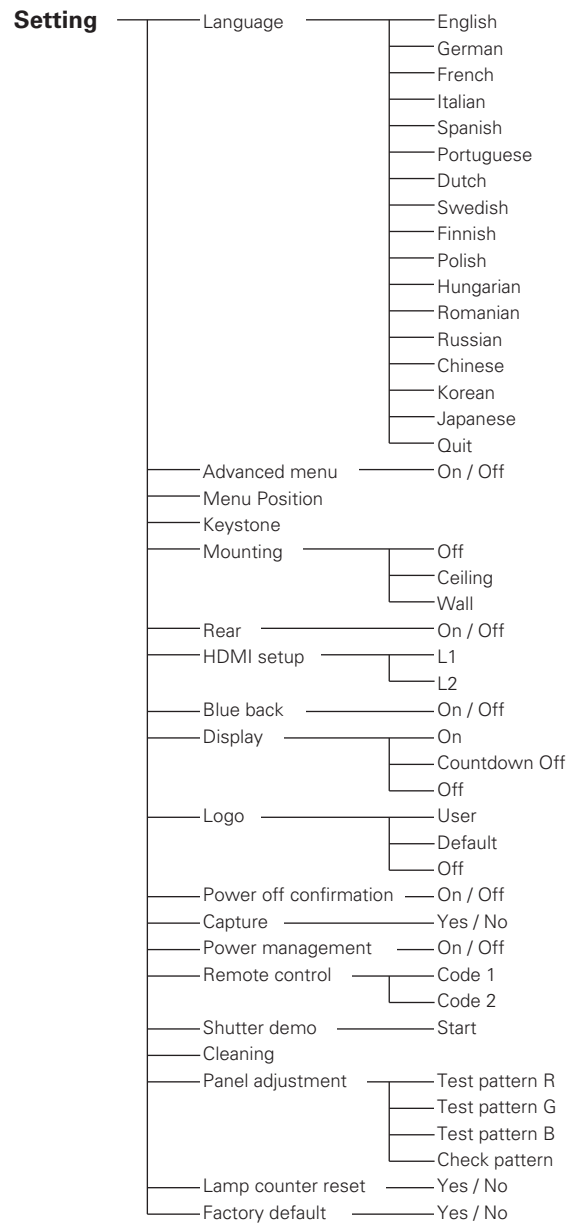
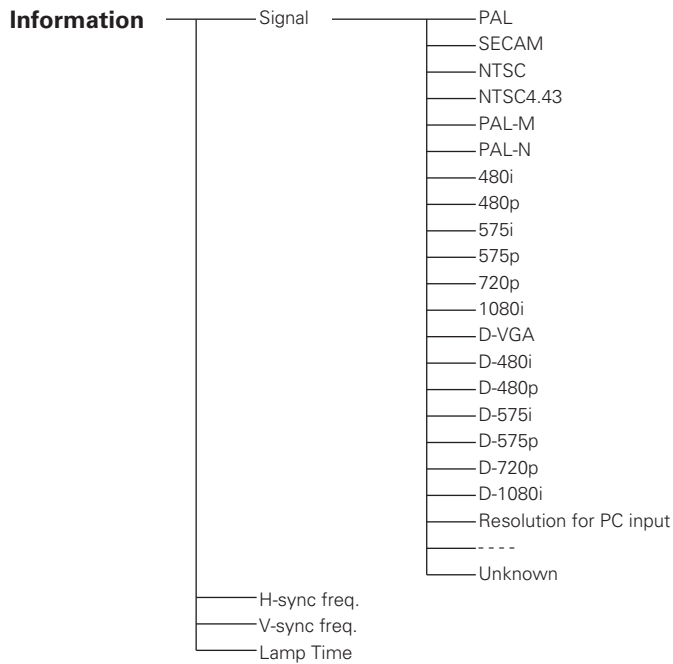
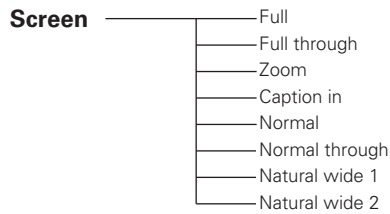
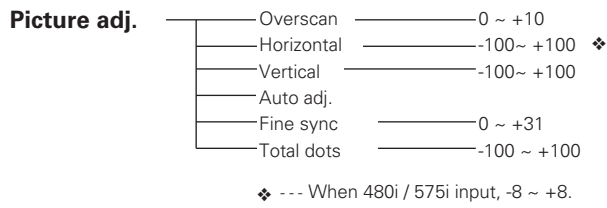

Compatible Computer Specifications

PLV-Z4 can basically accept the signal from all computers with V, H-Frequency mentioned below and less than 100 MHz of Dot Clock.

System mode	H-Freq. (kHz)	V-Freq. (Hz)
640 x 480	31.47	59.88
640 x 480	37.86	74.38
640 x 480	37.85	72.81
640 x 480	37.50	75.00
640 x 480	43.269	85.00
640 x 400	37.861	85.08
640 x 480	35.00	66.67
720 x 400	37.927	85.039
800 x 600	35.156	56.25
800 x 600	37.88	60.32
800 x 600	46.875	75.00
800 x 600	53.674	85.06
800 x 600	48.08	72.19
800 x 600	37.90	61.03
800 x 600	34.50	55.38
800 x 600	38.60	60.31
800 x 600	47.90	71.92
800 x 600	32.70	51.09
832 x 624	49.72	74.55
848 x 480	31.020	60.00
1024 x 768	48.35	60.00
1024 x 768	68.677	84.997
1024 x 768	60.023	75.03
1024 x 768	56.47	70.07

System mode	H-Freq. (kHz)	V-Freq. (Hz)
1024 x 768	60.31	74.92
1024 x 768	44.00	54.58
1024 x 768	63.48	79.35
1024 x 768	62.04	77.07
1024 x 768	61.00	75.70
1024 x 768	46.90	58.20
1024 x 768	58.03	72.00
1152 x 864	64.20	70.40
1152 x 870	68.68	75.06
1152 x 900	61.20	65.20
1152 x 900	61.85	66.00
720p	45.00	60.00
1080i	33.75	30.00 (Interlace)
1080i	28.12	25.00 (Interlace)

When the input signal is digital from the HDMI terminal, refer to the chart below.

System mode	RESOLUTION	H-Freq. (kHz)	V-Freq. (Hz)
D-VGA	640 x 480	—	59.94/60
D-480i	720 x 480	—	59.94/60
D-575i	720 x 575	—	50.00
D-480p	720 x 480	—	59.94/60
D-575p	720 x 575	—	50.00

System mode	RESOLUTION	H-Freq. (kHz)	V-Freq. (Hz)
D-720p	1280 x 720	—	59.94/60
D-720p	1280 x 720	—	50.00
D-1080i	1920 x 1080	—	59.94/60
D-1080i	1920 x 1080	—	50.00

✓ Note:

- You might be able to project images even when signals other than above are inputted, however the functions of the projector could be limited.

Technical Specifications

Projector Type	Multimedia Projector
Dimensions (W x H x D)	15.04" x 4.99" x 11.98" (382 mm x 126.8 mm x 304.3 mm) (not including raised portions)
Net Weight	10.2 lbs (5.0 kg)
LCD Panel System	0.7" wide TFT Active Matrix type, 3 panels
Panel Resolution	1280 x 720 dots
Number of Pixels	2,764,800 (1280 x 720 x 3 panels)
Color System	PAL, SECAM, NTSC, NTSC4.43, PAL-M, and PAL-N
High Definition TV Signal	480i, 480p, 575i, 575p, 720p and 1080i
Scanning Frequency	H-sync. 15 ~ 80 KHz, V-sync. 50 ~ 100 Hz
Projection Image size (Diagonal)	Adjustable from 40" to 300"
Projection Lens	F 2.0 ~ 3.0 lens with f 21.3 mm ~ 42.6 mm with manual zoom and focus
Throw Distance	3.9' ~ 30.2' (1.2 m ~ 9.2 m)
Projection Lamp	145 W
Video Input Jacks	RCA Type x 1 (Video), RCA Type x 3 (Y, Pb/Cb, Pr/Cr) x 2 and Mini DIN 4 pin x 1 (S-video)
Computer Input Terminal	(VGA) HDB 15 Terminal x 1
HDMI Input Terminal	HDMI terminal 19 pin x 1
Service Port Connector	Mini DIN 8 pin x 1
Feet Adjustment	0° to 7.7°
Voltage and Power Consumption	AC 100 ~ 120 V (2.4 A Max. Ampere), 50/60 Hz (The U.S.A. and Canada) AC 200 ~ 240 V (1.3 A Max. Ampere), 50/60 Hz (Continental Europe and The U.K.)
Operating Temperature	41 °F ~ 95 °F (5 °C ~ 35 °C)
Storage Temperature	14 °F ~ 140 °F (-10 °C ~ 60 °C)
Remote Control	Power Source : AA or LR06 1.5V ALKALINE Type x 2 Operating Range : 16.4' (5 m) / ± 30° Dimensions : 1.57" x 1.44" x 5.12" (40 mm x 36.5 mm x 130 mm) Net Weight : 3.6 oz (102 g) (including batteries)
Accessories	Owner's Manual AC Power Cord Remote Control and Batteries Video Cable Air Blower

- The specifications are subject to change without notice.
- LCD panels are manufactured to the highest possible standards. Even though 99.99% of the pixels are effective, a tiny fraction of the pixels (0.01% or less) may be ineffective by the characteristics of the LCD panels.



This symbol on the nameplate means the product is Listed by Underwriters Laboratories Inc. It is designed and manufactured to meet rigid U.L. safety standards against risk of fire, casualty and electrical hazards.



The CE Mark is a Directive conformity mark of the European Community (EC).



Pixelworks ICs used.

Dimensions

Unit : inch (mm)

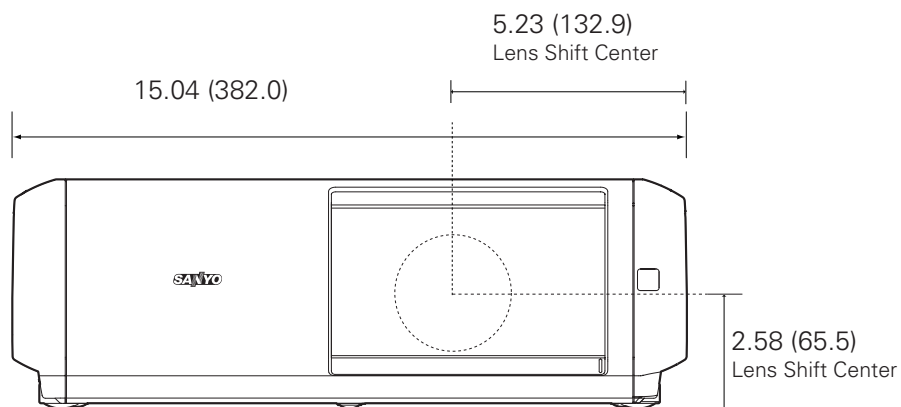

7.7° (Max.)

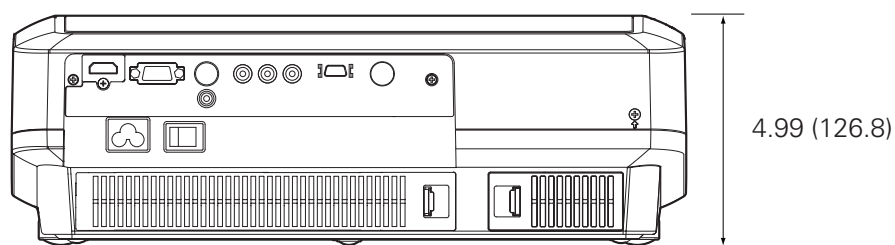
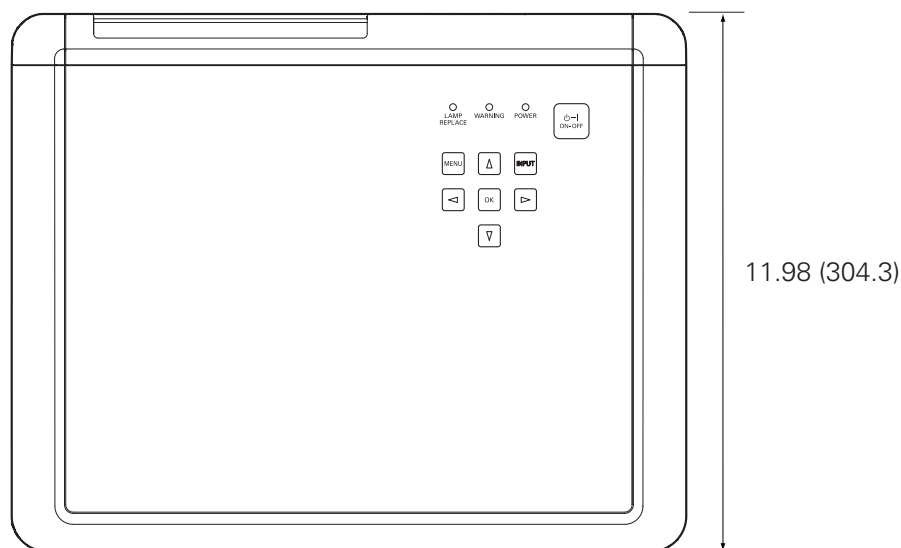
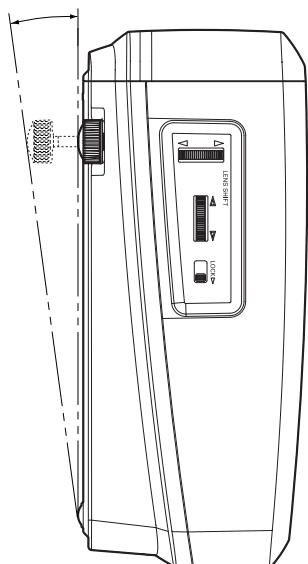

Configurations of Terminals

Video terminal

Terminal : HDMI

Pin Configuration

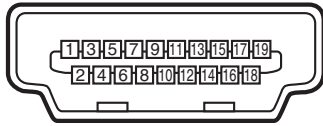

19 Pin Type A

1	TMDS Data 2+ Input	11	Ground (TMDS Clock)
2	Ground (TMDS Data 2)	12	TMDS Clock- Input
3	TMDS Data 2- Input	13	----
4	TMDS Data 1+ Input	14	----
5	Ground (TMDS Data 1)	15	SCL
6	TMDS Data 1- Input	16	SDA
7	TMDS Data 0+ Input	17	Ground(DDC/CEC)
8	Ground (TMDS Data 0)	18	+5V Power
9	TMDS Data 0- Input	19	Plug insert detection
10	TMDS Clock+ Input		

Computer terminal

Terminal : VGA

Pin Configuration

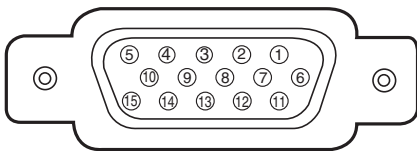

1	Red Input	9	----
2	Green Input	10	Ground (Vert.sync.)
3	Blue Input	11	Ground / ----
4	----	12	----
5	Ground (Horiz.sync.)	13	Horiz. sync. Input/Output (Composite H/V sync.)
6	Ground (Red)	14	Vert. sync.
7	Ground (Green)	15	----
8	Ground (Blue)		

Optional Parts

The parts listed below are optionally supplied. When ordering those parts, give the name and Type No. to the sales dealer.

- Wall Anchor Kit

Type No. : POA-CH-EX02

- HDMI Cable

Type No. : POA-CA-HDMI

- Component Cable (32.8'/10m)

Type No. : POA-CA-COMP10

- Scart-VGA Cable

Type No. : POA-CA-SCART

(This cable is used for RGB Scart 21-Pin Video output of video equipment.)

