

Panasonic®

Operating Instructions

LCD Projector

Model No. **PT-AE2000U**

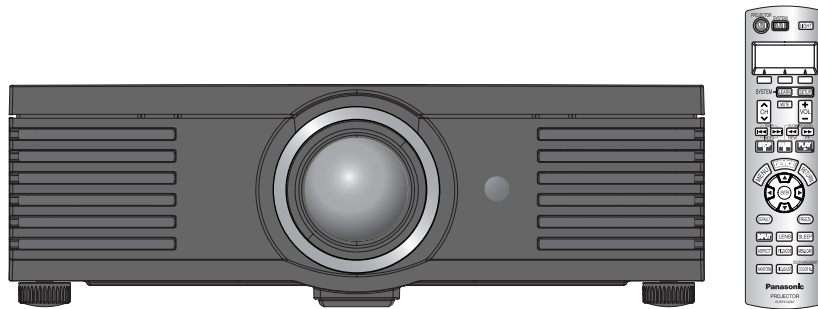

HDMI™
HIGH-DEFINITION MULTIMEDIA INTERFACE

Before operating this product, please read the instructions carefully and save this manual for future use.

TQBJ0233

Important Safety Notice

Dear Panasonic Customer:

The following information should be read and understood as it provides details, which will enable you to operate the projector in a manner which is both safe to you and your environment, and conforms to legal requirements regarding the use of projectors. Before connecting, operating or adjusting this projector, please read these instructions completely and save this booklet with the projector for future reference. We hope it will help you to get the most out of your new product, and that you will be pleased with your Panasonic LCD projector.

The serial number of your product may be found on its bottom. You should note it in the space provided below and retain this booklet in case service is required.

Model number: **PT-AE2000U**

Serial number:

WARNING: TO REDUCE THE RISK OF FIRE OR ELECTRIC SHOCK, DONOT EXPOSE THIS PRODUCT TO RAIN OR MOISTURE.

Power Supply: This LCD Projector is designed to operate on 100 V - 240 V, 50 Hz/60 Hz AC, house current only.

CAUTION: The AC power cord which is supplied with the projector as an accessory can only be used for power supplies up to 125 V, 7 A. If you need to use higher voltages or currents than this, you will need to obtain a separate 250 V power cord. If you use the accessory cord in such situations, fire may result.



The lightning flash with arrowhead symbol, within an equilateral triangle, is intended to alert the user to the presence of uninsulated "dangerous voltage" within the product's enclosure that may be of sufficient magnitude to constitute a risk of electric shock to persons.



The exclamation point within an equilateral triangle is intended to alert the user to the presence of important operating and maintenance (servicing) instructions in the literature accompanying the product.

CAUTION: This equipment is equipped with a three-pin grounding-type power plug. Do not remove the grounding pin on the power plug. This plug will only fit a grounding-type power outlet. This is a safety feature. If you are unable to insert the plug into the outlet, contact an electrician. Do not defeat the purpose of the grounding plug.

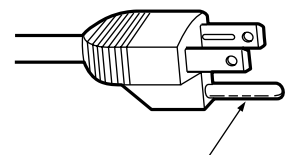

Do not remove

NOTICE: This product has a High Intensity Discharge (HID) lamp that contains mercury. Dispose may be regulated in your community due to environmental considerations. For disposal or recycling information, please contact your local authorities, or the Electronic Industries Alliance: <http://www.eiae.org>

WARNING:

This equipment has been tested and found to comply with the limits for a Class B digital device, pursuant to Part 15 of the FCC Rules. These limits are designed to provide reasonable protection against harmful interference in a residential installation. This equipment generates, uses and can radiate radio frequency energy and, if not installed and used in accordance with the instructions, may cause harmful interference to radio communications. However, there is no guarantee that interference will not occur in a particular installation. If this equipment does cause harmful interference to radio or television reception, which can be determined by turning the equipment off and on, the user is encouraged to try to correct the interference by one or more of the following measures:

- Reorient or relocate the receiving antenna.
- Increase the separation between the equipment and receiver.
- Connect the equipment into an outlet on a circuit different from that to which the receiver is connected.
- Consult the dealer or an experienced radio/TV technician for help.

FCC CAUTION: To assure continued compliance, use only shielded interface cables when connecting to computers or peripheral devices. Any unauthorized changes or modifications to this equipment will void the users authority to operate.

If you use serial port to connect PC for external control of projector, you must use optional RS-232C serial interface cable with ferrite core. Any unauthorized changes or modifications to this equipment will void the user's authority to operate.

Pursuant to at the directive 2004/108/EC, article 9(2)
Panasonic Testing Center
Panasonic Service Europe, a division of Panasonic Marketing Europe GmbH
Winsbergring 15, 22525 Hamburg, F.R. Germany

WARNING: Not for use in a computer room as defined in the Standard for the Protection of Electronic Computer/Data Processing Equipment, ANSI/NFPA 75.

Declaration of Conformity

Model Number: PT-AE2000U
Trade Name: **Panasonic**
Responsible party: Panasonic Corporation of North America
Address: One Panasonic Way, Secaucus, New Jersey 07094
Telephone number: (888) 411 - 1996

This device complies with Part 15 of the FCC Rules. Operation is subject to the following two conditions: (1) This device may not cause harmful interference, and (2) this device must accept any interference received, including interference that may cause undesired operation.

Information on Disposal in other Countries outside the European Union

This symbol is only valid in the European Union.

If you wish to discard this product, please contact your local authorities or dealer and ask for the correct method of disposal.

Contents

Quick steps

1. Set up your projector
See "Setting up" on page 14.



2. Connect with other devices
See "Connections" on page 18.



3. Prepare the remote control
See "Remote control" on page 11.



4. Start projecting
See "Switching the projector on/off" on page 19.



5. Adjust the image
See "Menu Navigation" on page 28.

Important Information

Important Safety Notice	2
Precautions with regard to safety	6
WARNINGS	6
CAUTIONS	8
Cautions when transporting	9
Cautions when installing	9
Cautions on use	10
Accessories	10

Preparation

About Your Projector	11
Remote control	11
Projector body	12

Getting Started

Setting up	14
Screen size and throw distance	14
Projection method	15
Front leg adjusters and throwing angle	15
Lens shift and positioning	16
Connections	18
Before connecting to the projector	18
Connecting to COMPONENT IN/VIDEO IN/S-VIDEO IN	18
Connecting to COMPUTER IN/HDMI IN	18

Basic Operation

Switching the projector on/off	19
Power cord	19
POWER indicator	19
Switching on the projector	20
Switching off the projector	20
Projecting an image	21
Selecting the input signal	21
Positioning the image	21
Remote control operation	22
Operating range	22
Turning on the button backlight	22
Resetting to the factory default settings	22
Capturing an image	22
Switching the input signal	23
Switching the aspect ratio	23
Loading a saved setting	23
Adjusting the signal condition with a waveform	24
Adjusting the focus and zoom	25
Switching the picture mode	25
Adjusting the image	25
Switching off the projector automatically	25
Setting your own color profile	26

Settings

Menu Navigation	28
Main menu and sub-menu	28
Navigating through the MENU	30
PICTURE menu	31
PICTURE MODE	31
CONTRAST	31
BRIGHTNESS	31
COLOR	31
TINT	31
SHARPNESS	31
COLOR TEMPERATURE	32
DYNAMIC IRIS	32
WAVEFORM MONITOR	32
SPLIT ADJUST	32
ADVANCED MENU	33
MEMORY SAVE	34
MEMORY LOAD	34
MEMORY EDIT	35
SIGNAL MODE	35
POSITION menu	36
H-POSITION	36
V-POSITION	36
DOT CLOCK	36
CLOCK PHASE	36
ASPECT	36
WSS	38
OVER SCAN	38
KEYSTONE	38
AUTO SETUP	38
LENS CONTROL	39
ZOOM/FOCUS	39
FUNCTION BUTTON	39
BUTTON1/2/3	39
OPTION menu	40
INPUT GUIDE	40
OSD DESIGN	40
OSD POSITION	40
BACK COLOR	40
STARTUP LOGO	40
AUTO SEARCH	40
HDMI SIGNAL LEVEL	40
FRAME RESPONSE	40
INSTALLATION	41
SLEEP	41
ALTITUDE	41
LAMP POWER	41
LAMP RUNTIME	41

Maintenance

TEMP and LAMP Indicators	42
Managing the indicated problems	42
Care and Replacement	43
Cleaning the projector	43
Replacing the lamp unit	44
Troubleshooting	46

Appendix

Technical Information	47
List of compatible signals	47
Serial terminal	48
Ceiling mount bracket safeguards	51
Specifications	52
Dimensions	54
Trademark acknowledgements	55
Index	56

Precautions with regard to safety

WARNINGS

If you notice smoke, strange smells or noise coming from the projector, disconnect the power plug from the wall outlet.

- Do not continue to use the projector in such cases, otherwise fire or electric shocks could result.
- Check that no more smoke is coming out, and then contact an Authorized Service Center for repairs.
- Do not attempt to repair the projector yourself, as this can be dangerous.

Do not install this projector in a place which is not strong enough to take the full weight of the projector.

- If the installation location is not strong enough, it may fall down or tip over, and severe injury or damage could result.

Installation work (such as ceiling suspension) should only be carried out by a qualified technician.

- If installation is not carried out correctly, there is the danger that injury or electric shocks may occur.
- Do not use other than an authorized ceiling mount bracket.

If foreign objects or water get inside the projector, or if the projector is dropped or the cabinet is broken, disconnect the power plug from the wall outlet.

- Continued use of the projector in this condition may result in fire or electric shocks.
- Contact an Authorized Service Center for repairs.

Do not overload the wall outlet.

- If the power supply is overloaded (for example, by using too many adapters), overheating may occur and fire may result.

Never attempt to modify or disassemble the projector.

- High voltages can cause fire or electric shocks.
- For any inspection, adjustment and repair work, please contact an Authorized Service Center.

Clean the power plug regularly to prevent it from becoming covered in dust.

- If dust builds up on the power plug, the resulting humidity can damage the insulation, which could result in fire. Pull the power plug out from the wall outlet and wipe it with a dry cloth.
- If not using the projector for an extended period of time, pull the power plug out from the wall outlet.

Do not handle the power plug with wet hands.

- Failure to observe this may result in electric shocks.

Insert the power plug securely into the wall outlet.

- If the plug is not inserted correctly, electric shocks or overheating could result.
- Do not use plugs which are damaged or wall outlets which are coming loose from the wall.

Do not place the projector on top of surfaces which are unstable.

- If the projector is placed on top of a surface which is sloped or unstable, it may fall down or tip over, and injury or damage could result.

Do not place the projector into water or let it become wet.

- Failure to observe this may result in fire or electric shocks.

Do not do anything that might damage the power cord or the power plug.

- Do not damage the power cord, make any modifications to it, place it near any hot objects, bend it excessively, twist it, pull it, place heavy objects on top of it or wrap it into a bundle.
- If the power cord is used while damaged, electric shocks, short-circuits or fire may result.
- Ask an Authorized Service Center to carry out any repairs to the power cord that might be necessary.

Do not place the projector on soft materials such as carpets or sponge mats.

- Doing so may cause the projector to overheat, which can cause burns, fire or damage to the projector.

Do not place liquid containers on top of the projector.

- If water spills onto the projector or gets inside it, fire or electric shocks could result.
- If any water gets inside the projector, contact an Authorized Service Center.

Do not insert any foreign objects into the projector.

- Do not insert any metal objects or flammable objects into the projector or drop them onto the projector, as doing so can result in fire or electric shocks.

Do not allow the + and - terminals of the batteries to come into contact with metallic objects such as necklaces or hairpins.

- Failure to observe this may cause the batteries to leak, overheat, explode or catch fire.
- Store the batteries in a plastic bag and keep them away from metallic objects.

Do not touch the leaked liquid from the batteries.

- If you touch the leaked liquid, it may hurt your skin. Immediately wash away the liquid with water and seek medical advice.
- If you get the leaked liquid in your eye, it may cause blindness or damage. Never rub your eye, and immediately wash away the liquid with water and seek medical advice.

During a thunderstorm, do not touch the projector or the cable.

- Electric shocks can result.

Do not use the projector in a bath or shower.

- Fire or electric shocks can result.

Do not place your skin into the light beam while the projector is being used.

- Strong light is emitted from the projector's lens. If you place directly into this light, it can hurt or damage your skin.

Do not look into the lens while the projector is being used.

- Strong light is emitted from the projector's lens. If you look directly into this light, it can hurt and damage your eyes.
- Be especially careful not to let young children look into the lens. In addition, turn off the power and disconnect the power plug when you are away from the projector.

Do not place your hands or other objects close to the air outlet port.

- Heated air comes out of the air outlet port. Do not place your hands or face, or objects which cannot withstand heat close to this port [allow at least 50 cm (20") of space], otherwise burns or damage could result.

Replacement of the lamp is recommended to be carried out by a qualified technician.

- The lamp has high internal pressure. If improperly handled, explosion might result.
- The lamp can easily become damaged if struck against hard objects or dropped, and injury or malfunctions may result.

When replacing the lamp, allow it to cool for at least one hour before handling it.

- The lamp cover gets very hot, and touching it can cause burns.

Before replacing the lamp, be sure to disconnect the power plug from the wall outlet.

- Electric shocks or explosions can result if this is not done.

Do not allow infants or pets to touch the remote control unit.

- The accessory remote control unit can be used to operate not only the projector but also other appliances such as air conditioners and electrical device by programming them using the learning function. If the remote control unit operated inappropriately, fire or injury may result.
- Keep the remote control unit out of the reach of infants and pets after using it.

Precautions with regard to safety

CAUTIONS

Do not cover the air inlet port or the air outlet port.

- Doing so may cause the projector to overheat, which can cause fire or damage to the projector.
- Do not place the projector in narrow, badly ventilated places such as closets or bookshelves.
- Do not place the projector on cloth or papers, as these materials could be drawn into the air inlet port.

Do not set up the projector in humid or dusty places or in places where the projector may come into contact with oily smoke or steam.

- Using the projector under such conditions may result in fire, electric shocks or plastic deterioration. The plastic deterioration may cause the falling down of the projector which is mounted in the ceiling.

Do not set up the projector in a high temperature environment, such as near a heater or in direct sunlight.

- Failure to observe this may result in fire, malfunction or plastic deterioration.

Do not set up the projector outdoors.

- The projector is designed for indoor use only.

When disconnecting the power cord, hold the plug, not the cord.

- If the power cord itself is pulled, the cord will become damaged, and fire, short-circuits or serious electric shocks may result.

Always disconnect all cables before moving the projector.

- Moving the projector with cables still attached can damage the cables, which could cause fire or electric shocks to occur.

Do not place any heavy objects on top of the projector.

- Failure to observe this may cause the projector to become unbalanced and fall, which could result in damage or injury.

Do not short-circuit, heat or disassemble the batteries or place them into water or fire.

- Failure to observe this may cause the batteries to overheat, leak, explode or catch fire, and burns or other injury may result.

When inserting the batteries, make sure the polarities (+ and -) are correct.

- If the batteries are inserted incorrectly, they may explode or leak, and fire, injury or contamination of the battery compartment and surrounding area may result.

Use only the specified batteries.

- If incorrect or different kind of batteries are used, they may explode or leak, and fire, injury or contamination of the battery compartment and surrounding area may result.

Do not mix old and new batteries.

- If the batteries are inserted incorrectly, they may explode or leak, and fire, injury or contamination of the battery compartment and surrounding area may result.

Remove the used batteries from the remote control promptly.

- If you leave used batteries in the remote control for an extended period of time, it may cause liquid leaking, abnormal internal temperature rising or explosion.

If not using the projector for an extended period of time, disconnect the power plug from the wall outlet and remove the batteries from the remote control.

- If dust builds up on the power plug, the resulting humidity may damage the insulation, which could result in fire.
- Keeping or leaving the remote control with batteries inside may cause insulation deterioration, electrical leakage or explosion which could result in fire.

Do not put your weight on this projector.

- You could fall or the projector could break, and injury may result.
- Be especially careful not to let young children stand or sit on the projector.

Disconnect the power plug from the wall outlet as a safety precaution before carrying out any cleaning.

- Electric shocks can result if this is not done.

If the lamp has broken, ventilate the room immediately. Do not touch or bring your face close to the broken pieces.

- Failure to observe this may cause the user to absorb the gas which was released when the lamp broke and which contains nearly the same amount of mercury as fluorescent lamps, and the broken pieces may cause injury.
- If you believe that you have absorbed the gas or that the gas has got into your eyes or mouth, seek medical advice immediately.
- Ask your dealer about the replacement of the lamp unit and check the inside of the projector.

Ask an Authorized Service Center to clean inside the projector at least once a year.

- If dust is left to build up inside the projector without being cleaned out, it can result in fire or problems with operation.
- It is a good idea to clean the inside of the projector before the season for humid weather arrives. Ask your nearest Authorized Service Center to clean the projector when required. Please discuss with the Authorized Service Center regarding cleaning costs.

We are constantly making efforts to preserve and maintain a clean environment. Please take non repairable units back to your dealer or a recycling company.

Cautions when transporting**Do not subject the projector to excessive vibration or shocks.**

- The projector lens need to be handled with care.
- Cover the lens with the lens cover when transporting the projector.

When transporting the projector, hold the body at the bottom securely.

- Do not hold the adjuster legs or the top cover to move the projector, as this may damage the projector.

Cautions when installing**Avoid setting up in places which are subject to vibration or shocks.**

- The internal parts can be damaged, which may cause malfunctions or accidents.

Avoid setting up in places which are subject to sudden temperature changes, such as near an air conditioner or lighting equipment.

- The life of the lamp may be shortened or the projector may be turned off. See "TEMP indicator" on page 42.

Do not set up the projector near high-voltage power lines or near motors.

- The projector may be subject to electromagnetic interference.

If installing the projector to the ceiling, ask a qualified technician or an Authorized Service Center to carry out all installation work.

- You will need to purchase the separate installation kit (Model No. ET-PKE2000, ET-PKE1000S). Furthermore, all installation work is should only be carried out by a qualified technician.
- See "Ceiling mount bracket safeguards" on page 51 for the safety cable installation.

If using this projector at high elevations (above 1 400 m), set the HIGHLAND to ON. See "ALTITUDE" on page 41.

- Failure to observe this may result in malfunctions or the life of the lamp or the other components may be shortened.

Precautions with regard to safety

Cautions on use

In order to get the best picture quality

- Draw curtains or blinds over any windows and turn off any lights near the screen to prevent outside light or light from indoor lamps from shining onto the screen.

Do not touch the surfaces of the lens with your bare hands.

- If the surface of the lens becomes dirty from fingerprints or anything else, this will be magnified and projected onto the screen. Moreover, when not using the projector, attach the lens cover.

Liquid crystal panel

- Do not project the same image for long periods of time, as this may remain as an afterimage on the liquid crystal panel.
- The liquid crystal panel of the projector is built with very high precision technology to provide fine picture details. Occasionally, a few stuck pixels may appear on the screen as fixed points of blue, green or red. It is recommended to switch off the projector once and try after 1 hour later again. Please note that this does not affect the performance of your LCD.

The projector has a high pressure mercury lamp and that is characterized as follows.

- The brightness of the lamp depends on the duration of use.
- The lamp may explode or shorten the lamp life by shocks or chipping damage.
- The lamp may explode only occasionally after using the projector.
- The lamp may explode if using the projector after the instructed lamp replacement timing.
- The lamp life is depends on individual lamp characteristics, usage condition and the installation environment. Especially the consecutive use of the projector for more than 10 hours, or the frequent switching on or off may greatly affect on the lamp life.

Screen

- Do not apply any volatile substances which may cause discoloration to the screen, and do not let it become dirty or damaged.

Optical components

- If you use the projector consecutively 6 hours every day, the optical components may need to be replaced in less than 1 year.

Accessories

Make sure the following accessories are provided with your projector.

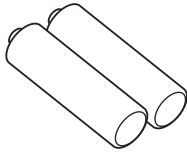
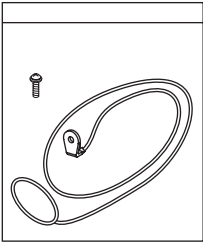
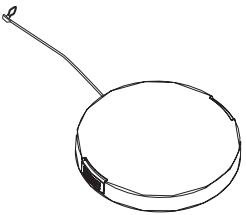
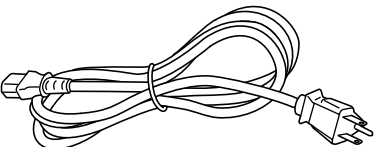
<p>Remote control for PT-AE2000U (x1) EUR7914Z60</p> 	<p>AA batteries for remote control (x2)</p> 	<p>Safety cable TTRA0141 Attachment screw (x1) Safety cable (x1)</p> 	<p>Lens cover (x1) TXFKK01VKF5</p> 
<p>Power cord (x1) K2CG3FZ00008 3 m (9'10")</p> 			

About Your Projector

Remote control

Preparation

POWER button
While the **MAIN POWER** button is on, switch between stand-by mode and projection mode. (page 19)



Display the main menu or return to the previous menu. (page 30)



Navigate through the menus with **▲▼◀▶**, and activate the menu item with **ENTER**. (page 30)

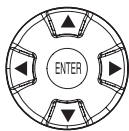

Reset some of the settings to the factory default settings. (page 22)



Battery compartment
1. Press the tab and lift up the cover.
2. Insert the batteries according to the polarity diagram indicated inside.

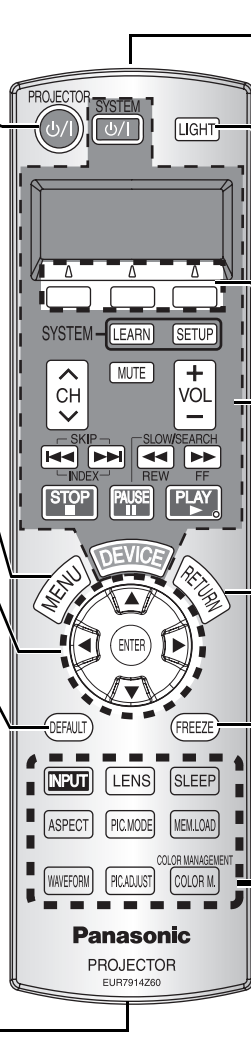
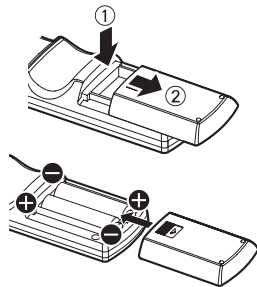

Remote control signal emitter
Remote control signal. (page 22)

LIGHT Turn the button backlight of the remote control on/off. (page 22)

Function buttons
Assign the frequently used functions from the options for shortcut. (page 39)

Learning remote control buttons and LCD
Program and operate other devices. See "Remote Control Operating Guide" which is provided with the projector.

RETURN Return to the previous menu. (page 30)

FREEZE Capture the projected image as a still image. (page 22)

INPUT Switch to cycle through the input method. (page 23)	LENS Display the LENS CONTROL menu and adjust the focus and size of the image. (page 25)	SLEEP Turn off the power automatically by setting the duration. (page 25)
ASPECT Switch to cycle through the aspect ratio. (page 23)	PIC.MODE Switch to cycle through the PICTURE MODE . (page 25)	MEM.LOAD Display the MEMORY LOAD menu. (page 23)
WAVEFORM Display the input waveform. (page 24)	PIC.ADJUST Display the PICTURE menu. (page 25)	COLOR M. Display the COLOR MANAGEMENT menu. (page 26)

NOTE:

- Do not drop the remote control.
- Avoid contact with liquids or moisture.
- Use manganese batteries or alkaline batteries with the remote control.
- Do not attempt to modify or disassemble the remote control. Contact an Authorized Service Center for repairs.
- Do not keep pressing the remote control buttons as this may shorten battery life.
- Do not point the laser in other people's eyes or stare into beam.
- See "Remote control operation" on page 22.

About Your Projector

Projector body

Top and front view

Preparation

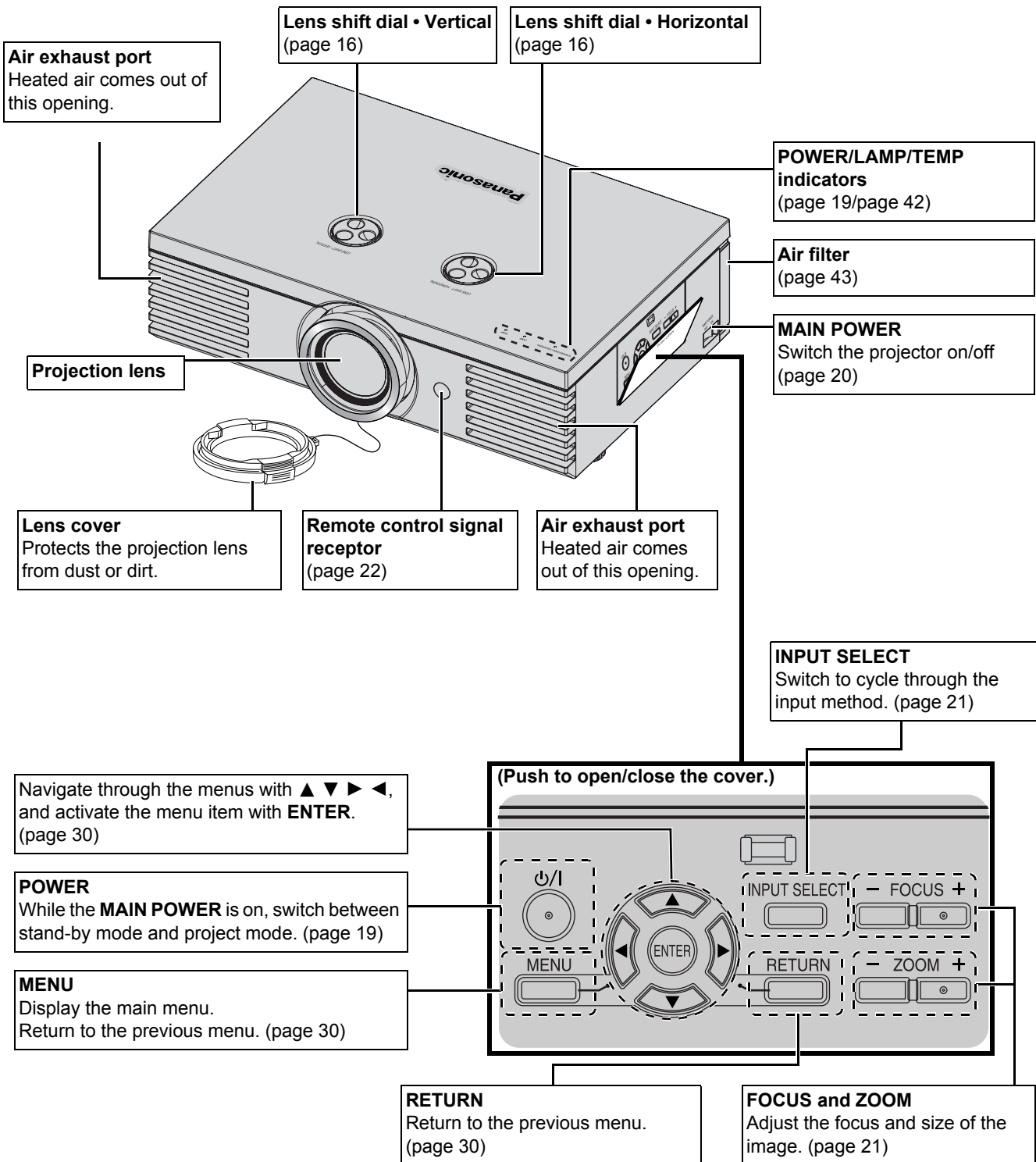

NOTE:

- Do not cover the ventilation openings or place anything within 50 cm (20") of them as this may cause damage or injury.
- While the projector is not in use, keep the lens cover to protect the lens.

Back and bottom view

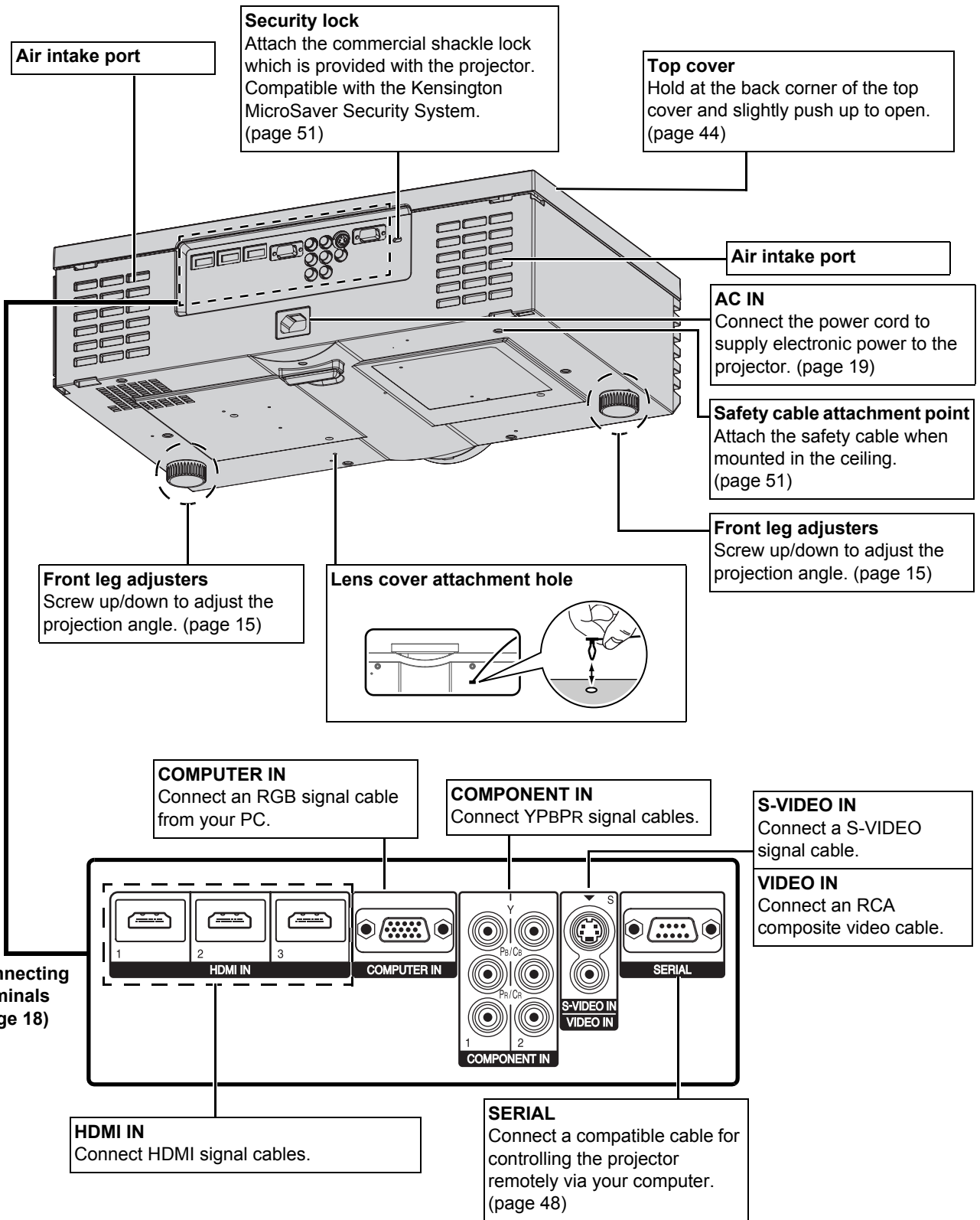

NOTE:

- Do not cover the ventilation openings or place anything within 50 cm (20") of them as this may cause damage or injury.
- The projector should only be used with the attached power cord to ensure optimum performance and avoid damage to the projector.
- Do not open the top cover other than replacing the lamp unit.

Setting up

Screen size and throw distance

You can adjust the projection size with 2.0x zoom lens. Calculate and define the throw distance as follows.

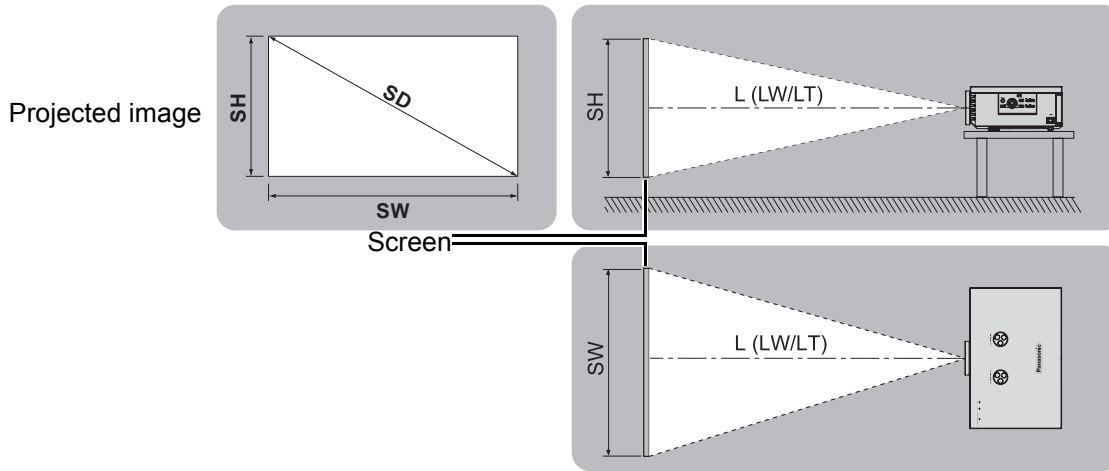

Getting Started

Projection size (16 : 9)			Throw distance (L)	
Screen Diagonal (SD)	Screen height (SH)	Screen width (SW)	Minimum distance (LW)	Maximum distance (LT)
1.01 m (40")	0.50 m (1'7")	0.89 m (2'11")	1.2 m (3'11")	2.3 m (7'6")
1.27 m (50")	0.62 m (2')	1.11 m (3'7")	1.5 m (4'11")	2.9 m (9'6")
1.52 m (60")	0.75 m (2'5")	1.33 m (4'4")	1.8 m (5'10")	3.5 m (11'5")
1.77 m (70")	0.87 m (2'10")	1.55 m (5'1")	2.1 m (6'10")	4.1 m (13'5")
2.03 m (80")	1.00 m (3'3")	1.77 m (5'9")	2.4 m (7'10")	4.7 m (15'8")
2.28 m (90")	1.12 m (3'8")	1.99 m (6'6")	2.7 m (8'10")	5.3 m (17'4")
2.54 m (100")	1.25 m (4'1")	2.21 m (7'3")	3.0 m (9'10")	5.9 m (19'4")
3.05 m (120")	1.49 m (4'10")	2.66 m (8'8")	3.6 m (11'9")	7.2 m (23'7")
3.81 m (150")	1.87 m (6'1")	3.32 m (10'10")	4.5 m (14'9")	9.0 m (29'6")
5.08 m (200")	2.49 m (8'2")	4.43 m (14'6")	6.0 m (19'8")	12.0 m (39'4")

* All measurements above are approximate and may differ slightly from the actual measurements.

Calculation methods for screen dimensions

You can calculate more detailed screen dimension from the screen diagonal.

$$SW (m) = SD (m) \times 0.872$$

$$SH (m) = SD (m) \times 0.490$$

$$LW (m) = 1.189 \times SD (m) - 0.04$$

$$LT (m) = 2.378 \times SD (m) - 0.05$$

* The results above are approximate and may differ slightly from the actual measurements.

NOTE:

- Do not use the projector at a raised or a horizontally tilted position as it may cause malfunction of the projector.
- Make sure the projector lens surface is parallel with the screen. You can tilt the projector body less than approximately $\pm 30^\circ$ vertically. Overtilting may result in shortening the component's life.
- For the best quality of the projection image, install a screen where sun light or room light does not shine directly onto the screen. Close window shades or curtains to block the lights.

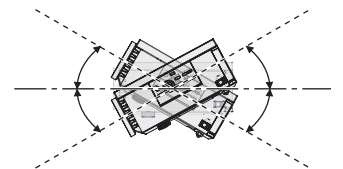

Projection method

You can use the projector with any of the following 4 projection methods. To set the desired method in the projector, See "INSTALLATION" on page 41.

■ Setting on a desk/floor and projecting from front

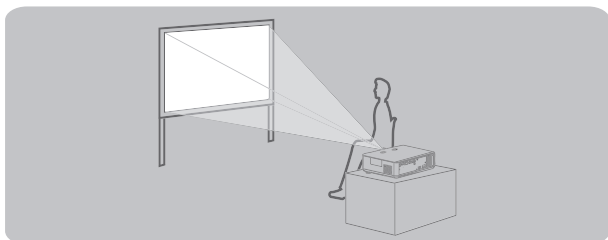

INSTALLATION: FRONT/DESK

■ Setting on a desk/floor and projecting from rear

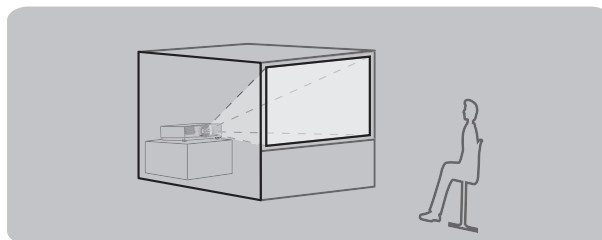

INSTALLATION: REAR/DESK

■ Mounting in the ceiling and projecting from front

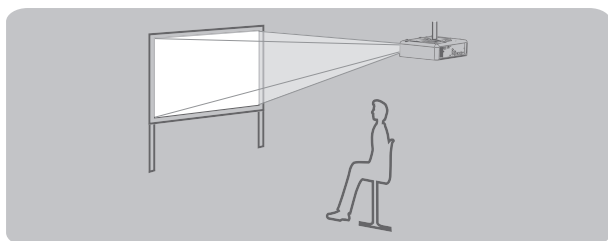

INSTALLATION: FRONT/CEILING

■ Mounting in the ceiling and projecting from rear

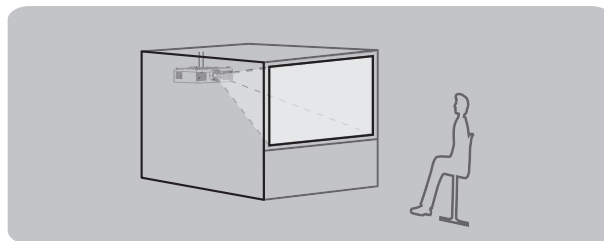

INSTALLATION: REAR/CEILING

NOTE:

- A translucent screen is required for rear projection.
- When mounting the projector in the ceiling, the optional ceiling mount bracket (ET-PKE2000, ET-PKE1000S) is required.
- See "Ceiling mount bracket safeguards" on page 51.

Front leg adjusters and throwing angle

You can screw up/down the front leg adjusters to control the angle of the projector for adjusting the throwing angle. See "Positioning the image" on page 21.

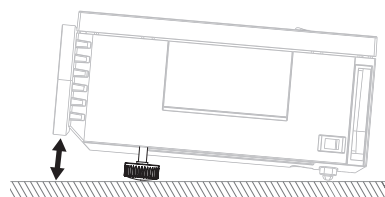
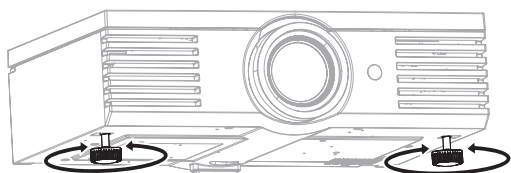

NOTE:

- Heated air comes out of the air exhaust port. Do not touch the air exhaust port directly.
- If keystone distortion occurs, see "KEYSTONE" on page 38.
- Screw up the adjuster legs, and an audible click will be heard as the limit.

Setting up

Lens shift and positioning

If the projector is not positioned right in front of the center of the screen, you can adjust the projected image position by moving the lens shift dials within the shift range of the lens.

Adjusting the lens shift dials

Horizontal shift

You can place the projector where the projector lens is up to 40% horizontally off-center from the screen and then adjust the image position with the **Lens shift dial • Horizontal**.

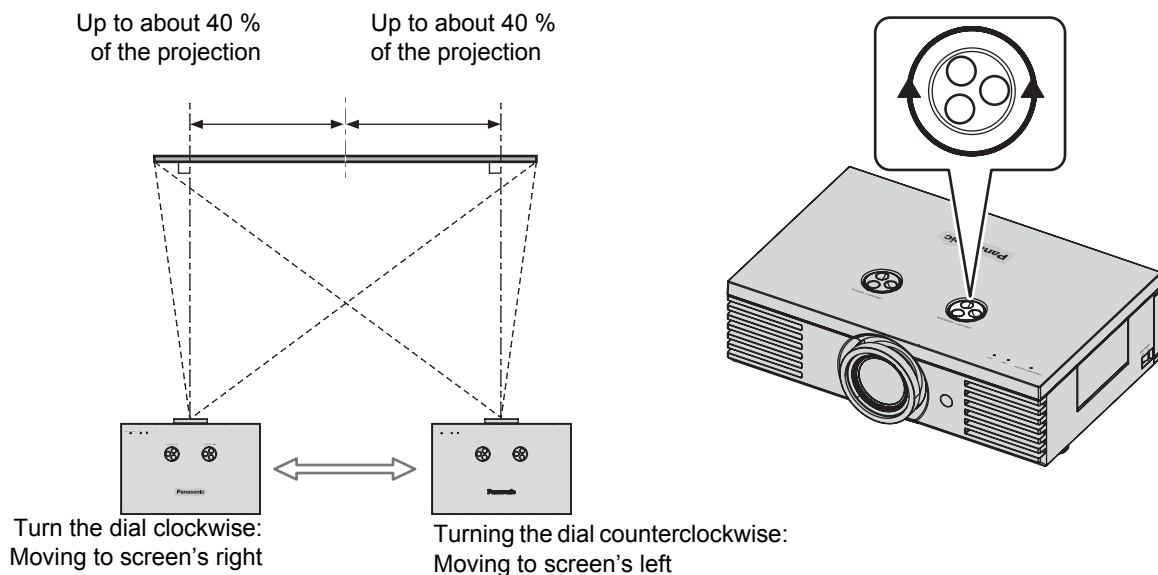

Vertical shift

You can place the projector where the projector lens is up to 100% vertically off-center from the screen and the adjust the image position with the **Lens shift dial • Vertical**.

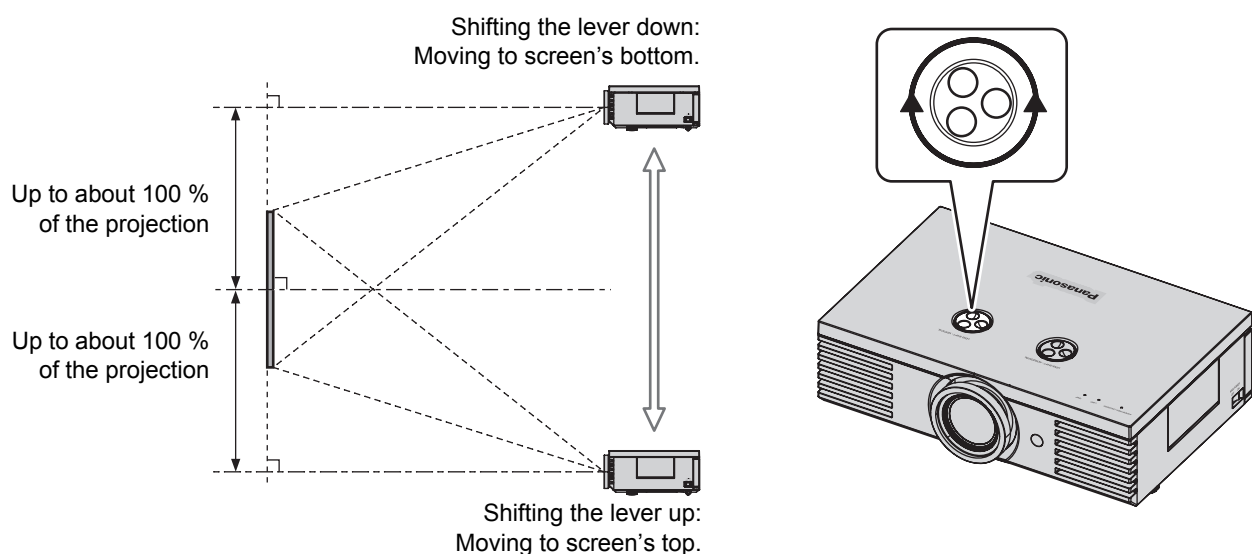

Projector location range

You can determine where to locate the screen and the projector by considering the lens shift possibilities. See "Positioning the image" on page 21.

When the screen position is fixed

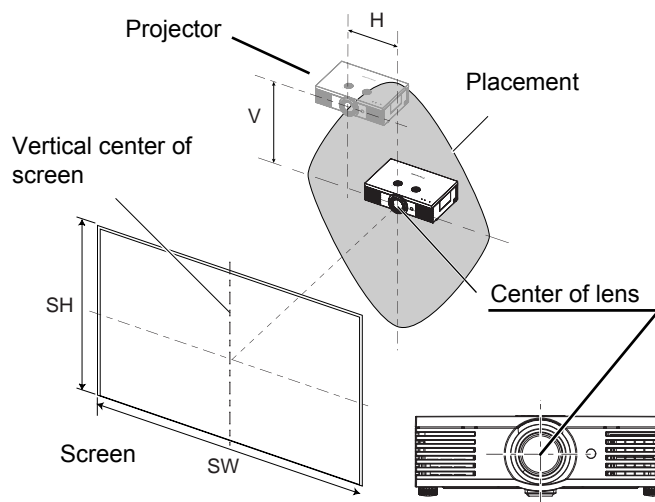

When the projector position is fixed

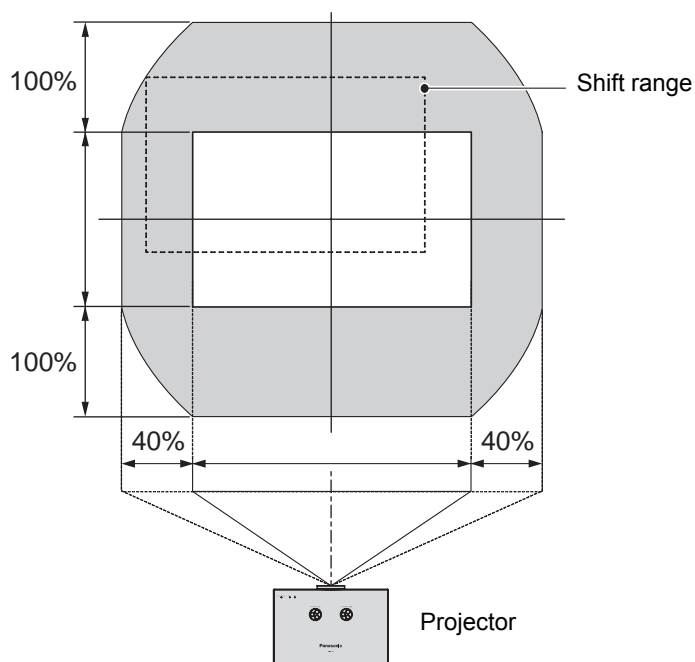

NOTE:

- When the projector is located right in front of the screen and the lens shift dials is centered, you will get the best quality of the projection image.
- When the **Lens shift dial • Vertical** is at the vertical limit of the shift range, you cannot turn the dial to the horizontal limit, likewise when the **Lens shift dial • Horizontal** is at the horizontal limit of the shift range, you cannot turn the dial to the horizontal limit.
- When the projector is tilted and you adjust **KEYSTONE**, the center of the screen and the lens need to be realigned.
- Do not force the lens shift dials to turn as this may damage the projector. Turning the dials maximum limit is 4 or 5 times from the default position.

Connections

Before connecting to the projector

- Read and follow the operating and connecting instructions of each peripheral device.
- The peripheral devices must be turned off.
- Use cables that match each peripheral device to be connected.
- Confirm the type of video signals. See “List of compatible signals” on page 47.
- Audio cables must be connected from each peripheral device directly to the audio reproduction system.

Connecting to COMPONENT IN/VIDEO IN/S-VIDEO IN

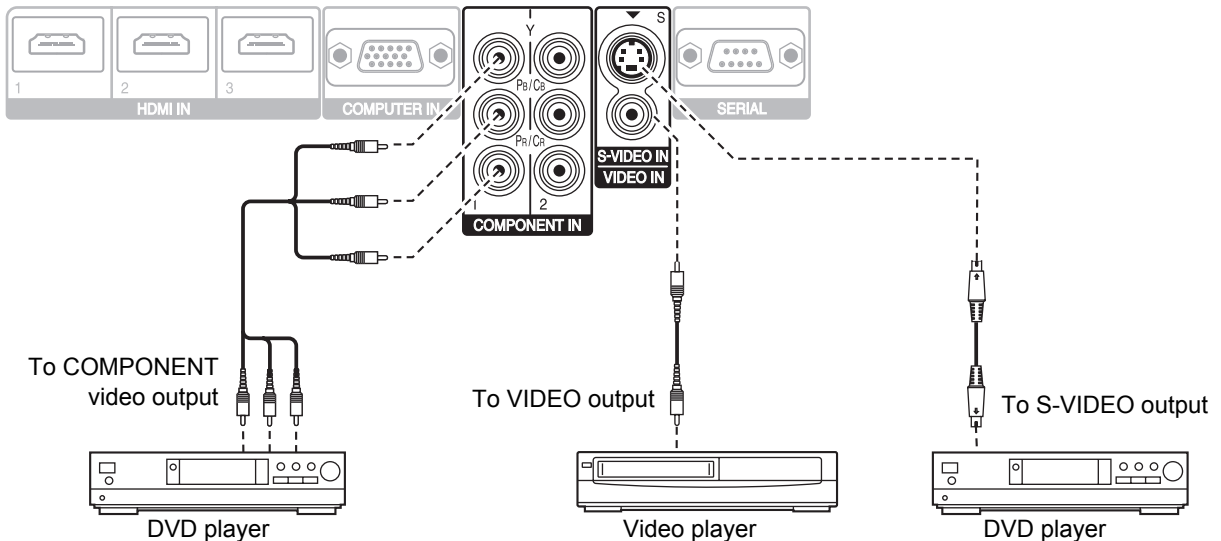

Getting Started

Connecting to COMPUTER IN/HDMI IN

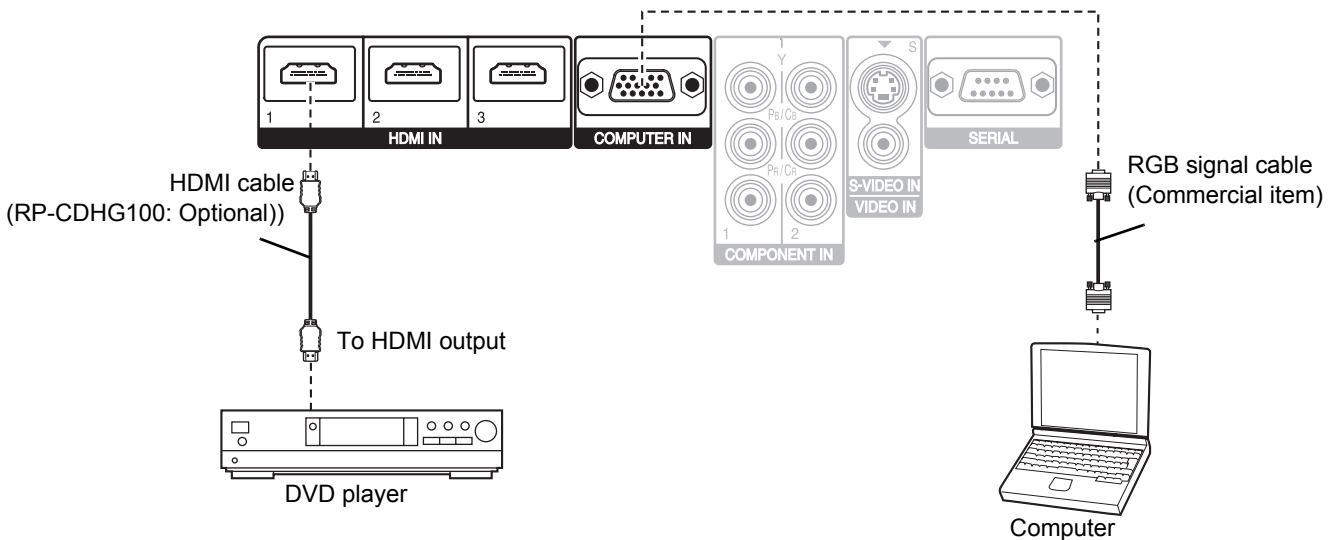

NOTE:

- Make sure the HDMI cable is adapted to your HDMI device for proper performance.
- A compatible cable is required for an HDMI 1 080p signal.
- It is possible to connect with DVI devices via a HDMI/DVI conversion adapter, but some equipment may not project the image properly or other problems could be encountered. “Serial terminal” on page 48

Switching the projector on/off

Power cord

Connecting

1. Make sure the shape of the power plug and the **AC IN** connector on the back of the projector match, then push the plug all the way in.
2. Connect the power cord to a wall outlet.

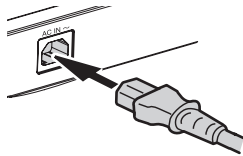

Disconnecting

1. Make sure the **MAIN POWER** is switched off and unplug the power cord from the wall outlet.
2. Hold the plug and unplug the power cord from the **AC IN** connector on the side of the projector.

NOTE:

- Do not use other than the provided power cord.
- Ensure all the input devices are connected and turned off before connecting the power cord.
- Do not force the connector as this may damage the projector and/or the power cord.
- Dirt or dust build-up around plugs may cause fire or electrical hazards.
- Switch off the power to the projector when not in use.

POWER indicator

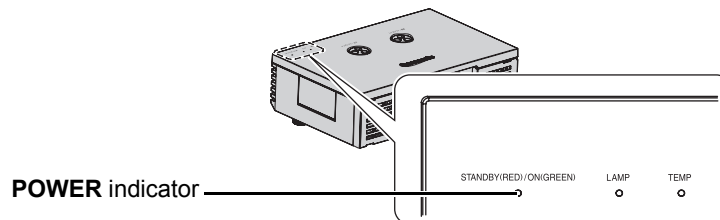

Indicator status		Status
No illumination or flashing		The MAIN POWER button is switched off.
Red	Lit	The MAIN POWER button is switched on and the projector is in standby.
Green	Flashing	The POWER button is switched on and the projector is getting ready to project.
	Lit	The projector is ready to project.
Orange	Lit	The POWER button is switched off and the projector is cooling the lamp.
	Flashing	The POWER button is switched on again when cooling the lamp and recovering to projection mode. Recovery may take a while.

NOTE:

- While the projector is cooling the lamp, do not switch the **MAIN POWER** button off or unplug the power cord.
- The electric consumption in standby mode is 0.08 W.

Switching the projector on/off

Switching on the projector

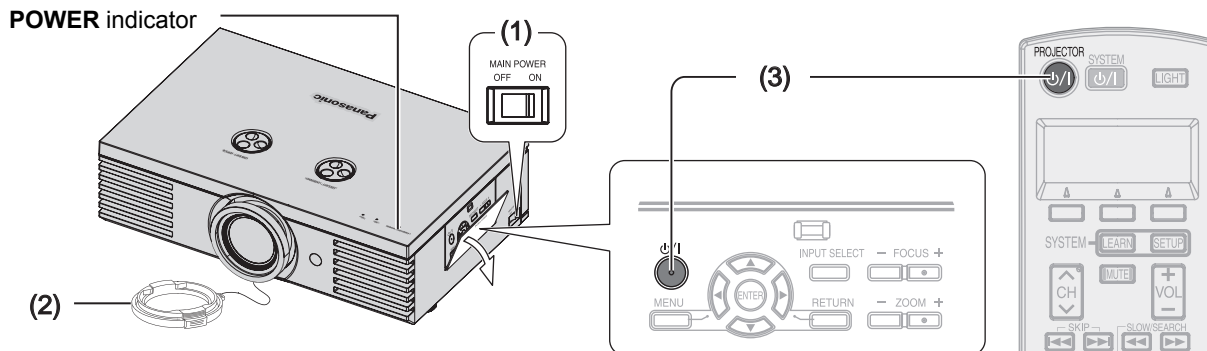

1. Switch the **MAIN POWER** button on.
 - The power indicator lights up in red.
2. Remove the lens cover from the lens.
3. Press the **POWER** button.
 - The power indicator lights up in green after flashing for a while.
 - The **STARTUP LOGO** is displayed on the screen. See "STARTUP LOGO" on page 40.

NOTE:

- When starting up the projector, some small rattling or tinkling sound may be heard, or the display may flicker for the characteristics of the lamp. Those are normal and do not affect the performance of the projector.
- Do not attempt to modify the lens cover which may cause burns, fire or damage to the projector.

Switching off the projector

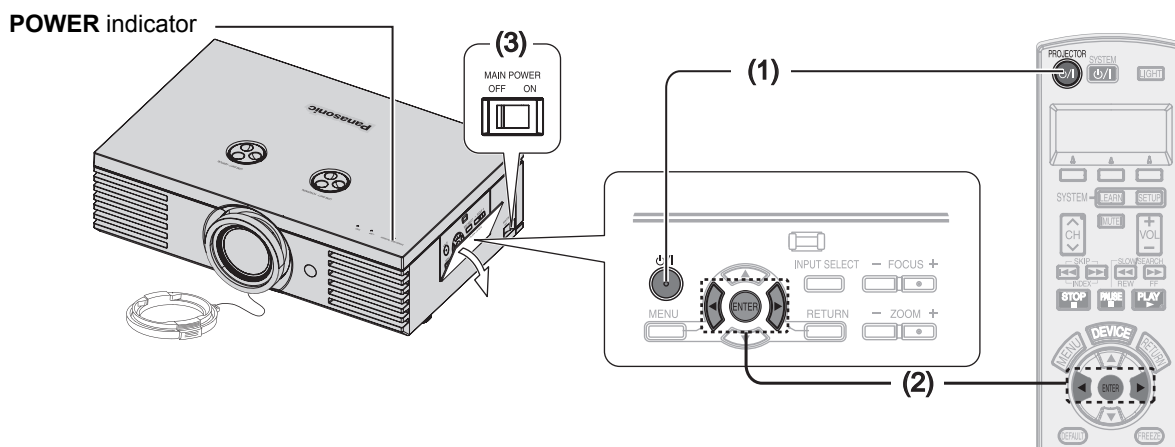

1. Press the **POWER** button.
 - The confirmation screen is displayed. It will disappear and return to the projection after 10 seconds without any operation.
 - To return to the projection, press any button except the **POWER** button.
2. Press **◀** to select **OK** and press the **POWER** or **ENTER** button.
 - The power indicator lights up in orange while cooling the lamp, then illuminates red when it is ready to switch off the **MAIN POWER** button.
3. Switch off the **MAIN POWER** button on the back of the projector.

NOTE:

- Press the **POWER** twice or for a long duration to switch the power off.

Projecting an image

Selecting the input signal

1. Switch on the connected devices.
 - Press the play button of the required device.
2. Press the **INPUT** button to select the required input method if needed. See "Switching the input signal" on page 23.
 - The image will be projected on the screen.

NOTE:

- **AUTO SEARCH** is **ON** as default and the signal from the connected devices is detected automatically. See "AUTO SEARCH" on page 40.

Positioning the image

1. Press the **ASPECT** button to select the required aspect mode. See "Switching the aspect ratio" on page 23.
2. Adjust the projected image with the lens shift dials. See "Lens shift and positioning" on page 16.
4. Adjust the focus and the projected image size.
 - Press +/- of the **FOCUS** and **ZOOM** buttons to adjust.
 - Press the **LENS** button to adjust the focus and zoom by the remote control. See.....

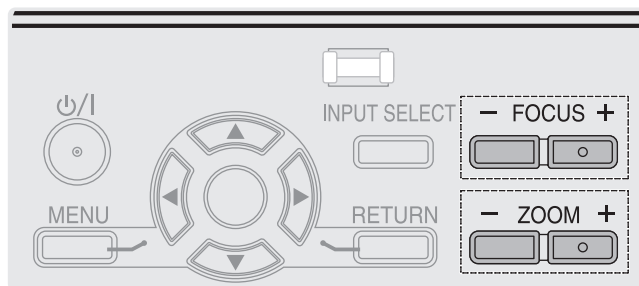
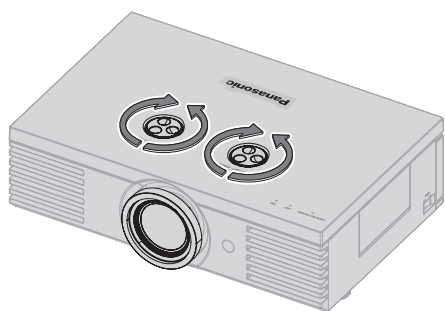

3. Adjust the angle of the projector.
 - Screw down the front leg adjusters and adjust the angle vertically.
 - See "Front leg adjusters and throwing angle" on page 15.

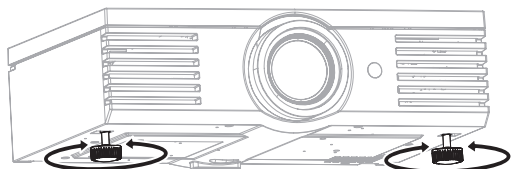

NOTE:

- Do not touch the air exhaust port as this may cause burns or injury.
- If keystone distortion occurs, see "KEYSTONE" on page 38.
- If you adjust the focus, you may need to adjust the size of the image by pressing the **ZOOM** button again.

Remote control operation

Operating range



You can operate the projector with the remote control within the remote range 7 m (22'11").

● Facing to the projector

Ensure the remote control emitter is facing to the remote control signal receptor on front/back of the projector and press the required buttons to operate.

● Facing to the screen

Ensure the remote control emitter is facing to the screen and press the required buttons to operate the projector. The signal will be reflected off the screen. The operating range may differ due to the screen material. This function may not be effective with a translucent screen.

NOTE:

- Do not let strong light shine onto the signal receptor. The remote control may malfunction under strong light such as fluorescent.
- If there are any obstacles between the remote control and the remote control signal receptor, the remote control may not operate correctly.

Turning on the button backlight

LIGHT

In a dark room, you can turn on the button backlight to operate the remote control. Press the **LIGHT** button on the upper right corner of the unit to turn on the backlight and enter the light-on mode.

After 30 seconds without any operation, the backlight will go out and press any but the **LIGHT** button to turn on again. To escape from the light-on mode, press the **LIGHT** button.

Resetting to the factory default settings

DEFAULT

You can reset most of the customized settings to the factory defaults by pressing **DEFAULT** button of the remote control. Display the required sub-menu or the menu items and press the button again.

NOTE:

- Some menu items are not available to reset by pressing the **DEFAULT** button. Adjust each menu items manually.

Capturing an image

FREEZE

When projecting an image, press **FREEZE** button to capture the projected image and display it on the screen as a still picture. Press again to escape.

You can adjust **AREA SELECT** of the **SPLIT ADJUST** menu by pressing the **ENTER** button while the frozen image is displayed. See "SPLIT ADJUST" on page 32.

Switching the input signal

INPUT

You can switch the input method manually by pressing the **INPUT** button. Press the button several times or press ◀ ▶ to cycle through the input methods as follows. The actual projected image will be changed in a while.

- The graphical guidance will be displayed on the upper right of the projected image and you can confirm the selected input method which is highlighted in yellow. See "INPUT GUIDE" on page 40.

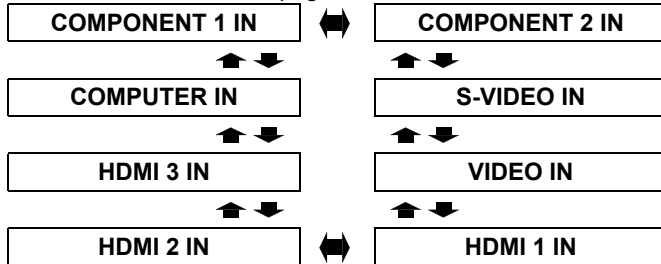

COMPONENT 1 IN	COMPONENT (YPBPR) signals from the equipment connected to COMPONENT IN 1/ COMPONENT IN 2.
COMPONENT 2 IN	
S-VIDEO IN	S-VIDEO signal from the equipment connected to S-VIDEO IN.
VIDEO IN	VIDEO signal from the equipment connected to VIDEO IN.
HDMI 1 IN	HDMI signal from the equipment connected to HDMI IN 1/HDMI IN 2/ HDMI IN 3.
HDMI 2 IN	
HDMI 3 IN	
COMPUTER IN	COMPUTER (RGB) signal from the equipment connected to COMPUTER IN.

NOTE:

- If you select an unplugged input method, the guidance will blink on and off several times.
- See "List of compatible signals" on page 47.
- See "Connections" on page 18.

Switching the aspect ratio

ASPECT

The aspect ratio will be selected automatically, or you can switch it manually by pressing the **ASPECT** button. Press the button several times to cycle through the different aspect type as follows. See "ASPECT" on page 36.

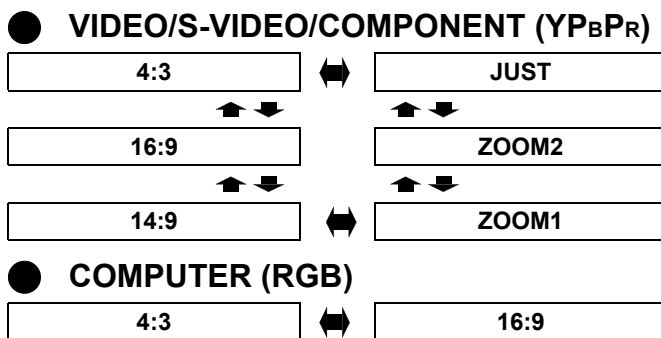

● HDMI



NOTE:

- If you project an image with an unmatched aspect ratio, the image may distort or some portions may be cropped. Select an aspect ratio which preserves the intention of the image creator.
- The order of aspect type is defined not only by the input method but also by the input signals. See "List of compatible signals" on page 47.
- If you project a copyrighted image enlarged or distorted by using **ASPECT** function in commercial use in a public place, such as a restaurant or hotel, you might infringe on the copyright of the creator which is protected by copyright law.

Loading a saved setting

MEM.LOAD

You can access saved settings instantly. See "MEMORY LOAD" on page 34.

- Select the required setting from **MEMORY1 - 16**.
 - Undefined setting will not be displayed.
- Press **ENTER** to activate the selected setting.

NOTE:

- If you have not saved any settings, **MEMORY1 - 16** will not be displayed.

Remote control operation

Adjusting the signal condition with a waveform

WAVEFORM

You can display the image brightness and contrast level of the input signal with a waveform. See "WAVEFORM MONITOR" on page 32.

FULL SCAN	Monitoring the waveform of brightness and contrast of the whole image.
SINGLE LINE SCAN	Monitoring the waveform of brightness and contrast in each horizontal line of the image.

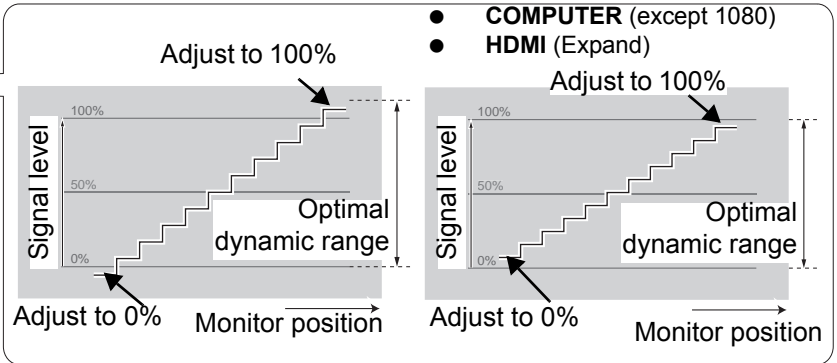
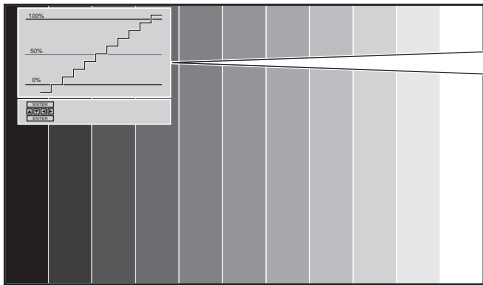

- **COMPUTER** (except 1080)
- **HDMI** (Expand)

■ Displaying the waveform

1. Press the **WAVEFORM** button and display the waveform monitor.
 - Press the **WAVEFORM** button again to escape from the waveform mode.
2. Press **ENTER** button until the required waveform option is displayed.
 - In **FULL SCAN** mode, press ▲ ▼ ◀ ▶ to change the waveform position.
 - In **SINGLE LINE SCAN** mode, press ▲ ▼ to select the required line position.

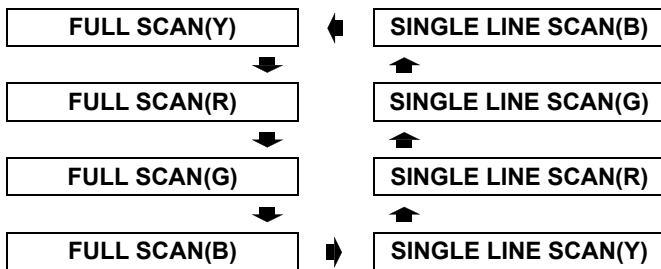

NOTE:

- In **SINGLE LINE SCAN** mode, the position of the waveform monitor depends on the position of the selected line.
- You can display the main menu by pressing the **MENU** button and adjust the menu items.
- The called up menu items displayed position depends on the position of the waveform monitor.
- You can activate **AUTO ADJUST** of the **WAVEFORM** menu by pressing the **DEFAULT** button.
- The signal which is lower than 0% in the waveform will be displayed as same as 0% on the projected image.
- While the waveform is displayed, the image is displayed without the **COLOR MANAGEMENT** adjustment.
- When adjusting the **KEystone** of the **POSITION** menu while the waveform is displayed, **xvYCC** will be deactivated.

■ Adjustment example

Project a commercial test signal for picture adjustment on the screen and press the **WAVEFORM** button.

- **Adjusting with luminance options**
 1. Press the **ENTER** button until **FULL SCAN(Y)/SINGLE LINE SCAN(Y)** is displayed.
 2. Press the **PIC. ADJUST** to display the **PICTURE MODE** of the **PICTURE** menu.
 3. Press ▼ several times to display the **BRIGHTNESS**.
 4. Adjust the **BRIGHTNESS** by pressing ◀ ▶.
 - Adjust the bottom line of the waveform to 0% (0 or 7.5 IRE).
 - Setting range: -32 to +32
 5. Press ▼ once to display the **CONTRAST**.
 6. Adjust the **CONTRAST** by pressing ◀ ▶.
 - Adjust the top line of the waveform to 100% (100 IRE).
 - Setting range: -64 to +64

FULL SCAN(Y)/SINGLE LINE SCAN(Y)	
BRIGHTNESS	Adjust the bottom line of the waveform to 0% (0 IRE or 7.5 IRE)
CONTRAST	Adjust the top line of the waveform to 100% (100 IRE)

Adjusting with RGB options

1. Press the **ENTER** button until the required option is displayed.
2. Press the **PIC. ADJUST** twice to display the **GAMMA** of the **ADVANCED MENU** menu.
3. Press **▼** several times to display the required brightness option.
4. Adjust the brightness option by pressing **◀ ▶**.
 - Adjust the bottom line of the waveform to 0% (0 IRE or 7.5 IRE).
 - Setting range: -16 to +16
5. Press **▼** once to display the required contrast option.
6. Adjust the contrast option by pressing **◀ ▶**.
 - Adjust the top line of the waveform to 100% (100 IRE).
 - Setting range: -32 to +32

FULL SCAN(R)/SINGLE LINE SCAN(R)	
BRIGHTNESS R	Adjust the bottom line of the waveform to 0% (0 IRE or 7.5 IRE)
CONTRAST R	Adjust the top line of the waveform to 100% (100 IRE)
FULL SCAN(G)/SINGLE LINE SCAN(G)	
BRIGHTNESS G	Adjust the bottom line of the waveform to 0% (0 IRE or 7.5 IRE)
CONTRAST G	Adjust the top line of the waveform to 100% (100 IRE)
FULL SCAN(B)/	
BRIGHTNESS B	Adjust the bottom line of the waveform to 0% (0 IRE or 7.5 IRE)
CONTRAST B	Adjust the top line of the waveform to 100% (100 IRE)

Adjusting the focus and zoom

LENS

You can adjust the focus and zoom of the projected image. Press the **LENS** button to

display the **LENS CONTROL** menu. See "LENS CONTROL" on page 39.

Switching the picture mode

PIC.MODE

You can switch the preset picture mode settings by pressing the **PIC. MODE** button. Press the button until the required setting is selected. See "PICTURE MODE" on page 31.

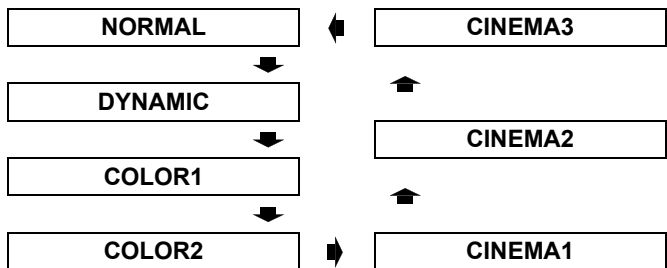

Adjusting the image

PIC.ADJUST

You can display the **PICTURE** and **ADVANCED MENU** menu items with called up style by pressing the **PIC. ADJUST** button. Press the button to switch between **PICTURE** and **ADVANCED MENU** menu. Press **▲ ▼** to select the required menu item and **◀ ▶** to adjust.

- **PICTURE menu items**
PICTURE MODE, CONTRAST, BRIGHTNESS, COLOR, TINT, SHARPNESS, COLOR TEMPERATURE and DYNAMIC IRIS

- **ADVANCED MENU items**
GAMMA, CONTRAST, BRIGHTNESS, xvYCC, DETAIL CLARITY, NR, MPEG NR, CINEMA REALITY and TV-SYSTEM

NOTE:

- For each menu items description, see "PICTURE menu" on page 31.
- The screen will be cleared after 7 seconds without any operation.

Switching off the projector automatically

SLEEP

You can switch off the **POWER** automatically by setting the **SLEEP** feature. Press the **SLEEP** button several times to cycle through the duration of time. See "SLEEP" on page 41.

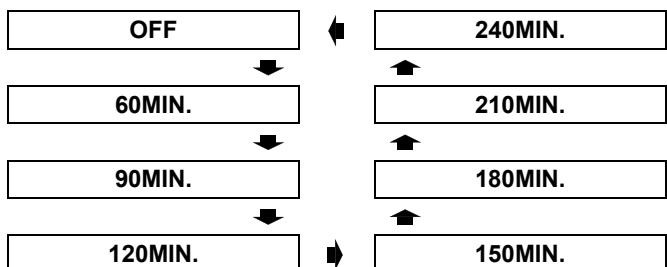

Remote control operation

Setting your own color profile

COLOR M.

You can adjust a selected color individually and save and retrieve under the **PICTURE MODE** setting. Press the **COLOR M.** button to open the menu.

PROFILE	◀ NORMAL ▶
CURSOR	
LOG	
PROFILE SAVE	
PROFILE DELETE	
PROFILE NAME CHANGE	

- Select a menu item and the ◀ ▶ to adjust each item level.
 - The result box is displayed on the right of the cursor and shows the adjusted color.

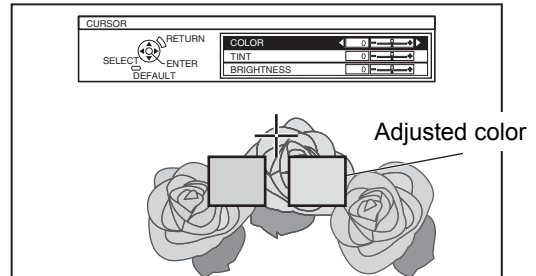

Create a new profile

Adjusting the selected color

Select a color and adjust **COLOR**, **TINT** and **BRIGHTNESS**.

- Select the **CURSOR** menu and press **ENTER**.
 - The projected image is captured, and the target cursor is displayed.
 - When the **LOG** is fully stored, the target cursor will not be displayed. See "Managing stored logs" on page 26.

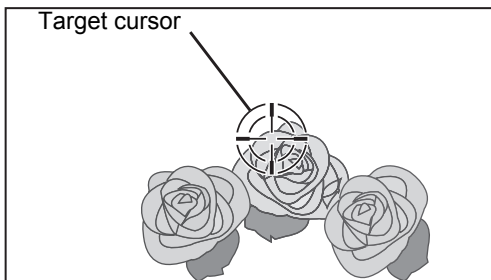

COLOR	Adjust the vividness of the color. Setting range: -30 to +30
TINT	Adjust the color tone. Setting range: -30 to +30
BRIGHTNESS	Adjust the brightness of the color. Setting range: -20 to +20

- Press **ENTER** to store the adjusted result.
 - "**PROCESSING**" is displayed for a few seconds and the result is stored in **LOG**.
 - You can store up to 8 logs under **LOG** for each **PICTURE MODE** setting.
- Press **MENU** or **RETURN** to return to the previous menu.
 - Repeat the steps above to store more adjustment.

Managing stored logs

You can edit or delete the stored logs of the selected **PICTURE MODE**.

- Select **LOG** and press **ENTER**.
 - The **LOG** menu is displayed.

PICTURE MODE : CINEMA1			
POINT1	0	0	+2
POINT2	-1	0	-2
POINT3	0	+10	0
POINT4	-10	+10	-10
POINT5	-6	+5	+7
POINT6	+3	-3	+1
POINT7	0	+7	+9
POINT8	-1	+14	-4
ALL DELETE			

- Move the cursor with ▲ ▼ ◀ ▶ to the required place to select a color and press **ENTER**.
 - The color at the center of the target cursor is sampled and the sample box is displayed on the left of the cursor. The menu items are displayed on the upper part of the screen.

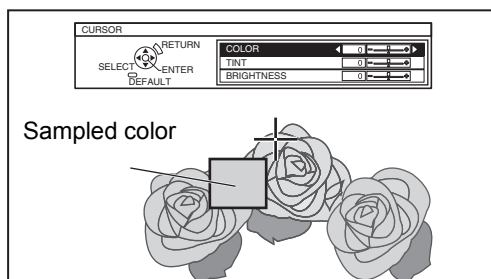

Sampled color  Adjusted color 

- Select the required log from 1 - 8 or **ALL DELETE**, and press **ENTER**.
 - Select **CHANGE** to edit the log.
The cursor menu is displayed and you can readjust the color.
 - Select **DELETE** to delete the log.
The confirmation screen will be displayed. Select **OK** to delete.
 - When you select **ALL DELETE**, the "**DELETE ALL LOG.**" screen is displayed. Select **OK** to delete all logs. The **PROFILE** setting will be set to **NORMAL**.

● **Saving a log setting as a profile**

Return to the **COLOR MANAGEMENT** menu and save the stored log as a profile. Make sure that the **PICTURE MODE** is not switched.

1. Select the **PROFILE SAVE** menu and press **ENTER**
 - The **PROFILE SAVE** menu is displayed. You can save the profile as **USER1**, **USER2** and **USER3**.

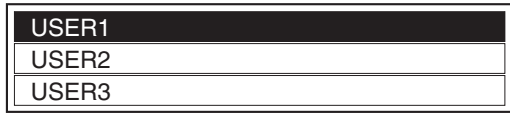

2. Press **ENTER** to save the profile
 - The confirmation screen is displayed. Press **ENTER** again to save.
3. Use **▲ ▼ ◀ ▶** to specify the location of the required character to enter and press the **ENTER** button.
 - You can enter up to 14 characters.

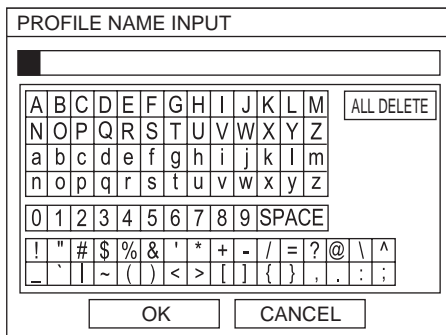

4. Repeat step 3 until you finish the text line.
 - Move cursor to **ALL DELETE** and press the **ENTER** button to delete all the entered text line.
 - Press the **DEFAULT** button to delete the last entered character or indicated with cursor in the text box.
 - To insert a character in the entered text line, move the cursor to the text box to select the required place and press **▼** then perform step 4.
5. Select **OK** and press the **ENTER** button to set the entered text as a name.
 - Press the **ENTER** button without entering any text to keep the default name.

● **Deleting the saved profiles**

You can delete the profiles from **PROFILE DELETE** menu.

1. Select **PROFILE DELETE** and press the **ENTER** button.
2. Select the required profile or **ALL DELETE** and press the **ENTER** button.
 - The confirmation screen will be displayed and select **OK**.
3. Press the **ENTER** button.

● **Changing the profile names**

You can change the name of the profiles from the **PROFILE NAME CHANGE** menu.

1. Select **PROFILE NAME CHANGE** and press the **ENTER** button.
2. Select the required profile and press the **ENTER** button.
3. Use **▲ ▼ ◀ ▶** to specify the location of the required character to enter and press the **ENTER** button.
4. Select **OK** and press the **ENTER** button to set the entered text as a name.

● **Loading saved profiles**

When profiles are loaded under the **PICTURE MODE** setting, you can keep them as you defined until the **PROFILE** is set to **NORMAL**.

1. Select the required **PICTURE MODE** and press **ENTER**.
2. Press the **COLOR M.** button and select the **PROFILE** menu.
 - The profile settings of the selected **PICTURE MODE** will be displayed.
3. Select the required profile and press **ENTER**.

NORMAL	Return to the default setting of the PICTURE MODE menu.
USER1	
USER2	Defined profile settings.
USER3	

NOTE:

- **LOG** and **PROFILE SAVE** are not displayed before you apply **COLOR MANAGEMENT**.
- If you load a profile with a different attribute mode of the profile, the **CURSOR** and **PROFILE SAVE** menus will not be displayed.
- The approximate colors will be adjusted at the same time. If you adjust the exact same color differently, both colors will affect each other and you might get unexpected results.
- White, Black and Gray are not adjustable.
- If you escape the **COLOR MANAGEMENT** menu or attempt to perform another menu action before you save the adjusted profile, the confirmation screen will be displayed.
- If you switch the input signal before you save the profile, the setting will be cancelled without notice.

Menu Navigation

The menu system allows you to access functions which do not have their own dedicated buttons on the remote control. The menu options are structured and categorized. You can navigate through the menu with ▲ ▼ ► ◀ buttons.





Main menu and sub-menu

NOTE:

- Some default settings vary by the selected input signal.
- Sub-menu items vary according to the selected input signal.
- Some settings are adjustable without any signals.

Main menu	Sub-menu	Options (Underlined is default setting)			Page	
PICTURE 	PICTURE MODE	<u>NORMAL</u>	DYNAMIC	COLOR1	page 31	
		COLOR2	CINEMA1	CINEMA2		
		CONTRAST	• Default: 0			page 31
		BRIGHTNESS	• Default: 0			page 31
		COLOR	• Default: 0			page 31
		TINT	• Default: 0			page 31
		SHARPNESS	• Default: 0			page 31
		COLOR TEMPERATURE	• Default: 0			page 32
		DYNAMIC IRIS	<u>ON</u>	OFF		page 32
		WAVEFORM MONITOR	<u>OFF</u>	SINGLE LINE SCAN(Y)	SINGLE LINE SCAN(R)	page 32
			FULL SCAN(Y)	SINGLE LINE SCAN(G)	SINGLE LINE SCAN(B)	
			FULL SCAN(R)	MONITOR POSITION	AUTO ADJUST	
			FULL SCAN(G)			
			FULL SCAN(B)			
		SPLIT ADJUST	AREA SELECT			page 32
			SPLIT ADJUST MODE		<u>NORMAL</u> REVERSE	
		ADVANCED MENU	GAMMA	GAMMA HIGH	• Default: 0	page 33
				GAMMA MID	• Default: 0	
				GAMMA LOW	• Default: 0	
			CONTRAST	CONTRAST R	• Default: 0	
			CONTRAST G	• Default: 0		
			CONTRAST B	• Default: 0		
		BRIGHTNESS	BRIGHTNESS R	• Default: 0		
			BRIGHTNESS G	• Default: 0		
			BRIGHTNESS B	• Default: 0		
		COLOR MANAGEMENT	PROFILE CURSOR LOG PROFILE SAVE PROFILE DELETE PROFILE NAME CHANGE			
		xvYCC	<u>ON</u>	OFF		
		DETAIL CLARITY	<u>ON</u>	OFF		
		NR	<u>ON</u>	OFF		
		MPEG NR	<u>ON</u>	OFF		
		CINEMA REALITY	<u>ON</u>	OFF		
		TV-SYSTEM	AUTO SECAM PAL	PAL-N NTSC 4.43 PAL-M NTSC		
	MEMORY SAVE	MEMORY1 - 16			page 34	
	MEMORY LOAD	MEMORY1 - 16			page 34	
	MEMORY EDIT	MEMORY DEL	MEMORY NAME CHANGE		page 35	
	SIGNAL MODE*1				page 35	

*1. COMPUTER/COMPONENT/HDMI signals only

Main menu	Sub-menu	Options (Underlined is default setting)	Page
POSITION 	H-POSITION	• Default: 0	page 36
	V-POSITION	• Default: 0	page 36
	DOT CLOCK* ¹	• Default: 0	page 36
	CLOCK PHASE* ²	• Default: 0	page 36
	ASPECT	<u>4:3</u> <u>16:9</u> <u>14:9</u> ZOOM1 ZOOM2 JUST	page 36
	WSS* ³		page 38
	OVER SCAN* ⁴	• Default: 0	page 38
	KEystone	• Default: 0	page 38
	AUTO SETUP* ⁵		page 38
LENS CONTROL	ZOOM/FOCUS		page 39
FUNCTION BUTTON 	BUTTON1 BUTTON2 BUTTON3		page 39
	LANGUAGE  <div style="display: flex; justify-content: space-around; margin-top: 10px;"> <div style="border: 1px solid black; padding: 5px; width: 45%;"> <p style="text-align: right;">1/2</p> <p>DEUTSCH</p> <p>FRANÇAIS</p> <p>ESPAÑOL</p> <p>ITALIANO</p> <p>PORTUGUÊS</p> <p>SVENSKA</p> <p>NORSK</p> <p>DANSK</p> </div> <div style="border: 1px solid black; padding: 5px; width: 45%;"> <p style="text-align: right;">2/2</p> <p>POLSKI</p> <p>ČEŠTINA</p> <p>MAGYAR</p> <p>РУССКИЙ</p> <p>ไทย</p> <p>한국어</p> <p>● ENGLISH</p> <p>中文</p> </div> </div>		
OPTION 	INPUT GUIDE	<u>DETAILED</u> SIMPLE OFF	page 40
	OSD DESIGN	<u>TYPE1</u> TYPE2 TYPE3	page 40
	OSD POSITION	UPPER LEFT UPPER CENTER UPPER RIGHT LOWER LEFT LOWER CENTER LOWER RIGHT	page 40
	BACK COLOR	<u>BLUE</u> BLACK	page 40
	STARTUP LOGO	<u>ON</u> OFF	page 40
	AUTO SEARCH	<u>ON</u> OFF	page 40
	HDMI SIGNAL LEVEL	<u>NORMAL</u> EXPAND	page 40
	FRAME RESPONSE	<u>NORMAL</u> FAST	page 40
	INSTALLATION	<u>FRONT/DESK</u> FRONT/CEILING REAR/DESK REAR/CEILING	page 41
	SLEEP	<u>OFF</u> 60MIN. 90MIN. 120MIN. 150MIN. 180MIN. 210MIN. 240MIN.	page 41
	ALTITUDE	<u>LOW</u> HIGH	page 41
	LAMP POWER	<u>NORMAL</u> ECO-MODE	page 41
	LAMP RUNTIME		page 41

*1. COMPUTER signals only
 *2. COMPUTER/COMPONENT signals only
 *3. VIDEO/S-VIDEO/COMPONENT signals only
 *4. Not available with COMPUTER signals
 *5. COMPUTER signals only

Menu Navigation

Navigating through the MENU

Displaying the main menu



Press the **MENU** button to display the main menu and the operating guidance.

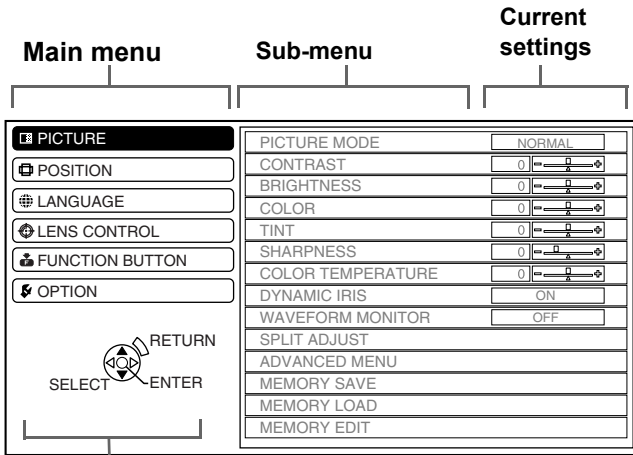

Operating guidance

Contains the required buttons to adjust the settings.

Adjusting with the bar scale items

The triangle mark under the bar indicates factory default setting and the square indicates the current setting.

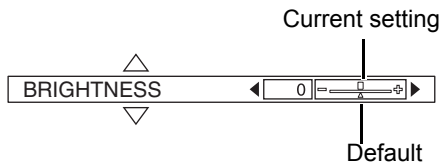

Returning to the previous menu



Press the **MENU** or **RETURN** button to return to the previous menu. Press repeatedly to escape from the menu mode and return to the projection.

Operating procedure

- Press **▲ ▼** to scroll to the required main menu item and press **ENTER** to select.
 - The selected item is highlighted in orange and the sub-menu is displayed on the right.
 - See "Main menu and sub-menu" on page 28.

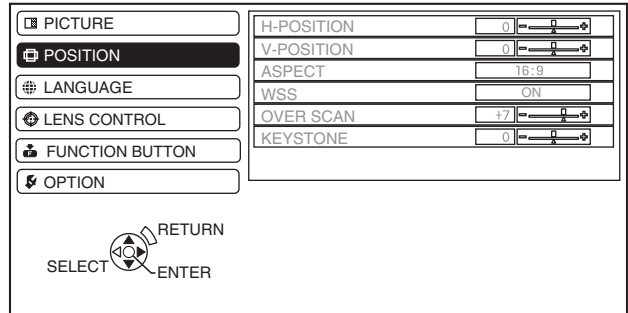

- Press **▲ ▼** to scroll to the required sub-menu item and press **◀ ▶** or **ENTER** to adjust.
 - The selected item is called up and the other menu items disappear from the screen. Called up item will be disappear after 5 seconds and return to the menu mode.
 - If there is a lower level, the next level will be displayed.

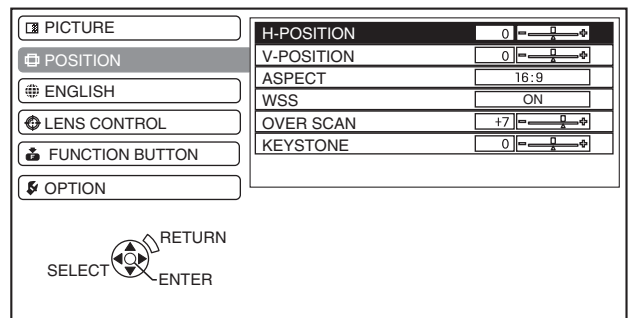

- Press **◀ ▶** to adjust or set the selected item.
 - For items using a bar scale, the current settings are displayed on the left of the bar scale.
 - You can cycle through the options of an item by pressing **◀ ▶**.

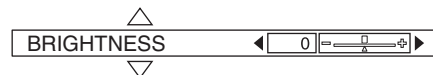

- Press **MENU** or **RETURN** to return to the previous menu.

NOTE:

- See "Resetting to the factory default settings" on page 22 to reset each menu items.

PICTURE menu

Remote control



Control panel

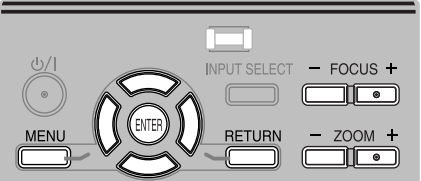

- See "Navigating through the MENU" on page 30.
- See "Main menu and sub-menu" on page 28.

PICTURE MODE

Depending on the projection environment, you can use these preset parameter settings to optimize image projection. Press ◀ ▶ to cycle through the options.

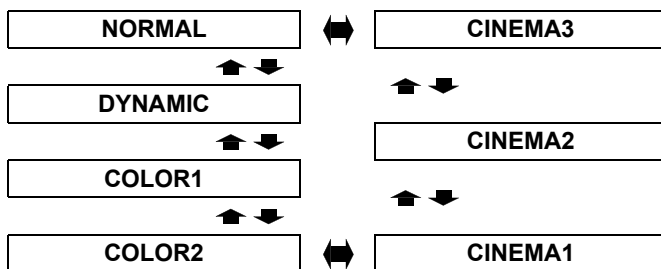

NORMAL	Setting for a general image, such as sports or games
DYNAMIC	Bright and sharp setting
COLOR1	Setting for HDTV standard in ITU-R BT. 709 and color temperature 6 500 K at the default setting of the PICTURE menu items.
COLOR2	Setting for DCDM standard (SMPTE431-2) and color temperature 6 300 K at the default setting of the PICTURE menu items.
CINEMA1	Hollywood style colors
CINEMA2	Deeper and more rich color setting
CINEMA3	Vivid and crisp color setting

NOTE:

- It may take for a while until the selected mode is stabilized.

CONTRAST

You can adjust the contrast of the projected image. Adjust the **BRIGHTNESS** in advance if necessary.



- Setting range: -64 to +64

BRIGHTNESS

You can adjust the brightness of the projected image.



- Setting range: -32 to +32

COLOR

You can adjust the color saturation of the projected image.



- Setting range: -32 to +32
- When **COMPUTER** signal is connected, only available with the following signals.

1 125 (1 080)/60i	1 125 (1 080)/50i
1 125 (1 080)/60p	1 125 (1 080)/50p

TINT

You can adjust the skin tone in the projected image.



- Setting range: -32 to +32
- When **COMPUTER** signal is connected, only available with the following signals.

1 125 (1 080)/60i	1 125 (1 080)/50i
1 125 (1 080)/60p	1 125 (1 080)/50p

SHARPNESS

You can adjust the sharpness of the projected image.



- Setting range will vary according to the selected input signal.

PICTURE menu

COLOR TEMPERATURE

You can adjust the white balance of the projected image.



- Setting range: -6 to +6

DYNAMIC IRIS

You can switch automatic adjustment of the lamp and the lens iris on/off.

- **ON:** Automatic adjustment
- **OFF:** No adjustment

WAVEFORM MONITOR

You can monitor whether or not the luminance level of the input signal is in the recommended range by displaying it in the waveform monitor. If the waveform is not in the range, adjust it for the best quality. See "Adjusting the signal condition with a waveform" on page 24.

<input checked="" type="radio"/> OFF	
FULL SCAN(Y)	
FULL SCAN(R)	
FULL SCAN(G)	
FULL SCAN(B)	
SINGLE LINE SCAN(Y)	
SINGLE LINE SCAN(R)	
SINGLE LINE SCAN(G)	
SINGLE LINE SCAN(B)	
MONITOR POSITION	◀ UPPER LEFT ▶
AUTO ADJUST	

1. Press ▲ ▼ to move to the required waveform style.
2. Press **ENTER** to select.
 - The **WAVEFORM MONITOR** will be displayed.
 - See "Adjusting the signal condition with a waveform" on page 24.

MONITOR POSITION

When the **FULL SCAN** is selected, press ▲ ▼ ◀ ▶ to adjust the position of the monitor.

- See "Adjusting the signal condition with a waveform" on page 24.

AUTO ADJUST

You can switch on/off the automatic adjustment system in each items.

Items	Default setting
BLACK LEVEL ADJUST	ON
WHITE LEVEL ADJUST	ON
RGB ADJUST (BLACK)	OFF
RGB ADJUST (WHITE)	OFF

1. Press ▲ ▼ and select the required item.
2. Press ◀ ▶ and switch on/off.
3. Press ▲ ▼ and select **AUTO** and press **ENTER**.
 - The confirmation screen will be displayed.
4. Press ◀ ▶ and select **OK**.
5. Press **ENTER**.

NOTE:

- When the **WAVEFORM MONITOR** is set to **OFF**, the **AUTO ADJUST** is not displayed.

SPLIT ADJUST

You can perform image adjustment in some **PICTURE** menu items while displaying a certain area of the frozen image in a split window.

● SPLIT ADJUST MODE

Select the required split style from **NORMAL** and **REVERSE** in the **SPLIT ADJUST MODE** menu.

- **NORMAL**



- **REVERSE**

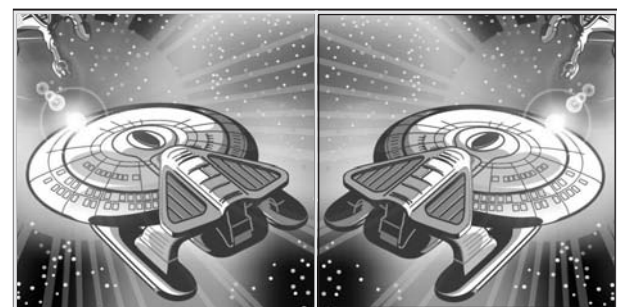

● **Adjusting the image in a split window**

1. Select **AREA SELECT** and press the **ENTER** button.
 - The image will be frozen and the area cursor will be displayed.

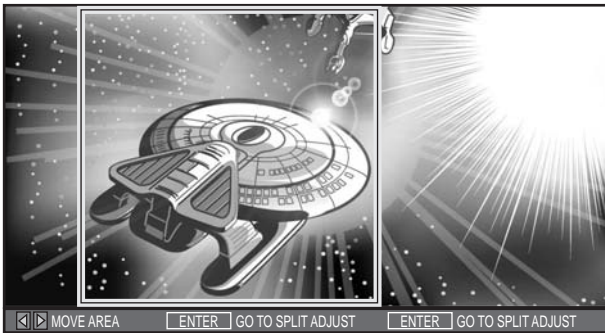

2. Press **◀▶** to move the area cursor to select the required area and press the **ENTER** button.
 - The selected frozen image will be displayed in a split window.
3. Press the **MENU** to display the **PICTURE** menu on the right.

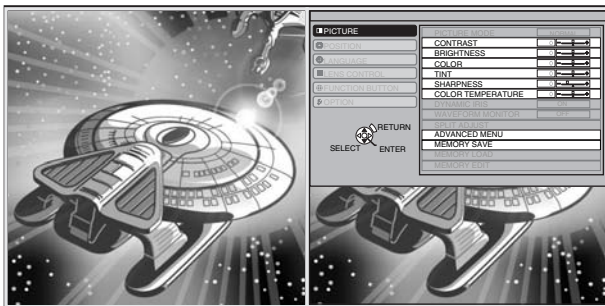

4. Adjust the required **PICTURE** menu items.
 - The Other menu items are not available.
 - Sub-menu items vary according to the selected input signal. See "Main menu and sub-menu" on page 28.
5. Press **MENU/RETURN** button several times to escape from the menu.
6. Press the **ENTER** button.
 - The confirmation screen will be displayed. Select **OK** to finish the adjustment.
7. Press the **ENTER** button.
 - Press the **ENTER** button again to return to the **AREA SELECT**.
 - Press the **RETURN** button escape from the **SPLIT ADJUST** mode.

ADVANCED MENU

You can perform more detailed image adjustment manually.

■ **GAMMA**

You can adjust linear intensity at 3 levels. Press **◀▶** to increase/decrease 1 point.

Levels	Default setting
GAMMA HIGH	0
GAMMA MID	0
GAMMA LOW	0

- Setting range: -8 to +8

■ **CONTRAST**

You can adjust the amount of contrast in RGB colors individually. Press **◀▶** to increase/decrease 1 point.

RGB	Default setting
CONTRAST R	0
CONTRAST G	0
CONTRAST B	0

- Setting range: -32 to +32

■ **BRIGHTNESS**

You can adjust the brightness in RGB colors individually. Press **◀▶** to increase/decrease 1 point.

RGB	Default setting
BRIGHTNESS R	0
BRIGHTNESS G	0
BRIGHTNESS B	0

- Setting range: -16 to +16

■ **NR (Noise Reduction)**

You can switch the automatic noise reduction system on/off. Press **◀▶** to select the required setting.

- **ON:** Automatic noise reduction
- **OFF:** No noise reduction

■ **MPEG NR**

You can switch the automatic noise reduction system for MPEG format images on/off. The system minimize block noise and mosquito noise to eliminate jagged edges, providing an overall smoother image. Press **◀▶** to select the required setting.

- **ON:** Active
- **OFF:** Deactive

NOTE:

- **MPEG NR** system is not available with **COMPUTER/HDMI (VGA60)** signals.

PICTURE menu

COLOR MANAGEMENT

You can manage your own defined color settings. See "Setting your own color profile" on page 26.

xvYCC

You can switch on/off the automatic adjustment system for signals which complied with xvYCC.

- **ON:** Active
- **OFF:** Deactive

NOTE:

- xvYCC adjustment system is only available with HDMI signals in **COLOR1** of **PICTURE MODE** menu.

DETAIL CLARITY

You can switch on/off the automatic detail clarity system.

- **ON:** Active
- **OFF:** Deactive

CINEMA REALITY

You can switch the automatic image synchronizer on/off for 24 frames a second images, such as movies. Press ◀ ▶ to select the required setting.

- **ON:** Active
- **OFF:** Deactive

NOTE:

- **CINEMA REALITY** is effective only with interlace signals.

TV-SYSTEM

When the video signal is changed, the setting switches automatically.

You can switch the setting manually to match the video data. Press ◀ ▶ to cycle through the options.

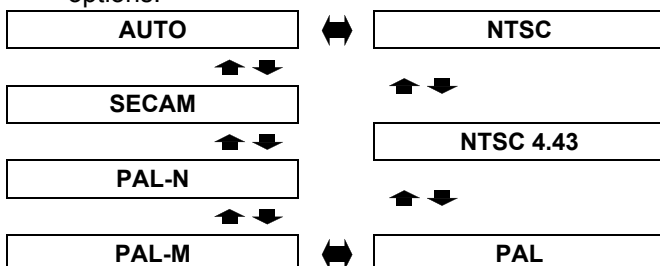

NOTE:

- **AUTO** setting will select from **NTSC/NTSC 4.43/PAL/PAL60/PAL-M/PAL-N/SECAM**.

MEMORY SAVE

You can save and name the adjusted **PICTURE** menu settings for instant access from **MEMORY LOAD** menu.

1. Adjust the items in **PICTURE** menu.
2. Select **MEMORY SAVE** and press the **ENTER** button.
3. Select the required memory setting and press the **ENTER** button.
 - The confirmation screen will be displayed. Select **OK** and press the **ENTER** button.
 - Indicated with ★ is in use, and ☆ is empty.
4. Use ▲ ▼ ◀ ▶ to specify the location of the required character to enter and press the **ENTER** button.
 - You can enter up to 16 characters.

MEMORY NAME INPUT

A	B	C	D	E	F	G	H	I	J	K	L	M	ALL DELETE		
N	O	P	Q	R	S	T	U	V	W	X	Y	Z			
a	b	c	d	e	f	g	h	i	j	k	l	m			
n	o	p	q	r	s	t	u	v	w	x	y	z			
0	1	2	3	4	5	6	7	8	9	SPACE					
!	"	#	\$	%	&	'	*	+	-	/	=	?@		\	^
_	`		~	()	<	>	[]	{	}	,	.	;	

OK
CANCEL

5. Repeat step 4 until you finish the text line.
 - Move the cursor to **ALL DELETE** and press the **ENTER** button to delete all the entered text line.
 - Press the **DEFAULT** button to delete the last entered character or indicated with cursor in the text box.
 - To insert a character in the entered text line, move the cursor to the text box to select the required place and press ▼ then perform step 4.
6. Select **OK** and press the **ENTER** button to set the entered text as a name.

NOTE:

- If you leave the text box empty and save, the default memory number will stay as a name.

MEMORY LOAD

You can access the saved settings instantly. See "Loading a saved setting" on page 23.

1. Select a setting from **MEMORY1 - 16**.
 - Undefined settings will not be selectable.
2. Press **ENTER** to activate.

NOTE:

- If you have not saved any settings, **MEMORY1 - 16** will not be displayed.

MEMORY EDIT

You can edit the named memory settings.

● Deleting a memory setting

1. Select **MEMORY DEL** and press the **ENTER** button.
2. Select the required memory setting and press the **ENTER** button.
 - If you select **ALL DELETE**, you can delete all of the saved memory settings.
3. Select **OK** in the confirmation screen and press the **ENTER** button.

● Changing the name of the memory setting

1. Select the required memory setting and press the **ENTER** button.
2. Use **▲ ▼ ◀ ▶** to specify the location of the required character to enter and press the **ENTER** button.
 - You can enter up to 16 characters.

MEMORY NAME INPUT

[Empty text input field]																		
A	B	C	D	E	F	G	H	I	J	K	L	M	ALL DELETE					
N	O	P	Q	R	S	T	U	V	W	X	Y	Z						
a	b	c	d	e	f	g	h	i	j	k	l	m						
n	o	p	q	r	s	t	u	v	w	x	y	z						
0	1	2	3	4	5	6	7	8	9	SPACE								
!	"	#	\$	%	&	'	*	+	-	/	=	?	@	\	^			
_	`		~	()	<	>	[]	{	}	,	.	:	;			
OK						CANCEL												

3. Repeat step 4 until you finish the text line.
 - Move the cursor to **ALL DELETE** and press the **ENTER** button to delete all the entered text line.
 - Press the **DEFAULT** button to delete the last entered character or indicated with cursor in the text box.
 - To insert a character in the entered text line, move the cursor to the text box to select the required place and press **▼** then perform step 4.
4. Select **OK** and press the **ENTER** button to set the entered text as a name.

NOTE:

- If you have not saved any settings, **MEMORY1 - 16** will not be displayed.

SIGNAL MODE

The current selected signal will be displayed. This is available with signals from **COMPUTER IN/COMPONENT IN/HDMI IN** only.

NOTE:

- See "List of compatible signals" on page 47.

POSITION menu

Remote control



Control panel

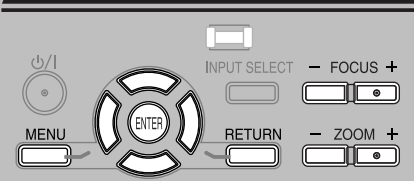

- See "Navigating through the MENU" on page 30.
- See "Main menu and sub-menu" on page 28.

H-POSITION

You can move the projected image horizontally for fine adjustment.



V-POSITION

You can move the projected image vertically for fine adjustment.



DOT CLOCK

If you have interference patterns of the projected image, which is sometimes referred to as moire or noise, you can minimize it by pressing ◀ ▶ to adjust the clock frequency. (Available with signals from **COMPUTER IN** only)

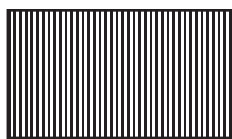

NOTE:

- If the projecting signal's dot clock frequency is higher than 150 MHz, the adjustment may not make a difference.
- **DOT CLOCK** needs to be adjusted before adjusting the **CLOCK PHASE**.

CLOCK PHASE

If you require further adjustment for the same reason as the **DOT CLOCK** adjustment, you can fine adjust the timing of the clock. Press ◀ ▶ to adjust. (Available with signals from **COMPUTER IN/COMPONENT IN** only)

NOTE:

- If the projecting signal's dot clock frequency is higher than 150 MHz, the adjustment may not make a difference.
- Available signals from **COMPONENT IN**:
1 125 (1 080)/60i, 1 125 (1 080)/50i, 1 125 (1 080)/60p,
1 125 (1 080)/50p, 1 125 (1 080)/24p, 750 (720)/60p

ASPECT

You can switch the aspect ratio manually when needed.

Aspect ratio depend on signals

Press ◀ ▶ to cycle through the aspect ratio options. The cycle pattern depends on the connected signals.

VIDEO/ S-VIDEO	4:3 → 16:9 → 14:9 → ZOOM1 → ZOOM2 → JUST AUTO → 4:3 → 16:9 → JUST → ZOOM NTSC signal
COMPUTER (RGB)	4:3 → 16:9 4:3 → 16:9 VGA or SVGA signals Not switchable WIDE480/600/720/768/768-2/800/900 signals
HDMI	4:3 → 16:9 16:9 → H - FIT → V - FIT → ZOOM 1 125 (1 080)/50i, 1 125 (1 080)/60i, 1 125 (1 080)/50p, 1 125 (1 080)/60p, 1 125 (1 080)/24p, 750 (720)/50p and 750 (720)/60p signals 4:3 → 16:9 → JUST → ZOOM 525p (480p) and 625p (576p) signals
COMPONENT (YPBPR)	4:3 → 16:9 → 14:9 → JUST → ZOOM1 → ZOOM2 625i (576i), 625p (576p) AUTO → 4:3 → 16:9 → JUST → ZOOM 525i (480i), 525p (480p) 16:9 → H - FIT → V - FIT 1 125 (1 080)/50i, 1 125 (1 080)/60i, 1 125 (1 080)/50p, 1 125 (1 080)/60p, 1 125 (1 080)/24p, 750 (720)/50p, 750 (720)/60p signals

Aspect ratio options and projection example

If you apply the aspect ratio options to the projected image, the result will be as follows. The result may differ due to the input signals. See “Switching the aspect ratio” on page 23.

VIDEO/S-VIDEO/COMPONENT

Not available with 1 125 (1 080)/50i, 1 125 (1 080)/60i, 1 125 (1 080)/50p, 1 125 (1 080)/60p, 1 125 (1 080)/24p, 750 (720)/50p and 750 (720)/60p signals.

Original size		4:3	Squeeze signal	16:9 Letter box	14:9 Letter Box	2.35:1 Cinescope
4:3	Projects at 4:3.					
16:9	Adjusts horizontally to 16:9.					
JUST	Adjusts horizontally to fit 16:9. Closer to edge, more enlarged. Not available with COMPUTER signals.					
ZOOM/ ZOOM1	Adjusts to 16:9 size with preserving original ratio. Escape the menu mode and press ▲▼ to adjust vertically.					
ZOOM2	Adjusts to cinescope size not including letter box. Escape the menu mode and press ▲▼ to adjust vertically.					
14:9	Adjusts to 14:9.					

COMPONENT signals

Available with 1 125 (1 080)/50i, 1 125 (1 080)/60i, 1 125 (1 080)/50p, 1 125 (1 080)/60p, 1 125 (1 080)/24p, 750 (720)/50p and 750 (720)/60p signals

Original Size		4:3	16:9	Cinescope
H - FIT	Adjusts horizontally to 16:9.			
V - FIT	Adjusts to 16:9 vertically. Escape and press ▲ ▼ to scroll the image to adjust the edge vertically.			
ZOOM	Adjusts to 16:9 size with preserving original ratio. Escape the menu mode and press ▲▼ to adjust vertically.			

POSITION menu

WSS

WSS (Wide Screen Signalling) detects if a **PAL/625p (576p)/625i (576i)** signal is input and that signal has an identification signal, and switch the aspect ratio to required setting automatically. You can switch the system off manually.

OVER SCAN

If the 4 edges of an image is partly dropped, you can use this function to adjust and project it properly.

- Setting range: 0 to +10
- **OVER SCAN** is not available with **COMPUTER** signals.



KEYSTONE

If the projector is aligned non-perpendicularly to the screen, or if the projection screen has an angled surface, you can vertically correct keystone.

Image	Operation

- Setting range: -32 to 32

NOTE:

- You can correct the distortion ± 30 degrees from the vertical plane. For a better quality image, installing the projector with a minimum of distortion is recommended.
- Some distortion may be retained for the lens shift adjustment.
- The distortion of the main menu screen is not correctable.
- The result of the keystone correction will affect the aspect ratio and the size of the image.

AUTO SETUP

You can adjust **V - POSITION**, **H - POSITION**, **DOT CLOCK** and **CLOCK PHASE** automatically when connecting via **COMPUTER IN**. Press **ENTER** to adjust these at the same time.

LENS CONTROL

Remote control

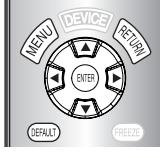

Control panel

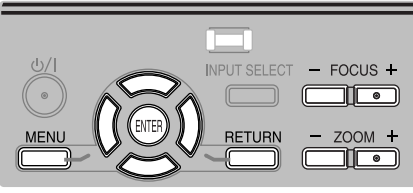

- See “Navigating through the MENU” on page 30.
- See “Main menu and sub-menu” on page 28.

ZOOM/FOCUS

You can use the 2 different test patterns to adjust the focus and zoom of the image. See “Lens shift and positioning” on page 16.

1. Press **ENTER** to display test pattern 1.
 - Press ▲ ▼ to adjust the focus and ◀ ▶ to adjust the zoom.

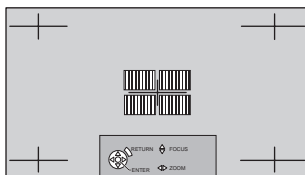

2. Press **ENTER** to display test pattern 2.
 - Press ▲ ▼ to adjust the focus and ◀ ▶ to adjust the zoom.

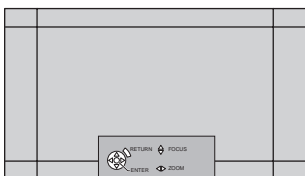

3. Press **ENTER** to display the projected image.
 - You can confirm the adjustment is fit to the projected image.
4. Press **MENU** or **RETURN** to return to the previous menu, or press repeatedly to escape the menu mode.

NOTE:

- When the projector and/or the screen is tilted, adjust the focus at the center of the image. The upper and lower edge might be out of focus.
- When the image is distorted in keystone, adjust the **KEYSTONE** in **POSITION** menu.

FUNCTION BUTTON

Remote control



Control panel

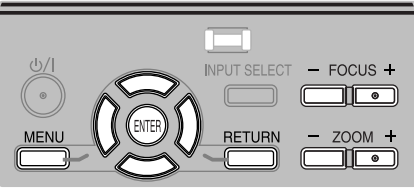

- See “Navigating through the MENU” on page 30.
- See “Main menu and sub-menu” on page 28.

BUTTON1/2/3

You can assign certain menu options to the 3 function buttons for instant operation.

1. Select the required button from **BUTTON1**, **BUTTON2** or **BUTTON3** and press the **ENTER** button.
2. Press ▲ ▼ ◀ ▶ to select the required menu options and press the **ENTER** button.

HDMI 1 IN	NORMAL
HDMI 2 IN	DYNAMIC
HDMI 3 IN	COLOR1
COMPUTER IN	COLOR2
COMPONENT 1 IN	CINEMA1
COMPONENT 2 IN	CINEMA2
S-VIDEO IN	CINEMA3
VIDEO IN	SPLIT ADJUST
BLANK	WAVEFORM AUTO ADJUST
AUTO SETUP	MEMORY LOAD
CONTRAST	BRIGHTNESS
CONTRAST R	BRIGHTNESS R
CONTRAST G	BRIGHTNESS G
CONTRAST B	BRIGHTNESS B

- **BLANK function**
You can stop the projection temporary for electrical power save. Press any button except the **LIGHT** and learning remote control buttons.

OPTION menu

Remote control



Control panel

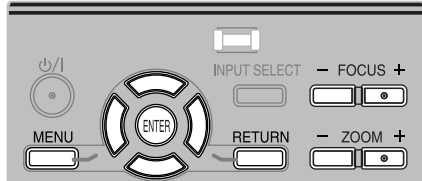

- See "Navigating through the MENU" on page 30.
- See "Main menu and sub-menu" on page 28.

INPUT GUIDE

When you change the input method, the guidance appears in the upper right corner of the screen. The following display methods are available. Press ◀ ▶ to cycle through the options.

Options	Function
OFF	Turn off the guidance.
SIMPLE	Display the input method by text. The INPUT GUIDE will go out after 5 seconds without any operation.
DETAILED	Display the input method by graphic. The INPUT GUIDE will go out after 10 seconds without any operation.

OSD DESIGN

You can change the background color of the menu. Press ◀ ▶ to cycle through the options.

- **TYPE1** Semi transparent black
- **TYPE2** Solid blue
- **TYPE3** Semi transparent dark blue

OSD POSITION

You can change the position where to display the menu. Press ◀ ▶ to cycle through the options.

UPPER LEFT	UPPER CENTER	UPPER RIGHT
	CENTER	
LOWER LEFT	LOWER CENTER	LOWER RIGHT

BACK COLOR

You can choose a screen color from **BLUE** or **BLACK** for when the projector is in idle. Press ◀ ▶ to select.

STARTUP LOGO

You can switch the logo on/off that is displayed when starting up the projector. Press ◀ ▶ to select the required option. **STARTUP LOGO** will be displayed for 30 seconds.

- **ON** Active
- **OFF** Deactive

AUTO SEARCH

When the projector is turned on, the input terminals are detected and an input signal is selected automatically. You can switch the system on/off. Press ◀ ▶ to cycle through the options.

- **ON** Active
- **OFF** Deactive

NOTE:

- When no signal is detected, the last used input will be selected.

HDMI SIGNAL LEVEL

When an **HDMI IN** is selected, you can switch the **HDMI** signal **NORMAL** or **EXPAND** to display the image. Press ◀ ▶ to select an option.

- **NORMAL** For general HDMI equipment
- **EXPAND** For HDMI equipment with expanded signals.

NOTE:

- **HDMI SIGNAL LEVEL** is not available with some equipment.

FRAME RESPONSE

You can minimize the time delay of image displaying for the interlace signals.

- **NORMAL** Prioritize the image quality
- **FAST** Prioritize the frame response

INSTALLATION

When installing the projector, select the projection method according to the projector position. Press ◀ ▶ to cycle through the options. See “Projection method” on page 15.

FRONT/DESK	Setting on a desk/floor and projecting from front
FRONT/CEILING	Mounting in the ceiling and projecting from front
REAR/DESK	Setting on a desk/floor and projecting from rear
REAR/CEILING	Mounting in the ceiling and projecting from rear

SLEEP

You can select the required duration of time and set the off timer to turn off the power of the projector automatically. 3 minutes before turn-off, the countdown of minutes will be displayed in the lower right corner. Press ◀ ▶ to cycle through the options. See “Switching off the projector automatically” on page 25.

ALTITUDE

If you use the projector at high elevation, the **ALTITUDE** setting need to be **HIGH** to set the fan speed high. Press ◀ ▶ to select the required option.

- **LOW** The fan speed is low.
- **HIGH** The fan speed is high.

NOTE:

- At 1 400 m (4 593 ft) above sea level, the setting must be **HIGH**.
- The loudness of fan noise depends on the **ALTITUDE** setting.

LAMP POWER

You can adjust the power of the lamp to save on electricity, prolong the lamp life and reduce the noise.

Options	Function
NORMAL	When higher luminance is required.
ECO-MODE	When lower luminance is sufficient.

NOTE:

- When no input signal is detected, the function is disabled.

LAMP RUNTIME

You can check how long the lamp has been used.

NOTE:

- **LAMP RUNTIME** is a relevant matter for lamp replacement timing. See “Replacing the lamp unit” on page 44.

TEMP and LAMP Indicators

Managing the indicated problems

If a problem should occur with the projector, the **LAMP** and/or **TEMP** indicators will inform you. Manage the indicated problems as follow.

1. Confirm the status of all indicators and projector, and switch off the projector in proper way.
2. Find out the cause of the problem by status of the **LAMP** and/or **TEMP** indicators.
3. Follow the following instruction for each indication and solve the problem.
4. Turn on the projector in the correct way and confirm the indicator is not indicating a problem any longer.

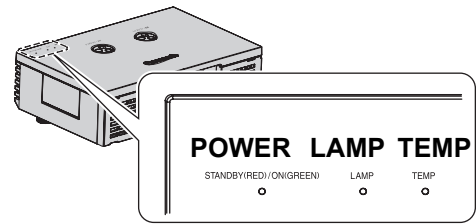

NOTE:

- If no problem is found or the problem remains, do not turn on the projector. Instead contact an Authorized Service Center.

LAMP indicator

Indicator	● Illuminating red	● Flashing red		
Problem	LAMP RUNTIME has reached 1 800 hours.	The lamp circuit failure, abnormal function or lamp unit is damaged.		
Cause	The lamp unit will run out soon and needs to be replaced.	The MAIN POWER is switched on again before the lamp unit is cooled enough.	The lamp circuit failure, abnormal function.	The lamp unit is damaged.
Remedy	See “Replacing the lamp unit” on page 44.	Let the lamp unit cool down and turn on the MAIN POWER .	Contact an Authorized Service Center.	See “Replacing the lamp unit” on page 44.

TEMP indicator

Indicator	● Illuminating red and still projecting ● Flashing red and the POWER button is turned off			
Problem	The temperature inside and/or outside the projector is abnormally high.			
Cause	The ventilation openings are covered.	The room temperature is too high.	The air filter is excessively dirty and the ventilation is poor.	The projector is located at high elevations (above 1 400 m).
Remedy	Remove the object(s) from the ventilation openings or clear around the projector.	Reinstall the projector in temperature controlled place. See page 52.	Replace the air filter in the proper method. See page 43.	Turn on the projector and set the ALTITUDE to HIGH . See page 41.

Maintenance

Care and Replacement

Cleaning the projector

Before cleaning the projector

- Switch off the **MAIN POWER** switch in proper way and disconnect the power plug from the wall outlet.
- Unplug all the cables from the projector.

Cleaning the outer surface of the projector

Wipe off dirt and dust gently with a soft cloth.

- If it is difficult to remove the dirt, soak a cloth in a neutral detergent diluted with water, wring the cloth well and then wipe the projector. Dry off the projector with dry cloth.
- If you use a chemical treated wipe, follow the instructions supplied with it.

Cleaning the lens surface

Wipe off dirt and dust gently with a lint-free cloth.

- Make sure no dirt or dust remains on the surface of the lens. It will be enlarged and projected onto a screen.

Cleaning the air filter

If the air filter is excessively dirty, the internal temperature of the projector increases and may cause malfunction. Clean the air filter regularly every 100 hours of usage.

1. Place a finger at the bottom of the air filter
2. Slightly push up and pull out the air filter to remove.

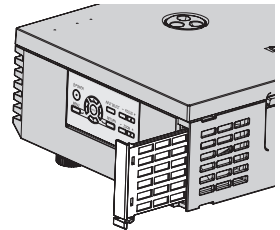

3. Vacuum dirt and dust from the air filter.

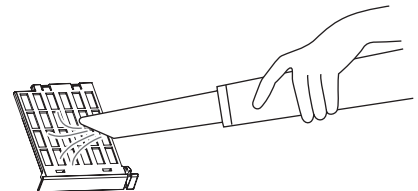

- Do not wash the air filter.
4. Place and slightly slide in the air filter in the air intake port to attach.
 - Make sure the air filter clicks into the place.

NOTE:

- Do not use the projector without attaching the air filter.

Replacing the air filter

The air filter should be replaced when cleaning is ineffective and when replacing the lamp unit. A replacement air filter is provided with a replacement lamp unit, ET-LAE1000. Contact an Authorized Service Center for the optional air filter.

Care and Replacement

Replacing the lamp unit

Before replacing the lamp unit



- Switch off the **MAIN POWER** button in proper way and disconnect the power plug from the wall outlet.
- Make sure the lamp unit and the surroundings are cooled enough.
- Unplug all the cables from the projector.
- Prepare a Phillips-head screwdriver.
- Contact an Authorized Service Center to purchase a replacement lamp unit (ET-LAE1000).
- When the projector is mounted in the ceiling, do not work directly under the projector or put your face closer to the projector.

NOTE:

- Prior to replacing the lamp unit, allow it to cool down to prevent the risk of burns, damage and other hazards.
- Do not attempt replacement with an unauthorized lamp unit.

When to replace the lamp unit

The lamp unit is consumable and the brightness decreases by duration of usage. The **LAMP** indicator will inform you of the replacement timing at 1 800 hours, and at 2 000 hours, the projector will be turned off. Those figures are rough guidance and might be shortened by the usage conditions, characteristics of the lamp unit, environmental conditions, and so on. You can check the duration of usage time using **LAMP RUNTIME** in the **OPTION** menu.

Indication	On screen	LAMP indicator
		
Over 1 800 hours	<p>“REPLACE LAMP” is displayed on the upper left of the screen for 30 seconds. To clear the screen immediately, press any button.</p>	Illuminates red.
Over 2 000 hours	<p>“REPLACE LAMP” is displayed on the upper left of the screen, and it will stay until you respond. To clear the screen, press any button.</p>	

NOTE:

- The guide times, 1 800 and 2 000 hours, are rough estimates based on certain conditions and is not a guaranteed time. The estimated condition is: **LAMP POWER** in **OPTION** menu set to **NORMAL**.
- To prolong the lamp life, set the **LAMP POWER** in **OPTION** menu to **ECO-MODE**. See “LAMP POWER” on page 41.
- For more information about the lamp unit, such as guaranteed time, see the instructions which is provided with the lamp unit.

Opening the top cover

1. Hold at the back corner of the top cover and slightly push up to open.
2. Unhook the top cover safety hook from the projector.
3. Hold the top cover up and press one of the buttons of the hinge parts each to remove.
 - When the projector is mounted in the ceiling, removing the hinge parts is not required.
4. Remove the top cover aside.

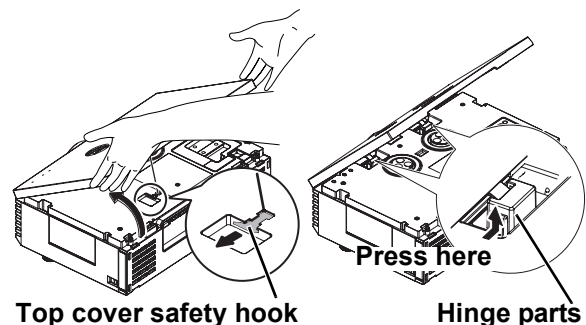

NOTE: When the projector is mounted in the ceiling;

- Place yourself at back side of the projector, then open and close the top cover.
- Do not work directly under the projector or put your face closer to the projector.

Removing and replacing the lamp unit

1. Use a Phillips screw driver to loosen the 3 lamp unit fixing screws until the screws turn freely.
2. Hold the handle of the lamp unit and release the lamp unit lock.
3. Pull out the lamp unit gently from the projector.
4. Replace the new lamp unit while making sure that the direction of insertion is correct.
 - Press the top of the lamp unit and make sure the unit is installed securely.
5. Tighten the lamp unit fixing screws securely with a Phillips screwdriver.

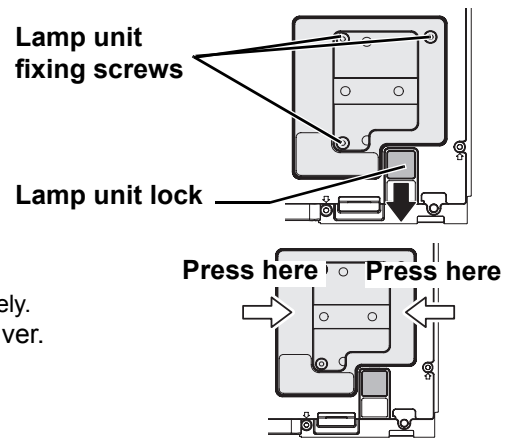

Attaching the top cover

1. Attach the hinge parts of the top cover to the projector and press slightly until it clicks.
 - When the projector is mounted in the ceiling, attaching the hinge parts is not required.
2. Hook the top cover safety hook to the projector.
3. Hooking the tabs of the top cover to the front of the projector and lift down slowly.
4. Press the back corner of the top cover gently until it clicks.
 - Make sure to hook the top cover safety hook to the body.

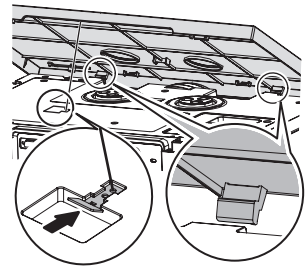

NOTE:

- Be sure to install the lamp unit and the top cover of the projector securely. If they are not securely installed, it may cause the protection circuit to operate so that the power cannot be turned on.
- Grip the handle and keep the lamp unit paralleled when you remove the lamp unit. Some parts of the lamp unit are sharpened and may cause injury.
- Do not switch the power on while the top cover is opened.
- When the projector is mounted in the ceiling, keep the lamp unit paralleled up and remove.

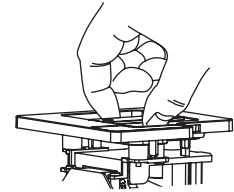

Resetting the LAMP RUNTIME

If the lamp usage time has passed 2 000 hours (when **LAMP POWER** has been set to **NORMAL**), the projector will switch to standby mode after approximately 10 minutes of operation. The resetting procedure should thus be completed within 10 minutes.

1. Connect the power cord to the projector and a wall outlet, and switch the **MAIN POWER** on.
2. Switch the **POWER** button.
3. Press the **MENU** button to display the menu.
4. Press **▲ ▼** to select **OPTION** and press **ENTER**.
5. Press **▲ ▼** to select **LAMP RUNTIME**.
6. Press and hold the **ENTER** button for approximately 3 seconds.
7. The confirmation screen will be displayed and select **OK**.
8. Switch off the **POWER** button to reset the duration of the **LAMP RUNTIME**.
9. Confirm the duration of time in **LAMP RUNTIME** is reset to "0".

ALTITUDE	LOW
LAMP POWER	NORMAL
LAMP RUNTIME	1820H

Troubleshooting

Should any problem persist, contact your dealer.

Problem	Cause	Reference page
Power does not turn on.	<ul style="list-style-type: none"> ● The power cord may not be connected. ● The MAIN POWER switch is turned off. ● No electric supply is at the wall outlet. ● TEMP indicator is lit or flashes. ● LAMP indicator is lit or flashes. ● The lamp unit cover has not been securely installed. ● The circuit breakers have tripped. 	<p>19 20 19 42 42 44 -</p>
No picture appears.	<ul style="list-style-type: none"> ● The video signal input source may not be connected to a terminal properly. ● The input selection setting may not be correct. ● The BRIGHTNESS adjustment setting may be at the minimum setting. ● The SHUTTER function may be in use. ● The lens cover may still be attached to the lens. 	<p>18 23 31 39 12</p>
The picture is fuzzy.	<ul style="list-style-type: none"> ● The lens focus may not have been set correctly. ● The projector may not be at the correct distance from the screen. ● The lens may be dirty. ● The projector may be tilted too much. 	<p>21 14 10 16</p>
The color is pale or grayish.	<ul style="list-style-type: none"> ● COLOR or TINT adjustment may be incorrect. ● The input source which is connected to the projector may not be adjusted correctly. 	<p>31 28</p>
The Remote control does not operate.	<ul style="list-style-type: none"> ● The batteries may be weak. ● The batteries may not have been inserted correctly. ● The remote control signal receptor on the projector may be obstructed. ● The remote control unit may be out of the operation range. 	<p>- 11 22 22</p>
The picture does not display correctly.	<ul style="list-style-type: none"> ● The signal format (TV-SYSTEM) may not have been set correctly. ● There may be a problem with the VCR or other signal source. ● A signal which is not compatible with the projector is being input. 	<p>34 - 47</p>
Picture from a computer does not appear.	<ul style="list-style-type: none"> ● The cable may be longer than the optional cable. ● The external video output from a laptop computer may not be correct. (You may be able to change the external output settings by pressing the [Fn] + [F3] or [Fn] + [F10] keys simultaneously. The actual method varies depending on the type of computer; refer to the documentation provided with your computer for further details.) 	<p>- 48</p>

Technical Information

List of compatible signals

Mode	Display	Display resolution (dots) *1	Scanning frequency		Dot clock frequency (MHz)	Picture quality *2	Terminals
			H (kHz)	V (Hz)			
NTSC/NTSC 4.43/ PAL-M/PAL60	-	720 x 480i	15.7	59.9	-	A	VIDEO/S-VIDEO
PAL/PAL-N/SECAM	-	720 x 576i	15.6	50.0	-	A	
525i (480i)	525i	720 x 480i	15.7	59.9	13.5	A	COMPONENT
625i (576i)	625i	720 x 576i	15.6	50.0	13.5	A	
525p (480p)	525p	720 x 483	31.5	59.9	27.0	A	COMPONENT/HDMI
625p (576p)	625p	720 x 576	31.3	50.0	27.0	A	
1 125 (1 080)/60i	1 125/60i	1 920 x 1 080i	33.8	60.0	74.3	AA	COMPONENT/ HDMI/COMPUTER
1 125 (1 080)/50i	1 125/50i	1 920 x 1 080i	28.1	50.0	74.3	AA	
1 125 (1 080)/24p	1 125/24p	1 920 x 1 080	27.0	24.0	74.3	AA	COMPONENT/HDMI
1 125 (1 080)/60p	1 125/60p	1 920 x 1 080	67.5	60.0	148.5	AA	
1 125 (1 080)/50p	1 125/50p	1 920 x 1 080	56.3	50.0	148.5	AA	COMPONENT/ HDMI/COMPUTER
750 (720)/60p	750/60p	1 280 x 720	45.0	60.0	74.3	AA	
750 (720)/50p	750/50p	1 280 x 720	37.5	50.0	74.3	AA	COMPONENT/HDMI
VGA480	VGA60	640 x 480	31.5	59.9	25.2	A	
	VGA75	640 x 480	37.5	75.0	31.5	A	COMPUTER
	VGA85	640 x 480	43.3	85.0	36.0	A	
	VGA138	640 x 480	72.1	138.0	62.3	A	
WIDE480	WIDE480	856 x 480	30.1	60.1	31.5	A	
SVGA	SVGA55	800 x 600	35.2	56.3	36.0	A	
	SVGA60	800 x 600	37.9	60.3	40.0	A	
	SVGA70	800 x 600	48.1	72.2	50.0	A	
	SVGA75	800 x 600	46.9	75.0	49.5	A	
	SVGA85	800 x 600	53.7	85.1	56.3	A	
WIDE600	WIDE600	1 072 x 600	37.2	59.9	51.4	A	
WIDE720	WIDE720	1 280 x 720	45.1	60.1	76.5	AA	
XGA	XGA60	1 024 x 768	48.4	60.0	65.0	A	
	XGA70	1 024 x 768	56.5	70.1	75.0	A	
	XGA75	1 024 x 768	60.0	75.0	78.8	A	
	XGA85	1 024 x 768	68.7	85.0	94.5	A	
	XGA89	1 024 x 768	72.1	89.0	99.2	A	
WIDE768	WIDE768	1 280 x 768	45.3	56.5	76.2	A	
MXGA	MXGA70	1 152 x 864	64.0	71.2	94.2	A	
	MXGA75	1 152 x 864	67.5	74.9	108.0	A	
SXGA	SXGA60	1 280 x 1 024	64.0	60.0	108.0	A	
SXGA60+	SXGA60+	1 400 x 1 050	65.1	59.9	122.4	A	
WIDE768-2	WIDE768-2	1 360 x 768	48.8	59.8	74.3	A	
WIDE800	WIDE800	1 280 x 800	49.7	59.8	83.5	A	
WIDE900	WIDE900	1 440 x 900	55.9	59.8	106.5	A	

*1. The "i" appearing after the resolution indicates an interlaced signal.

*2. The following symbols are used to indicate picture quality.

AA Maximum picture quality can be obtained.

A Signals are converted by the image processing circuit before picture is projected.

Technical Information

Serial terminal

The serial connector which is on the connector panel of the projector conforms to the RS-232C interface specification, so that the projector can be controlled by a personal computer which is connected to this connector.

Connection

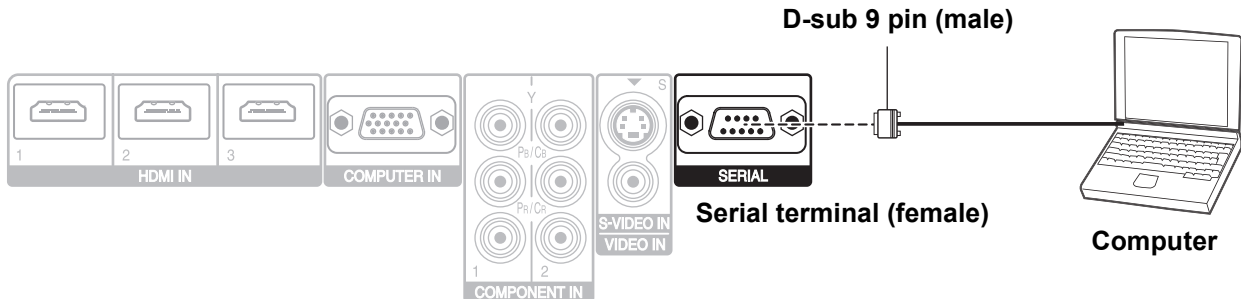

NOTE:

- You must use only an RS-232C Serial Interface Cable with a ferrite core, type ET-ADSER.

Pin assignments and signal names

	Pin No.	Signal name	Contents
	①		NC
	②	TXD	Transmitted data
	③	RXD	Received data
	④		NC
	⑤	GND	Earth
	⑥		NC
	⑦	RTS	Connected internally
	⑧	CTS	
	⑨		NC

Cable specifications

(When connected to a personal computer)

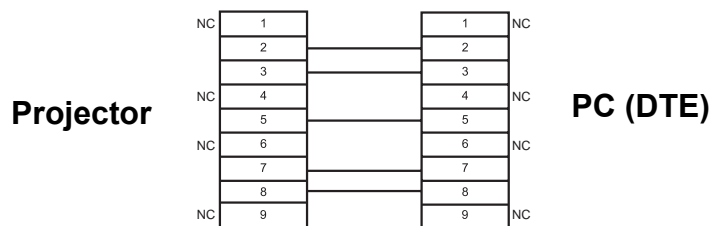

Basic format

STX	Command	:	Parameter	ETX
Start byte (02h)	3 bytes	1 byte	1 byte - 4 bytes	End (03h)

The data streaming from the computer will start with STX, and proceed to Command, Parameter and end with ETX. You can add the required parameter.

- The projector can not receive any command for 10 seconds after the lamp is switched on. Wait 10 seconds before sending the command.
- If sending multiple commands, check that a response has been received from the projector for one command before sending the next command.
- When a command which does not require parameters to be sent, the colon (:) is not required.
- If an incorrect command is sent from the personal computer, the ER401 command will be sent from the projector to the personal computer.

Communication settings

Signal level	RS-232C	Character length	8 bits
Sync. method	Asynchronous	Stop bit	1 bit
Baud rate	9 600 bps	X parameter	None
Parity	None	S parameter	None

Control commands

Command	Control contents	Remarks
PON	POWER ON	In standby mode, all commands other than the PON command are ignored. The PON command is ignored during lamp ON control.
POF	POWER OFF	If a PON command is received while the cooling fan is operating after the lamp has switched off, the lamp is not turned back on again straight away in order to protect the lamp.
IIS	INPUT	Parameter: CP1 = COMPONENT1 IN CP2 = COMPONENT2 IN SVD = S-VIDEO IN VID = VIDEO IN HD1 = HDMI1 IN HD2 = HDMI2 IN HD3 = HDMI3 IN RG1 = COMPUTER IN
OMN	MAIN	Displaying the main menu.
OEN	ENTER	Activating the selected items in the menu mode.
OBK	RETURN	Returning to the previous menu or escaping from the menu mode.
OCU/ OCD/ OCL/ OCR	Navigation buttons	OCU = ▲ button OCL = ◀ button OCD = ▼ button OCR = ▶ button
OLE	LENS	Activating the LENS CONTROL menu.
OST	DEFAULT	Resetting to the factory default setting. (page 22)
OFZ	FREEZE	Freezing the projected screen. Parameter: 0 = OFF 1 = ON
OOT	SLEEP	Setting the duration of time to turn off the power automatically. (page 25) 0 = OFF 1 = 60min. 2 = 90min. 3 = 120min. 4 = 150min. 5 = 180min. 6 = 210min. 7 = 240min.
OSH	BLANK	Turning off the projection temporarily. Send the command to switch between ON and OFF. Do not send the command consecutively.
OVM	PICTURE	Activating the PICTURE menu. Send the command to switch menu items. (page 25)
OWM	WAVEFORM	Activating the WAVEFORM. (page 24) Parameter: 0 = OFF 1 = FULL SCAN (Y) 5 = SINGLE LINE SCAN (Y) 2 = FULL SCAN (R) 6 = SINGLE LINE SCAN (R) 3 = FULL SCAN (G) 7 = SINGLE LINE SCAN (G) 4 = FULL SCAN (B) 8 = SINGLE LINE SCAN (B)
VS1	ASPECT	Switching the aspect ratio. (page 23)
VPM	PICTURE MODE	Switching the PICTURE MODE. (page 25) Parameter: NOR = NORMAL DYN = DYNAMIC CL1 = COLOR1 CL2 = COLOR2 CN1 = CINEMA1 CN2 = CINEMA2 CN3 = CINEMA3

Technical Information

■ Inquiry commands

Command	Control contents	Parameter	
QPW	Power status	000 = OFF	001 = ON
QFZ	FREEZE status	0 = OFF	1 = ON
QIN	INPUT signal status	CP1 = COMPONENT1 IN SVD = S-VIDEO IN HD1 = HDMI1 IN HD3 = HDMI3 IN	CP2 = COMPONENT2 IN VID = VIDEO IN HD2 = HDMI2 IN RG1 = COMPUTER IN
QOT	SLEEP status	0 = OFF 5 = 180min.	1 = 60min. 6 = 210min. 2 = 90min. 7 = 240min. 3 = 120min. 4 = 150min.
QPM	PICTURE MODE status	NOR = NORMAL CN1 = CINEMA1	DYN = DYNAMIC CN2 = CINEMA2 CL1 = COLOR1 CN3 = CINEMA3 CL2 = COLOR2
QSH	BLANK status	0 = OFF	
QWM	WAVEFORM status	Parameter: 0 = OFF 1 = FULL SCAN (Y) 2 = FULL SCAN (R) 3 = FULL SCAN (G) 4 = FULL SCAN (B)	5 = SINGLE LINE SCAN (Y) 6 = SINGLE LINE SCAN (R) 7 = SINGLE LINE SCAN (G) 8 = SINGLE LINE SCAN (B)

Ceiling mount bracket safeguards

The projector and the ceiling mount bracket are designed sufficiently safety though, make sure the safety cable provided with the projector is installed and attached to the bottom of the projector when mounting in the ceiling for safety and security.

NOTE:

- Even if it is guarantee period, the manufacturer is not responsible for any hazard or damage caused by using a ceiling mount bracket which is not purchased from an authorized distributors, or environmental conditions.
- Make sure to use a torque driver and do not use an electrical screwdriver or an impact screwdriver.
- Installation work of the ceiling mount bracket should only be carried by a qualified technician.
- Remove an unused ceiling mount bracket promptly.

Installing the safety cable

1. Install the ceiling mount bracket according to the Installation Instructions.
2. Loop the security cable around the ceiling mount bracket with less slack.
 - Lace the cable of the end with a latch through the loop on the other end of the cable.
3. Attach the latch on to the bottom of the projector with a provided screw.
 - Torque: 1.25 ± 0.2 N·m

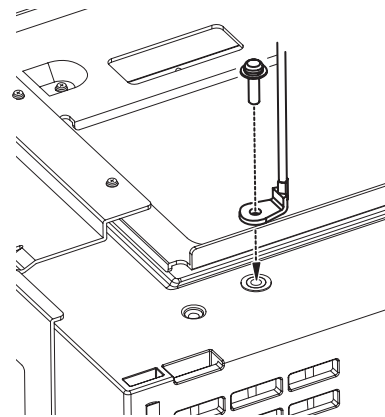
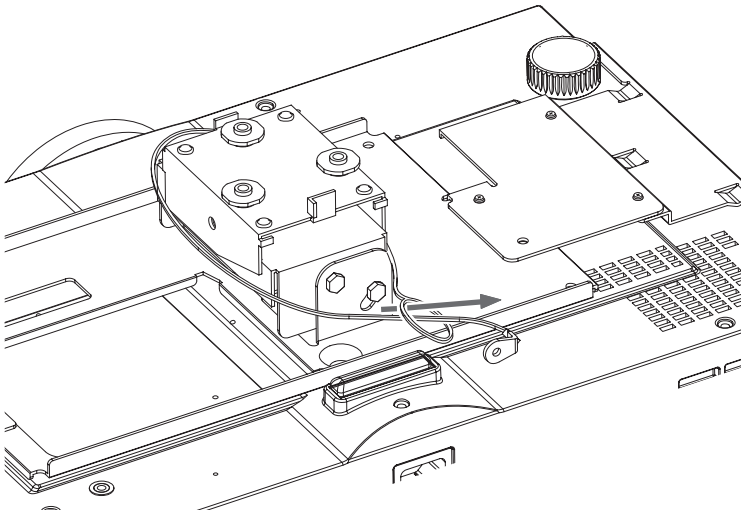

* Indicated above is ET-PKE1000S.

Technical Information

Specifications

Power supply		AC 100 - 240 V 50 Hz/60 Hz
Power consumption		240 W During standby (when fan is stopped): 0.08 W
Amps		2.8 A - 1.2 A
LCD panel	Panel size (diagonal)	0.74 type (17.78 mm)
	Aspect ratio	16 : 9
	Display method	3 transparent LCD panels (RGB)
	Drive method	Active matrix method
	Pixels	2 073 600 (1 980 x 1 080) x 3 panels
Lens		Manual zoom (2x)/Manual focus F 1.9 - 3.2, f 22.4 mm - 44.8 mm
Lamp		UHM lamp (165 W)
Luminosity		1 500 lm
Operating environment		Temperature 0 °C - 40 °C (32 °F - 104 °F) When the ALTITUDE (page 41) is set to ON: 0 °C - 35 °C (32 °F - 95 °F) Humidity 20% - 80% (no condensation)
Scanning frequency*1 (for RGB signal)	Horizontal scanning frequency	30 kHz - 70 kHz
	Vertical scanning frequency	50 Hz - 85 Hz
	Dot clock frequency	Less than 150 MHz
COMPONENT (YPbPr) signals		525i (480i), 525p (480p), 625i (576i), 625p (576p), 750 (720)/60p, 750 (720)/50p, 1 125 (1 080)/60i, 1 125 (1 080)/50i, 1 125 (1 080)/60p, 1 125 (1 080)/50p, 1 125 (1 080)/24p
Color system		7 (NTSC/NTSC 4.43/PAL/PAL-M/PAL-N/PAL60/SECAM)
Projection size		40" - 200" (1 016 mm - 5 080 mm)
Throw distance		1.2 m - 12 m (3'11" - 39'4")
Screen aspect ratio		16 : 9
Installation		FRONT/DESK, FRONT/CEILING, REAR/DESK, REAR/CEILING (Menu selection method)

*1. See "List of compatible signals" on page 47 for available signals.

Terminals	S-VIDEO IN	Single - line, Mini DIN 4p Y: 1.0 V [p-p], C: 0.286 V [p-p], 75 Ω
	VIDEO IN	Single - line, RCA pin jack 1.0 V [p-p], 75Ω
	COMPUTER IN	Single - line, D - sub HD 15-pin (female) Selectable for input and output by menu operation.
		R.G.B. 0.7 V [p-p], 75 Ω
		G.SYNC 1.0 V [p-p], 75 Ω
		HD/SYNC TTL high impedance, automatic positive/negative polarity compatible
VD TTL high impedance, automatic positive/negative polarity compatible		
COMPONENT IN	Y, PB/CB, PR/CR Single - line, RCA pin jack x 3 Y: 1.0 V [p-p] (including sync), 75 Ω PB/CB, (PR/CR) 0.7 V [p-p], 75 Ω	
HDMI IN	Triple - line, 19-pin HDMI connector	
SERIAL	D-sub 9-pin RS-232C compatible	
Cabinet	Moulded plastic (PC+ABS)	
Dimensions	Width	460 mm (18 -3/32")
	Height	130 mm (5 -3/32")
	Length	300 mm (11 -25/32")
Weight	7.2 kg (15.9 lbs.)	
Certifications	UL60950-1	C-UL
	FCC Class B	ICES-003
Remote control	Power supply	3 V DC (AA battery x 2)
	Operating range	Approx. 7 m (23') (when operated directly in front of signal receptor)
	Weight	170 g (6 ozs.) (including batteries)
	Dimensions	Width
Length		200 mm (7 -27/32")
Height		28.5 mm (1 -3/32") (not including surface projection parts)
Options	Cable cover	ET-PCE2000
	Ceiling bracket	ET-PKE2000/ET-PKE1000S
	Projection screen	ET-SRW90CC
	Cables	ET-SC10CP (RCA pin jack x 3 - RCA pin jack x3) ET-SC10DT (RCA pin jack x3 - D-Terminal)

Technical Information

Dimensions

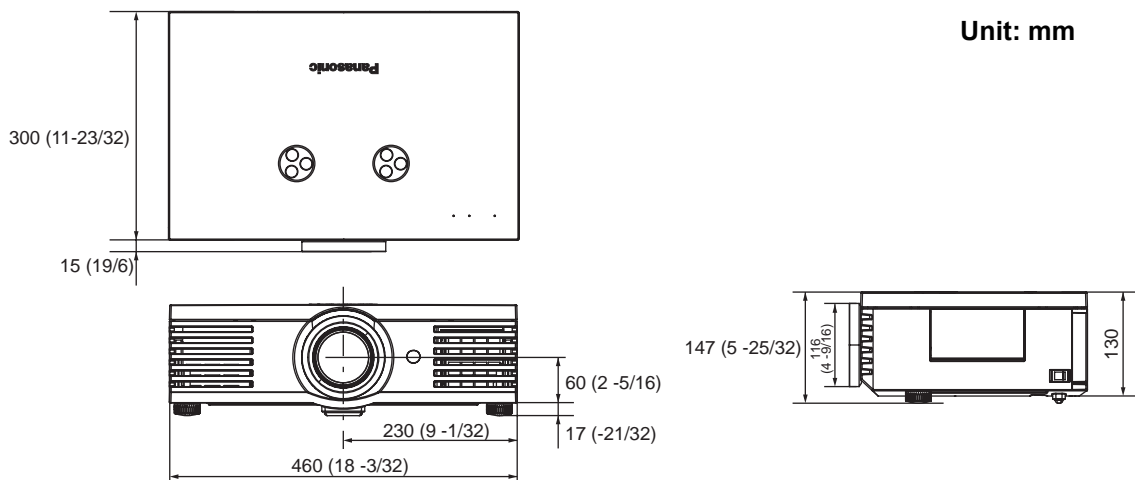

Trademark acknowledgements

- VGA and XGA are trademarks of International Business Machines Corporation.
- S-VGA is a registered trademark of the Video Electronics Standards Association.
- HDMI, the HDMI logo and High-Definition Multimedia Interface are trademarks or registered trademarks of HDMI Licensing LLC.
- The font used in the on-screen displays is a Ricoh bitmap font, which is manufactured and sold by Ricoh Company, Ltd.

All other trademarks are the property of the various trademark owners.

Index

A	AC IN 13	F	FOCUS
	Accessories 10		Control panel button 12
	ADVANCED MENU 33		LENS CONTROS menu 39
	Air exhaust port 12		FRAME RESPONSE 40
	Air filter 12		FREEZE
	Replacing 43		Remote control button 11
	Air intake port 13		Remote control function 22
	ALTITUDE 41		Front leg adjusters 13, 15
	ASPECT 36		FUNCTION BUTTON
	Remote control button 11		BUTTON1/2/3 39
	Remote control function 23		Main menu 39
	AUTO SEARCH 40		Remote control buttons 11
	AUTO SETUP 38		
B		G	
	BACK COLOR 40		GAMMA 33
	Batteries	H	
	Accessory 10		HDMI IN
	Compartment 11		Connection 18
	BLANK 39		Terminal 13
	BRIGHTNESS		HDMI SIGNAL LEVEL 40
	ADVANCED MENU 33		H-POSITION 36
	PICTURE menu 31	I	
C			INPUT
	Ceiling mount bracket 51		Control panel button 12
	CINEMA REALITY 34		Remote control button 11
	Cleaning 43		Remote control function 23
	CLOCK PHASE 36		INPUT GUIDE 40
	COLOR 31		INPUT SELECT
	COLOR M.		Control panel button 12
	Remote control button 11		INSTALLATION
	Remote control function 26		POSITION menu 41
	COLOR MANAGEMENT 34		Projection method 15
	Remote control button 11	K	
	Remote control function 26		KEYSTONE 38
	COLOR TEMPERATURE 32	L	
	COMPONENT IN		LAMP
	Connection 18		Indicator 12
	Terminal 13		Indicator status 42
	COMPUTER IN		LAMP POWER 41
	Connection 18		LAMP RUNTIME 41, 45
	Terminal 13		Lamp unit
	Connections 18		Replacing 44
	CONTRAST		LANGUAGE 29
	ADVANCED MENU 33		LENS
	PICTURE menu 31		Remote control button 11
D			Remote control function 25
	DEFAULT		LENS CONTROL
	Remote control button 11		Main menu 39
	Remote control function 22		Remote control button 11
	DETAIL CLARITY 34		Lens cover 12
	Dimensions 54		Accessory 10
	DOT CLOCK 36		Attachment hole 13
	DYNAMIC IRIS 32		Lens shift
E			Lens shift dial • Horizontal 12
	ENTER		Lens shift dial • Vertical 12
	Control panel button 12		LIGHT
	Remote control button 11		Remote control buttons 11
			Remote control function 22

M	MAIN POWER 12	S	Safety cable 51
	MEM.LOAD		Accessory 10
	Remote control button 11		Attachment point 13
	Remote control function 23		Screen size 14
	MEMORY EDIT 35		Calculation methods 14
	MEMORY LOAD 34		Security lock 13
	Remote control button 11		SERIAL
	Remote control function 23		Basic format 48
	MEMORY SAVE 34		Cable specifications 48
	MENU		Communication settings 49
	Control panel button 12		Connection 48
	Remote control button 11		Control commands 49
	Remote control function 30		Inquiry commands 50
	Menu		Pin assignments 48
	Main menu 28		Terminal 13
	Navigation 30		SHARPNESS 31
	Sub-menu 28		SLEEP 41
	MPEG NR 33		Remote control button 11
N			Remote control function 25
	Navigation buttons		Specifications 52
	Control panel button 12		SPLIT ADJUST 32
	Remote control button 11		STARTUP LOGO 40
	NR 33		S-VIDEO IN
O			Connection 18
	OPTION menu 40		Terminal 13
	OSD DESIGN 40	T	
	OSD POSITION 40		Technical Information 47
	OVER SCAN 38		TEMP
P			Indicator 12
	PIC.ADJUST		Indicator status 42
	Remote control button 11		Throw distance 14
	Remote control function 25		Throwing angle 15
	PIC.MODE		TINT 31
	Remote control button 11		Top cover 13, 44
	PICTURE 31		Troubleshooting 46
	Remote control button 11		TV-SYSTEM 34
	Remote control function 25	V	
	PICTURE MODE 31		VIDEO IN
	Remote control button 11		Connection 18
	Remote control function 25		Terminal 13
	POSITION 36		V-POSITION 36
	POWER	W	
	Control panel button 12		WAVEFORM
	Indicator 12		Remote control button 11
	Indicator status 19		Remote control function 24
	Remote control button 11		WAVEFORM MONITOR 32
	Power cord		WSS 38
	Accessory 10	X	
	Connecting 19		xvYCC 34
R		Z	
	Remote control 11		ZOOM
	Accessory 10		Control panel button 12
	Operating range 22		LENS CONTROL menu 39
	Operation 22		ZOOM/FOCUS 39
	Signal emitter 11		
	Signal receptor 12		
	RETURN		
	Control panel button 12		
	Remote control button 11		
	Remote control function 30		

NOTE:

This product contains a CR Coin Cell Lithium Battery which contains Perchlorate Material - special handling may apply.

See www.dtsc.ca.gov/hazardouswaste/perchlorate.

Panasonic[®]

Projectors

Panasonic Projector Systems Company

Unit of Panasonic Corporation of North America

One Panasonic Way, Secaucus, NJ 07094
(201) 392 - 6591

Technical Support:

(888) 411 - 1996

FAX: (201) 348 - 7523

E-Mail: projectorsupport@us.panasonic.com

Panasonic Canada Inc.

5770 Ambler Drive, Mississauga, Ontario L4W 2T3
(905) 624 - 5010

Panasonic Puerto Rico, Inc.

Ave. 65 de Infanteria, Km 9.5 San Gabriel Industrial Park, Carolina, Puerto Rico 00985
(787) 750 - 4300

<http://panasonic.net>

© 2007 Matsushita Electric Industrial Co., Ltd. All Rights Reserved.

Printed in Japan
S0807-1087B