



# **HT1100**

---

**Entertainment Projector**

**User's Manual**

**English**

**Deutsch**

**Français**

**Italiano**

**Español**

**Svenska**

# IMPORTANT INFORMATION

## Safety Cautions

### Precautions

Please read this manual carefully before using your NEC HT1100 Projector and keep the manual handy for future reference. Your serial number is located on the bottom of your projector. Record it here:



#### CAUTION

To turn off main power, be sure to remove the plug from power outlet.

The power outlet socket should be installed as near to the equipment as possible, and should be easily accessible.



#### CAUTION

TO PREVENT SHOCK, DO NOT OPEN THE CABINET. NO USER-SERVICEABLE PARTS INSIDE.

REFER SERVICING TO QUALIFIED NEC SERVICE PERSONNEL.



This symbol warns the user that uninsulated voltage within the unit may be sufficient to cause electrical shock. Therefore, it is dangerous to make any kind of contact with any part inside of the unit.



This symbol alerts the user that important information concerning the operation and maintenance of this unit has been provided.

The information should be read carefully to avoid problems.

#### WARNING

**TO PREVENT FIRE OR SHOCK, DO NOT EXPOSE THIS UNIT TO RAIN OR MOISTURE.**

**DO NOT USE THIS UNIT'S GROUNDED PLUG WITH AN EXTENSION CORD OR IN AN OUTLET UNLESS ALL THREE PRONGS CAN BE FULLY INSERTED.**

**DO NOT OPEN THE CABINET. THERE ARE HIGH-VOLTAGE COMPONENTS INSIDE. ALL SERVICING MUST BE DONE BY QUALIFIED NEC SERVICE PERSONNEL.**

### DOC Compliance Notice

This Class B digital apparatus meets all requirements of the Canadian Interference-Causing Equipment Regulations.

### Acoustic Noise Information Ordinance -3. GSGV:

The sound pressure level is less than 70 dB (A) according to ISO 3744 or ISO 7779.

#### WARNING TO CALIFORNIA RESIDENTS:

Handling the cables supplied with this product, will expose you to lead, a chemical known to the State of California to cause birth defects or other reproductive harm. Wash hands after handling.

## RF Interference

#### WARNING

The Federal Communications Commission does not allow any modifications or changes to the unit EXCEPT those specified by NEC Solutions (America), Inc. in this manual. Failure to comply with this government regulation could void your right to operate this equipment. This equipment has been tested and found to comply with the limits for a Class B digital device, pursuant to Part 15 of the FCC Rules. These limits are designed to provide reasonable protection against harmful interference in a residential installation. This equipment generates, uses, and can radiate radio frequency energy and, if not installed and used in accordance with the instructions, may cause harmful interference to radio communications. However, there is no guarantee that interference will not occur in a particular installation. If this equipment does cause harmful interference to radio or television reception, which can be determined by turning the equipment off and on, the user is encouraged to try to correct the interference by one or more of the following measures:

- Reorient or relocate the receiving antenna.
- Increase the separation between the equipment and receiver.
- Connect the equipment into an outlet on a circuit different from that to which the receiver is connected.
- Consult the dealer or an experienced radio / TV technician for help.

In UK, a BS approved power cable with moulded plug has a Black (five Amps) fuse installed for use with this equipment. If a power cable is not supplied with this equipment please contact your supplier.

### Important Safeguards

These safety instructions are to ensure the long life of your projector and to prevent fire and shock. Please read them carefully and heed all warnings.

### Installation

1. For best results, use your projector in a darkened room.
2. Place the projector on a flat, level surface in a dry area away from dust and moisture.
3. Do not place your projector in direct sunlight, near heaters or heat radiating appliances.
4. Exposure to direct sunlight, smoke or steam can harm internal components.
5. Handle your projector carefully. Dropping or jarring can damage internal components.
6. Do not place heavy objects on top of the projector.
7. If you wish to have the projector installed on the ceiling:
  - a. Do not attempt to install the projector yourself.
  - b. The projector must be installed by qualified technicians in order to ensure proper operation and reduce the risk of bodily injury.
  - c. In addition, the ceiling must be strong enough to support the projector and the installation must be in accordance with any local building codes.
  - d. Please consult your dealer for more information.

## Fire and Shock Precautions

1. Ensure that there is sufficient ventilation and that vents are unobstructed to prevent the build-up of heat inside your projector. Allow at least 4 inches (10 cm) of space between your projector and a wall.
2. Prevent foreign objects such as paper clips and bits of paper from falling into your projector.  
Do not attempt to retrieve any objects that might fall into your projector. Do not insert any metal objects such as a wire or screwdriver into your projector. If something should fall into your projector, disconnect it immediately and have the object removed by a qualified NEC service personnel.
3. Do not place any liquids on top of your projector.
4. Do not look into the lens while the projector is on. Serious damage to your eyes could result.
5. Keep any items such as magnifying glass out of the light path of the projector. The light being projected from the lens is extensive, therefore any kind of abnormal objects that can redirect light coming out of the lens, can cause unpredictable outcome such as fire or injury to the eyes.
6. Do not cover the lens with the supplied lens cap or equivalent while the projector is on. Doing so can lead to melting of the cap and possibly burning your hands due to the heat emitted from the light output.
7. The projector is designed to operate on a power supply of 100-120 or 200-240 V 50/60 Hz AC. Ensure that your power supply fits this requirement before attempting to use your projector.
8. Handle the power cable carefully and avoid excessive bending. A damaged cord can cause electric shock or fire.
9. If the projector is not to be used for an extended period of time, disconnect the plug from the power outlet.
10. Do not touch the power plug during a thunderstorm. Doing so can cause electrical shock or fire.

## CAUTION

1. Do not try to touch the ventilation outlet on the front and side as it can become heated while the projector is turned on.
2. Do not use the tilt-foot for purposes other than originally intended. Misuses such as gripping the tilt-foot or hanging on the wall can cause damage to the projector.
3. Do not send the soft carrying case by parcel delivery service or cargo shipment. The projector inside the soft carrying case could be damaged. (However, it is possible to use it as a carrycase on board.)
4. Select "High Speed" in the Fan mode if you continue to use the projector for consecutive days. (From the menu, select [Setup] → [Page 2] → [Fan Mode].)
5. Do not unplug the power cable from the wall outlet under any one of the following circumstances.  
Doing so can cause damage to the projector:
  - \* While the Hour Glass icon appears.
  - \* While the message "Please wait a moment." appears. This message will be displayed after the projector is turned off.
  - \* While the cooling fans are running. (The cooling fans continue to work for 90 seconds after the projector is turned off).
6. Do not eject the PC card while its data is being accessed. Doing so can damage your PC card data.
7. Do not hold the lens part with your fingers. Doing so could pinch fingers or hands causing injury.

## Lamp Replacement

- To replace the lamp, follow all instructions provided on page E-43.
- Be sure to replace the lamp when the message "The lamp has reached the end of its usable life. Please replace the lamp." appears. If you continue to use the lamp after the lamp has reached the end of its usable life, the lamp bulb may shatter, and pieces of glass may be scattered in the lamp case. Do not touch them as the pieces of glass may cause injury.

If this happens, contact your NEC dealer for lamp replacement.

- Allow a minimum of 90 seconds to elapse after turning off the projector. Then turn off the main power switch, disconnect the power cable and allow 60 minutes to cool the projector before replacing the lamp.

## What's in the Box?

Make sure your box contains everything listed. If any pieces are missing, contact your dealer.

Please save the original box and packing materials if you ever need to ship your HT1100 Projector.

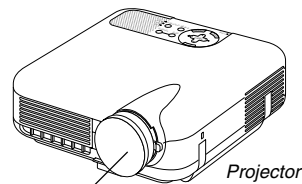

Projector

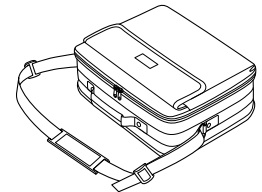

Soft carrying case  
(24BS7113)

Lens cap  
(24FT8661)



Remote control  
(7N900441)



Batteries



String and rivet  
(24C05051) (24C04531)

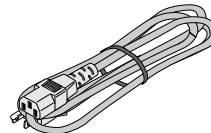

Power cable  
(7N080204: North America)  
(7N080003: G model)

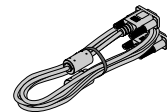

RGB signal cable  
(7N520012)

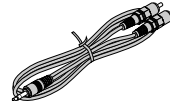

Audio cable  
(7N520027)

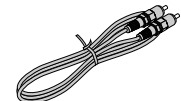

Composite video cable  
(7N520029)

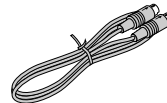

S-Video cable  
(7N520028)

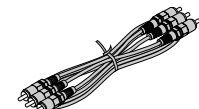

Component video cable  
(RCA × 3-to-RCA × 3)  
(7N520030)

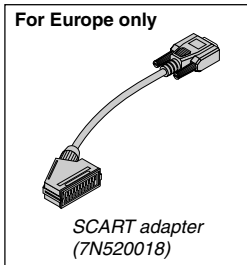

For Europe only

SCART adapter  
(7N520018)

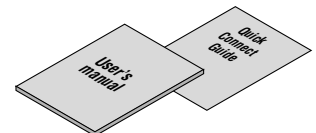

For North America only

Registration card  
Limited warranty

For Europe only  
Guarantee policy

# TABLE OF CONTENTS

<b>IMPORTANT INFORMATION</b> .....	<b>E-2</b>	Menu Descriptions & Functions .....	E-29
Safety Cautions .....	E-2	Picture .....	E-29
What's in the Box? .....	E-3	Preset, Reference, Brightness, Contrast, Color, Hue, Sharpness, Noise Reduction, Detail Settings .....	E-29
<b>INTRODUCTION</b> .....	<b>E-5</b>	Image [Page 1] .....	E-30
Introduction to the Projector .....	E-5	Aspect Ratio .....	E-30
Part Names of the Projector .....	E-6	Blanking, Position/Clock, Image Position, Overscan, Signal Type, Setup Level, Video Filter .....	E-32
Attaching the lens cap .....	E-6	Image [Page 2] .....	E-32
Top Features .....	E-7	Entry List .....	E-32
Terminal Panel Features .....	E-8	Setup [Page 1] .....	E-33
Part Names of the Remote Control .....	E-9	Screen, Orientation, Lamp Mode, Screen Trigger, Background, Language, Test Pattern .....	E-33
Battery Installation .....	E-10	Setup [Page 2] .....	E-33
Remote Control Precautions .....	E-10	Signal Select, Standby Mode, Fan Mode, Lamp Hour .....	E-33
Operating Range .....	E-10	Setting Auto Adjust .....	E-34
<b>INSTALLATION AND CONNECTIONS</b> .....	<b>E-11</b>	Setup [Page 3] .....	E-34
Setting Up the Screen and the Projector .....	E-11	Password (Logo), LAN Mode .....	E-34
Selecting a Location .....	E-11	Security .....	E-36
Throw Distance and Screen Size .....	E-12	Information .....	E-37
Making Connections .....	E-13	Returning to Factory Default [Reset] .....	E-37
Wiring Diagram .....	E-13	<b>USING THE VIEWER</b> .....	<b>E-38</b>
Connecting Your VCR or Laser Disc Player .....	E-14	Making the Most out of the Viewer Function .....	E-38
Connecting Your DVD Player .....	E-15	Operating the Viewer Function from the Projector (playback) ...	E-39
Connecting Your PC or Macintosh Computer .....	E-16	Changing Background Logo .....	E-42
To connect SCART output (RGB) .....	E-16	<b>MAINTENANCE</b> .....	<b>E-43</b>
When Viewing a DVI Digital Signal .....	E-17	Replacing the Lamp .....	E-43
Connecting the Supplied Power Cable .....	E-17	Cleaning .....	E-44
<b>PROJECTING AN IMAGE (BASIC OPERATION)</b> .....	<b>E-18</b>	Lens Protector .....	E-44
Turning on the Projector .....	E-18	<b>TROUBLESHOOTING</b> .....	<b>E-45</b>
Selecting a Source .....	E-19	<b>SPECIFICATIONS</b> .....	<b>E-47</b>
Adjusting the Picture Size and Position .....	E-19	<b>APPENDIX</b> .....	<b>E-48</b>
Correcting the Horizontal and Vertical Keystone Distortion (3D Reform) .....	E-20	Cabinet Dimensions .....	E-48
Optimizing RGB Picture Automatically .....	E-21	Pin Assignments of D-Sub COMPUTER Input Connector .....	E-48
Turning Up or Down Volume .....	E-22	Compatible Input Signal List .....	E-49
Turning off the Projector .....	E-22	PC Control Codes and Cable Connection .....	E-50
<b>CONVENIENT FEATURES</b> .....	<b>E-23</b>	Cable Connection .....	E-50
Using Image Position .....	E-23	PC Control Connector (DIN-8P) .....	E-50
Turning Off the Image and Sound .....	E-23	Using Software Keyboard .....	E-50
Freezing a Picture .....	E-23	Operation Using an HTTP Browser .....	E-51
Capturing a Picture .....	E-23	TravelCare Guide .....	E-52
Enlarging and Moving a Picture .....	E-24		
Getting the On-line Help .....	E-24		
<b>USING ON-SCREEN MENU</b> .....	<b>E-25</b>		
Using the Menus .....	E-25		
Menu tree .....	E-26		
Menu Elements .....	E-28		

# INTRODUCTION

## Introduction to the Projector

This section introduces you to your new HT1100 Projector and describes the features and controls.

## Congratulations on Your Purchase of The HT1100 Projector

The HT1100 is our most sophisticated single chip DLP™ based projector for the commercial and residential entertainment user. With the HT1100 you will enjoy projecting images up to 200" (measured diagonally) from your DVD player, VCR, satellite hookup, HDTV source, PC or Macintosh computer (desktop or notebook) and images from your digital camera. The HT1100 can be setup on a coffee table, tabletop, cart, bookshelf or permanently installed\*<sup>1</sup>. With an extensive input panel, quick connect guide and full function remote, you will be ready to immerse yourself in big screen enjoyment.

## Features you'll enjoy on the HT1100:

- Phenomenal 3500:1 contrast ratio with a variable IRIS that allows you to fine-tune the image contrast
- 3D Reform technology for positioning the projector in off center locations in the room and still get aligned images
- NEC designed and developed SweetVision™ technology for enhanced images, more vibrant colors and blacks richer with detail
- Deinterlace function eliminates jitter or artifacts in HDTV and Video signals
- Ability to display 16:9 and 4:3 aspect ratio sources
- HDTV, SDTV compatibility
- 3D 10-bit video decoder for expanded black levels and adaptive gamma correction
- Digital photo viewer to display larger than life images from your digital cameras PC or compact flash card
- Easy set up and operation
- High performance long life lamp for low total operating costs
- Eco-mode lamp technology for increased lamp life and energy savings
- Uncompromising display of video and data. Improves white level, color accuracy, dynamic range, and display of varying levels of black in an image.
- Sealed optics for reduced maintenance and better performance in dusty areas
- Wireless remote control operation
- Network capable with a wired card for the ability to maintain and control your projector from your computer
- Smart security settings for password protection and PC card protection key to help prevent unauthorized use
- Multiple video mode selections depending on your source.
- Control the unit with a PC using the PC Control port.
- NEC's exclusive Advanced AccuBlend intelligent pixel blending technology - an extremely accurate image compression technology - offers a crisp image with HDTV 1080p (1920×1080) resolution\*<sup>2</sup>.
- Supports most IBM VGA, SVGA, XGA, SXGA (with Advanced AccuBlend)\*<sup>2</sup>, Macintosh, component signal (YCbCr/YPbPr) or any other RGB signals within a horizontal frequency range of 24 to 100 kHz and a vertical frequency range of 48 to 100 Hz. This includes NTSC, PAL, PAL-N, PAL-M, PAL60, SECAM and NTSC4.43 standard video signals.

---

**NOTE:** Composite video standards are as follows:

*NTSC:* U.S. TV standard for video in U.S. and Canada.

*PAL:* TV standard used in Western Europe.

*PAL-N:* TV standard used in Argentine, Paraguay and Uruguay.

*PAL-M:* TV standard used in Brazil.

*PAL60:* TV standard used for NTSC playback on PAL TVs.

*SECAM:* TV standard used in France and Eastern Europe.

*NTSC4.43:* TV standard used in Middle East countries.

---

- You can control the projector with a PC using the PC Control port and wired LAN.
- The contemporary cabinet design is light, compact, easy to carry.

\*<sup>1</sup> Do not attempt to mount the projector on a ceiling yourself.

The projector must be installed by qualified technicians in order to ensure proper operation and reduce the risk of bodily injury.

In addition, the ceiling must be strong enough to support the projector and the installation must be in accordance with any local building codes. Please consult your dealer for more information.

\*<sup>2</sup> HDTV 1080p (1920×1080), HDTV 1080i (1920×1080) and HDTV 720p (1280×720) are displayed with NEC's Advanced AccuBlend.

Digital Light Processing and DLP are trademarks of Texas Instruments. The specifications are subject to change without notice.

All other trademarks are the property of their respective owners. All specifications subject to change without notice.

## Part Names of the Projector

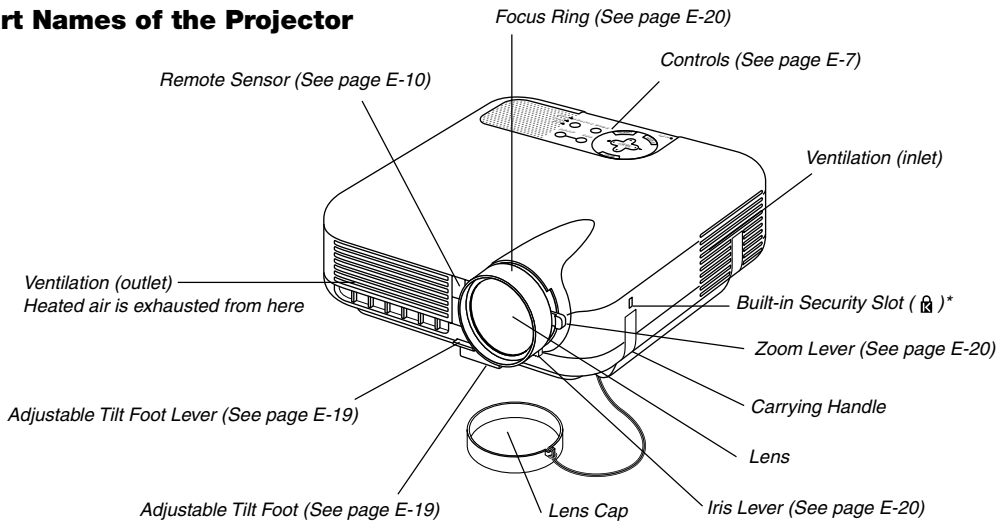

\* This security slot supports the MicroSaver® Security System. MicroSaver® is a registered trademark of Kensington Microware Inc. The logo is trademarked and owned by Kensington Microware Inc.

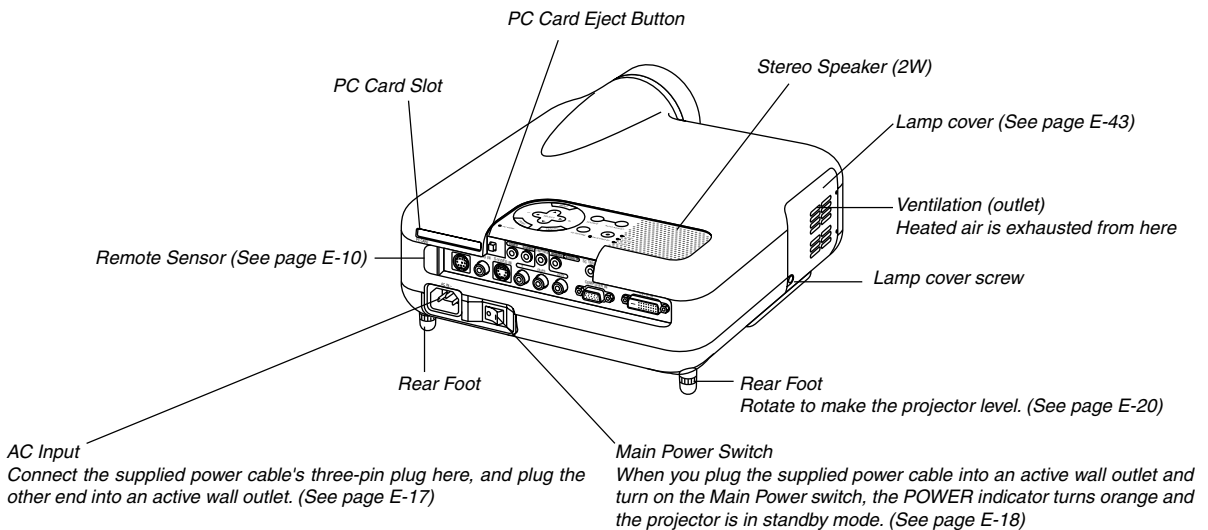

### Attaching the lens cap

To attach the lens cap to the bottom with the supplied string and rivet:

1. Thread the string through the hole on the lens cap and then tie a knot in the string.

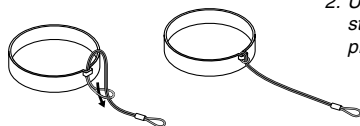

2. Use the rivet to attach the string to the bottom of the projector.

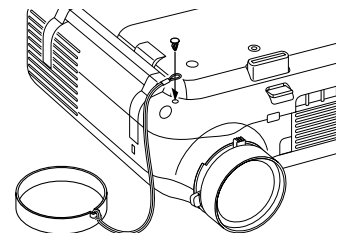

## Top Features

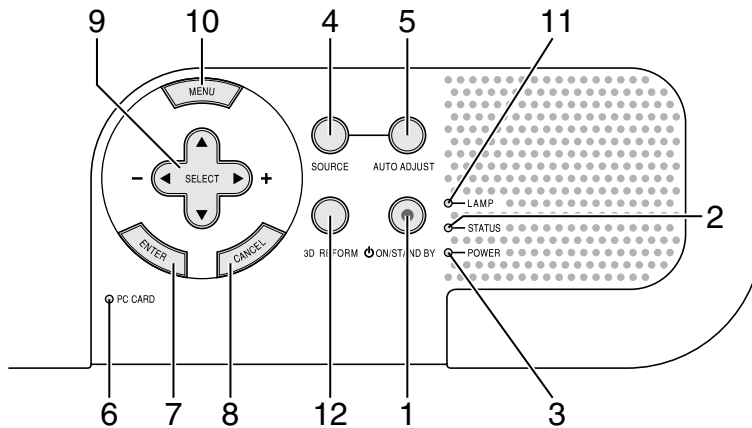

### 1. POWER Button (ON / STAND BY) (⏻)

Use this button to turn the power on and off when the main power is supplied and the projector is in standby mode (Power-saving mode or Idle mode).

**NOTE:** To turn on or off the projector, press and hold this button for a minimum of two seconds.

### 2. STATUS Indicator

If this light blinks red rapidly, it indicates that an error has occurred, the lamp cover is not attached properly or the projector has overheated. See the Status Indicator section on page E-45 for more details.

### 3. POWER Indicator

When this indicator is green, the projector is on; when this indicator is orange, it is in standby mode (Power-saving mode or Idle mode). See the Power Indicator section on page E-45 for more details.

### 4. SOURCE Button

Use this button to select a video source such as a VCR, DVD player, PC or Viewer (PC card). Press and release this button quickly to display the Source List.

Each time this button is pressed for a minimum of ONE second the input source will change as follows:

Video → S-Video → Component → Computer → DVI (DIGITAL) → Viewer → Video → ...

If no input signal is present, the input will be skipped.

### 5. AUTO ADJUST Button

Use this button to adjust Position-H/V and Pixel Clock/Phase for an optimal picture. Some signals may not be displayed correctly or take time to switch between sources.

**NOTE:** This function may not be available depending upon the input signal.

### 6. PC CARD Access Indicator

Lights while accessing a PC card.

### 7. ENTER Button

Executes your menu selection and activates items selected from the menu.

### 8. CANCEL Button

Press this button to exit "Menus". Press this button to return the adjustments to the last condition while you are in the adjustment or setting menu.

### 9. SELECT ▲▼◀▶ (+) (-) / Volume Buttons

▲▼ : Use these buttons to select the menu of the item you wish to adjust.

◀▶ : Use these buttons to change the level of a selected menu item. When no menus appear, these buttons work as a volume control, these buttons can be used to select a slide.

**NOTE:** When the Viewer is selected, volume control is not available.

### 10. MENU Button

Displays the menu.

### 11. LAMP Indicator

If this light blinks red rapidly, it's warning you that the projection lamp has exceeded 2000 hours (up to 3000 hours in Eco mode) of service. After this light appears, replace the lamp as soon as possible. (See page E-43). If this is lit green continually, it indicates that the lamp mode is set to Eco. See the Lamp Indicator section on page E-45 for more details.

### 12. 3D REFORM Button

Press this button to enter 3D Reform mode to correct the keystone (trapezoidal) distortion, and make the image square. This button toggles between "Keystone" and "Cornerstone".

## Terminal Panel Features

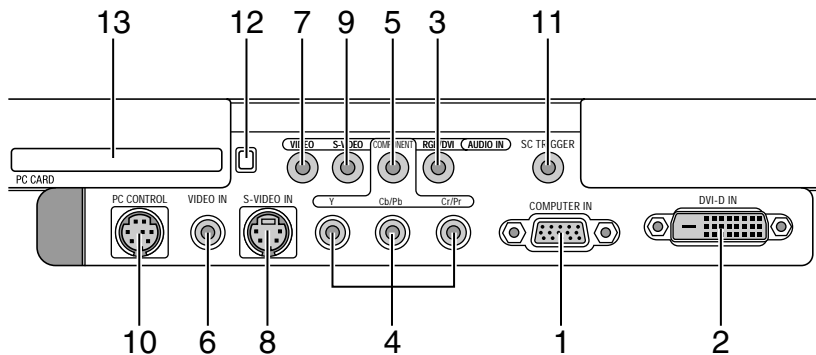

1. **COMPUTER IN / Component Input Connector (Mini D-Sub 15 Pin)**  
Connect your computer or other analog RGB equipment such as IBM compatible or Macintosh computers. Use the supplied RGB cable to connect to your computer. This also serves as a component input connector that allows you to connect a component video output of component equipment such as a DVD player (optional adapter ADP-CV1 required). This connector also supports SCART output signal. See page E-16 for more details.
2. **DVI-D IN (DVI 24 Pin)**  
This connector can be used to accept digital signal output from a computer or a set top box with a DVI connector. (HDCP compatible)
3. **RGB/DVI AUDIO IN Mini Jack (Stereo Mini)**  
This is where you connect audio output from your computer connected to RGB IN or DVI-D IN.
4. **COMPONENT (Y, Cb/Pb, Cr/Pr) input Connectors (RCA)**  
Connect component video outputs (Y/Cb/Cr, Y/Pb/Pr) of the external equipment such as DVD player.  
**NOTE:** These connectors accept component signal only.
5. **COMPONENT AUDIO IN Mini Jack (Stereo Mini)**  
This is where you connect audio output from your DVD player or component equipment connected to COMPONENT IN.
6. **VIDEO IN (RCA)**  
Connect a VCR, DVD player or laser disc player here to project video.
7. **VIDEO AUDIO IN Mini Jack (Stereo Mini)**  
This is where you connect audio output from your VCR, DVD player or laser disc player connected to VIDEO IN.
8. **S-VIDEO IN (Mini DIN 4 Pin)**  
Connect a VCR, DVD player or laser disc player with S-Video output.  
**NOTE:** S-Video provides more vivid color and higher resolution than the traditional composite video format.
9. **S-VIDEO AUDIO IN Mini Jack (Stereo Mini)**  
This is where you connect audio output from your VCR, DVD player or laser disc player connected to S-VIDEO IN.

10. **PC CONTROL Port (Mini DIN 8 Pin)**  
Use this port to connect your PC to control your projector via a serial cable. This enables you to use your PC and serial communication protocol to control the projector. The NEC optional serial cable (CA03D) is required to use this port. If you are writing your own program, typical PC control codes are on page E-50. A cap is put on the port at the factory. Remove the cap when using the port.

11. **SC TRIGGER Mini Jack**  
When the projector is powered ON the screen trigger output sends a high voltage trigger to the screen controller and the screen will go down.  
When the projector is powered OFF the screen trigger stops sending a low voltage trigger to the screen controller and the screen will go up.  
**NOTE:** To enable the SC.TRIGGER function, be sure to turn on "Screen Trigger" in "Page 1" of the Setup. See page E-33.

**NOTE:** Screen Controllers are supplied and supported by screen manufacturers. This option is not included with the projector.

**NOTE:** Do not use this jack for anything other than intended use. Connecting an audio cable or equivalent to the SC. TRIGGER Mini Jack causes damage to this mini jack.

Stereo mini cable  
(not supplied)

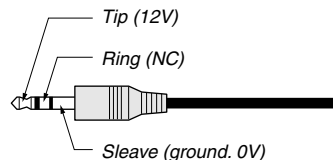

12. **PC CARD Eject Button**  
Press to eject a PC card partially.
13. **PC CARD Slot**  
Insert a PC card or commercially available wired LAN card here.



## Part Names of the Remote Control

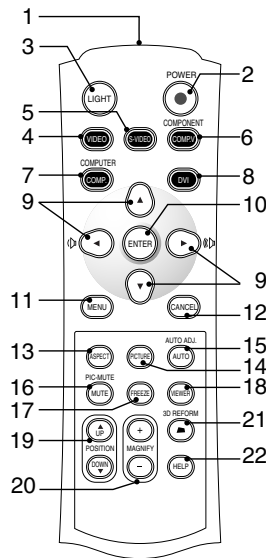

1. **Infrared Transmitter**  
Direct the remote control toward the remote sensor on the projector cabinet.
2. **POWER Button**  
Use this button to turn the power on and off when the main power is supplied and the projector is in standby mode (Power-saving mode or Idle mode).  
To turn on or off the projector, press and hold this button for a minimum of two seconds.
3. **LIGHT Button**  
Use this button to turn on or off the button's backlight. Unless another button is pressed within 10 seconds while the backlight is on, it will turn off to conserve the batteries.
4. **VIDEO Button**  
Press this button to select an NTSC, PAL, PAL-N, PAL-M, PAL60, SECAM or NTSC4.43 compatible video source from a VCR, DVD player, or laser disc player.
5. **S-VIDEO Button**  
Press this button to select an S-Video source from a VCR, DVD player or laser disc player.
6. **COMPONENT Button**  
Press this button to select a video source from component equipment connected to your COMPONENT input.
7. **COMPUTER Button**  
Press this button to select a video source from computer or component equipment connected to your COMPUTER IN port.
8. **DVI Button**  
Press this button to select a DVI digital signal from a computer, DVD player or settop box.
9. **Select ▲▼◀▶ / Volume Button**  
▲▼ : Use these buttons to select the menu of the item you wish to adjust.  
◀▶ : Use these buttons to change the level of a selected menu item. When no menus appear, these buttons work as a volume control.  
**NOTE:** *When the Viewer is selected, volume control is not available.*
10. **ENTER Button**  
Executes your menu selection and activates items selected from the menu.
11. **MENU Button**  
Displays the menu for various settings and adjustments.
12. **CANCEL Button**  
Press this button to exit "Menus". Press this button to return the adjustments to the last condition while you are in the adjustment or setting menu.
13. **ASPECT Button**  
Press this button to display the Aspect Ratio select screen. Each time this button is pressed, the option will be changed. See page E-30.
14. **PICTURE Button**  
Press this button to display the Preset window. Each time this button is pressed, the option will be changed. See page E-29.
15. **AUTO ADJ Button**  
Use this button to adjust an COMPUTER source for an optimal picture. Some signals may not be displayed correctly or take time to be displayed. See page E-21.  
**NOTE:** *This function may not be available depending upon the input signal.*
16. **PIC-MUTE Button**  
This button turns off the image and sound for a short period of time. Press again to restore the image and sound.  
**NOTE:** *When the menu is displayed, a press of this button mutes an image and sound without turning off the menu.*
17. **FREEZE Button**  
This button will freeze a picture. Press again to resume motion.
18. **VIEWER Button**  
Press this button to select the Viewer source.
19. **POSITION Up/Down Button**  
This button adjusts position of a zoomed image. See page E-23.
20. **MAGNIFY (+) (-) Button**  
Use this button to adjust the image size up to 400%. The image is magnified about the center of the screen. When the image is magnified, you can move the image by using the SELECT ▲▼◀▶ button. See page E-24.
21. **3D REFORM Button**  
Press this button to enter 3D Reform to correct the keystone (trapezoidal) distortion, and make the image square. See page E-20.
22. **HELP Button**  
Provides the online help or the set information.

## Battery Installation

1. Press firmly and slide the battery cover off.

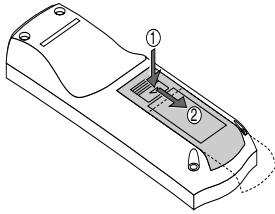

2. Remove both old batteries and install new ones (AAA). Ensure that you have the batteries' polarity (+/-) aligned correctly.

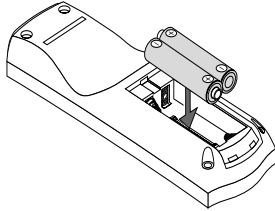

3. Slip the cover back over the batteries until it snaps into place. Do not mix different types of batteries or new and old batteries.

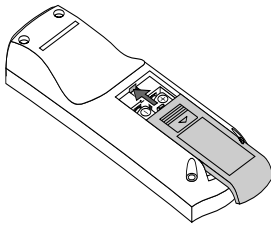

## Remote Control Precautions

- Handle the remote control carefully.
- If the remote control gets wet, wipe it dry immediately.
- Avoid excessive heat and humidity.
- If you will not be using the remote control for a long time, remove the batteries.
- Do not place the batteries upside down.
- Do not use new and old batteries together, or use different types of batteries together.

## Operating Range

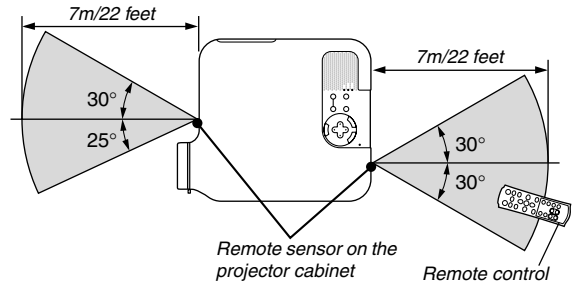

- The infrared signal operates by line-of-sight up to a distance of about 22 feet / 7 m and within a 55°(Front) / 60°(Rear) angle of the remote sensor on the projector cabinet.
- The projector will not respond if there are objects between the remote control and the sensor, or if strong light falls on the sensor. Weak batteries will also prevent the remote control from properly operating the projector.

# INSTALLATION AND CONNECTIONS

This section describes how to set up your projector and how to connect video and audio sources.

Your projector is simple to set up and use. But before you get started, you must first:

- 1 Set up a screen and the projector.
- 2 Connect your video equipment to the projector. See page E-13 – 17.
- 3 Connect the supplied power cable. See page E-17.

**NOTE:** Ensure that the power cable and any other cables are disconnected before moving the projector. When moving the projector or when it is not in use, cover the lens with the lens cap.

## Setting Up the Screen and the Projector

### Selecting a Location

The further your projector is from the screen or wall, the larger the image. The minimum size the image can be is approximately 30" (0.8 m) measured diagonally when the projector is roughly 4 feet (1.0 m) from the wall or screen. The largest the image can be is 200" (5.08 m) when the projector is about 23 feet (7 m) from the wall or screen. Use the drawing below as a guide.

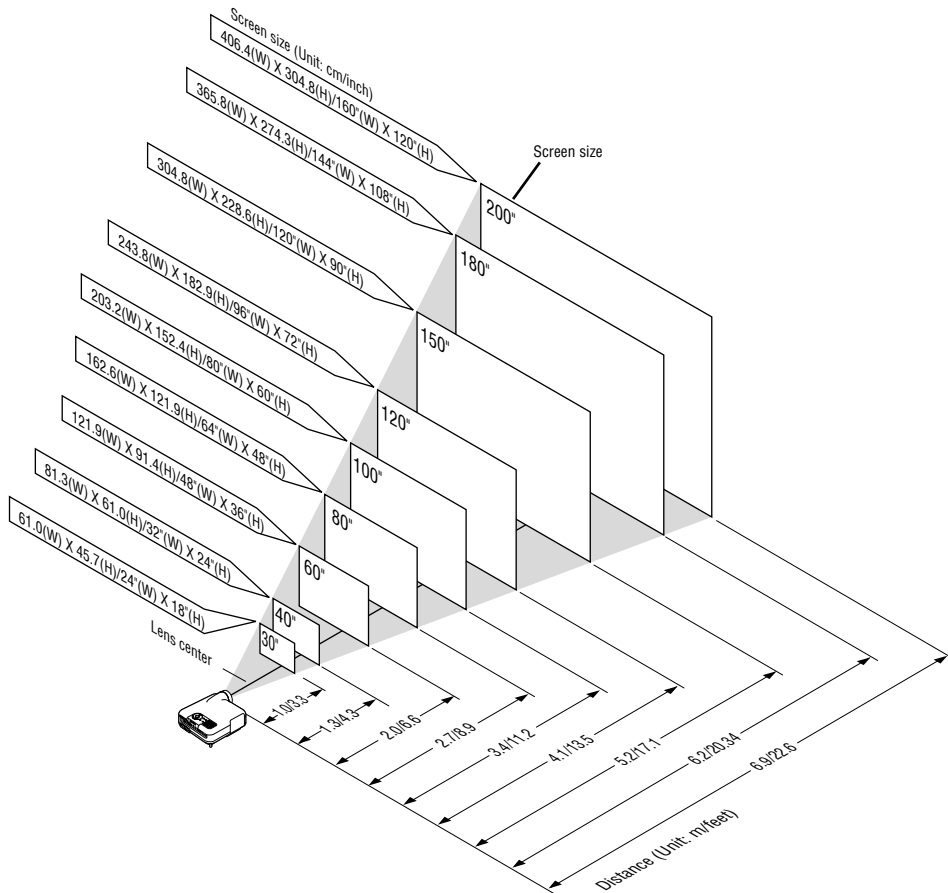

**NOTE:** The above shows the throw distance for 4:3 screen.

## Throw Distance and Screen Size

The following shows the proper relative positions of the projector and screen. Refer to the table to determine the position of installation.

### Distance Chart

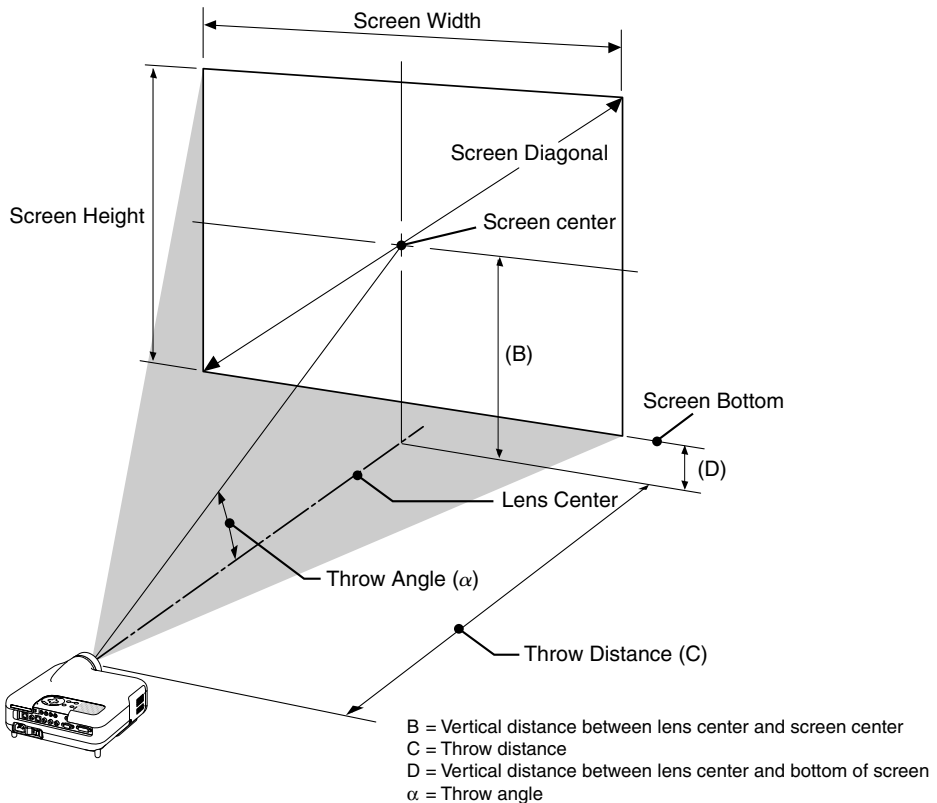

**NOTE:** Distances may vary +/-5%.

### 4:3

Screen Size			B	C		D	$\alpha$	
Diagonal	Width	Height		Wide - Tele	Wide - Tele		inch	degree
30	24	18	12.6	35.7 - 43.4	3.6	19.3 - 16.1		
40	32	24	16.8	48.2 - 58.4	4.8	19.1 - 16.0		
50	40	30	21.0	60.7 - 73.5	6.0	19.0 - 15.9		
60	48	36	25.2	73.2 - 88.5	7.2	18.9 - 15.8		
80	64	48	33.6	98.1 - 118.6	9.6	18.9 - 15.8		
100	80	60	42.0	123.1 - 148.6	12.0	18.8 - 15.7		
120	96	72	50.4	148.1 - 178.7	14.4	18.8 - 15.7		
150	120	90	63.0	185.5 - 223.8	18.0	18.7 - 15.7		
180	144	108	75.6	223.0 - 268.9	21.6	18.7 - 15.7		
200	160	120	84.0	248.0 - 298.9	24.0	18.7 - 15.7		

Screen Size			B	C		D	$\alpha$	
Diagonal	Width	Height		Wide - Tele	Wide - Tele		mm	degree
762.0	609.6	457.2	319.8	907 - 1102	91.2	19.3 - 16.1		
1016.0	812.8	609.6	426.5	1224 - 1484	121.7	19.1 - 16.0		
1270.0	1016.0	762.0	533.3	1541 - 1866	152.3	19.0 - 15.9		
1524.0	1219.2	914.4	640.0	1858 - 2248	182.8	18.9 - 15.8		
2032.0	1625.6	1219.2	853.4	2493 - 3011	243.8	18.9 - 15.8		
2540.0	2032.0	1524.0	1066.9	3127 - 3775	304.9	18.8 - 15.7		
3048.0	2438.4	1828.8	1280.4	3761 - 4539	366.0	18.8 - 15.7		
3810.0	3048.0	2286.0	1600.6	4713 - 5684	457.6	18.7 - 15.7		
4572.0	3657.6	2743.2	1920.8	5664 - 6829	549.2	18.7 - 15.7		
5080.0	4064.0	3048.0	2134.3	6298 - 7593	610.3	18.7 - 15.7		

**NOTE:** A 16:9 image is supported within the limits of the above values.

### WARNING

- \* **Installing your projector on the ceiling must be done by a qualified technician. Contact your NEC dealer for more information.**
- \* **Do not attempt to install the projector yourself.**
- Only use your projector on a solid, level surface. If the projector falls to the ground, you can be injured and the projector severely damaged.
- Do not use the projector where temperatures vary greatly. The projector must be used at temperatures between 41°F (5°C) and 95°F (35°C).
- Do not expose the projector to moisture, dust, or smoke. This will harm the screen image.
- Ensure that you have adequate ventilation around your projector so heat can dissipate. Do not cover the vents on the side or the front of the projector.

### Reflecting the Image

Using a mirror to reflect your projector's image enables you to enjoy a much larger image. Contact your NEC dealer if you need a mirror. If you're using a mirror and your image is inverted, use the MENU and SELECT buttons on your projector cabinet or ▲▼ buttons on your remote control to correct the orientation. (See page E-33.)

# Making Connections

## Wiring Diagram

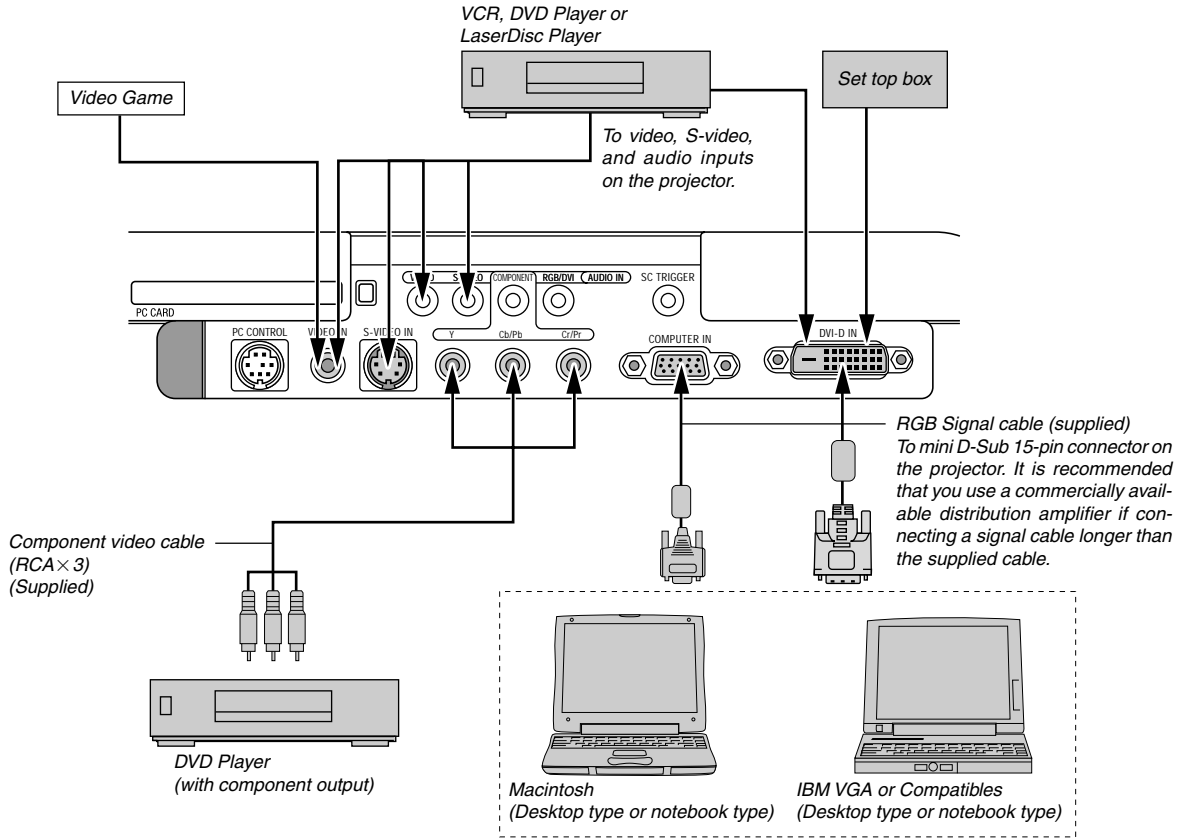

**NOTE:** When using with a notebook PC, be sure to connect between the projector and the notebook PC before turning on the power to the notebook PC. In most cases signal cannot be output from RGB output unless the notebook PC is turned on after connecting with the projector.

\* If the screen goes blank while using your remote control, it may be the result of the computer's screen-saver or power management software.

\* If you accidentally hit the POWER button on the remote control, wait 90 seconds and then press the POWER button again to resume.

## Connecting Your VCR or Laser Disc Player

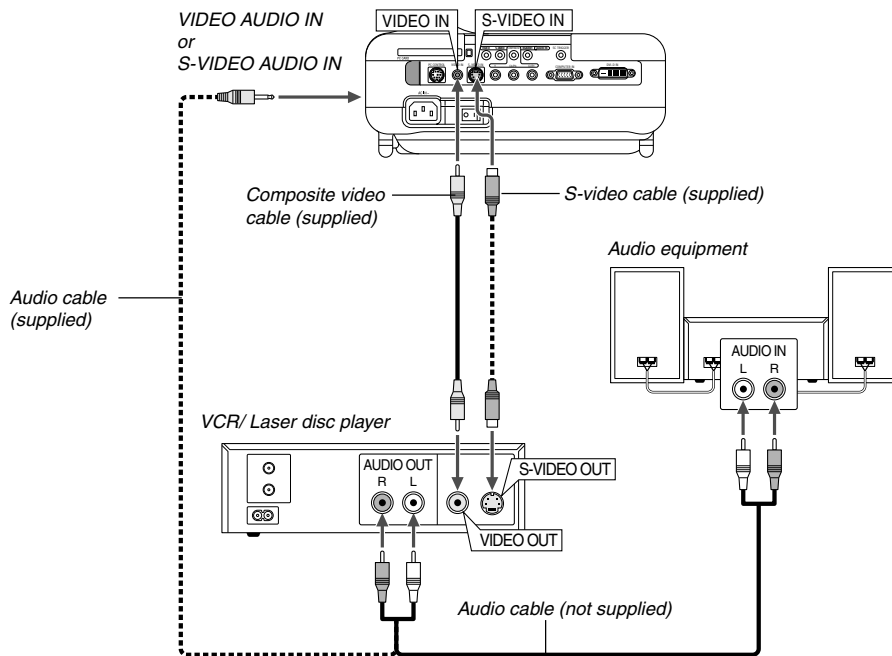

Use the supplied composite video cable to connect your VCR or laser disc player to your projector. To make these connections, simply:

1. Turn off the power to the projector and VCR or laser disc player.
2. Connect one end of the composite video cable to the video output connector on the back of your VCR or laser disc player, connect the other end to the Video input on your projector. Use an audio cable (not supplied) to connect the audio from your VCR or laser disc player to your audio equipment (if your VCR or laser disc player has this capability). Be careful to keep your right and left channel connections correct for stereo sound.
3. Turn on the projector and the VCR or laser disc player.

---

**NOTE:** Refer to your VCR or laser disc player owner's manual for more information about your equipment's video output requirements.

## Connecting Your DVD Player

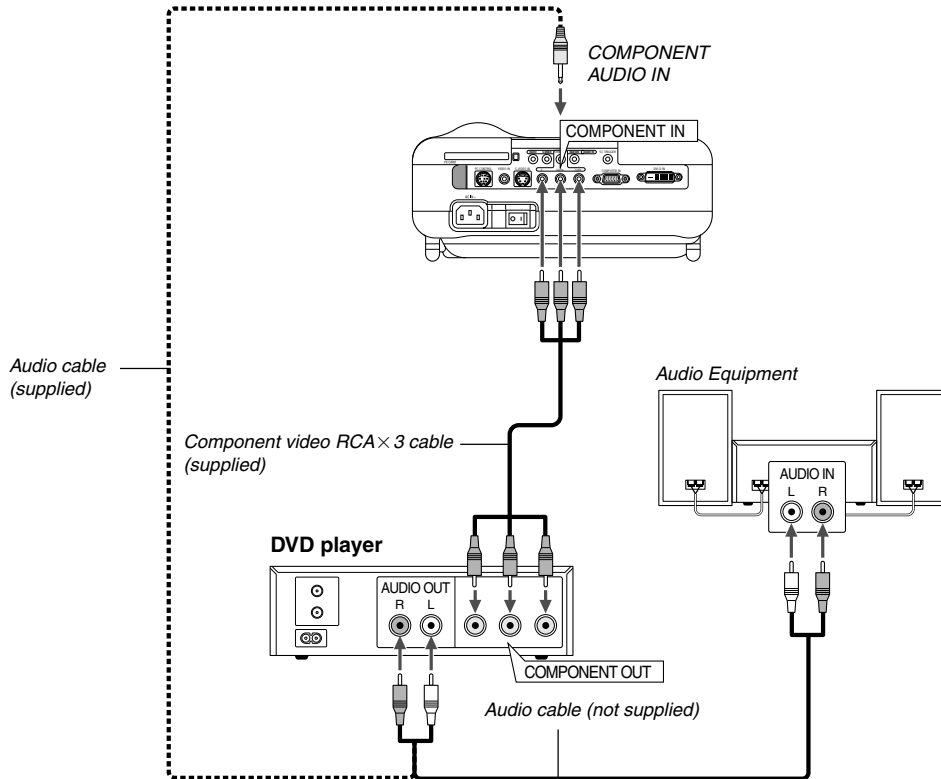

You can connect your projector to a DVD player with component output or Video output. To do so, simply:

1. Turn off the power to your projector and DVD player.
2. If your DVD player has the component video (Y,Cb,Cr) output, use the supplied component video cable (RCA x 3) to connect your DVD player to the COMPONENT IN connectors on the projector.  
For a DVD player without component video (Y,Cb,Cr) output, use common RCA cables (not provided) to connect a composite VIDEO output of the DVD player to the Video Input of the projector.  
Use an audio cable (not supplied) to connect the audio from your VCR or laser disc player to your audio equipment (if your VCR or laser disc player has this capability). Be careful to keep your right and left channel connections correct for stereo sound.
3. Turn on the projector and DVD player.

**NOTE:** Refer to your DVD player's owner's manual for more information about your DVD player's video output requirements.

## Connecting Your PC or Macintosh Computer

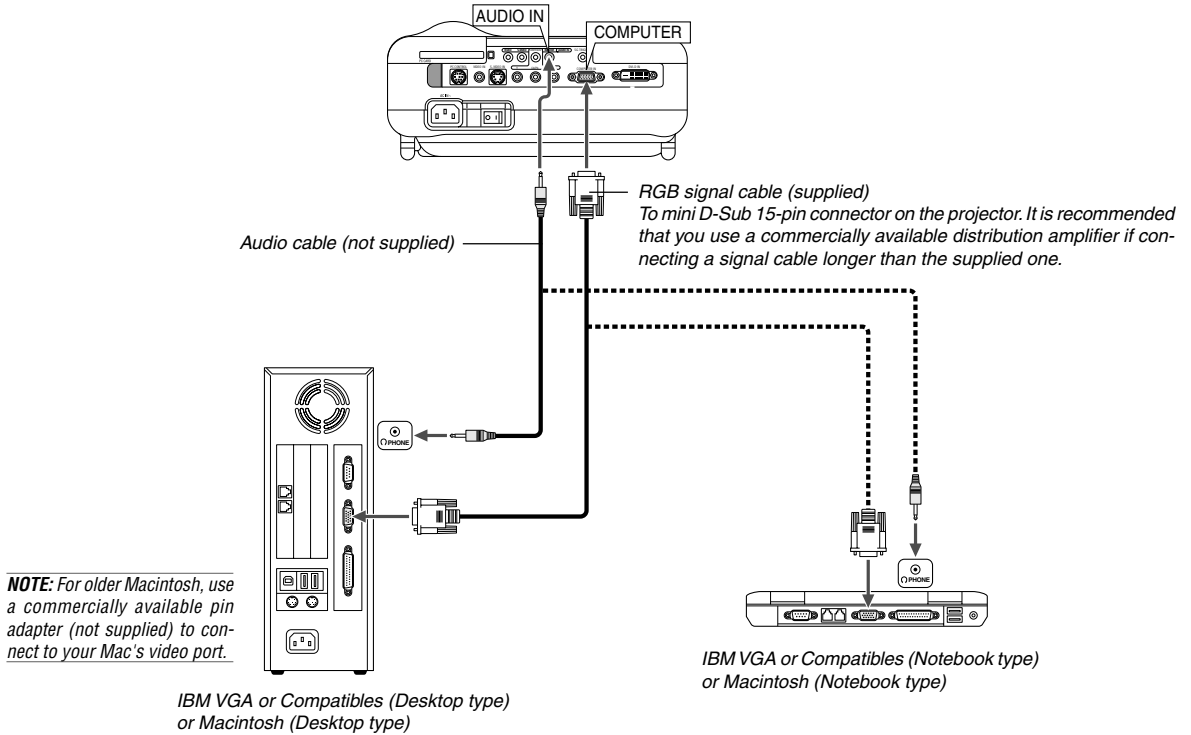

Connecting your PC or Macintosh computer to your projector will enable you to project your computer's screen image for an impressive presentation.

To connect to a PC or Macintosh, simply:

1. Turn off the power to your projector and computer.
2. Use the supplied signal cable to connect your PC or Macintosh to the projector.
3. Turn on the projector and the computer.
4. If the projector goes blank after a period of inactivity, it may be caused by a screen saver installed on the computer you've connected to the projector.

**NOTE:** The HT1100 is not compatible with video decoded outputs of NEC ISS-6020 and ISS-6010.

**NOTE:** An image may not be displayed correctly when a Video or S-Video source is played back via a commercially available scan converter. This is because the projector will process a video signal as a computer signal at the default setting. In that case, do the following.

- \* When noise appears on the sides of the screen:  
Use the Overscan feature to display the image correctly.  
Be sure to change the Overscan to 0% before pressing the AUTO ADJ or AUTO ADJUST button. Unless otherwise an image may be displayed with its sides cut off.

## For European model only

### To connect SCART output (RGB)

Before connections: The supplied SCART adapter (ADP-SC1) and a commercially available SCART cable are required for this connection.

**NOTE:** Audio signal is not available for this connection.

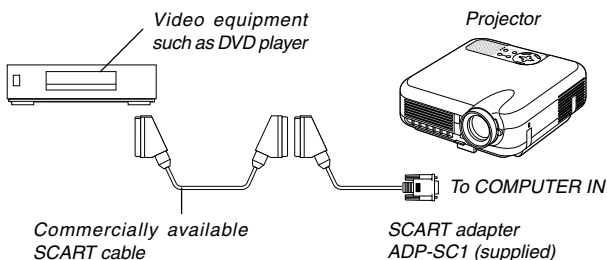

1. Turn off the power to the projector and your video equipment.
2. Use the supplied SCART adapter and a commercially available SCART cable to connect the COMPUTER input of your projector and a SCART output (COMPUTER) of your video equipment.
3. Turn on the power to the projector and your video equipment.
4. Use the COMPUTER button on the remote control to select the COMPUTER input.
5. Press the MENU button on the remote control to display the menu.
6. From the Advanced menu, select [Setup] → [Page 2] → [Signal Select] → [Computer] → [Scart].  
SCART is a standard European audio-visual connector for TVs, VCRs and DVD players. It is also referred to as Euro-connector.



## When Viewing a DVI Digital Signal:

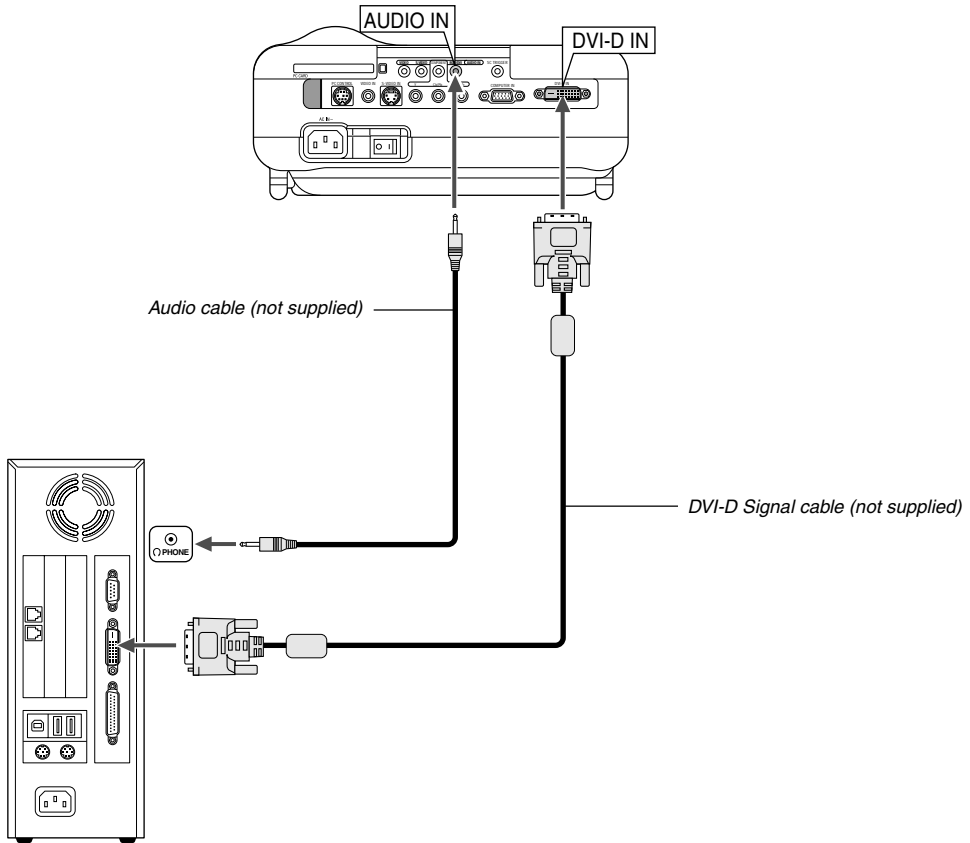

To project a DVI digital signal, be sure to connect the PC and the projector using a DVI-D signal cable (not supplied) before turning on your PC or projector. Turn on the projector first and select DVI (DIGITAL) from the source menu before turning on your PC.

Failure to do so may not activate the digital output of the graphics card resulting in no picture being displayed. Should this happen, restart your PC. Do not disconnect the DVI-D signal cable while the projector is running. If the signal cable has been disconnected and then re-connected, an image may not be correctly displayed. Should this happen, restart your PC.

### NOTE:

- Use the DVI-D cable compliant with DDWG (Digital Display Working Group) DVI (Digital Visual Interface) revision 1.0 standard. The DVI-D cable should be within 5 m (196") long.
- See page E-49 for DVI digital signals the DVI (DIGITAL) connector supports.

## Connecting the Supplied Power Cable

Connect the supplied power cable to the projector. First connect the supplied power cable's three-pin plug to the AC IN of the projector, and then connect the other plug of the supplied power cable in the wall outlet.

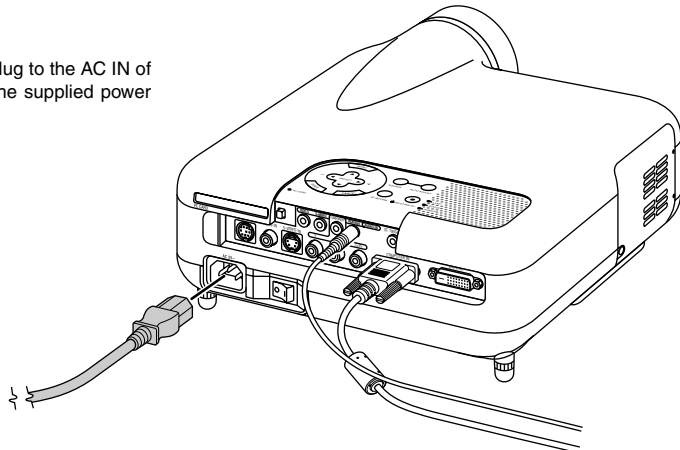

# PROJECTING AN IMAGE (BASIC OPERATION)

This section describes how to turn on the projector and to project a picture onto the screen.

2. Press the ENTER button to execute the selection.

## Turning on the Projector

### NOTE:

- When plugging in or unplugging the supplied power cable, make sure that the main power switch is pushed to the off (O) position. Failure to do so may cause damage to the projector.
- The projector has two power switches: main power switch and POWER button.
- The projector has a feature to prevent itself from being used by unauthorized individuals. To use this feature, register your PC card as a protect key. See "Security" on page E-36 for more details.

To turn on the main power to the projector, press the Main Power switch to the ON position (I).

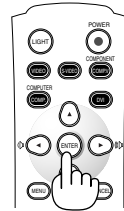
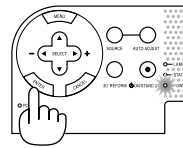
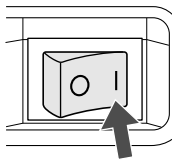

3. The menu will be displayed in the language you have selected.

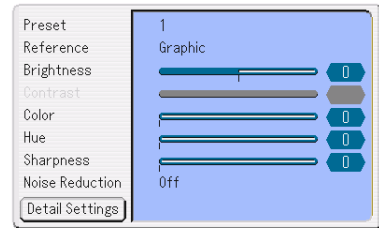

Before you turn on your projector, ensure that the computer or video source is turned on and that your lens cap is removed. Only after you press the POWER (ON/STAND BY) button on the projector cabinet or POWER button on the remote control for a minimum of 2 seconds will the power indicator turn to green and the projector become ready to use.

To close the menu, press the CANCEL button.

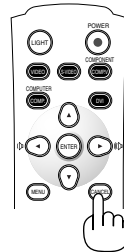
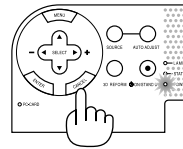
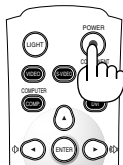
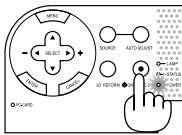

### Note on Startup screen (Menu Language Select screen)

When you first turn on the projector, you will get the Startup screen. This screen gives you the opportunity to select one of the 18 menu languages.

After this has been done, you can proceed to the menu operation. If you want, you can select the menu language later. See "Language" on page E-33.

1. Use the SELECT ▲ or ▼ button to select one of the 18 languages for the menu.

When the Lamp mode is set to Eco, the Lamp indicator will light green. If one of the following things happens, the projector will not turn on.

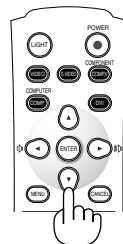
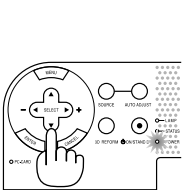

- \* If the internal temperature of the projector is too high, the projector detects abnormal high temperature. In this condition the projector will not turn on to protect the internal system. If this happens, wait for the projector's internal components to cool down.
- \* When the lamp reaches its end of usable life, the projector will not turn on. If this happens, replace the lamp.
- \* If the lamp fails to light, and if the STATUS indicator flashes on and off in a cycle of six times, wait a full minute and then turn on the power.

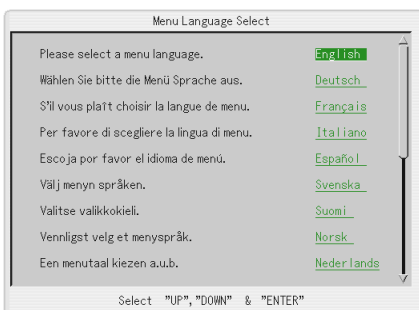

## Selecting a Source

### Selecting the computer or video source

Using the Remote Control



Press any one of the VIDEO, S-VIDEO, COMPONENT, COMPUTER, DVI or VIEWER buttons.

**NOTE:** If no input signal is available, the projector will display a blue background (factory preset).

Selecting from Source List

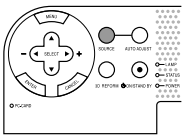

#### Source List

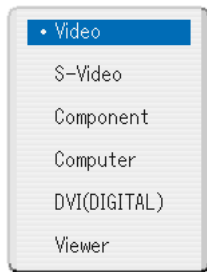

Press and quickly release the SOURCE button on the projector cabinet to display the Source list. Each time the SOURCE button is pressed, the input source will change as follows: "Video" (VCR, or laser disc player), "S-Video", "Component" (DVD player), "Computer" or "DVI(DIGITAL)" (computer) or "Viewer" (slides on a PC card). To display the selected source, press the ENTER button.

Detecting the Signal Automatically

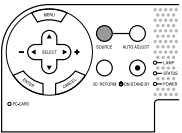

Press and hold the SOURCE button for a minimum of 1 second, the projector will search for the next available input source. Each time you press and hold the SOURCE button, the input source will change as follows:

→ Video → S-Video → Component → Computer → DVI(DIGITAL) → Viewer

If no input signal is present, the input will be skipped. When the input source you wish to project is displayed, release the button.

## Adjusting the Picture Size and Position

Place your projector on a flat level surface and ensure that the projector is square to the screen.

Lift the front edge of the projector to center the image vertically.

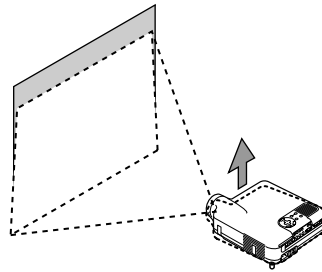

Move the projector left to center the image horizontally on the screen.

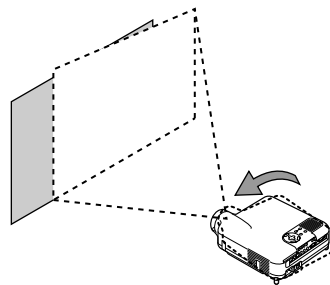

\* If the projected image does not appear square to the screen then use the 3D Reform feature for proper adjustment. See page E-20.

### Adjust the Tilt Foot

1. Lift the front edge of the projector.

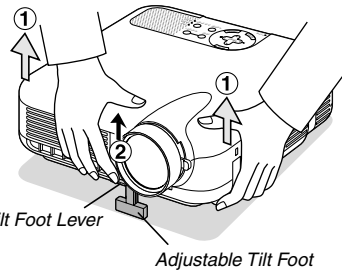

Adjustable Tilt Foot Lever

Adjustable Tilt Foot

2. Push up the Adjustable Tilt Foot Lever on the front of the projector to extend the adjustable tilt foot (maximum height).

3. Push down the Adjustable Tilt Foot Lever.

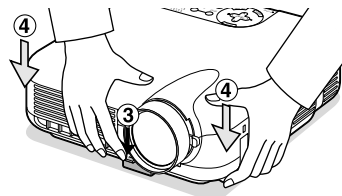

4. Lower the front of the projector to the desired height and release the Adjustable Tilt Foot Lever to lock the Adjustable tilt foot. There is approximately 7 degrees of up and down adjustment for the front of the projector.

### Adjusting Screen Position

See "Selecting Aspect Ratio and Position for Screen" on page E-33.

The rear foot height can be changed. Rotate the rear foot to the desired height, but the vertical distance from the bottom to the desk or floor should be 1" (25 mm) to make the projector horizontal on the flat surface.

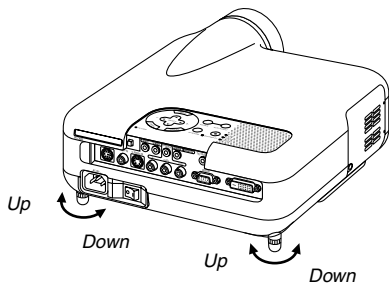

**CAUTION:**  
Do not use the tilt-foot for purposes other than originally intended. Misuses such as gripping the tilt-foot or hanging on the wall can cause damage to the projector.

**Zoom**  
Use the Zoom lever to fine adjust the image size on the screen.

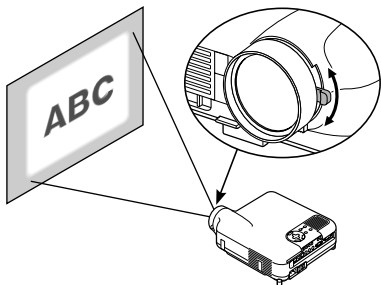

**Focus**  
Use the Focus ring to obtain the best focus.

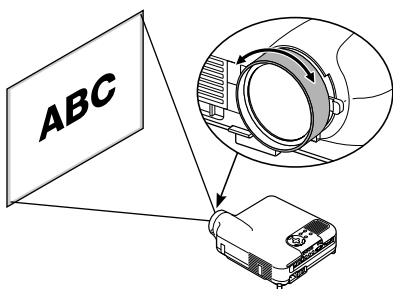

**Iris**  
Use the Iris lever underneath the lens to adjust the brightness and the contrast ratio optically.

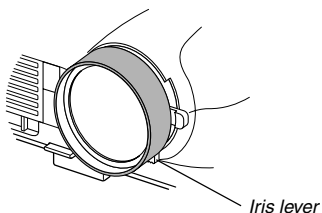

## Correcting the Horizontal and Vertical Keystone (3D Reform)

Use the 3D Reform feature to correct keystone (trapezoidal) distortion to make the top or bottom and the left or right side of the screen longer or shorter so that the projected image is rectangular. Two options are available for correcting procedures. Press the 3D REFORM button to toggle between Keystone and Cornerstone.

### Keystone

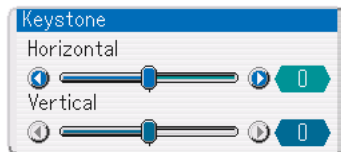

1. Press the SELECT ◀▶ button to adjust the horizontal keystone.
2. Press the SELECT ▲▼ button to select "Vertical".
3. Press the SELECT ◀▶ button to adjust the vertical keystone.
4. After completing, press the ENTER button.

### Cornerstone

1. Project an image so that the screen is smaller than the area of the raster.
2. Pick up any one of the corners and align the corner of the screen with the one of the image.

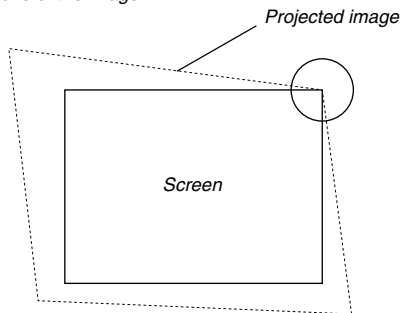

(The drawing shows the upper right corner.)

3. Press the 3D REFORM button on the remote control.



The Cornerstone adjustment screen is displayed.

**NOTE:** Press the 3D REFORM button to toggle between "Cornerstone" and "Keystone."

4. Use the SELECT ▲▼◀▶ button to select one icon which points in the direction you wish to move the projected image frame.

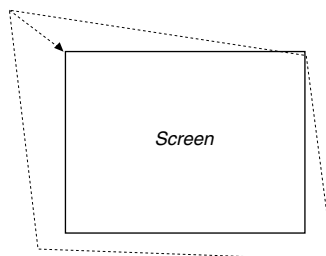

5. Press the ENTER button.
6. Use the SELECT ▲▼◀▶ button to move the projected image frame as shown on the example.
7. Press the ENTER button.

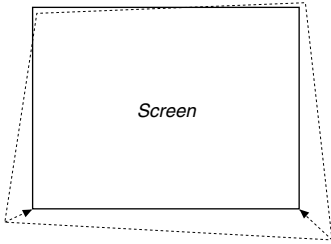

8. Use the SELECT ▲▼◀▶ button to select another icon which points in the direction.

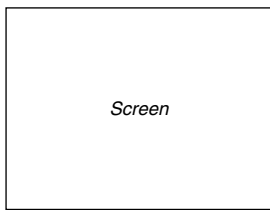

On the Cornerstone adjustment screen, select "Exit" or press the CANCEL button on the remote control.

The confirmation screen is displayed.

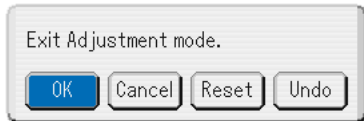

9. Press the SELECT ◀ or ▶ button to highlight the [OK] and press the ENTER button.

This completes the keystone correction. Selecting "Cancel" will return to the adjustment screen without saving changes (Step 3). Selecting "Reset" will return to the factory default. Selecting "Undo" will exit without saving changes.

**NOTE:** To return the 3D Reform correction setting values to the factory default, press and hold the 3D REFORM button for a minimum of 2 seconds.

**NOTE:** During 3D Reform adjustment, "Aspect Ratio" and "Screen" may not be available. Should this happen, first reset the 3D Reform data and then do each setting. Second repeat the 3D Reform adjustment. Changing Aspect Ratio and/or Screen setting can limit 3D Reform in its adjustable range.

The adjustable ranges for 3D Reform are as follows:  
 Horizontal ..... Max  $\pm 25^\circ$  approx.  
 Vertical ..... Max  $\pm 40^\circ$  approx.

\* The following are conditions at the above maximum angle when all of the following are met

- Image is projected in Wide (Zoom lever)
- Resolution is XGA  
 Higher resolution than XGA limits 3D Reform in its adjustable range.
- Menu items should be set as follows:  
 Aspect Ratio ..... Normal  
 Screen Type ..... 4:3
- Horizontal and Vertical are adjusted separately.  
 A combination of both adjustments limits 3D Reform in its adjustable range.
- When "Stadium" is selected in Aspect Ratio, "Cornerstone" and "Horizontal Keystone" are not available except Video, S-Video, 480p and 576p signals.

## Optimizing RGB Picture Automatically

### Adjusting the Image Using Auto Adjust

Optimizing RGB image automatically  
 Press the Auto Adjust button to optimize an RGB image automatically.

[Poor picture]

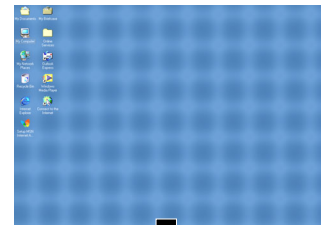
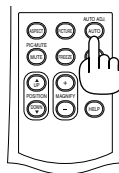

[Normal picture]

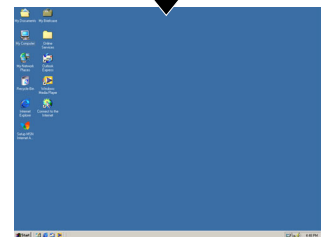

Press the Auto Adjust button to fine-tune the computer image or to remove any vertical banding that might appear and to reduce video noise, dot interference or cross talk (this is evident when part of your image appears to be shimmering). This function adjusts the clock frequencies that eliminate the horizontal banding in the image. This function also adjusts the clock phase to reduce video noise, dot interference or cross talk. (This is evident when part of your image appears to be shimmering.)

This adjustment may be necessary when you connect your computer for the first time.

**NOTE:**

- Some signals may not be displayed correctly or take time.
- The Auto Adjust function does not work for component and video signals and some RGB signals such as 1080i, 1080p and 720p.
- If the Auto Adjust operation cannot optimize the RGB signal, try to adjust Clock and Phase manually. See page E-32.

## Turning Up or Down Volume

Sound level from the speaker on the projector can be adjusted when the menu is not displayed.

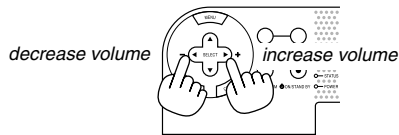
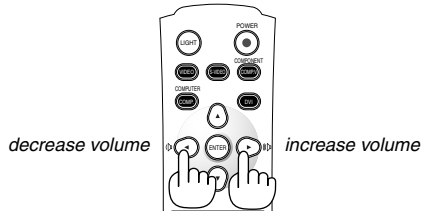

Volume bar



## Turning off the Projector

### To turn off the projector:

First press the POWER (ON/STAND BY) button on the projector cabinet or the POWER button on the remote control for a minimum of two seconds.

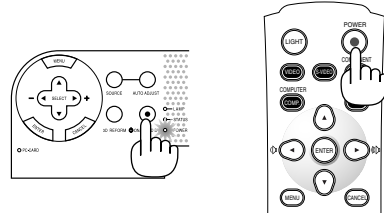

The power indicator will glow orange. After the projector turns off, the cooling fans keep operating for 90 seconds (Cooling-off time). Second, turn off the Main Power switch. The power indicator will go out. Last unplug the power cable.

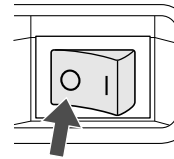

### CAUTION

Do not unplug the power cable from the wall outlet or do not turn off the main power under any one of the following circumstances. Doing so can cause damage to the projector:

- While the Hour Glass icon appears.
- While the message "Please wait a moment." appears. This message will be displayed after the projector is turned off.
- While the cooling fans are running. (The cooling fans continue to work for 90 seconds after the projector is turned off).
- While accessing a PC card. (The PC Card Access indicator lights.)

# CONVENIENT FEATURES

## Using Image Position

The POSITION button adjusts the position of an image when "Zoom", "V-Zoom" or "Cinema" is selected in Aspect Ratio.

See also "Adjusting the position of an image [Image Position]" on page E-32.

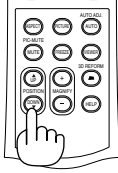

When "4:3" is selected in Screen Type:

Move the viewable area up or down

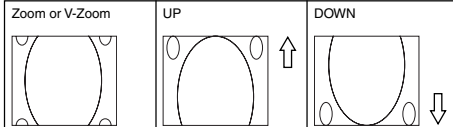

Move the position of an image up or down

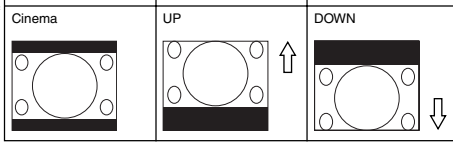

When "16:9" and "Anamorphic"(\*) are selected in Screen Type:

Move the viewable area up or down

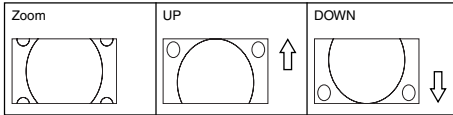

### Table of Availability for Image Position

For PC, DVD Progressive, 480p, 480i, 576p, 576i

Screen Type	Aspect Ratio					
	Normal	Full	Zoom	Cinema	V-Zoom	Stadium
4:3	Not available		Available	Available	Available	
16:9 Anamorphic*	Not available	Not available	Available			Not available

For 720p, 1080i, 1080p

Screen Type	Aspect Ratio					
	Normal	Full	Zoom	Cinema	V-Zoom	Stadium
4:3	Available		Not available	Available	Not available	
16:9 Anamorphic*	Not available					

\* A commercially available anamorphic lens is needed.

## Turning Off the Image and Sound

Press the PIC MUTE button to turn off the image and sound for a short period of time. Press again to restore the image and sound.



## Freezing a Picture

Press the FREEZE button to freeze a picture. Press again to resume motion.



## Capturing a Picture

You can capture a still image while freezing it.

1. Press the FREEZE button and then press the MENU button. The CAPTURE window will be displayed.

2. Press the ENTER button to capture the image.

**NOTE:** A "\_CAP\_" folder will be created and a captured image will be stored in the PC card inserted into the projector's slot.

3. Select "Exit" or press the CANCEL button to end the CAPTURE screen.

**NOTE:** To delete captured images, see "Deleting Captured Images" on page E-41.

## Enlarging and Moving a Picture

You can enlarge the area you want up to 400 percent.  
To do so:

To enlarge the image:

1. Press the **MAGNIFY(+)** button.

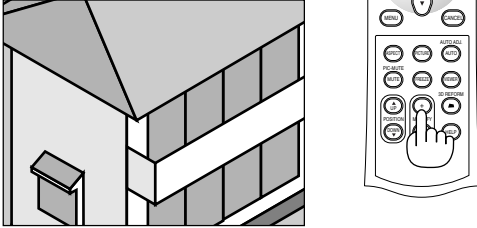

2. Press the **MAGNIFY(-)** button to return to its original size.

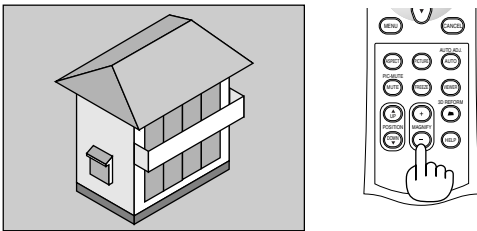

To enlarge the image:

Use the **SELECT** button to move the enlarged portion.

---

**NOTE:** The **FREEZE** button does not work when an image is magnified.

---

## Getting the On-line Help

You get the contents about Help.

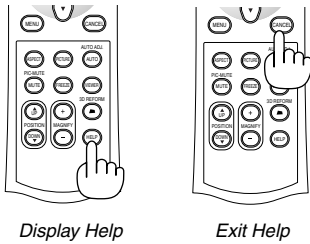



# USING ON-SCREEN MENU

## Using the Menu

1. Press the MENU button on the remote control or the projector cabinet to display the menu.

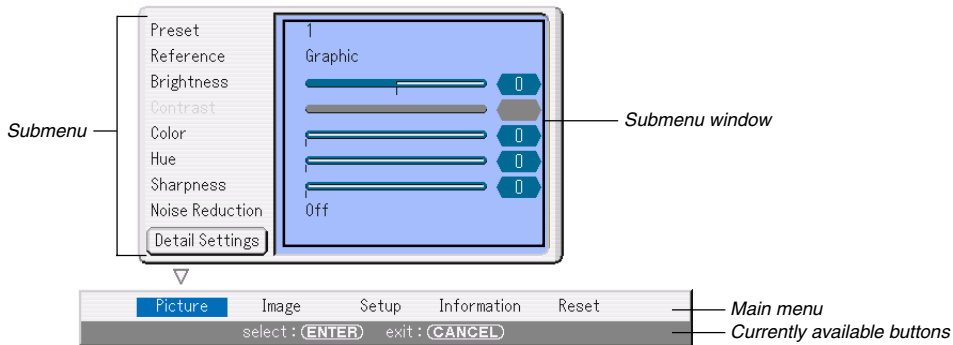

The Picture menu will be displayed (factory preset).

**NOTE:** The commands such as ◀▶, ENTER, CANCEL in the gray bar show available buttons for your operation.

2. Press the SELECT ◀▶ buttons on the remote control the projector cabinet to display the submenu.

3. Press the ENTER button on the remote control or the projector cabinet to highlight the top item or the first tab.

4. Use the SELECT ▲▼ buttons on the remote control or the projector cabinet to select the item you want to adjust or set. You can use the SELECT ◀▶ buttons on the remote control or the projector cabinet to select the tab you want.

**NOTE:** You can select a tab only when the tab color is blue.

5. Press the ENTER button on the remote control or the projector cabinet to display the submenu window.

**NOTE:** You can also display a submenu window by pressing the SELECT ▶ button.

6. Adjust the level or turn the selected item on or off by using the SELECT ▲▼◀▶ buttons on the remote control or the projector cabinet.

7. Press the ENTER button or the CANCEL button on the remote control or the projector cabinet. Changes are stored until you adjust it again.

ENTER ..... Stores changes.

CANCEL ..... Returns to the previous screen without storing changes.

8. Repeat steps 2 -7 to adjust an additional item, or press the CANCEL button on the remote control or the projector cabinet to quit the menu display.

## Menu tree

Main menu	Submenu		Items	
Picture	Preset		1 to 5	
	Reference		Video, Movie, Game, sRGB, Graphic	
	Brightness			
	Contrast			
	Color			
	Hue			
	Sharpness			
	Noise Reduction		Off, Low, Medium, High	
	Detail Settings	Page 1	Gamma Correction	Dynamic, Natural, Black Detail
			Color Temperature	5000, 5400, 6000, 6500, 7000, 7800, 8500, 9300, 10500
		Page 2	Brightness R	
			Brightness G	
			Brightness B	
			Contrast R	
			Contrast G	
			Contrast B	
		Page 3	Red	
Green				
Blue				
Yellow				
Magenta				
Cyan				
Page 4		SweetVision Mode	Off, On, Split	
		SweetVision Level	0 to 63	
	3D Y/C Separation	Off, On		
	Deinterlace	Off, On		
	Telecine	Off, Auto		
	Black Expansion	Off, 1, 2, 3, 4, 5		
	Contrast Enhancement	-3, -2, -1, Off, 1, 2, 3		
Image	Page 1	Aspect Ratio (4:3)	Normal, Zoom, Cinema, V-Zoom	
		(16:9, Anamorphic)	Normal, Full, Zoom, Stadium	
		Blanking	Top, Bottom, Left, Right	
		Position / Clock	Horizontal, Vertical, Clock, Phase	
		Image Position	-64 to 64	
		Overscan	0%, 5%, 10%	
		Signal Type	RGB, Component	
		Setup Level	Off, On	
	Page 2	Video Filter	Off, Less, More	
		Entry List		

Main menu	Submenu		Items	
Setup	Page 1	Screen	Screen Type	4:3, 16:9, Anamorphic
			Position	-64 to 64
		Orientation		Desktop Front, Ceiling Rear, Desktop Rear, Ceiling Front
		Lamp Mode		Normal, Eco
		Screen Trigger		Off, On
		Background		Blue, Black, Logo
		Language		English, Deutsch, Français, Italiano, Español, Svenska, Suomi, Norsk, Nederlands, Türkçe, Polski, Русский, Ελληνικά, Português, Česky, 日本語, 한국어, 中文
	Test Pattern			
	Page 2	Signal Select	Computer	RGB/Component, RGB, Component, Scart
			Video	Auto, NTSC3.58, NTSC4.43, PAL, PAL-M, PAL-N, PAL60, SECAM
			S-Video	Auto, NTSC3.58, NTSC4.43, PAL, PAL-M, PAL-N, PAL60, SECAM
		Standby Mode		Idle Mode, Power-saving Mode
		Fan Mode		Auto, High Speed
		Lamp Hour		Clear Lamp Hour Meter
		Auto Adjust		Off, Normal, Fine
	Page 3	Password (Logo)		Entry, Delete
		LAN Mode	IP Address	Automatic, Manual
				IP Address
				Subnet Mask
				Projector Name
		DHCP	DHCP	Gateway
				DNS Configuration
	Mail	Mail	Domain Name	
			Host Name Option	
			Client-Identifier Option	
	Status	Status	Alert Mail	
			Sender's Address	
Security		SMTP Server Name		
		Recipient's Address 1		
		Recipient's Address 2		
		Recipient's Address 3		
		Test Mail		
		IP Address, Subnet Mask, Gateway, Mac Address, Reconnect		
		Enable, Disable		
		Keyword		
		Use Protectkey, Read, Register, Delete		
Information	Page 1	Source Name, Input Terminal, Entry No., Horizontal Frequency, Vertical Frequency		
	Page 2	Signal Type, Video Type, Sync Type, Interlace, Sync Polarity		
	Page 3	Remaining Lamp Time, Lamp Hour Meter, Projector Usage		
	Page 4	Version (BIOS, Firmware, Data)		
Reset	Current Signal, All Data, All Data (Including Entry List)			

## Menu Elements

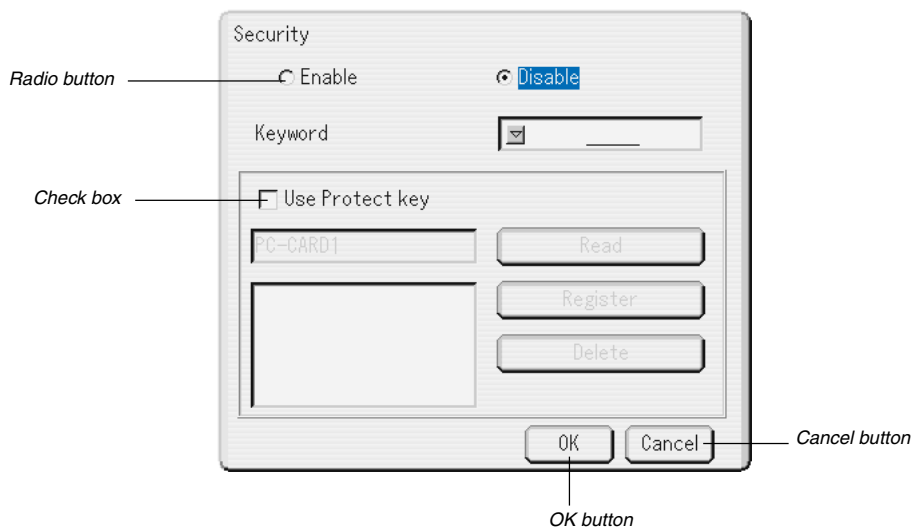
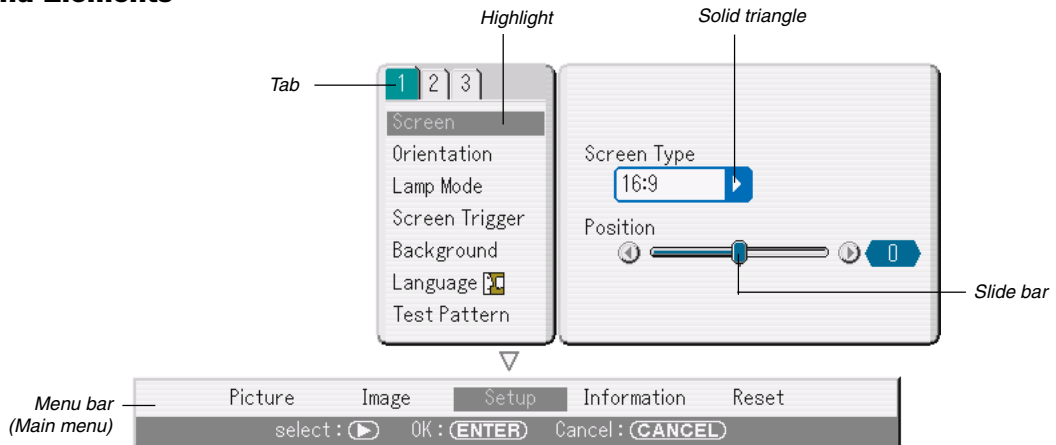

Menu windows or dialog boxes typically have the following elements:

- Highlight ..... Indicates the selected menu or item.
- Solid triangle ..... Indicates further choices are available. A highlighted triangle indicates the item is active.
- Tab ..... Indicates a group of features in a dialog box. Selecting on any tab brings its page to the front.
- Radio button ..... Use this round button to select an option in a dialog box.
- Check box ..... Place a checkmark in the square box to turn the option On.
- Slide bar ..... Indicates settings or the direction of adjustment.
- OK button ..... Press to confirm your setting. You will return to the previous menu.
- Cancel button ..... Press to cancel your setting. You will return to the previous menu.

# Menu Descriptions & Functions

## Picture

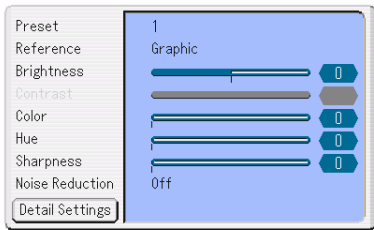

### [Preset]

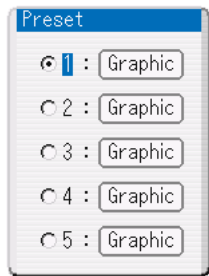

This option allows you to adjust neutral tint for yellow, cyan or magenta. There are 5 factory presets optimized for various types of images, you can set user adjustable settings.

### Selecting Reference Setting [Reference]

This feature allows you to use color correction or gamma values as reference data to optimize for various types of images. You can select one of the following five settings.

- Video ..... Recommended for regular picture such as TV program.
- Movie ..... Recommended for movie.
- Game ..... Recommended for playing a video game.
- sRGB ..... Standard color values.
- Graphic ..... Recommended for graphics.

### [Brightness]

Adjusts the brightness level or the back raster intensity.

### [Contrast]

Adjusts the intensity of the image according to the incoming signal.

### [Color]

Increases or decreases the color saturation level.

### [Hue]

Varies the color level from +/- green to +/-blue. The red level is used as reference. This adjustment is only valid for Video, Component and TV standard inputs.

### [Sharpness]

Controls the detail of the image for Video.

### Selecting Noise Reduction Level [Noise Reduction]

(not available for RGB, DVI and Viewer; available for TV standard inputs)

Select one of the three levels for reducing video noise: Low, Medium or High.

**NOTE:** The lower the Noise Reduction level, the better the image quality by way of higher video bandwidth.

### [Detail Settings]

This will provide you with a more detailed setting screen which has four pages.

#### [Page 1]

Selecting Gamma Correction Mode (Gamma Correction)

Each mode is recommended for:

- Dynamic ..... High-contrast picture.
- Natural ..... Natural reproduction picture.
- Black Detail .... Dark portions of a picture.

Adjusting Color Temperature (Color Temperature)

This feature adjusts the color temperature using the slide bar. The range is between 5000 and 10500K.

#### [Page 2]

Adjusting White Balance (White Balance)

This allows you to adjust the white balance. Brightness for each color (RGB) is used to adjust the black level of the screen; Contrast for each color (RGB) to adjust the white level of the screen.

#### [Page 3]

Selecting Color Correction (Color Correction)

Adjusts red, green, blue, yellow, magenta, cyan and color gain each independently to correct the tint on whole screen.

#### [Page 4]

SweetVision Mode

The SweetVision feature provides improvement of contrast using a proprietary detail enhancement technology.

**NOTE:** This feature is not available for HDTV and PC (RGB) signals.

- Off ..... Turns off the SweetVision feature.
- On ..... Turns on the SweetVision feature.
- Split ..... Turns on or off to show the effect of the SweetVision.

SweetVision Level

When the SweetVision Mode is On, you can adjust the SweetVision level.

3D Y/C Separation

This option turns on or off the 3 dimension separation feature.

**NOTE:** This feature is available for NTSC3.58 of Video signal only.

Item \ Signal	RGB (PC)	RGB (TV)	DVI (PC)	DVI (TV)	Video/S-Video/Component	Scart
Brightness	Yes	Yes	No*	Yes	Yes	Yes
Contrast	Yes	Yes	No*	Yes	Yes	Yes
Color	No	Yes	No	Yes	Yes	Yes
Hue	No	Yes	No	Yes	Yes	Yes
Sharpness	No	Yes	No	Yes	Yes	Yes
Noise Reduction	No	Yes	No	Yes	Yes	Yes

Yes=Available, No=Not available \* You can use White Balance to adjust this item. See "Adjusting White Balance (White Balance)" on this page.

### Deinterlace

Turns on or off the deinterlace function.

On ..... Default standard setting.

Off ..... Select this option if there are some jitter or artifacts in video.

**NOTE:** This feature is not available for Scart, 480p, 576p, and non-1080i HDTV and RGB signals.

Telecine (available only when "Deinterlace" is on)  
Use 3:2 pull down correction to eliminate jitter and artifacts in video.

Auto ..... For film source such as a DVD player.

Off ..... For signals other than film sources.

### Black Expansion

Minimizes blacks that appear more like shades of gray to provide a true black and white image at high contrast.

Off/1/2/3/4/5

**NOTE:** This feature is not available for Scart, 480p, 576p, HDTV and RGB signals.

### Contrast Enhancement

This option allows you to provide a high contrast image in a bright scene.

-3/-2/-1/Off/1/2/3

**NOTE:** This feature is available for TV standard signals only.

## Image [Page 1]

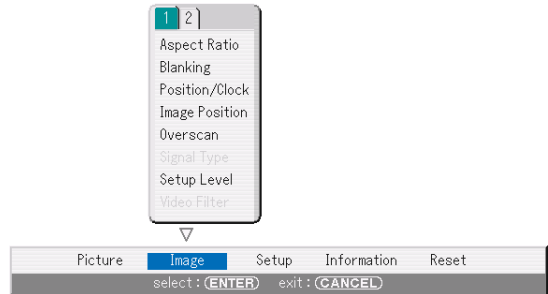

### Selecting Aspect Ratio [Aspect Ratio] (not available for Viewer)

Aspect Ratio allows you to select the best Aspect mode to display your source image.

When screen size 4:3 is selected for the source, the following selections will display:

Normal ..... Standard 4:3 Aspect.

Zoom ..... All 4 sides stretched.

Cinema ..... Top and bottom reduced to display with black borders on top and bottom. Available for 4:3 signals only.

V-Zoom ..... Top and bottom stretched. Available for 4:3 signals only.

When screen size 16:9 and Anamorphic are selected for the source, the following selections will display:

Normal ..... 16:9 image displayed in 4:3 mode.

Full ..... Stretched to display in 16:9 aspect ratio. Available for 16:9.

Zoom ..... All 4 sides stretched.

Stadium ..... Non-linearly stretched. Available for 16:9 only.

**NOTE:** You can adjust image positions vertically for source with black borders. See page E-23 for setting image positions.

### Copyright

Please note that using this projector for the purpose of commercial gain or the attraction of public attention in a venue such as a coffee shop or hotel and employing compression or expansion of the screen image with an "Aspect Ratio" or "Screen" setting may raise concern about the infringement of copyrights which are protected by copyright law.

**NOTE:** During 3D Reform adjustment, "Aspect Ratio" may not be available. Should this happen, first reset the 3D Reform data and then do setting again. Second repeat the 3D Reform adjustment.

Changing the aspect ratio can limit 3D Reform in its adjustable range.

When screen size 4:3 is selected for the source, the following selections will display.

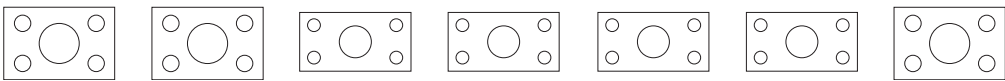

mode \ input	480i/576i	DVD progressive	480p/576p	720p	1080i	1080p	PC(RGB)
	These are the same signals.						
Normal							
Zoom							
Cinema							
V-Zoom							

When screen size 16:9 and Anamorphic (\*) are selected for the source, the following selections will display.

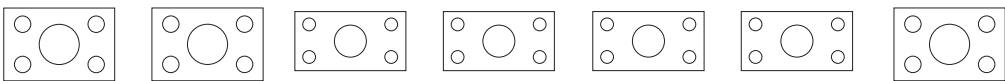

mode \ input	480i/576i	DVD progressive	480p/576p	720p	1080i	1080p	PC(RGB)
	These are the same signals.						
Normal							
Full				-	-	-	
Zoom				-	-	-	
Stadium				-	-	-	

\* A commercially available anamorphic lens is needed.

### Masking Unwanted Area [Blanking]

This feature allows you to mask any unwanted area of the screen image.

Adjust the Top, Bottom, Left or Right blanking with the SELECT ◀ or ▶ button.

### Adjusting Position and Clock [Position / Clock]

This allows you to manually adjust the image horizontally and vertically, and adjust Clock and Phase.

Horizontal/Vertical Position:

Adjusts the image location horizontally and vertically using the SELECT ◀ and ▶ buttons.

Clock ..... Use this item to fine tune the computer image or to remove any vertical banding that might appear. This function adjusts the clock frequencies that eliminate the horizontal banding in the image.

Press the SELECT ◀ and ▶ buttons until the banding disappears. This adjustment may be necessary when you connect your computer for the first time.

Phase ..... Use this item to adjust the clock phase or to reduce video noise, dot interference or cross talk. (This is evident when part of your image appears to be shimmering.) Use the SELECT ◀ and ▶ buttons to adjust the image.

Use "Phase" only after the "Clock" is complete.

### Adjusting the position of an image [Image Position]

This option is available only when "Zoom", "V-Zoom" and "Cinema" are selected in the "Aspect Ratio".

See page E-23 for more details.

### Selecting Overscan Percentage [Overscan]

Select overscan percentage (0%, 5% and 10%) for signal.

**NOTE:** When "Stadium" is selected in "Aspect Ratio", this feature is not available.

**NOTE:** The "0%" option may not be available depending upon the input signal.

### Selecting Signal Type [Signal Type]

Select either the computer signal type or the component signal type.

RGB ..... Computer signal

Component .... Component signals such as Y/Cb/Cr, Y/Pb/Pr

**NOTE:** This feature is available on the computer signal only. If you do not get a better picture even when you set "Signal Select" to "Component" in Setup, set this to "Component".

### [Setup Level]

Corrects grayish black so that a black image or dark image looks true black. To turn on this feature, Select "On".

### Selecting Video Filter Level [Video Filter] (not available for Video, DVI, Component 15kHz and Viewer)

This function reduces video noise.

Off ..... The filter is removed.

Less ..... The low-pass filter is applied partially.

More ..... The low-pass filter is applied fully.

## Image [Page 2]

### [Entry List]

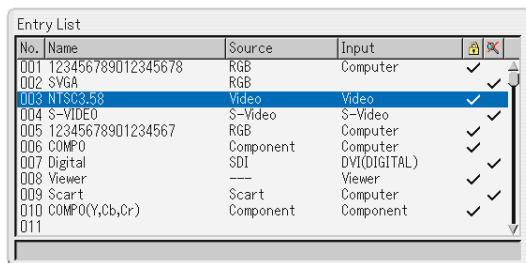

No.	Name	Source	Input	
001	123456789012345678	RGB	Computer	✓
002	SVGA	RGB		✓
003	N1SC3.58	Video	Video	✓
004	S-VIDEO	S-Video	S-Video	✓
005	12345678901234567	RGB	Computer	✓
006	COMP0	Component	Computer	✓
007	Digital	SDI	DVI(DIGITAL)	✓
008	Viewer	---	Viewer	✓
009	Scart	Scart	Computer	✓
010	COMP0(Y,Cb,Cr)	Component	Component	✓
011				

Displays the list of the entry signals. Use the SELECT ▲▼ buttons on your remote control or the projector cabinet to select the signal and press the ENTER button on the remote control or the projector cabinet to display the Entry Edit Command screen.

Using the Entry List:

Making any adjustments to the current picture will automatically register its adjustments to the Entry List. The registered signal can be loaded any time from the Entry List.

**NOTE:** Up to 100 presets can be registered except settings on the Picture.

Entry Edit Command:



You can edit signals on the Entry List.

Load ..... Enables you to select a signal from the list.

Store ..... Enables you to store the currently projected signal.

Cut ..... Enables you to remove a selected signal from the list and place it on the "clipboard" in the projector.

Copy ..... Enables you to copy a selected signal from the list and place it on the "clipboard" in the projector.

Paste ..... Enables you to paste the signal placed on the "clipboard" to any other line of the list. To do this, select "Paste" and then select the line number you want to paste to. Last press ENTER.

Edit ..... Enables you to change source names.

#### Source Name:

Enter a signal name. Up to 18 alphanumeric characters can be used.

#### Input Terminal:

Change the input terminal. Video and S-Video are available for composite signal. Component and Computer are available for component signal.

#### Lock:

Set so that the selected signal cannot be deleted when "All Delete" is executed.

#### Skip:

Set so that the selected signal will be skipped during auto search.

When complete, select OK and press ENTER. To exit without storing setting, select Cancel. Select "Source Name" and press ENTER to display the Source Name Edit window. You can change source name on this window. Press ▼ to display the software keyboard, which you can enter alphanumeric characters. See page E-50 for the key function of the software keyboard.

All Delete ..... This feature enables you to delete all the registered signals in the Entry List.



The following buttons are not available for the currently projecting signals:

- 1) The Cut and Paste buttons on the Entry Edit Command screen
- 2) The Input Terminal button on the Entry Edit screen

**NOTE:** When all the signals in the Entry List are deleted, the currently projected signal will be also deleted except locked signals.

## Setup [Page 1]

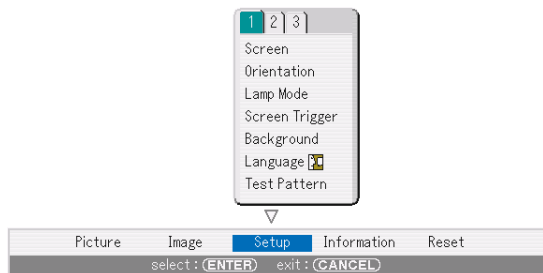

### Selecting Aspect Ratio and Position for Screen [Screen]

#### Screen Type:

Select one of three options: 4:3 Screen, 16:9 Screen or Anamorphic for the screen to be used. See also "Aspect Ratio" on pages E-30 and E-31.

#### Position:

This feature adjusts the vertical position of the image when viewing video with an aspect ratio selected.

When some aspect ratios are selected in Image, the image is displayed with black borders on the top and bottom.

You can adjust the vertical position between top and bottom.

Some DVI signals are available on one screen type only, but there are some equipment with DVI output which is available on both 4:3 and 16:9. See page E-49 for supported signals.

**NOTE:** This option is available only when "16:9" is selected in Screen Type.

**NOTE:** During 3D Reform adjustment, "Screen Type" and "Screen Position" may not be available. To make available, first reset the 3D Reform data and then do settings again. Secondly repeat the 3D Reform adjustment. Changing "Screen Type" and "Screen Position" can limit 3D Reform in its adjustable range.

### Selecting Projector Orientation [Orientation]

This reorients your image for your type of projection. The options are: desktop front projection, ceiling rear projection, desktop rear projection, and ceiling front projection.

### Setting Lamp Mode to Normal or Eco [Lamp Mode]

This feature enables you to select two brightness modes of the lamp: Normal and Eco modes. The lamp life can be extended up to 3000 hours by using the Eco mode.

Normal Mode . This is the default setting (100% Brightness).

Eco Mode ..... Select this mode to increase the lamp life (80% Brightness).

### Enabling Screen Trigger [Screen Trigger]

When "Screen Trigger" is selected and the projector is powered ON, the screen trigger output sends a low voltage trigger to the screen controller and the screen will go down. When the projector is powered OFF the screen trigger stops sending a low voltage trigger to the screen controller and the screen will go up. Use a commercially available stereo mini cable.

### Selecting a Color or Logo for Background [Background]

Use this feature to display a blue/ black screen or logo when no signal is available. The default background is blue. You can change the logo screen using the Viewer feature. See pages E-42.

## Selecting Menu Language [Language]

You can choose one of 18 languages for on-screen instructions.

## [Test Pattern]

Displays a test pattern for adjustment or setting.

Selecting this item will display the test pattern.

To turn off the test pattern, select a source such as Video, S-Video, Component, Computer, DVI(DIGITAL) or Viewer.

## Setup [Page 2]

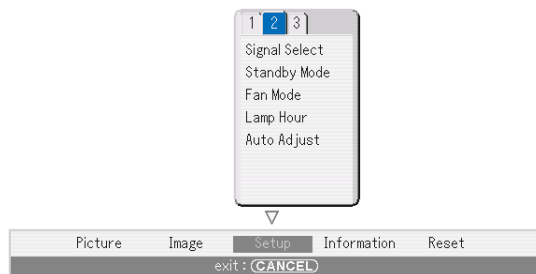

### Selecting Signal Format [Signal Select]

#### Computer:

Allows you to choose "RGB" for an RGB source such as a computer, or "Component" for a component video source such as a DVD player. Normally select "RGB/Component" and the projector automatically detects an either incoming signal. However there may be some component signals that the projector is unable to detect. If this is the case, select "Component". Select "Scart" for the European Scart.

#### VIDEO and S-VIDEO:

This feature enables you to select composite video standards manually. Normally select "Auto". Select the video standard from the pulldown menu. This must be done for Video and S-Video separately.

### Selecting Standby Mode [Standby Mode]

The projector has two standby modes: Idle mode and Power-saving mode.

Power-saving mode is the mode that allows you to put the projector in the standby condition which consumes less power than the Idle mode. The projector is preset for Idle mode at the factory.

**NOTE:** The HTTP server functions are not available during Power-saving mode.

### Enabling High Speed Fan Mode [Fan Mode]

This option allows you to select two modes for fan speed: High speed mode and Auto mode.

High speed .... The built-in fans run at a fixed high speed.

Auto ..... The built-in fans automatically run at a variable speed according to the internal temperature.

When you wish to cool down the temperature inside the projector quickly, select "High Speed".

**NOTE:** Select High speed mode if you continue to use the projector for consecutive days.

### Clearing Lamp Hour Meter [Lamp Hour]

Resets the lamp clock back to zero. Pressing this button appears a confirmation dialog box. To reset the lamp usage hour, press "OK".

**NOTE:** The projector will turn off and go into standby mode after 2100 hours (up to 3100 hours in Eco mode) of service. In this condition you cannot clear the lamp hour meter on the menu. If this happens, press the "HELP" button on the remote control for ten seconds to reset the lamp clock back to zero. Do this only after replacing the lamp.

### Setting Auto Adjust

This feature sets the Auto Adjust mode so that the RGB image can be automatically or manually adjusted for noise and stability. You can automatically make adjustment in two ways: Normal and Fine

- Off ..... The RGB image will not be automatically adjusted. You can manually optimize the RGB image.
- Normal ..... Default setting. Normally select this option.
- Fine ..... Select this option if fine adjustment is needed. It takes more time to switch to the source than when "Normal" is selected.

### Setup [Page 3]



### Setting a Password [Password (Logo)]

A password can be set for your projector to avoid operation by an unauthorized person.

When a password is set, doing any one of the following two operations will display the Password input screen.

- \* Changing the background
- \* Changing the logo data in a PC card

#### Entry:

To assign your password:

**NOTE:** Up to 15 alphanumeric characters can be assigned.

1. Type a password. Highlight "Entry" and press the ENTER button.

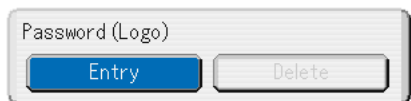

The "Enter the Password" screen will be displayed.

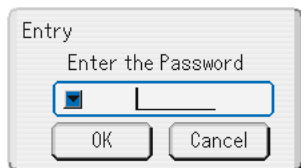

Make sure that  is highlighted and then press the ENTER button. The Software keyboard appears. Use the Software keyboard to type a password and then highlight "OK" on the "Enter the Password" screen and press the ENTER button. The [Confirm Password] screen will be displayed.

2. Type the same password again. Highlight "OK" on the "Enter the Password" screen and press the ENTER button. Your password will be assigned.

#### Delete:

To delete your password:

1. Highlight [Delete] and press the ENTER button. The "Current Password" screen will be displayed.



2. Use the Software keyboard to type your password. Highlight "OK" on the "Current Password" screen and then press the ENTER button. Your password will be deleted.

### Setting LAN Mode [LAN Mode]

This feature allows you to set various setting items when the projector is used on your network.

Consult with your network administrator about these settings.

**CAUTION:** Make sure that the LAN card is removed during Power-saving mode (NOT Idle mode) or with the main power off. Failure to do so may cause damage to the data on your PC card.

#### Note to Users of a PCMCIA network card:

Use of a non-supported network card in the projector may cause the unit to malfunction.

Should this happen, turn off the projector and remove the network card from the projector's PC card slot.

**NOTE:** LAN card is not available when a PC card is used for the Viewer function. Viewer is not available when LAN card is used for LAN connection.

#### IP Address:

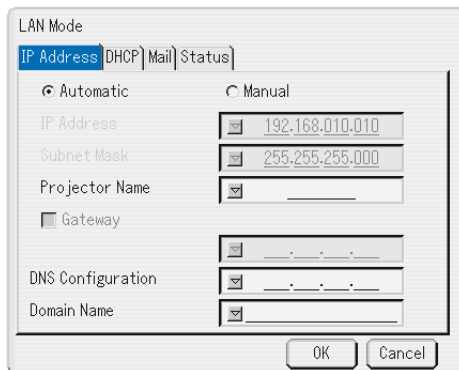

An IP address can be automatically assigned to this projector by your DHCP server. If your network does not automatically assign IP address, ask your network administrator for an address, and then register it manually.

#### Automatic:

Automatically assigns an IP address to the projector from a DHCP server.

#### Manual:

Provides a space for you to register the IP address or subnet mask number obtained from your network administrator.

#### IP Address:

Set your IP address. Press  to display the software keyboard and type in 12 numeric characters.

#### Subnet Mask:

Set your subnet mask number. Press  to display the software keyboard and type in 12 numeric characters.

#### Projector Name:

Specify a unique projector name. Press  to display the software keyboard and type in. Up to 16 alphanumeric characters can be used.

**Gateway:**

Set the default gateway of the network connected to the projector. Press to display the software keyboard and type in 12 numeric characters. Checking this box will make the set default route valid. When data is sent from the LAN card, the transfer location will be searched according to the previously set routing information; however, when the transfer location has not been found as a result of the search, the data will be sent to the device that holds the IP address set here. The IP address that is set here must be one that can be identified by a search of the routing information.

**DNS Configuration:**

Type in the IP address of DNS server on the network connected to the projector. 12 numeric characters are used.

**Domain Name:**

Type in domain name of the network connected to the projector. Up to 60 alphanumeric characters can be used.

**DHCP:**

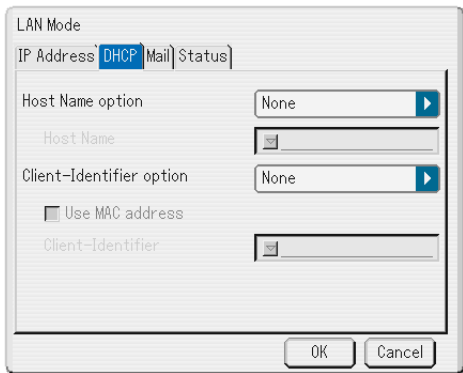

Depending on your network environment, acquiring an IP address from a DHCP server may not be possible. Should this happen, consult your network administrator to make changes to the following settings.

**Host Name option:**

- Select whether or not to add option hostname for DHCP.
- None ..... Not add
- Request ..... Add at the time of DHCP\_REQUEST.
- Discover/Request ..... Add at the time of DHCP\_DISCOVER and DHCP\_REQUEST.

**Host Name:**

Type in a hostname. This field is available only when "Request" or "Discover/Request."

**Client-identifier option:**

- Select whether or not to add option client identifier for DHCP.
- None ..... Not add
- Request ..... Add at the time of DHCP\_REQUEST.
- Discover/Request ..... Add at the time of DHCP\_DISCOVER and DHCP\_REQUEST.

**Use MAC address:**

Turn on to use MAC address for Client-identifier.

**Client-identifier:**

Type in a client identifier.

**Mail:**

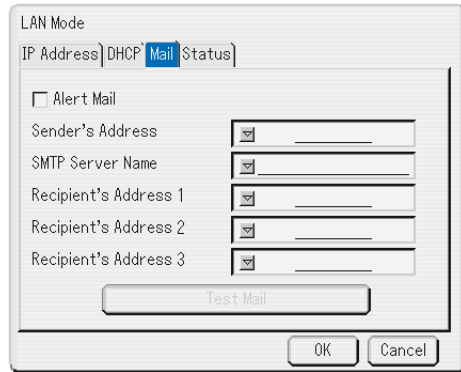

**Alert Mail:**

Checking this box enables Alert Mail feature.

This option notifies your computer of an error message via e-mail when using wired LAN. The error message will be notified when the projector lamp has reached the end of its usable life or an error occurs in the projector.

Sample of a message sent from the projector:

```
The lamp is at the end of its usable life. Please replace the lamp.
Projector Name: X X X X
Lamp Hour Meter: xxxx [H]
Projector Usage: xxxxxx [H]
```

**Sender's Address:**

Specify the senders address. Use the Software keyboard. Up to 60 alphanumeric and symbols characters can be used. See "Using Software Keyboard" in Appendix for more details.

**SMTP Server Name:**

Type in the SMTP server name to be connected to the projector. Up to 60 alphanumeric characters can be used.

**Recipient's Address 1 to 3:**

Type in your recipient's address. Up to 60 alphanumeric and symbols characters can be used.

**Test Mail:**

Send a test mail to check if your settings are correct.

**NOTE:** If you entered an incorrect address in a test, you may not receive an Alert mail. Should this happen, check if the Recipient's Address is correctly set.

**NOTE:** Unless any one of the "Sender's Address", "SMTP Server's Name" or "Recipient's Address 1-3" is selected, "Test Mail" is not available.

**NOTE:** Be sure to highlight "OK" and press the ENTER button before executing "Test Mail".

Status:

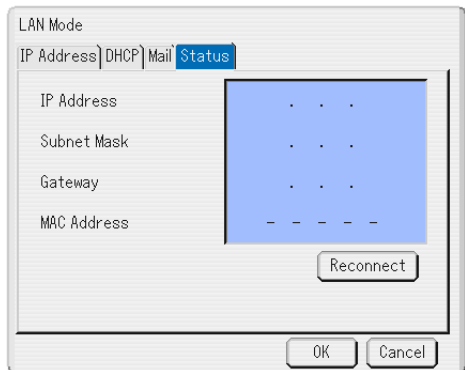

Displays the status of the LAN settings.

- IP Address ..... Indicates the IP address of the projector.
- Subnet Mask .. Indicates the subnet mask of the projector.
- Gateway ..... Indicates the gateway of the network connected to the projector.
- MAC Address . Indicates the MAC address of the LAN card.
- Reconnect ..... Use this button to connect the projector to a network.

### Security

The Security function enables you to protect your projector so that the projector will not project a signal unless you enter a keyword. There is also an option to lock the projector by using a registered PC card as a protect key. Once you have registered your PC card as a protect key, you are required to insert the registered PC card into the PC card slot of the projector each time you turn on the projector. You can enable the Security function by using a keyword only.

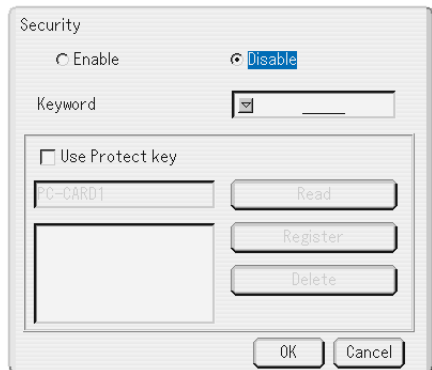

- Enable/Disable ..... This turns the Security function on or off.
- Keyword ..... Enter an appropriate keyword when you use the Security function. (Up to 10 characters can be used.) The Security function is available only when your keyword is entered.
- Use Protect key .... Check this box to lock your projector when using a PC card. To use a keyword without a PC card, do not check this box.
- Read ..... Reads data of a PC card.
- Register ..... Registers data of the PC card. The Security function is not available unless at least one PC card is registered. (If the "Use Protect key" check box is selected) Up to 5 PC cards can be registered.
- Delete ..... Deletes data of a registered PC card.

**To set up a keyword to enable the Security function without using a registered PC card.**

1. Use the SELECT ▲▼ button to select "Keyword" and use the software keyboard to enter a keyword.

**NOTE:** Please make a note of your keyword.

2. Use the SELECT ▲▼ button to select "Enable" and use the SELECT ▲▼ button to select "OK", then the Security function will be enabled. An "Are you sure?" message will appear. Use the SELECT ◀▶ button to select "OK" and press the ENTER button.

The Security function takes effect.

**To register a PC card as a protect key.**

1. Insert a PC card into the PC card slot of the projector.
2. Use the SELECT ▲▼ button to select "Use Protect Key" and press the ENTER button.
3. Use the SELECT ▲▼ button to select "Read" and press the ENTER button. Data of the PC card will be read into the projector.
4. Use the SELECT ▲▼ button to select "Register" and press the ENTER button. Downloaded data will be registered and be displayed in the list window.
5. Use the SELECT ▲▼ button to select "Keyword" and use the software keyboard to enter a keyword.

**NOTE:** To use a PC card as a protect key, you must also set up a keyword. Please make a note of your keyword.

This completes registration of your PC card.

To enable Security, use the SELECT ▲▼ button to select "Enable" and use the SELECT ▲▼ button to select "OK" and the Security function will be enabled. An "Are you sure?" message will appear. Use the SELECT ◀▶ button and press the ENTER button. The Security function takes effect.

**To turn on the projector when Security is enabled (when using your keyword only).**

1. Press and hold the POWER button for a minimum of two seconds. The projector will be turned on and display a message to the effect that the projector is security-protected.
2. Select [Setup] → [Page 3] → [Security] from the menu and press the ENTER button. The Release Code input screen will be displayed.
3. Enter your keyword in the Release Code input screen. You can view the projected image.

**NOTE:** Do not forget your keyword. However, if you forget your keyword, NEC or your dealer will provide you with your Release Code. See more information at the end of this section.

**To turn on the projector when Security is enabled (when using PC card as a protect key).**

1. Insert your registered PC card into the PC card slot.
2. Press and hold the POWER button for a minimum of two seconds. The projector will turn on and then recognize the PC card. Once the image has been projected, it will stay on without the PC card.

- The security disable mode is maintained until the main power is turned off (by setting the main power switch to "O" or unplugging the power cord). In the following cases you will be asked to check the protect key or input the keyword:
  - (1) When "OK" is selected at an image for which security is set and the power is turned off then back on
  - (2) When the main power is turned off then back on while the security function is enabled
  - (3) When you attempt to display an image for which security is set while the security function is enabled
- Blanks (spaces) cannot be used in the Keyword section.

#### To delete PC card data you registered.

1. Use the SELECT ▲▼ button to select "Delete" and use the SELECT ◀ button to select the list window.
2. Use the SELECT ▲▼ button to select the PC card data you wish to delete.
3. Press the SELECT ▶ button to select "Delete" and press the ENTER button.

The PC card data will be deleted.

#### If you've lost your registered PC card, proceed as follows:

**NOTE:** NEC or your dealer will provide you with your Release Code in exchange for your registered keyword and Request Code. See more information at the end of this section.

1. Press and hold the POWER button for a minimum of two seconds. The projector will be turned on and display a message to the effect that the projector is security-protected.
  2. Select [Setup] → [Page 3] → [Security] from the menu and press the ENTER button. The Release Code input screen will be displayed as well as your Request Code (24 alphanumeric characters).
  3. Enter your Release Code in the Release Code Input screen. The projector will turn on.
- \* If the projector is turned on by entering the Release Code, your Security will be disabled.

**NOTE:**

- \* Some types of PC cards cannot be registered as your protect key.
- \* It is recommended that you register two or more PC cards in case you lose or damage your registered PC card.
- \* Formatting your registered PC card will disable your protect key function.

**NOTE:**  
 For additional information visit:  
 US : <http://www.necvisualsystems.com>  
 Europe : <http://www.nec-europe.com/>  
 Global : <http://www.nec-pj.com/>

## Information

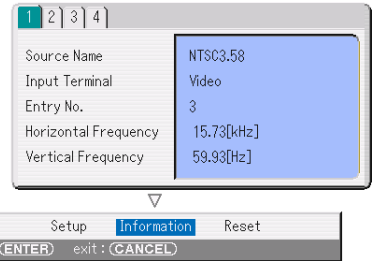

Displays the status of the current signal, and the lamp and the projector usage hours. This dialog box has four pages. The information included are as follows:

- [Page 1] Source Name  
Input Terminal  
Entry No.  
Horizontal Frequency  
Vertical Frequency
- [Page 2] Signal Type  
Video Type  
Sync Type  
Interlace  
Sync Polarity
- [Page 3] Remaining Lamp Time (%)  
Lamp Hour Meter (H)  
Projector Usage (H)
- [Page 4] Version (BIOS, Firmware, Data)

**NOTE:** The progress indicator shows the percentage of remaining bulb life. The value informs you of the amount of lamp and projector usage respectively.

#### Remaining Lamp Time Display

When the remaining lamp time reaches 0, the Remaining Lamp Time bar indicator changes from 0% to 100 Hours and starts counting down. If the remaining lamp time reaches 0 hours, the projector will not turn on regardless of whether the lamp mode is set to Normal or Eco.

#### Returning to Factory Default [Reset]

The Factory Default feature allows you to change adjustments and setting to the factory preset for source except the following:

##### Current Signal:

Resets the adjustments for the current signal to the factory preset levels.

All the items in "Volume", "Image (except Image Position)" and "Picture" can be reset.

##### All Data:

Reset all the adjustments and settings for all the signals to the factory preset except Remaining Lamp Time, Lamp Hour Meter, Projector Usage, Language, Background, Entry List, Standby Mode, LAN Mode, Security and Password (Logo).

(To reset the lamp usage time, see "Clearing Lamp Hour Meter" on page E-33)

##### All Data (Including Entry List):

Also deletes all the signals in the Entry List and returns to the factory preset.

# USING THE VIEWER

## Making the Most out of the Viewer Function

### Features

You can view graphic data, captured images, and play images on the projector. A PC memory card (referred to as PC card in this manual) is used to view data prepared on the computer and to capture and play images projected with the projector.

The Viewer feature allows you to view slides stored on a PC card on the projector.

Even if no computer is available, pictures taken by a digital camera can be viewed simply with the projector. This feature is convenient for playing images taken on digital cameras.

### Easy to use

- Viewer can be started immediately simply by inserting a PC card (not supplied)
- Easy slide switching
- Remote control operation
- Jumping to list of slides or any specific slide

### High quality images

- High resolution up to 1024 x 768 dots
- 24-bit full color playback
- Viewing of digital camera images

## Inserting and Removing a PC Card

### Inserting the PC Card

- Hold the PC card horizontally and insert it slowly into card slot with its top facing up.
- The eject button pops out once the PC card is fully inserted. Check that the PC card is fully inserted.

**NOTE:** Do not try to force the PC card into the slot.

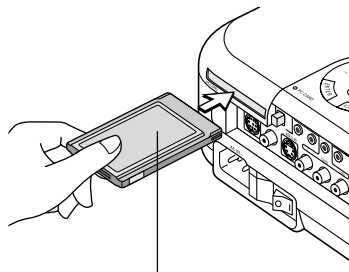

PC card (not supplied)

### Removing the PC Card

Press the eject button. The PC card pops out a little. Grasp the edges of the PC card and pull it out.

**NOTE:** Do not eject the PC card while its data is being accessed.

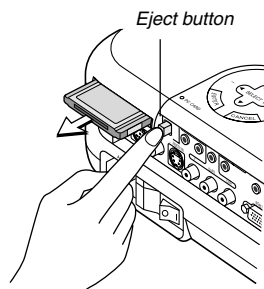

## Direction for Inserting the PC Card

The PC card has a top and bottom and must be inserted into the PC card slot in a specific direction. It cannot be inserted backwards or upside-down. Attempting to force it into the slot in the wrong direction may break the internal pin and damage the card slot. Refer to the PC card's operating instructions for the proper direction of insertion.

## PC Card Type

The PC Card slot accepts PCMCIA Type II only.

## Operating the Viewer Function from the Projector (playback)

This section describes the operation for showing slides created using the Viewer function with the projector. It is also possible to make slides directly from the images projected with the projector.

### Projecting slides (Viewer)

Preparation: Use the Capture feature to store JPEG or BMP files in a PC card inserted into the projector's slot. Or store JPEG or BMP files in a PC card inserted into your PC's slot.

1. Insert a PC card into the PC card slot of the projector.
2. Press the VIEWER button on the remote control or select the "Viewer" from the source list.  
An image stored in the PC card will be displayed.
3. Press the MENU button to display the Viewer menu.
4. Select "Play" and then press the ENTER button to display the first slide or to start playing slides automatically.

Checking "Start", means that selecting Viewer input displays a list of the folders in the PC card and if "Auto Play" is checked the projector automatically starts to play slides at the first slide of the folder you have selected.

The viewer menu will appear when you press the MENU button on the remote control or the projector cabinet.

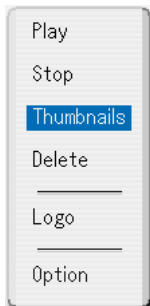

The viewer menu includes the following commands:

- Play ..... Plays back automatically or manually depending on the setting of Option. This allows you to move on to the next slide when "Manual Play" is selected in the "Play Mode".
- Stop ..... This allows you to stop Auto Play while you are playing back and to resume playing from the selected slide or folder when "Auto Play" is selected in the "Play Mode".
- Thumbnails . Displays a list of thumbnails of JPEG or BMP files stored in the PC card inserted into the projector.
- Delete ..... Deletes a captured slide(s) or all the captured slides in the Capture - specific folder.
- Logo ..... Replace the default background logo with another logo in JPEG or BMP format.
- Option ..... Displays the viewer setting options.

## Setting Option for Viewer

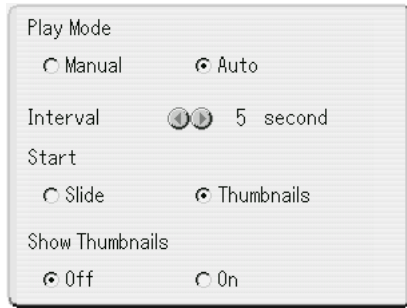

Play Mode:

- Auto ..... Plays back slides automatically when the Viewer source is selected.
- Manual ..... Views a slide manually when the Viewer source is selected.
- Interval ..... Specifies interval time between 5 and 300 seconds.
- Start ..... Specifies start screen when the Viewer source is selected.

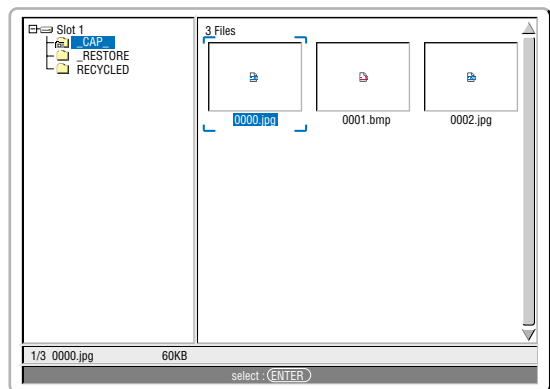

Show Thumbnails ..... Selecting the Viewer source will display a list of thumbnails of JPEG or BMP files stored in the PC card when "On" is selected.

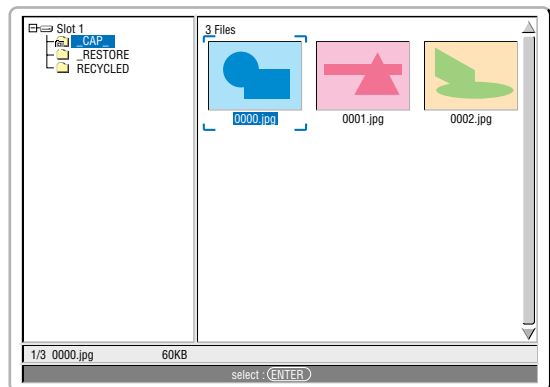

**NOTE:** If no memory card is inserted in the PC CARD slot, there is no signal, and a black, blue or logo background is displayed, depending on the setting. Playback is stopped when ◀▶ button on the cabinet or remote control is pressed in Auto Play mode.

## Switching to Slides Directly from Other Input Modes

With this function it is possible to switch directly to a slide when the picture of a VCR or computer is being projected.

Example: When conducting presentations using a combination of slides and moving pictures from a VCR, etc., it is possible to switch from a Viewer slide to the video picture then back to the Viewer slide simply by using the Viewer button.

---

**NOTE:** Even if you switch the current Viewer source to another source, the current slide is retained. When you return back to the Viewer, you will get the slide that has been retained.

---

## Viewing Digital Images

Digital images can be played with the Viewer if the following conditions are met:

- If the image can be stored on an MS-DOS format PC card.
- If the image can be stored in a format supported by the Viewer. With the Viewer, images on the card are searched for in directories and images in JPEG or BMP format are recognized as slides. Searchable directories are directories within two steps from the root directory, and searchable images are images within the first 12 files in the directory. Only file and slide switching are possible.

---

**NOTE:** The maximum number of images recognized as slides within one directory is 128.

---

## Storing Images Displayed on the Projector on the PC card (Capture)

The Capture features allows you to capture an image from a source that is currently being displayed. The image is saved as JPEG in the PC card.

---

**NOTE:**

- \* Signals from DVI input are not possible to be captured.
  - \* Unless a PC card is inserted into the PC Card slot of the projector, the Capture feature is not available.
  - \* The "Card Error" display means that the free space of the PC card is insufficient for saving images. Make more space available on the card by erasing unwanted images with your PC. The number of images that can be captured depends on the size of the PC card.
  - \* Be sure not to turn off the power or remove the PC card while capturing an image. Doing so could cause a loss of the data in the PC card or damage to the card itself.
- 

### Preparations:

Insert the PC card into the PC card slot of the projector.

Insert the PC card so that the end with the insertion direction arrow on the top goes in first.

- \* Press the eject button to eject the card.

1. Project the image you wish to store on the projector.
2. Press the FREEZE button on the remote control.
3. Press the MENU button to display the Capture window.

Capture ..... Captures an image and saves it as a JPEG file in a PC card.

Exit ..... Exits the Capture function. Another option to exit the Capture function is to press MENU or CANCEL button on the remote control or projector cabinet.

---

**NOTE:**

Captured images with higher resolution than the projector's native resolution cannot be displayed correctly.

- File size of the captured image varies depending on the resolution of an input signal.
  - An hourglass indicating that an image is being captured appears on the projector's display. Do not eject the PC card or turn off the projector's power while this icon is displayed. Doing so will damage the PC card data. If the PC card data is damaged, use a computer to repair the data.
-



## Deleting Captured Images

Using the Delete command on the Viewer menu allows you to delete captured images.

### To delete captured images:

Preparation: Make sure that the PC card is inserted into the PC card slot of the projector.

1. Press the VIEWER button on the remote control to display an image.
2. Press the MENU button to display the Viewer menu.

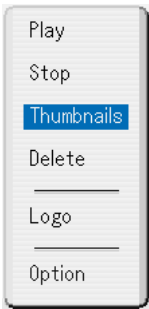

3. Use the ▼ button to select "Thumbnails" and then press the ENTER button. The Thumbnail screen will be displayed.

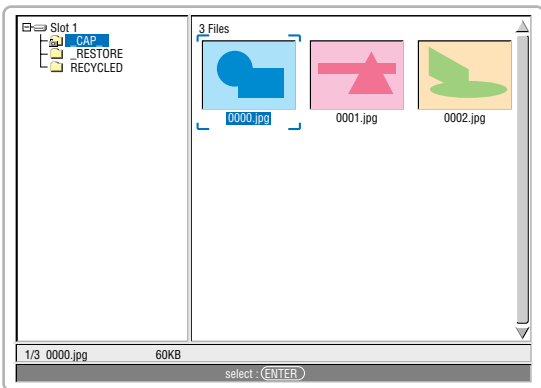

**NOTE:** To change highlight from the Thumbnails screen (right window) to a directory tree (left window), press the CANCEL button. To return highlight to the Thumbnails screen, press the ENTER button.

4. Use the ▲▼◀▶ buttons to select an image you wish to delete.
5. Press the MENU button to display the Viewer menu.
6. Use the ▼ button to select "Delete" and then press the ENTER button.

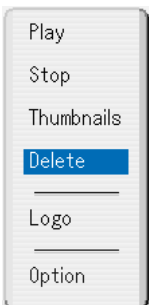

A confirmation message will be displayed.

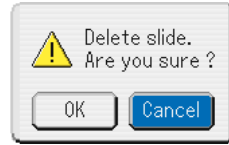

7. Use the ◀ button to select "OK" and then press the ENTER button.

This completes deleting.

### To delete all the captured images:

1. Repeat steps 1 to 3 in the above described procedure.
2. Press the CANCEL button to select the "\_CAP\_" folder in the directory (left window).

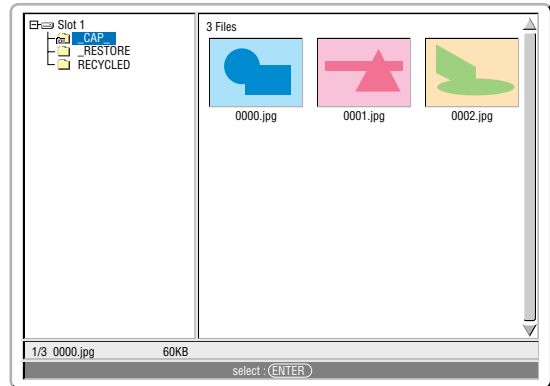

3. Press the MENU button to display the Viewer menu.
4. Use the ▼ button to select "Delete" and then press the ENTER button.

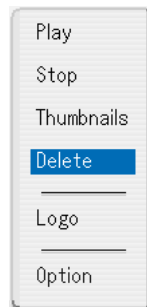

A confirmation message will be displayed.

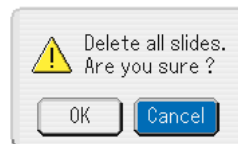

5. Use the ◀ button to select "OK" and then press the ENTER button.

This completes deleting.

## Changing Background Logo

You can change the default background logo using the Viewer feature.

**NOTE:** File size must be 256KB or less. Other file formats than JPEG and BMP are not available.

Preparation: Use the Capture feature to store JPEG or BMP files in a PC card inserted into the projector's slot. Or store JPEG or BMP files in a PC card inserted into your PC's slot and insert the PC card into the projector's slot.

1. Press the VIEWER button on the remote control to display an image.
2. Press the MENU button to display the Viewer menu.

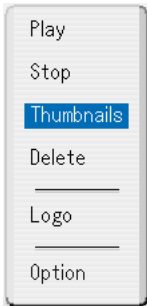

3. Use the ▼ button to select "Thumbnails" and then press the ENTER button. The Thumbnail screen will be displayed.

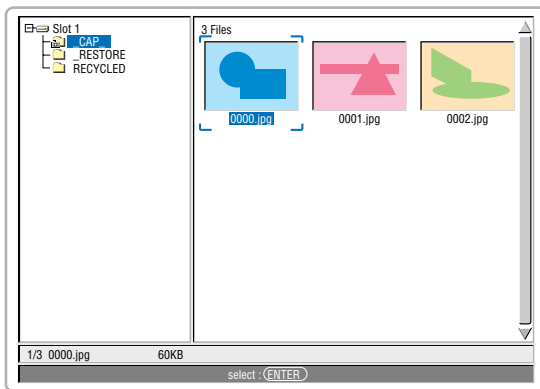

**NOTE:** To change highlight from the Thumbnails screen (right window) to a directory tree (left window), press the CANCEL button. To return highlight to the Thumbnails screen, press the ENTER button.

4. Use ▲▼◀▶ button to select a JPEG or BMP file (slide) for your background logo.
5. Press the MENU button to display the Viewer menu.

6. Use the ▼ button to select "Logo" and then press the ENTER button.

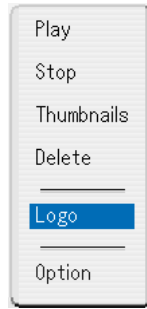

A confirmation dialog box will be displayed.

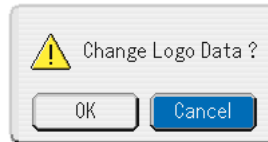

7. Use the ◀ button to select "OK" and press the ENTER button. This completes changing a logo for the background.
- \* Once you have changed the background from the NEC logo to another, you cannot return the logo to background even by using Factory Default.

# MAINTENANCE

This section describes the simple maintenance procedures you should follow to replace the lamp, and to clean the cabinet and the lens.

## Replacing the Lamp

After your lamp has been operating for 2000 hours (up to 3000 hours : Eco mode) or longer, the "Lamp" indicator in the cabinet will blink red and the message will appear. Even though the lamp may still be working, replace it at 2000 hours (up to 3000 hours : Eco mode) to maintain optimal projector performance.

### CAUTION

- **DO NOT TOUCH THE LAMP** immediately after it has been used. It will be extremely hot. Turn the projector off, wait 90 seconds, turn off the main power switch, and then disconnect the power cable. Allow at least one hour for the lamp to cool before handling.
  - **DO NOT REMOVE ANY SCREWS** except the lamp cover screw and two lamp case screws. You could receive an electric shock.
  - The projector will turn off and go into stand by mode after 2100 hours (up to 3100 hours : Eco mode) of service. If this happens, be sure to replace the lamp. If you continue to use the lamp after 2000 hours (up to 3000 hours : Eco mode) of use, the lamp bulb may shatter, and pieces of glass may be scattered in the lamp housing. Do not touch them as the pieces of glass may cause injury.
- If this happens, contact your NEC dealer for lamp replacement.

### To replace the lamp:

1. Loosen the lamp cover screw until the screwdriver goes into a free-wheeling condition and remove the lamp cover. The lamp cover screw is not removable.

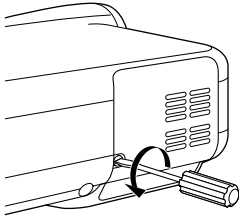

2. Loosen the two screws securing the lamp housing until the screwdriver goes into a free-wheeling condition. The two screws are not removable.

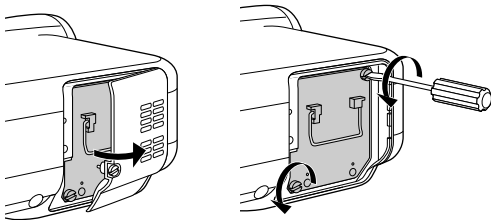

3. Remove the lamp housing by pulling out the handle.

**NOTE:** There is an interlock on this case to prevent the risk of electrical shock. Do not attempt to circumvent this interlock.

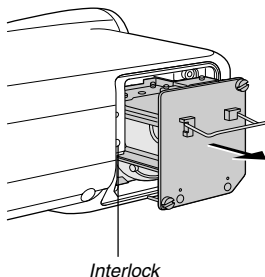

Interlock

4. Insert a new lamp housing until the lamp housing is plugged into the socket.

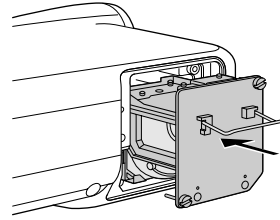

**CAUTION:** Do not use a lamp other than the NEC replacement lamp (LT60LPK).

5. Secure it in place with the two screws. Be sure to tighten the screws.

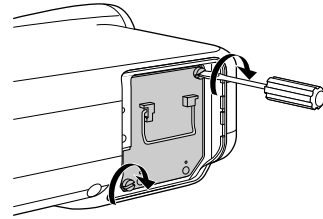

6. Reattach the lamp cover.

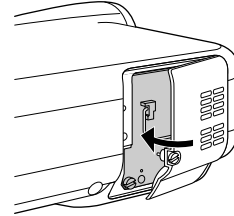

7. Tighten the lamp cover screw. Be sure to tighten the screw.

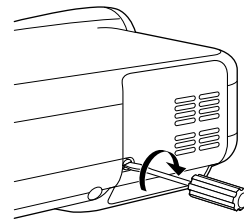

8. After you install a new lamp, from the menu select [Setup] → [Page 2] → [Lamp Hour] to reset the lamp usage hours. If the projector will not be turned on after using 2100 hours (up to 3100 hours : Eco mode) of service, press and hold the [Help] button on the remote control for ten seconds or longer to reset the lamp time clock to zero.

## Cleaning

### Cleaning the Cabinet and the Lens

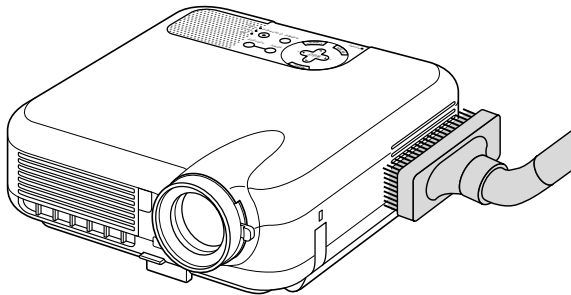

1. Turn off the projector before cleaning.
2. Clean the cabinet periodically with a damp cloth. If heavily soiled, use a mild detergent. Never use strong detergents or solvents such as alcohol or thinner.
3. Use a blower or lens paper to clean the lens, and be careful not to scratch or mar the lens.

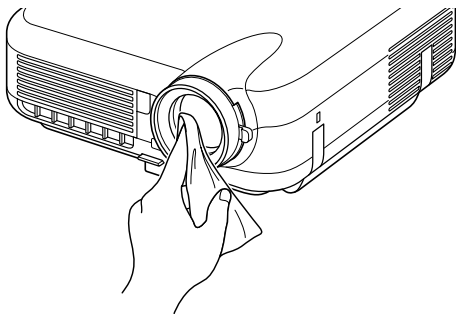

## Lens Protector

The lens barrel has threads on the outside for mounting a commercially available lens protector ( $\phi$  82mm) to protect the lens from dirt, dust, scratches and damage. Note that both a lens protector and the supplied lens cap cannot be used at the same time.

**CAUTION:** Use only transparent lens protectors designed for lens protection. Use of filters for light reduction and special effects, such as ND (Neutral Density) filters and color filters, can absorb heat, resulting in damage to the filter and the projector.

# TROUBLESHOOTING

This section helps you resolve problems you may encounter while setting up or using the projector.

## Power Indicator

Indicator Condition			Projector Condition	Note
Off			The main power is off	–
Blinking light	Green	0.5 sec On, 0.5 sec Off	The projector is getting ready to turn on.	Wait for a moment.
	Orange	0.5 sec On, 0.5 sec Off	The projector is cooling down.	Wait for a moment.
Steady light	Green		The projector is turned on.	–
	Orange		The projector is in Power-saving or Idle.	–

## Status Indicator

Indicator Condition			Projector Condition	Note
Off			Normal	–
Blinking light	Red	1 cycle (0.5 sec On, 2.5 sec Off)	Lamp cover error	Replace the lamp cover correctly.
		2 cycle (0.5 sec On, 0.5 sec Off)	Temperature error	The projector is overheated. Move the projector to a cooler location.
		3 cycle (0.5 sec On, 0.5 sec Off)	Power error	Power unit will not work correctly.
		4 cycle (0.5 sec On, 0.5 sec Off)	Fan error	Fans will not work correctly.
		6 cycle (0.5 sec On, 0.5 sec Off)	Lamp error	Lamp fails to light. Wait a full minute and then turn on again.
	Green		Re-firing the lamp	The projector is re-firing.
Steady light	Green		Idle condition	–

## Lamp Indicator

Indicator Condition			Projector Condition	Note
Off			Normal	–
Blinking light	Red		Lamp has reached its end of life. Lamp replacement message will be displayed.	Replace the lamp.
Steady light	Red		Lamp has been used beyond its limit. The projector will not turn on until the lamp is replaced.	Replace the lamp.
	Green		Lamp mode is set to Eco mode	–

**Common Problems & Solutions** (See also "Power/Status/Lamp Indicator" on page E-45.)

Problem	Check These Items
Does not turn on	<ul style="list-style-type: none"> <li>• Check that the power cable is plugged in and that the power button on the projector cabinet or the remote control is on. See pages E-17 and 18.</li> <li>• Ensure that the lamp cover is installed correctly. See page E-43.</li> <li>• Check to see if the projector has overheated or the lamp usage exceeds 2100 hours (up to 3100 hours : Eco mode). If there is insufficient ventilation around the projector or if the room where you're presenting is particularly warm, move the projector to a cooler location.</li> <li>• The lamp may fail to light. Wait a full minute and then turn on the power again.</li> <li>• The lamp has reached the end of its usable life. Replace the lamp.</li> </ul>
No picture	<ul style="list-style-type: none"> <li>• Use the SOURCE button on the projector cabinet or the VIDEO, the S-VIDEO, the COMP.V (COMPONENT), the COMP. (COMPUTER), the DVI or the VIEWER button on the remote control to select your source (Video, S-Video, Component, Computer, DVI (DIGITAL) or Viewer). See page E-19.</li> <li>• Ensure your cables are connected properly.</li> <li>• Use menus to adjust the brightness and contrast. See page E-29.</li> <li>• Remove the lens cap.</li> <li>• Reset the settings or adjustments to factory preset levels using the Reset in the Menu. See page E-37.</li> </ul> <p>When using with a notebook PC, be sure to connect between the projector and the notebook PC before turning on the power to the notebook PC. In most cases signal cannot be output from RGB output unless the notebook PC is turned on after connecting with the projector.</p> <ul style="list-style-type: none"> <li>* If the screen goes blank while using your remote control, it may be the result of the computer's screen-saver or power management software.</li> <li>* If you accidentally hit the POWER button on the remote control, wait 90 seconds and then press the POWER button again to resume.</li> </ul>
Image isn't square to the screen	<ul style="list-style-type: none"> <li>• Reposition the projector to improve its angle to the screen. See page E-19.</li> <li>• Use the 3DReform function to correct the trapezoid distortion. See page E-20.</li> </ul>
Picture is blurred	<ul style="list-style-type: none"> <li>• Adjust the focus. See page E-20.</li> <li>• Reposition the projector to improve its angle to the screen. See page E-19.</li> <li>• Ensure that the distance between the projector and screen is within the adjustment range of the lens. See page E-12.</li> <li>• Condensation may form on the lens if the projector is cold, brought into a warm place and is then turned on. Should this happen, let the projector stand until there is no condensation on the lens.</li> </ul>
Image is scrolling vertically, horizontally or both	<ul style="list-style-type: none"> <li>• Use the SOURCE button on the projector cabinet or the VIDEO, the S-VIDEO, the COMP.V (COMPONENT), the COMP. (COMPUTER), the DVI or the VIEWER button on the remote control to select your source (Video, S-Video, Component, Computer, DVI (DIGITAL) or Viewer). See page E-19.</li> <li>• Adjust the computer image manually with the Position/Clock in the Image. See page E-32.</li> </ul>
Remote control does not work	<ul style="list-style-type: none"> <li>• Install new batteries. See page E-10.</li> <li>• Make sure there are no obstacles between you and the projector.</li> <li>• Stand within 22 feet (7 m) of the projector. See page E-10.</li> </ul>
Indicator is lit or blinking	<ul style="list-style-type: none"> <li>• See the Status Indicator on page E-45.</li> </ul>
Cross color in RGB mode	<ul style="list-style-type: none"> <li>• Press the AUTO ADJUST button on the projector cabinet or the AUTO ADJ. button on the remote control.</li> <li>• Adjust the computer image manually with the Position/Clock in the Image. See page E-32.</li> </ul>

For more information contact your dealer.

**What is HDCP/HDCP technology?**

HDCP is an acronym for High-bandwidth Digital Content Protection. High bandwidth Digital Content Protection (HDCP) is a system for preventing illegal copying of video data sent over a Digital Visual Interface (DVI).

If you are unable to view material via the DVI input, this does not necessarily mean the projector is not functioning properly. With the implementation of HDCP, there may be cases in which certain content is protected with HDCP and might not be displayed due to the decision/intention of the HDCP community (Digital Content Protection, LLC).

# SPECIFICATIONS

This section provides technical information about the HT1100 Projector's performance

<b>Model Number</b>	<b>HT1100</b>
<b>Optical</b>	
DMD	Single Chip Digital Micromirror Device (DMD)
Resolution	1024×768 pixels up to 1080p (1920×1080) with Advanced AccuBlend
Lens	Manual zoom and auto focus: F2.5 – 2.7 f = 22.2mm – 26.7mm
Lamp	220 W DC standard
Image Size	30" – 200" (0.8 m – 5.08 m) diagonal (4:3) (16:9)
Projection Distance	2.95ft – 24.93ft / 0.9m – 7.6m
Projection Angle	18.6° – 19.4°(wide) / 15.7° – 16.2°(tele)
<b>Electrical</b>	
Inputs	1 RGB, 1 S-Video, 1 Video, 1 Component, 1 DVI digital, 1 PC Card, 4 Stereo Mini Audio, 1 PC Control
Outputs	1 SC.Trigger
Video Compatibility	NTSC, NTSC4.43, PAL, PAL-60, PAL-N, PAL-M, SECAM, Component: 1080p, 1080i, 720p, 576p, 480p, 576i, 480i
Scan Rate	Horizontal: 15 kHz to 100 kHz (RGB: 24 kHz or over) / Vertical: 48 Hz to 100 Hz
Video Bandwidth	RGB: 100 MHz (-3dB)
Pixel Clock Freq	Less than 160 MHz
Color Reproduction	16.7 million colors simultaneously, Full color
Horizontal Resolution	NTSC / NTSC4.43/PAL / YCbCr: 540 TV lines SECAM: 300 TV lines RGB: 1024 dots (H) × 768 dots (V),
External Control	RS232C, IR, LAN (wired)
Sync Compatibility	Separate Sync / Composite Sync / Sync on G
Built-in Speakers	2W × 2 (stereo)
Power Requirement	100 – 120V AC / 200 – 240V AC, 50 / 60 Hz
Input Current	3.2A (100 – 120V AC) / 1.6A (200 – 240V AC)
Power Consumption	290W (0.6W Standby)
<b>Mechanical</b>	
Installation	Orientation: Desktop/Front, Desktop/Rear, Ceiling/Front, Ceiling/Rear
Dimensions	10.2" (W) × 3.6" (H) × 10.8" (D) 260mm (W) × 92mm (H) × 275mm (D) (not including protrusions)
Net Weight	7.1 lbs / 3.2 kg
Environmental Considerations	
Operational Temperatures :	41°F to 95°F (5°C to 35°C), 20% to 80% humidity (non-condensing)
Storage Temperatures :	14°F to 122°F (-10°C to 50°C), 20% to 80% humidity (non-condensing)
Regulations	
	UL Approved (UL 1950, CSA 950) Meets DOC Canada Class B requirements Meets FCC Class B requirements Meets AS/NZS Cispr. 22: 2002 Class B Meets EMC Directive (EN55022, EN55024, EN61000-3-2, EN61000-3-3) Meets Low Voltage Directive (EN60950, TUV GS Approved) NOM Approved (NOM-001-SCFI-1993)
	CE

\* Effective pixels are more than 99.99%.

For additional information visit:

US : <http://www.necvisualsystems.com>

Europe : <http://www.nec-europe.com/>

Global : <http://www.nec-pj.com/>

The specifications are subject to change without notice.

# APPENDIX

## Cabinet Dimensions

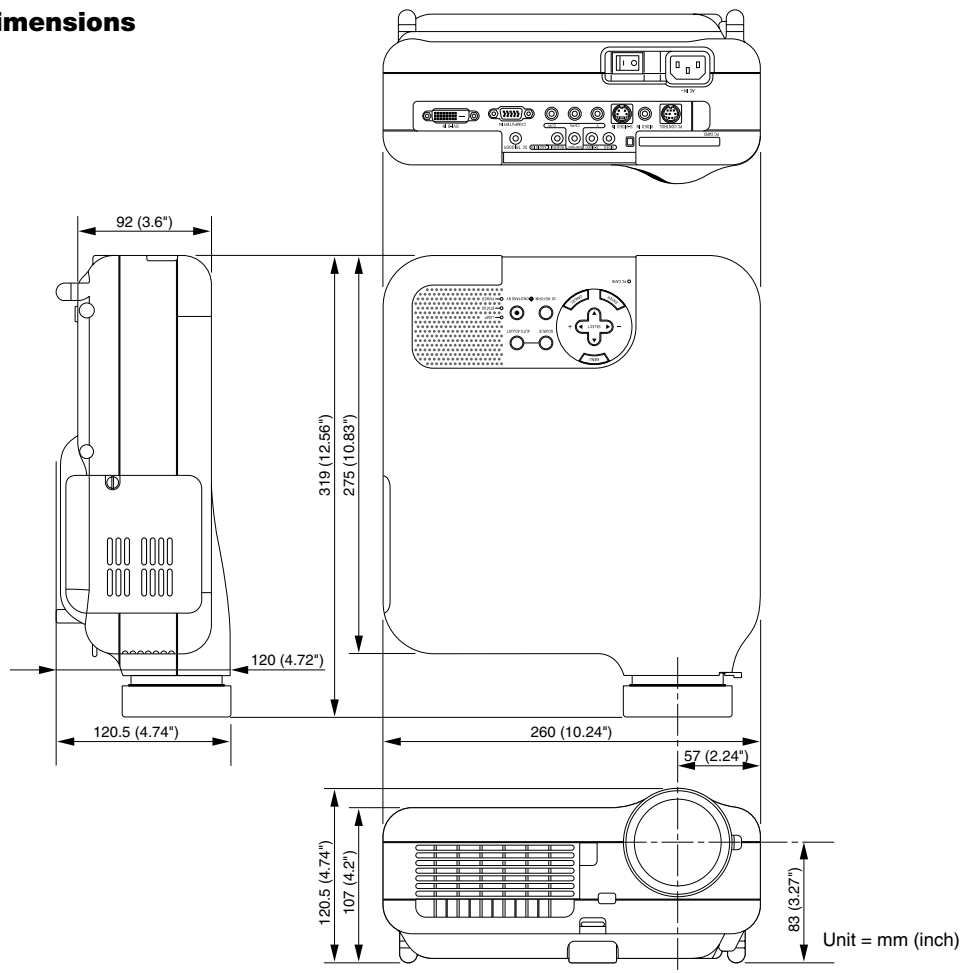

## Pin Assignments of D-Sub COMPUTER Input Connector

### Mini D-Sub 15 Pin Connector

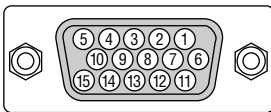

Signal Level  
 Video signal : 0.7Vp-p (Analog)  
 Sync signal : TTL level

Pin No.	RGB Signal (Analog)	YCbCr Signal
1	Red	Cr
2	Green or Sync on Green	Y
3	Blue	Cb
4	Ground	
5	Ground	
6	Red Ground	Cr Ground
7	Green Ground	Y Ground
8	Blue Ground	Cb Ground
9	No Connection	
10	Sync Signal Ground	
11	SCART Sync	
12	Bi-directional DATA (SDA)	
13	Horizontal Sync or Composite Sync	
14	Vertical Sync	
15	Data Clock	



## Compatible Input Signal List

Y/N	Signal Program	Resolution ( Dots )	Frequency H. ( kHz )	Refresh Rate ( Hz )
*2Y	NTSC	–	15.73	59.94
*2Y	PAL	–	15.63	50.00
*2Y	PAL60	–	15.73	60.00
*2Y	SECAM	–	15.63	50.00
Y	VESA	640 × 480	31.47	59.94
Y	MAC	640 × 480	35.00	66.67
Y	VESA	640 × 480	37.86	72.81
Y	VESA	640 × 480	37.50	75.00
Y	VESA	640 × 480	43.27	85.01
Y	IBM	720 × 350	31.47	70.08
Y	IBM	720 × 350	39.44	87.85
Y	IBM	720 × 400	39.44	87.85
Y	VESA	800 × 600	35.16	56.25
Y	VESA	800 × 600	37.88	60.32
Y	VESA	800 × 600	48.08	72.19
Y	VESA	800 × 600	46.88	75.00
Y	VESA	800 × 600	53.67	85.06
Y	MAC	832 × 624	49.72	74.55
Y	VESA	1024 × 768	35.52	43.48 Interlaced
Y	VESA	1024 × 768	48.36	60.00
Y	VESA	1024 × 768	56.48	70.07
Y	MAC	1024 × 768	60.24	74.93
Y	VESA	1024 × 768	60.02	75.03
Y	VESA	1024 × 768	68.68	85.00
*1*2Y	VESA	1152 × 864	67.50	75.00
*1*2Y	MAC	1152 × 870	68.68	75.06
*1*2Y	VESA	1280 × 960	60.00	60.00
*1*2Y	VESA	1280 × 1024	63.98	60.02
*1*2Y	MAC	1280 × 1024	69.87	65.18
*1*2Y	VESA	1280 × 1024	79.98	75.02
*1*2Y	VESA	1280 × 1024	91.15	85.02
*1*2Y	HDTV (1080p/60)	1920 × 1080	67.50	60.00 progressive
*1*3Y	HDTV (1080i/60)	1920 × 1080	33.75	60.00 Interlaced
*1*3Y	HDTV (1080i/50)	1920 × 1080	28.13	50.00 Interlaced
*1*3Y	HDTV (720p)	1280 × 720	45.00	60.00 Progressive
*3Y	SDTV (480p)	–	31.47	59.94 Progressive
*2 Y	DVD YCbCr	–	15.73	59.94 Interlaced
*2 Y	DVD YCbCr	–	15.63	50.00 Interlaced
*4Y	DVD progressive	–	31.47	59.94 progressive
*4Y	DVD progressive	–	31.25	50.00 progressive

\*1 : Images in above flagged with \*1 are compressed with Advanced AccuBlend.

\*2 : Images in above flagged with \*2 are not supported for the DVI-digital signals.

\*3 : Displayed only when "16:9" is selected in "Screen Type" on the DVI input.

\*4 : Displayed either when "4:3" or "16:9" is selected in "Screen Type" on the DVI input.

The other signals than \*2, \*3 and \*4 can be displayed when "4:3" is selected in "Screen Type".

**NOTE:** Some composite sync signals may not be displayed correctly.

Signals other than those specified in the table above may not be displayed correctly. If this should happen, change the refresh rate or resolution on your PC. Refer to Display Properties help section of your PC for procedures.

## PC Control Codes and Cable Connection

### PC Control Codes

Function	Code Data
POWER ON	02H 00H 00H 00H 00H 02H
POWER OFF	02H 01H 00H 00H 00H 03H
INPUT SELECT COMPUTER	02H 03H 00H 00H 02H 01H 01H 09H
INPUT SELECT COMPONENT	02H 03H 00H 00H 02H 01H 10H 18H
INPUT SELECT VIDEO	02H 03H 00H 00H 02H 01H 06H 0EH
INPUT SELECT S-VIDEO	02H 03H 00H 00H 02H 01H 08H 13H
INPUT SELECT DVI (DIGITAL)	02H 03H 00H 00H 02H 01H 1AH 22H
INPUT SELECT VIEWER	02H 03H 00H 00H 02H 01H 1FH 27H
PICTURE MUTE ON	02H 10H 00H 00H 00H 12H
PICTURE MUTE OFF	02H 11H 00H 00H 00H 13H
SOUND MUTE ON	02H 12H 00H 00H 00H 14H
SOUND MUTE OFF	02H 13H 00H 00H 00H 15H
ON SCREEN MUTE ON	02H 14H 00H 00H 00H 16H
ON SCREEN MUTE OFF	02H 15H 00H 00H 00H 17H

**NOTE:** Contact your local dealer for a full list of PC Control Codes if needed.

### Cable Connection

Communication Protocol

Baud rate	38400 bps
Data length	8 bits
Parity	No parity
Stop bit	One bit
X on/off	None
Communications procedure	Full duplex

**NOTE:** Depending on the equipment, a lower baud rate may be recommended for long cable runs.

### PC Control Connector (DIN-8P)

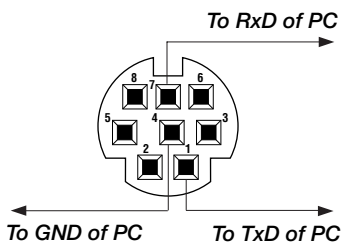

**NOTE:** Pins 2, 3, 5, 6 and 8 are used inside the projector.

## Using Software Keyboard



1 to 0 and Characters

- ..... Use to type in IP address or projector name
- SP ..... Inserts a space
- BS ..... Deletes one character backward
- ◀ ..... Returns to the previous
- ▶ ..... Advances to the next
- OK ..... Executes the selection
- Cancel ..... Cancels the selection
- MODE ..... Selects one of three modes for alphabet and special characters.

# Operation Using an HTTP Browser

## Overview

The use of HTTP server functions will allow control of the projector from a web browser without the installation of special software. Please be sure to use "Microsoft Internet Explorer 4.x" or a higher version for the web browser. (This device uses "JavaScript" and "Cookies" and the browser should be set to accept these functions. The setting method will vary depending on the version of browser. Please refer to the help files and the other information provided in your software.)

### NOTE:

- \* The use of HTTP server functions is not available during Standby mode.
- \* The display's or button's response can be slowed down or operation may not be accepted depending the settings of your network. Should this happen, consult your network administrator.
- \* The projector may not respond if its buttons are repeatedly pressed in rapid intervals. Should this happen, wait a moment and repeat. If you still can't get any response, pull out and then re-insert the LAN card.

Access is gained to the HTTP server functions by specifying `http://<the projector's IP address>/index.html` in the entry column of the URL.

## Preparation Before Use

Make network connections and set up the projector and confirm that it is complete before engaging in browser operations. (See "Setting LAN Mode" on page E-34.)

Operation with a browser that uses a proxy server may not be possible depending on the type of proxy server and the setting method. Although the type of proxy server will be a factor, it is possible that items that have actually been set will not be displayed depending on the effectiveness of the cache, and the contents set from the browser may not be reflected in operation. It is recommended that a proxy server not be used unless it is unavoidable.

## Handling of the Address for Operation via a Browser

Regarding the actual address that is entered for the address or entered to the URL column when operation of the projector is via a browser, the host name can be used as it is when the host name corresponding to the IP address of the projector has been registered to the domain name server by a network administrator, or the host name corresponding to the IP address of the projector has been set in the "HOSTS" file of the computer being used.

**Example 1:** When the host name of the projector has been set to "pj.nec.co.jp", `http://pj.nec.co.jp/index.html` is specified for the address or the entry column of the URL.

**Example 2:** When the IP address of the projector is "192.168.73.1", access is gained to the HTTP server functions by specifying `http://192.168.73.1/index.html` for the address or the entry column of the URL.

## Structure of the HTTP Server

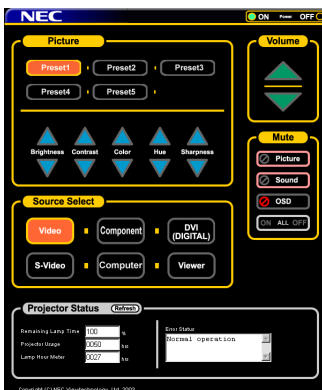

**Power:** This controls the power of the projector.

- On ..... Power is switched on.
- Off ..... Power is switched off.

**Volume:** This controls the volume of the projector.

- ▲ ..... Increments the volume adjustment value.
- ▼ ..... Decrements the volume adjustment value.

**Mute:** This controls the mute function of the projector.

- Picture On ..... Mutes the video.
- Picture Off ..... Cancels the video muting.
- Sound On ..... Mutes the audio.
- Sound Off ..... Cancels the audio muting.
- OSD On ..... Mutes the on-screen display.
- OSD Off ..... Cancels the muting of the on-screen display.
- All On ..... Mutes each of the video, audio, and on-screen display functions.
- All Off ..... Cancels the muting of each of the video, audio, and on-screen display functions.

**Picture:** Controls the video adjustment of the projector.

- Preset 1-5
- Brightness ▲ .. Increments the brightness adjustment value.
- Brightness ▼ .. Decrements the brightness adjustment value.
- Contrast ▲ ..... Increments the contrast adjustment value.
- Contrast ▼ ..... Decrements the contrast adjustment value.
- Color ▲ ..... Increments the color adjustment value.
- Color ▼ ..... Decrements the color adjustment value.
- Hue ▲ ..... Increments the hue adjustment value.
- Hue ▼ ..... Decrements the hue adjustment value.
- Sharpness ▲ . Increments the sharpness adjustment value.
- Sharpness ▼ . Decrements the sharpness adjustment value.

\* The functions that can be controlled will vary depending on the signal being input to the projector.

**Source Select:** This switches the input connector of the projector.

- Video ..... Switches to the Video connector.
- S-Video ..... Switches to the S-Video connector.
- Component .... Switches to the Component connectors.
- Computer ..... Switches to the Computer connector.
- DVI (DIGITAL) Switches to the DVI-D connector.
- Viewer ..... Switches to the Viewer.

**Projector Status:** This displays the condition of the projector.

- Refresh ..... Updates the display of the following conditions.
- Remaining Lamp Time .. Displays the remaining life of the lamp as a percentage.
- Projector Usage ..... Displays how many hours the projector has been used.
- Lamp Hour Meter ..... Displays how many hours the lamp has been used.
- Error Status ..... Displays the status of errors occurring within the projector.

# TravelCare Guide

## TravelCare - a service for international travelers

This product is eligible for "TravelCare", NEC's unique international warranty.

Please note that TravelCare coverage differs in part from coverage under the warranty included with the product.

## Services offered with TravelCare

This warranty allows customers to receive service on their product at the NEC and NEC-designated service stations in the countries listed herein when temporarily traveling internationally for business or pleasure.

For details on services offered by the different service stations, please refer to the "List of TravelCare Outlets" below.

### 1 Repair services

The product will be repaired and delivered within 10 business days, not including shipping time.

During the term of warranty, the cost of maintenance parts, labor costs for repairs and shipping costs within the service station's coverage area are covered by the warranty.

### 2 Replacement product rental service

If the customer desires, he or she can rent a replacement product while the original product is being repaired.

Fee: US\$200 for 12 days

This fee must be paid at the local service station in cash or credit card.

The \$200 rental fee is non-refundable even if the customer rents it less than 12 days before returning.

The replacement product will be delivered within 3 business days.

If the customer did not return the replacement product within 12 days, the customer will be charged the price of the unit.

If the customer returned the replacement product in a faulty or damaged condition, the repair cost will be charged to the customer.

Note that this service is not offered in all countries and regions. Please refer to the "List of TravelCare Outlets".

In addition, this replacement product rental service is not offered after the product's warranty has expired.

## Term of warranty

1

- a. Upon presentation of the warranty or receipt received upon purchase:

*Valid for the term indicated on the warranty or the normal term of warranty for the country of purchase.*

- b. When only the product is brought in:

*Valid for a period of within 14 months of the date of manufacture indicated by the serial number attached to the product.*

2 When a product whose term of warranty is expired is brought in:

Repairs will be offered for a fee. In this case the customer is not eligible for the replacement product rental service.

3 In the following cases, repairs may be charged, even if the product's warranty is still in effect:

- 1) If the term of warranty, model name, serial number and name of the store of purchase are not indicated on the warranty or have been altered.
- 2) Problems or damage caused by dropping or shocks during shipment or movement by the customer or by improper handling by the customers.
- 3) Problems or damage caused by improper usage or unwarrantable alterations or repairs by the customer.
- 4) Problems or damage caused by fire, salt damage, gas damage, earthquakes, lightning damage, storm or flood damage or other natural disasters or such external factors as dust, cigarette smoke, abnormal voltage, etc.
- 5) Problems or damage caused by use in hot or humid places, in vehicles, boats or ships, etc.

- 6) Problems or damage caused by expendable supplies or devices connected to the product other than those designated by NEC.

- 7) Problems caused by natural consumption, wear or deterioration of parts under normal usage conditions.

- 8) Problems or damage to lamps and other expendable supplies, included parts or optional parts.

- 9) Other conditions stipulated in the warranty included with the product also apply.

**NOTE:** The product can be used overseas with voltages of 100 to 120V and 200 to 240V by using a power cable suited for the standards and power source voltage of the country in which the product is being used.

## List of TravelCare Outlets

This list applies as of June 1, 2002.

For the most up-to-date information, please refer to the websites of the service stations in the various countries on the List of TravelCare Outlets or to the NEC website at <http://www.nec-pj.com>.

### In Europe

NEC Europe, Ltd. / European Technical Centre

Address: Unit G, Stafford Park 12, Telford TF3 3BJ, U.K.

Telephone: +44 1952 237000

Fax Line: +44 1952 237006

Email Address: [AFR@uk.necur.com](mailto:AFR@uk.necur.com)

WEB Address: <http://www.necur.com>

(Regions Covered)

EU: Austria\*, Belgium\*, Denmark\*, Finland\*, France\*, Germany\*, Greece\*, Ireland\*, Italy\*, Luxembourg\*, The Netherlands\*, Portugal\*, Spain\*, Sweden\* and the United Kingdom\*

EEA: Norway\*, Iceland and Liechtenstein

### In North America

NEC Solutions (America), Inc.

Address: 1250 Arlington Heights Road, Itasca, Illinois 60143, U.S.A.

Telephone: +1 800 836 0655

Fax Line: +1 800 356 2415

Email Address: [vsd-tech-support@necsam.com](mailto:vsd-tech-support@necsam.com)

WEB Address: <http://www.necvisualsystems.com>

(Regions Covered)

U.S.A. \*, Canada\*

### In Oceania

NEC Australia Pty., Ltd.

Address: New South Wales;

184 Milperra Road, Reversby 2212

Victoria;

480 Princess Hwy Noble Park 3174

South Australia;

84A Richmond Road, Keswick 5035

Queensland;

116 Ipswich Road, Woollongabba 4102

Western Australia;

45 Sarich Court Osborne Park 6017

Telephone: 131 632 (from domestic)

+61 8 8375 5706 (from overseas)

Fax Line: +61 8 8375 5757

Email Address: [lee.gramola@nec.com.au](mailto:lee.gramola@nec.com.au)

WEB Address: <http://www.nec.com.au>

(Regions Covered)

Australia\*, New Zealand

**In Asia and Middle East****NEC Viewtechnology, Ltd.**

Address: 686-1, Nishioi, Oi-Machi, Ashigarakami-Gun,  
Kanagawa 258-0017, Japan  
Telephone: +81 465 85 2369  
Fax Line: +81 465 85 2393  
Email Address: support\_pjweb@nevt.nec.co.jp  
WEB Address: http://www.nec-pj.com

(Regions Covered)  
Japan\*

**NEC Hong Kong Ltd.**

Address: 11th Floor, Tower B, New Mandarin Plaza, 14  
Science Museum Road,  
Tsim Sha Tsui East, Kowloon, Hong Kong  
Telephone: +852 2369 0335  
Fax Line: +852 2795 6618  
Email Address: esmond\_au@nechk.nec.com.hk  
WEB Address: http://www.nec.com.hk

(Regions Covered)  
Hong Kong

**NEC Taiwan Ltd.**

Address: 7F, No.167, SEC.2, Nan King East Road, Taipei,  
Taiwan, R.O.C.  
Telephone: +886 2 8500 1734  
Fax Line: +886 2 8500 1420  
Email Address: nickliao@nec.com.tw  
WEB Address: http://www.nec.com.tw

(Regions Covered)  
Taiwan

**NEC Solutions Asia Pacific Pte. Ltd**

Address: 401 Commonwealth Drive, #07-02, Haw Par  
Technocentre, Singapore 149598  
Telephone: +65 6 273 8333  
Fax Line: +65 6 274 2226  
Email Address: tehgh@rsc.ap.nec.com.sg  
WEB Address: http://www.nec.com.sg/ap

(Regions Covered)  
Singapore

**Nautilus Hyosung Inc.**

Address: 7th Floor, Cheongdam Building, 52,  
Cheongdam-Dong,  
Kangnam-Ku, Seoul, Korea 135-100  
Telephone: +82 2 510 0234  
Fax Line: +82 2 540 3584  
Email Address: hds-ykc@hyosung.com

(Regions Covered)  
South Korea

**Lenso Communication Co., Ltd.**

Address: 292 Lenso House 4, 1st Floor, Srinakarin Road,  
Huamark, Bangkok, Bangkok 10240, Thailand  
Telephone: +66 2 375 2425  
Fax Line: +66 2 375 2434  
Email Address: pattara@lenso.com  
WEB Address: http://www.lenso.com

(Regions Covered)  
Thailand

**ABBA Electronics L.L.C.**

Address: Tariq Bin Ziyad Road, P.O.Box 327, Dubai,  
United Arab Emirates  
Telephone: +971 4 371800  
Fax Line: +971 4 364283  
Email Address: ABBA@emirates.net.ae

(Regions Covered)  
United Arab Emirates

**Samir Photographic Supplies**

Address: P.O.Box 599, Jeddah 21421, Saudi Arabia  
Telephone: +966 2 6828219  
Fax Line: +966 2 6830820  
Email Address: vartkes@samir-photo.com

(Regions Covered)  
Saudi Arabia

---

**NOTE:** In countries designated with an asterisk(\*), replacement product rental service are offered.

---

Date: / / ,

P-1/ ,

**TO: NEC or NEC's Authorized Service Station:**

**FM:**

\_\_\_\_\_  
(Company & Name with signature)

Dear Sir (s),

I would like to apply your TravelCare Service Program based on attached registration and qualification sheet and agree with your following conditions, and also the Service fee will be charged to my credit card account, if I don't return the Loan units within the specified period. I also confirm following information is correct. Regards.

***Application Sheet for TravelCare Service Program***

Country, product purchased :	
User's Company Name :	
User's Company Address : Phone No., Fax No. :	
User's Name :	
User's Address :	
Phone No., Fax No. :	
Local Contact office :	
Local Contact office Address :	
Phone No., Fax No. :	
User's Model Name :	
Date of Purchase :	
Serial No. on cabinet :	
Problem of units per User :	
Required Service :	(1) Repair and Return      (2) Loan unit
Requested period of Loan unit :	
Payment method :	(1) Credit Card      (2) Travelers Cheque      (3) Cash
In Case of Credit Card : Card No. w/Valid Date :	

## Condition of your TravelCare Service Program

Enduser is requested to understand following conditions of TravelCare Service Program and complete the necessary information on the application sheet.

### 1. Service Options:

There are 3 types of "Service" available. Enduser has to understand following condition and is required to fill in the Application Sheet.

#### 1) Repair and Return:

The 'Faulty unit' is sent or collected from the customer. It is repaired and returned within 10 days to the customer, excluding transport time.

There might be the case where repair and return cannot be done by NEC Authorized Service Station, because of shortage of spare parts due to same model is not sold in the territory.

#### 2) Repair and Return with Loan: (This service is limited to some Service Stations)

This service is offered to the Enduser, who cannot wait until their unit is repaired.

The customer can borrow a unit for \$200 up to 12 days and then sends in the inoperable unit to the nearest NEC Authorized Service Station for service. In order to prevent a collection problem, Enduser is required to fill in Application Sheet.

The Enduser needs to confirm the availability of the Service to NEC Authorized Service Stations.

#### 3) Loan Only:

For this service, NEC Authorized Service Station supplies the customer with a loan unit for US\$200 up to 12 days. The customer keeps the inoperable unit and needs to arrange to have the projector serviced in the home country, by return.

## 2. Warranty Exclusions:

This program does not apply if the Projector's serial number has been defaced, modified or removed.

If, in the judgement of NEC Authorized Service Station or its agent the defects or failures result from any cause other than fair wear and tear or NEC neglect, or fault including the following without limitation:

- 1) Accidents, transportation, neglect, misuse, abuse, water, dust, smoke or default of or by the Customer its employees or agents or any third party;
- 2) Failure or fluctuation of electrical power, electrical circuitry, air conditioning, humidity control or other environmental conditions, such as use in a smoking area;
- 3) Any fault in the attachments or associated products or components (whether or not supplied by NEC or its agents which do not form part of the Product covered by this warranty);
- 4) Any act of God, fire, flood, war, act of violence or any similar occurrence;
- 5) Any attempt by any person other than any person authorized by NEC to adjust, modify, repair, install or service the product.
- 6) Any Cross-border charges such as, duty, insurance, tax etc.

## 3. Charges for Warranty Exclusions and Out of Warranty Case:

In case faulty unit is under warranty exclusions case or under Out of Warranty period, NEC Authorized Service Station will Inform estimation of actual service cost to the Enduser with reason.

## 4. Dead on Arrival (DOA):

Enduser must take this issue up with their original supplier in the country of purchase.

NEC Authorized Service Station will repair the DOA unit as a Warranty repair, but will not exchange DOA unit with new units.

## 5. Loan Service Charges and Conditions:

Upon acceptance of this NEC Projector, Customer agrees to assume liability for this loan unit.

The current cost of use of this loan unit is \$200.00 USD for 12 calendar days.

If Customer does not return the unit within the 12 calendar days, Customer will be charged the next highest cost up to and including the full list price to Credit Cards, which price will be informed by NEC Authorized Service Stations. Please see the attached listing of contacts for each country to arrange for pickup of the loan unit.

If you return to their country of origin with the loan unit, you will be charged additional freight to return the unit to the loaning country.

Thank you for your understanding of this program.

## **Note on Using DVI Connector**

The projector will not display an image from a computer via a DVI cable in some cases. Should this happen, try to change the Screen Type to "4:3" using the menu.

This is because the projector's Screen Type is set to 16:9 at the factory and the computer will not display 4:3 signals such as an XGA (1024 x 768) and SVGA (800 x 600).

When using a graphics card supporting wide-screen signals such as 16:9 signals, we recommend you to change the resolution to 720p (1280 x 720).

If this does not display the 720p signal, upgrade your driver or consult the manufacturer of your graphics card.



# LIMITED WARRANTY (USA and Canada only)

## NEC SOLUTIONS' PROJECTOR PRODUCTS

NEC Solutions (America), Inc. (hereafter NEC Solutions) warrants this product to be free from defects in material and workmanship under the following terms.

## HOW LONG IS THE WARRANTY

NEC Solutions' HT1100 projector is covered by a two (2) year limited parts and labor warranty from the date of the first customer purchase. The lamp when used under normal operating conditions is warranted for 500 hours or 90 days, whichever comes first.

## WHO IS PROTECTED

This warranty may be enforced only by the first purchaser, and is not transferable.

## WHAT IS COVERED AND WHAT IS NOT COVERED

Except as specified below, this warranty covers all defects in material or workmanship in this product.

NEC SOLUTIONS' LIABILITY FOR ANY DEFECTIVE PRODUCT IS LIMITED TO THE REPAIR OR REPLACEMENT OF THE PRODUCT AT NEC SOLUTIONS' OPTION. REPLACEMENT PRODUCTS MAY BE NEW OR 'LIKE NEW'. The following are not covered by the limited warranty and NEC Solutions shall not be liable for:

1. Any product which is not distributed in the U.S.A. or Canada by NEC Solutions or which is not purchased, installed, and operated in the U.S.A or Canada.
2. Any product on which the serial number has been defaced, modified or removed.
3. Normal decrease in lamp light output over time.
4. Damage, deterioration or malfunction resulting from:
  - a. Accident, misuse, abuse, neglect, improper ventilation, fire, dust, smoke, water, lightning or other acts of nature, unauthorized product modification, or failure to follow instructions supplied with the product.
  - b. Repair or attempted repair by anyone other than a NEC Solutions authorized service center.
  - c. Any shipment of the product (claims must be presented to the carrier).
  - d. Removal or installation of the product.
  - e. Any other cause which does not relate to a product defect.
  - f. Use of the product beyond normal operating conditions. Normal operating conditions are defined as product use not in excess of 8 hours per day and 260 days per year.
5. Cartons, carrying cases, shipping cases, batteries, external cabinets, magnetic tapes, or any accessories used in connection with the product.
6. Service required as a result of third party components.

## WHAT NEC SOLUTIONS WILL PAY FOR

NEC Solutions will pay labor and material expenses for covered items, but NEC Solutions will not pay for the following:

1. Removal or installation charges.
2. Costs of technical adjustments, set-up, maintenance, or adjustment of user controls.
3. Payment of shipping and related charges incurred in returning the product for warranty repair.

## HOW YOU CAN GET WARRANTY SERVICE

1. To obtain service on your product, consult the dealer from whom you purchased the product.
2. Whenever warranty service is required, the original dated invoice (or a copy) must be presented as proof of warranty coverage. In order to obtain warranty service, you may be required to describe and demonstrate the problem to your dealer or to NEC Solutions.
3. All products returned to NEC Solutions for service MUST have prior approval. To receive approval or for the name of the nearest NEC Solutions authorized service center, call NEC Solutions at 800-836-0655.
4. It shall be your obligation and expense to ship the product, freight prepaid, or to deliver it to a NEC Solutions authorized service center, in either the original package or a similar package affording an equal degree of protection.
5. In the event a product is returned to NEC Solutions for warranty service, and it is determined that there is no product defect or that the product condition is not covered by this limited warranty, a diagnostic service fee may be charged to the customer.

## LIMITATION OF IMPLIED WARRANTIES

EXCEPT AS EXPRESSLY SET FORTH IN THIS LIMITED WARRANTY, NEC SOLUTIONS MAKES NO OTHER WARRANTIES, EXPRESS OR IMPLIED, INCLUDING BUT NOT LIMITED TO ANY IMPLIED WARRANTIES OR CONDITIONS OF MERCHANTABILITY AND FITNESS FOR A PARTICULAR PURPOSE. ANY IMPLIED WARRANTIES THAT MAY BE IMPOSED BY LAW ARE LIMITED TO THE TERMS AND DURATION OF THIS LIMITED WARRANTY.

## EXCLUSION OF DAMAGES

NEC SOLUTIONS' LIABILITY FOR ANY DEFECTIVE PRODUCT IS LIMITED TO THE REPAIR OR REPLACEMENT OF THE PRODUCT AT NEC SOLUTIONS' OPTION. NEC SOLUTIONS SHALL NOT BE LIABLE FOR:

1. DAMAGE TO OTHER PROPERTY CAUSED BY ANY DEFECTS IN THIS PRODUCT, DAMAGES BASED UPON INCONVENIENCE, LOSS OF USE OF THE PRODUCT, LOSS OF TIME, COMMERCIAL LOSS; OR
2. ANY OTHER DAMAGES, WHETHER INCIDENTAL, CONSEQUENTIAL OR OTHERWISE.

## HOW STATE LAW RELATES TO THE WARRANTY

SOME STATES DO NOT ALLOW LIMITATIONS ON HOW LONG AN IMPLIED WARRANTY LASTS AND/OR DO NOT ALLOW THE EXCLUSION OR LIMITATION OF INCIDENTAL OR CONSEQUENTIAL DAMAGES, SO THE ABOVE LIMITATIONS AND EXCLUSIONS MAY NOT APPLY TO YOU. THIS LIMITED WARRANTY GIVES YOU SPECIFIC LEGAL RIGHTS, AND YOU MAY HAVE OTHER RIGHTS WHICH VARY FROM STATE TO STATE.

## FOR MORE INFORMATION, CONTACT:

NEC SOLUTIONS (AMERICA), INC.  
1250 N. Arlington Heights Road, Suite 400  
Itasca, Illinois 60143-1248  
TELEPHONE 800-836-0655  
[www.necvisualsystems.com](http://www.necvisualsystems.com)

Customers are cautioned that product performance is affected by system configuration, software, the application, customer data, and operator control, among other factors. While NEC Solutions' products are considered to be compatible with many systems, the specific functional implementation by the customers of the product may vary. Therefore, the suitability of a product for a specific purpose or application must be determined by the customer and is not warranted by NEC Solutions.

---

---

## DECLARATION OF CONFORMITY

---

---

This device complies with Part 15 of FCC Rules. Operation is subject to the following two conditions. (1) This device may not cause harmful interference, and (2) this device must accept any interference received, including interference that may cause undesired operation.

<b>U.S. Responsible Party:</b>	<b>NEC Solutions (America), Inc.</b>
<b>Address:</b>	<b>1250 N. Arlington Heights Road Itasca, Illinois 60143</b>
<b>Tel. No.:</b>	<b>(630) 467-5000</b>

Type of Product:	Projector
Equipment Classification:	Class B Peripheral
Models:	HT1100

*We hereby declare that the equipment specified above  
conforms to the technical standards as specified in the FCC Rules.*

---

---

