



English



Declaration of Conformity

Manufacturer: InFocus Corporation, 27500 SW Parkway Ave. Wilsonville, Oregon 97070 USA

European Office: Olympia 1, NL-1213 NS Hilversum, The Netherlands

We declare under our sole responsibility that the DP6500x projector conforms to the following directives and norms:

EMC Directive 89/336/EEC, Amended by 93/68/EEC

EMC: EN 55022

EN 55024

EN 61000-3-2

EN 61000-3-3

Low Voltage Directive 73/23/EEC, Amended by 93/68/EEC

Safety: EN 60950: 2000

July, 2002

Australian Certification C-tick mark

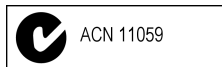

Trademarks

Apple, Macintosh, and PowerBook are trademarks or registered trademarks of Apple Computer, Inc. IBM is a trademark or registered trademark of International Business Machines, Inc. Microsoft, PowerPoint, and Windows are trademarks or registered trademarks of Microsoft Corporation. InFocus, Proxima, and ProjectorNet, are trademarks or registered trademarks of InFocus Corporation.

FCC Warning

This equipment has been tested and found to comply with the limits for a Class A digital device, pursuant to part 15 of the FCC Rules. These limits are designed to provide reasonable protection against harmful interference when the equipment is operated in a commercial environment. This equipment generates, uses, and can radiate radio frequency energy and, if not installed and used in accordance with the instruction manual, may cause harmful interference to radio communications. Operation of this equipment in a residential area is likely to cause harmful interference in which case the user will be required to correct the interference at his own expense.

This Class A digital apparatus complies with Canadian ICES-003.

Cet appareil numérique de la classe A est conforme à la norme NMB-003 du Canada.

Safety Certifications

UL, CUL, TÜV, NOM, IRAM, GOST, CCC

Remote Control Warning

Laser radiation class II product; wavelength 650nm; maximum output 1mW. Remote control complies with applicable requirements of 21 CFR 1040.10 and 1040.11.

Remote control complies with applicable requirements of EN 60 825-1: 1994 +A11.

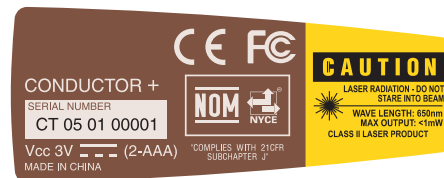



Table of Contents

Introduction	5
Connecting a computer	7
Required computer connections	7
Optional computer connections	7
Displaying a computer image	9
First-time projector use with Windows 98	10
Adjusting the image	12
Connecting a video device	13
Displaying a video image	14
Shutting down the projector	16
Troubleshooting your setup	16
Using the keypad buttons	24
Using the remote control	25
Using the audio	26
Optimizing computer images	27
Presentation features	27
Optimizing video images	28
Customizing the projector	28
Using the menus	29
Picture menu	30
Settings menu	33
Maintenance	36
Cleaning the lens	36
Replacing the projection lamp	37
Using the security lock	39
Appendix	40
Specifications	40
Accessories	40
Red LED Behavior and Projector Errors	41
Projected image size	41

 are experienced in setting up presentation systems, use the *Quick Set Up* card that was included in the carry case. For complete details on connecting and operating the projector, refer to this User's Guide.

The website also has technical specifications (an interactive image size calculator, laptop activation commands, connector pin outs, a glossary, the product data sheet), a web store to buy accessories, and a page for online registration.

Important Operating Considerations

Do not place the projector on a tablecloth or other soft covering that may block the vents. Vents are placed along the left and right sides of the DP6500x, as well as across the front of the projector. Do not use a non-approved ceiling mount. In the unlikely event of the lamp rupturing, discard any edible items placed in the surrounding area and thoroughly clean the area along the sides and in the front of the projector.

Do not place objects in the areas along the side and in the front of the projector

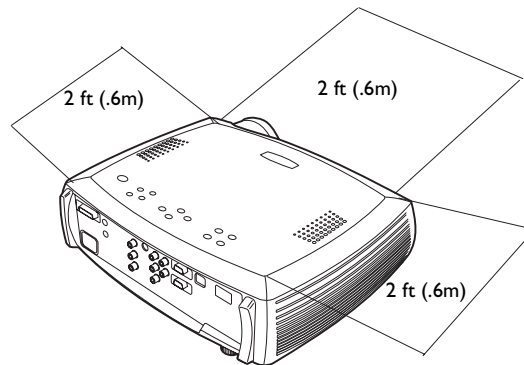

Introduction



Your new digital projector is easy to connect, easy to use, easy to maintain and has XGA 1024x768 resolution.

The projector comes in a carry case that offers ample room for Proxima accessory items such as the projector remote, color-coded cables, and documentation. The color-coded cable straps and cables they contain make your setup experience quick and easy, while the case's design helps you find and put away all items without the fear of anything becoming lost.

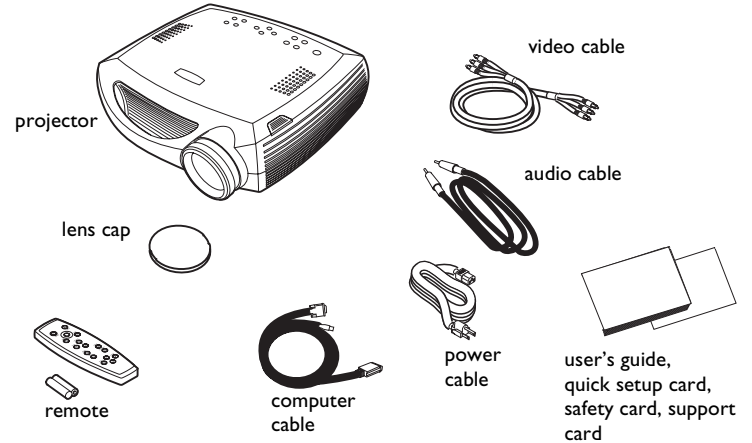
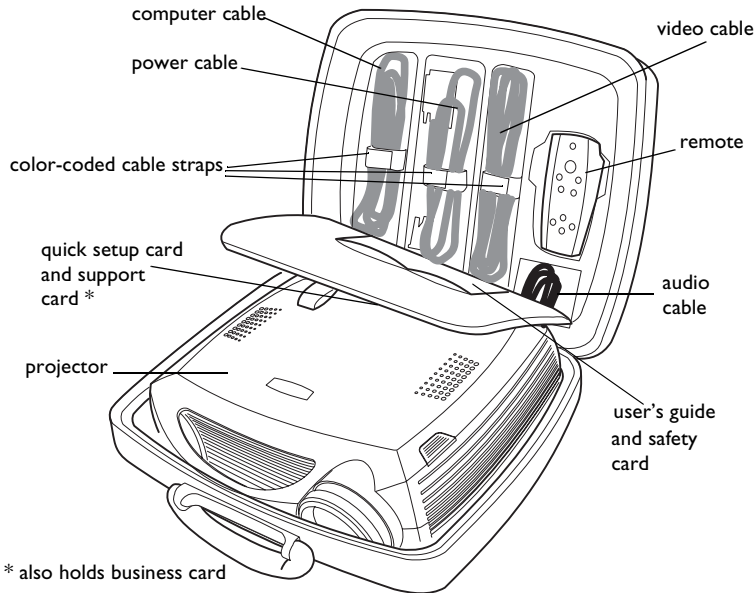

Cables

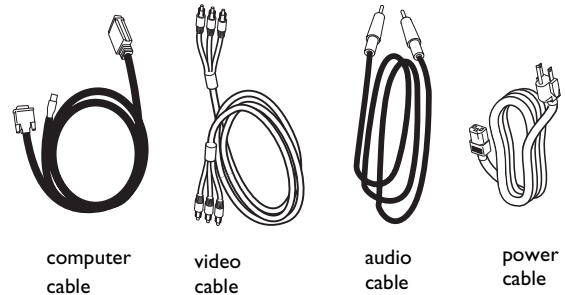

Online Registration

Register your projector online at www.infocus.com/register to receive product updates, announcements, and registration incentives.

Projector components and features

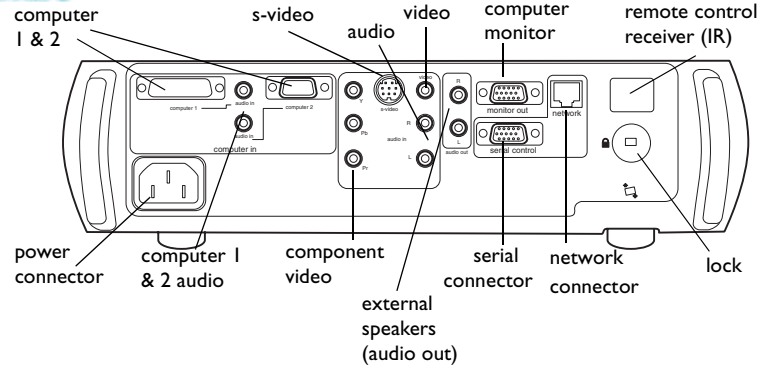
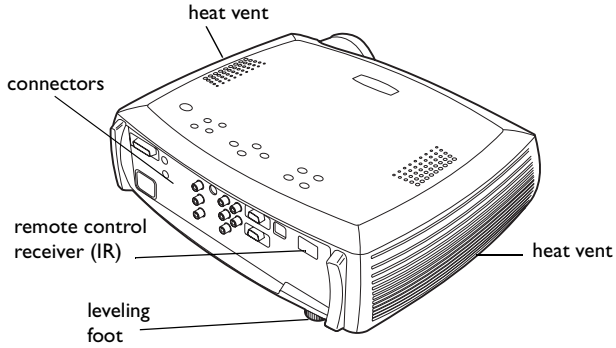
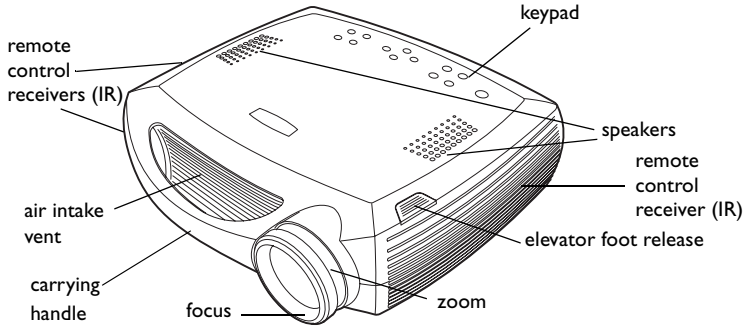

Connecting a computer



connect computer cable

Required computer connections

Connect the black end of the computer cable to the **Computer In** connector on the projector. Connect the blue end to the video port on your computer. If you are using a desktop computer, you first need to disconnect the monitor cable from the computer's video port.

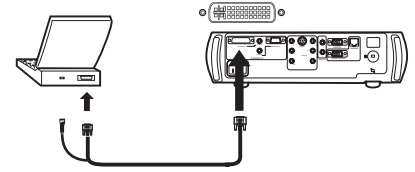

Connect the black power cable to the connector on the back of the projector and to your electrical outlet.

connect power cable

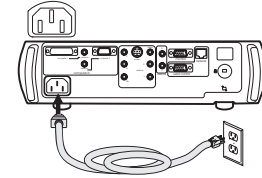

The Power LED on the projector's keypad turns solid green.

NOTE: Always use the power cable that shipped with the projector.

Optional computer connections

To control your computer's mouse using the projector's remote control, connect the USB connector on the computer cable to the computer. USB drivers must be installed to use the USB feature. For more information, see page 11.

connect computer cable

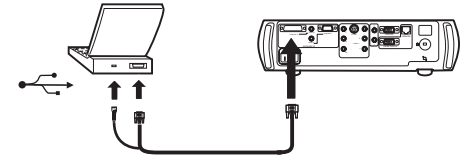

To have sound with your presentation, connect the audio cable to your computer and to the computer **Audio In** connector on the projector.

connect audio cable

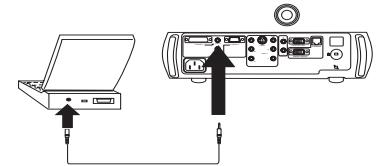

If you are using a desktop computer and want to see the image on your computer screen as well as on the projection screen, plug the monitor cable to the **Monitor out** connector on the projector.

connect monitor cable

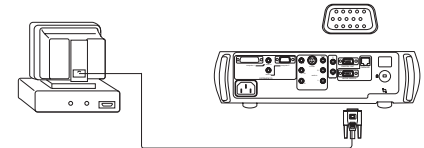

If you prefer connecting your computer to the projector with an optic  VESA cable, connect one end of the cable to the VESA port on your computer, and connect the other end of the cable to the blue **Computer 2** connector on the projector.

connect VESA cable

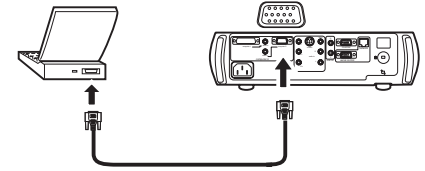

You can control the projector from an LCD control panel or computer by connecting an RS-232 cable to the projector's **Serial** connector. Specific RS-232 commands can be found in the Service and Support section of our website at www.proxima.com.

connect RS-232 cable

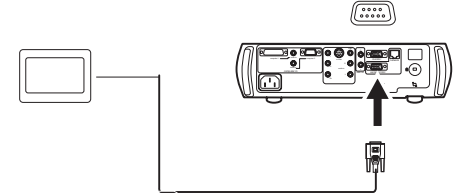

The projector can be managed by ProjectorNet networking software through its **Network** connector.

Contact an authorized Proxima dealer or visit the ProjectorNet website at www.infocus.com/projectornet for information on ProjectorNet.

connect network cable

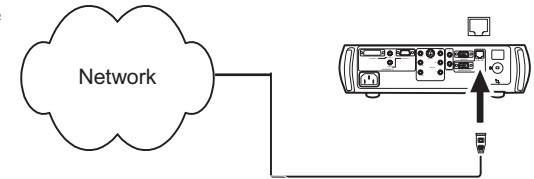

ProjectorNet



Displaying a computer image



Remove the lens cap.

remove lens cap

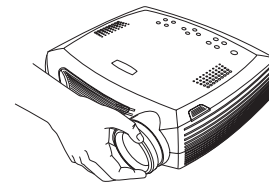

Press the **Power** button on the top of the projector or the remote.

The LED flashes green and the fans start to run. When the lamp comes on, the startup screen is displayed and the LED is steady green. It can take a minute for the image to achieve full brightness.

press Power

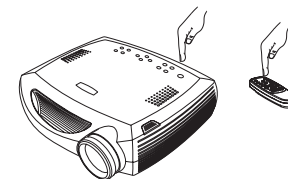

? No startup screen? Get help on page 17.

Turn on your computer.

turn on computer



The computer's image should appear on the projection screen. If it doesn't, press the **Computer** button on the projector's keypad.

Make sure your laptop's external video port is active.

Many laptops do not automatically turn on their external video port when a projector is connected. Usually a key combination like FN + F5 is used to turn the external display on and off. Refer to your computer's documentation to learn your computer's key combination.

activate laptop's external port

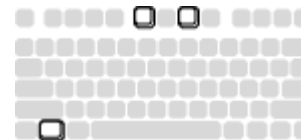

? No computer image? Try pressing the **Auto Image** button on the keypad. Get help on page 17.

First-time projector use with Windows 98



The first time you connect a computer running Windows 98 to the projector, the computer recognizes the projector as “new hardware” and the Add New Hardware Wizard appears. Follow these instructions to use the Wizard to load the correct driver (which was installed with your Windows operating system).

If you are running Windows 2000, Windows ME, or Windows XP, skip these steps and go to “Adjusting the image” on page 12.

a Click **Next** to begin searching for the driver.



b Make sure “Search for the best driver” is selected, then click **Next**.

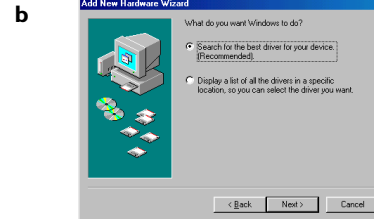

c Uncheck any checked boxes, then click **Next**. Windows automatically locates the driver. If this driver has been removed, reload the driver using your Windows operating system CD.



d When Windows finds the driver, you are ready to install it. Click **Next**.

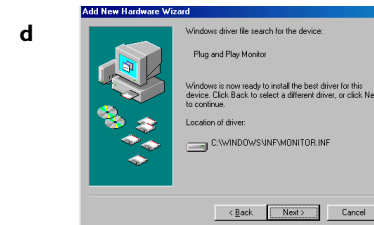

Skip this page if you did not connect a USB mouse cable 

For Windows 98:

- If you connected the USB cable, the Add New Hardware Wizard appears again. Drivers must be installed to use the USB functionality.
- **The Wizard launches three times.**

The first time it detects a USB Composite Device.

The second time a USB Human Interface Device (for the keyboard).

The third time it detects a USB Human Interface Device (for the mouse).

For Windows 2000, Windows ME, and Windows XP:

- The USB drivers are automatically installed.

Adjusting the image



Adjust the height of the projector, if necessary, by pressing the release button to extend the elevator foot.

Rotate the leveling foot, if necessary.

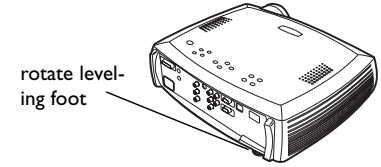
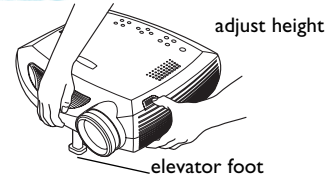

Position the projector the desired distance from the screen at a 90 degree angle to the screen.

See page 41 for a table listing screen sizes and distances.

adjust distance

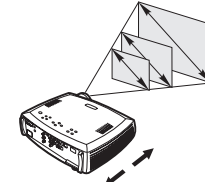

Adjust the zoom or focus rings by rotating them until the desired image size and sharpness are produced.

adjust zoom and focus

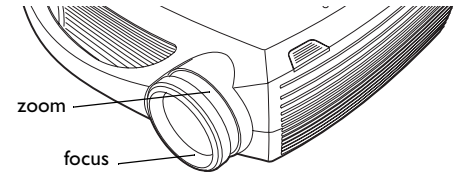

If the image is not square, adjust the keystone by using the buttons on the keypad.

Press the upper **Keystone** button to reduce the upper part of the image, and press the lower **Keystone** button to reduce the lower part.

adjust keystone

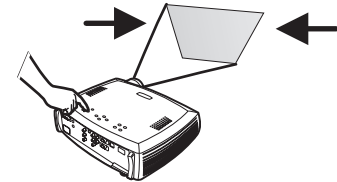

Adjust the Contrast or Brightness in the Picture menu.

See page 29 for help with the menus.

adjust Contrast or Brightness

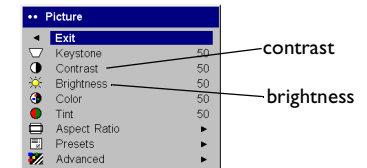

Connecting a video device



Standard video connections

Plug the video cable's yellow connector into the video-out connector on the video device. Plug the other yellow connector into the yellow **Video** connector on the projector.

Plug a white connector into the left audio out connector on the video device and plug a red connector into the right audio out connector on the video device.

Plug the remaining white connector into the left **audio in** connector on the projector, and plug the red connector into the right **audio in** connector on the projector.

connect video cable

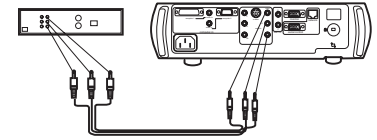

Connect the black power cable to the connector on the back of the projector and to your electrical outlet. The Power LED on the keypad turns solid green.

NOTE: Always use the power cable that shipped with the projector.

Optional video connections

If the video device uses a round, four-prong S-video connector, plug an S-video cable (sold separately) into the S-video connector on the video device and into the **S-video** connector on the projector. Use the video cable's audio connectors as described directly above (the yellow connectors on the video cable are not used).

connect power cable

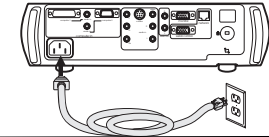

connect S-video and video cables

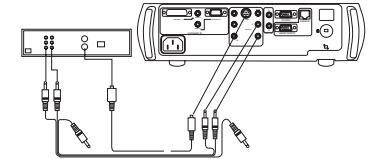

If the video device uses component cable connectors (sold separately), plug the cable's green connectors into the green component-out connector on the video device and into the green component connector (labeled "**Y**") on the projector. Plug the component cable's blue connectors into the blue component-out connector on the video device and into the blue component connector (labeled "**Pb**") on the projector. Plug the component cable's red connectors into the red component-out connector on the video device and into the red component connector (labeled "**Pr**") on the projector. Use the video cable's audio connectors as described directly above (the yellow connectors on the video cable are not used).

connect component cables and video cables

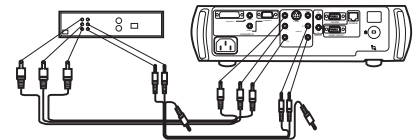

Displaying a video image



Remove the lens cap.

remove lens cap

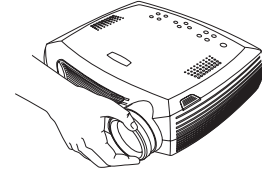

Press the **Power** button on the top of the projector.

The LED flashes green and the fans start to run. When the lamp comes on, the startup screen is displayed and the LED is steady green. It can take a minute for the image to achieve full brightness.

press Power

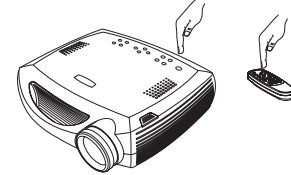

? No startup screen? Get help on page 16.

Plug in and turn on the video device.

The video device's image should appear on the projection screen. If it doesn't, press the **Video** button on the keypad.

turn on video device

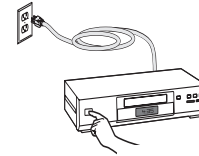

Adjust the height of the projector by pressing the release button to extend the elevator foot. Rotate the leveling foot, if necessary.

adjust height

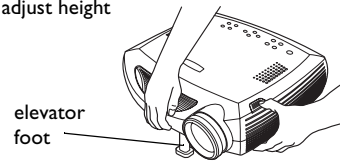

rotate leveling foot

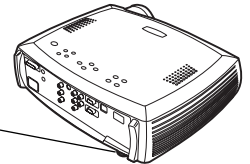

Position the projector the desired distance from the screen at a 90 degree angle to the screen. See page 41 for a table listing screen sizes and distances to the screen.

adjust distance

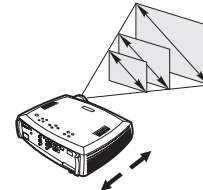

Adjust the zoom or focus rings by rotating them until the desired image size and sharpness are produced.

adjust zoom and focus

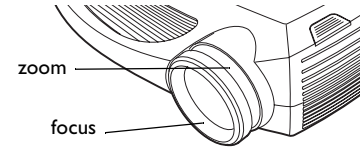

If the image is not square, adjust the keystone using the buttons on the keypad. Press the upper **Keystone** button to reduce the upper part of the image, and press the lower **Keystone** button to reduce the lower part.

adjust keystone

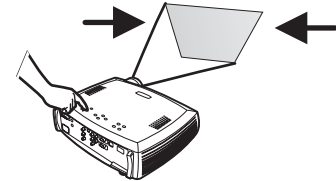

Adjust the volume on the keypad or remote.

adjust volume

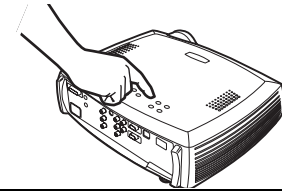

Adjust the **Contrast**, **Brightness**, **Color**, or **Tint** in the Picture menu.

See page 29 for help with the menus.

adjust Picture menu

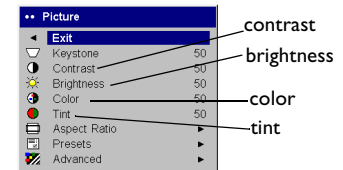

Shutting down the projector

The projector automatically displays a black screen after no active source is detected for 30 minutes. This black screen helps preserve the life of the projector. The image returns when an active source is detected or a remote or keypad button is pressed.

Screen Save

You can make the black screen appear after five minutes by turning on Screen Save in the **Settings>System** menu. See page 34. There are six time options for the Screen Save feature. They range from five minutes to 30 minutes with five minute intervals.

Power Save

The projector also has a Power Save feature that automatically turns the lamp off after no signals are detected for 20 minutes. After 10 additional minutes with no signal, the projector powers down. If an active signal is received before the projector powers down, the image is displayed. You must press the Power button to display an image after 30 minutes have passed. When Power Save is enabled, Screen Save is disabled. See page 33.

Turning off the projector

To turn off the projector, press the **power** button and verify that you want to turn the projector off by pressing the power button again within 3 seconds. You can cancel the shutdown by not pressing the **power** button a second time. The lamp turns off and the LED blinks green for 1 minute while the fans continue to run to cool the lamp. When the lamp has cooled, the LED lights green and the fans stop. Unplug the power cable to completely power off the projector.



If your image appears correctly on the screen, skip to the next section (page 25). If it does not, troubleshoot the setup.

The LED on top of the projector’s keypad indicates the state of the projector and can help you troubleshoot.

Table 1: LED behavior and meaning

LED color/behavior	Meaning
solid green	The projector is plugged in, or the projector has been turned on and the software has initialized. The projector has been turned off and the fans have stopped.
blinking green	The power button has been pressed and the software is initializing, or the projector is powering down and the fans are running to cool the lamp.
blinking red see page 41 for more information	A fan or lamp failure has occurred. Make sure the vents aren’t blocked (see page 22). Turn off the projector and wait one minute, then turn the projector on again. If the projector has been working for 2000 hours or more (page 37), replace the lamp and reset the lamp timer. Contact Technical Support if the problem persists.
solid red	An unidentifiable error: please contact Technical Support.

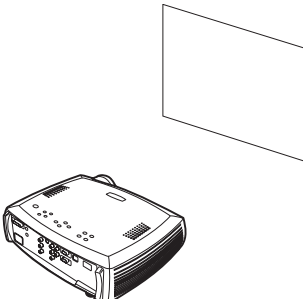
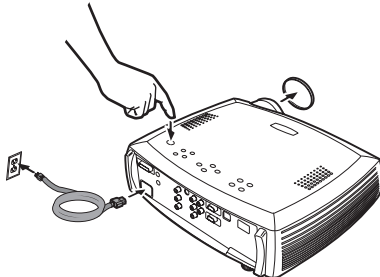
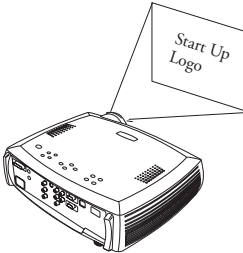
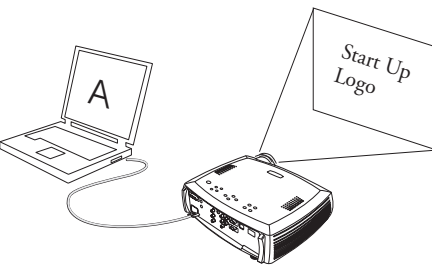
The following tables show common problems. In some cases, more than one possible solution is provided. Try the solutions in the order they are presented. When the problem is solved, you can skip the additional solutions.

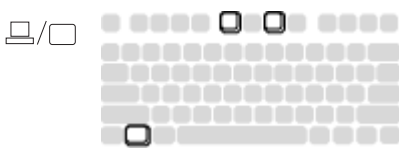
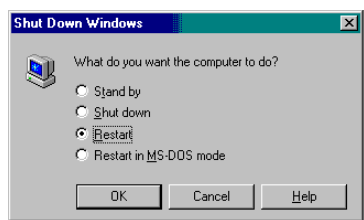
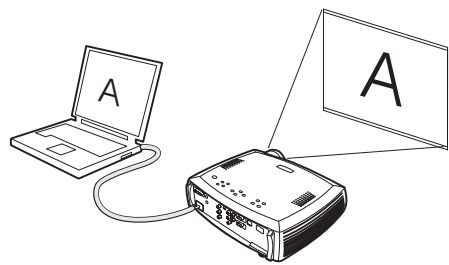
Problem	Solution	Result
<p>No startup screen</p> 	<p>Plug power cable in and remove lens cap press power button</p> 	<p>Correct image</p> 
<p>Only startup screen appears</p> 	<p>Press the Computer button </p> <p>Activate laptop's external port</p>  <p>or restart laptop</p> 	<p>Computer image projected</p> 

No computer image, just the words “Signal out of range”

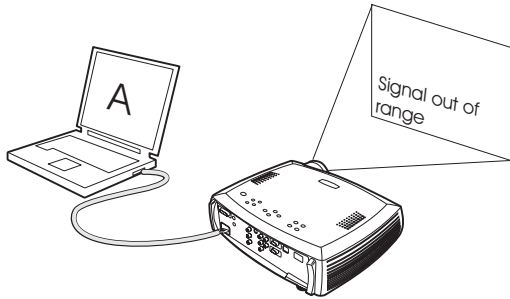

Adjust computer refresh rate in Control Panel>Display>Settings>Advanced>Adapter (location varies by operating system)



You may also need to set a different resolution on your computer, as shown in the following Problem, “Image fuzzy or cropped”

Computer image projected

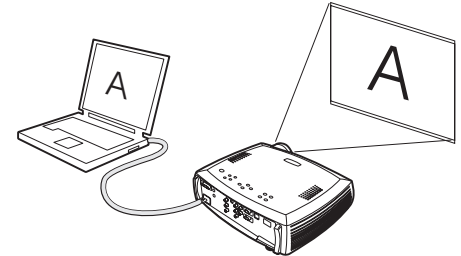
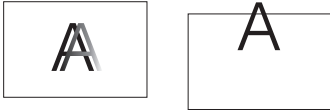

Image fuzzy or cropped



Set your computer's display resolution to the native resolution of the projector (Start>Settings>Control Panel>Display>Settings tab, select 1024x768)

For a laptop, disable laptop monitor or turn-on dual-display mode

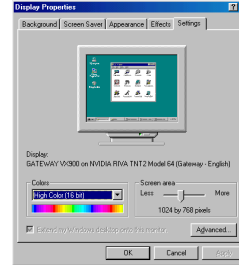
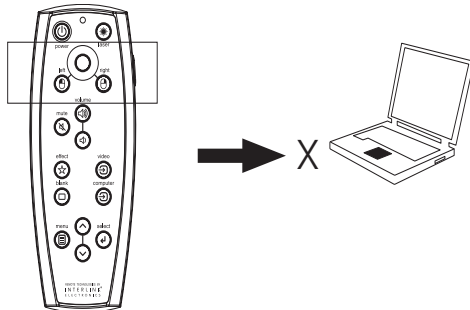

Image clear and not cropped



Remote control not controlling my computer's mouse



Connect computer cable (page 7), then, load USB drivers, if needed (page 10)

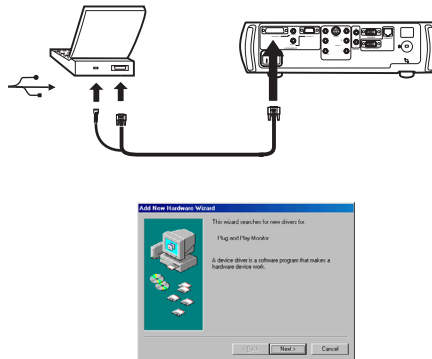

Remote controls computer cursor. Note that the mouse is not functional in zoom mode (see page 34)

See page 25 for information on the remote

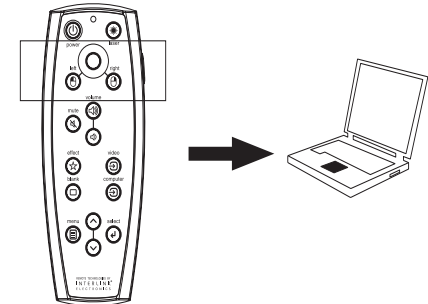







Problem	Solution	Result
<p>Image not square</p> 	<p>Adjust keystone on keypad</p> 	<p>Square image</p> 
<p>Edges of image distorted</p> 	<p>Turn Overscan on in the Picture>Advanced menu</p> 	<p>Correct image</p> 
<p>Image not sharp</p> 	<p>Adjust Sharpness in the Picture>Advanced menu</p> 	<p>Correct image</p> 

Image does not fit 16:9 screen

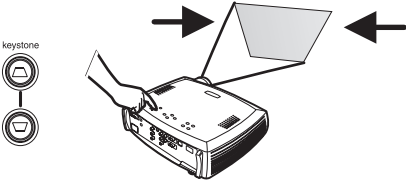

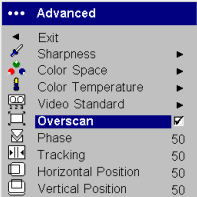
Change aspect ratio to 16:9 in
Picture>Aspect ratio menu

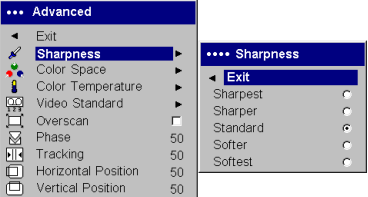

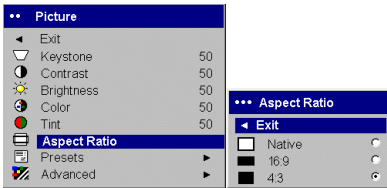
Correct image



Image upside down



Turn off Ceiling in Settings>System menu

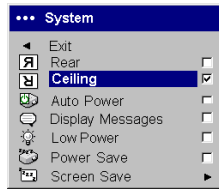

Correct image



Image reversed left to right



Turn off Rear in Settings>System menu

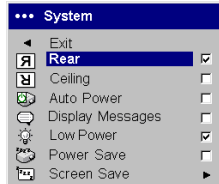

Correct image



Video image “torn” and fragmented

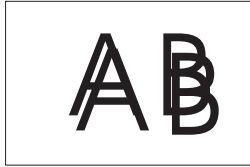

**Change Video Standard in
Picture>Advanced menu**

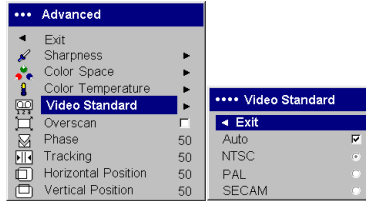

Correct image



Projected colors don't match source



**Adjust color, tint, color temperature,
brightness, contrast in the menus**

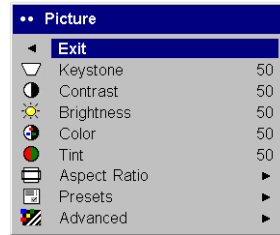

Correct image



Lamp won't turn on, LED blinking red (page 16)

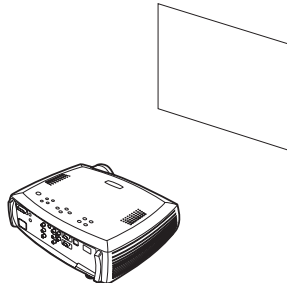

**Make sure vents aren't blocked; allow
projector to cool for one minute**

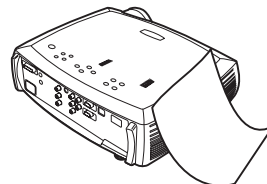

**Unplug projector; wait one minute; plug in
projector and turn it on: lamp lights**

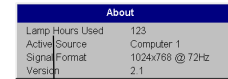

**Check lamp hours:
should be less
than 2,000 hours
in the
Main>About menu**

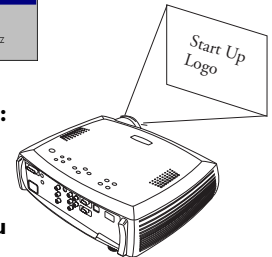

Lamp won't turn on, LED blinking red (page 16)

blinking red

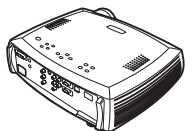

Lamp must be replaced (page 37)

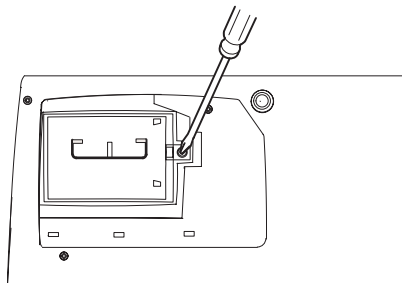

Lamp turns on

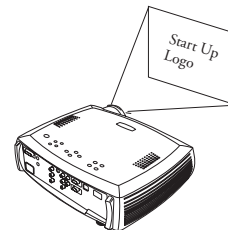
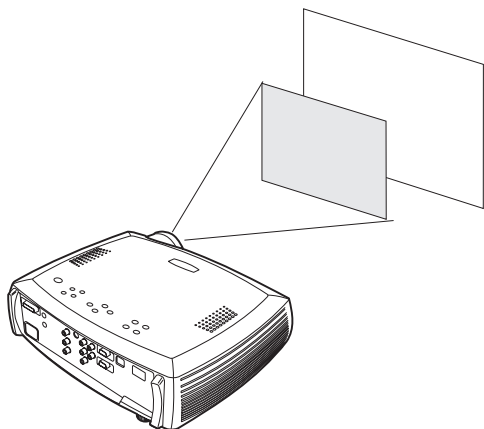
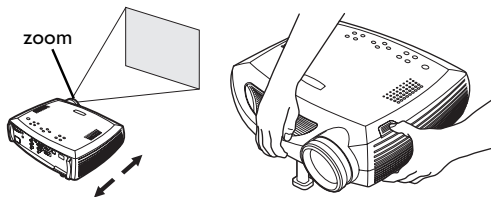

Image not centered on screen



Move projector, adjust zoom, adjust height



adjust horizontal or vertical position in
Picture>Advanced menu

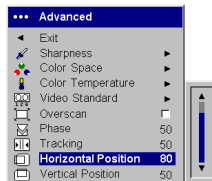

Correct image

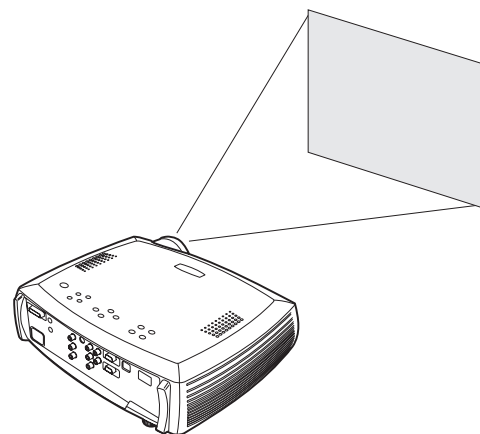

Regarding this projector

This product is backed by a limited two-year warranty. An extended warranty plan may be purchased from your dealer. When sending the projector in for repair, we recommend shipping the unit in the carry case in its original packing material, or having a professional packaging company pack the unit with all accessories for shipping. Do not ship the projector in the carry case alone. An optional ATA shipping case is available for purchase that provides adequate protection for shipping. Please insure your shipment for its full value.

Navigating the keypad buttons

Most buttons are described in detail in other sections, but here is an overview of their functions:

power—turns the projector on (page 9) and off (page 14).

menu—opens the on-screen menus (page 29).

select—confirms choices made in the menus (page 29).

up/down arrows—navigates to and adjusts settings in the menus (page 29).

auto image—resets the projector to the source.

presets—cycles through the available preset settings (page 31).

keystone—adjusts squareness of the image (page 12).

volume—adjusts sound (page 26).

video and computer—changes the active source.

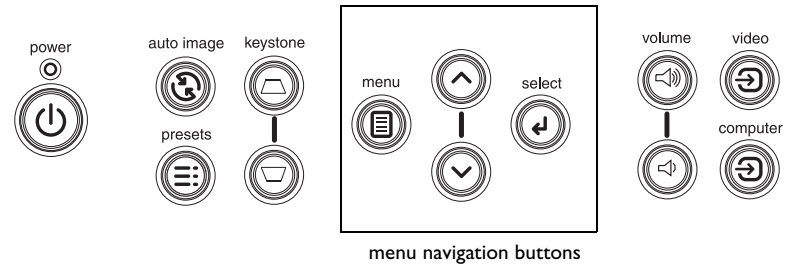

Using the remote control

The remote uses two (2) provided AAA batteries. They are easily installed by sliding the cover off the remote's back, aligning the + and - ends of the batteries, sliding them into place, and then replacing the cover.

To operate, point the remote at the projection screen or at the projector (not at the computer). The range of optimum operation is about 30 feet (9.14m).

To use the laser pointer, press and hold the **Laser** button. The laser turns off when the button is released, or times out after two (2) minutes of continuous operation.

Left and right remote mouse buttons are used to mimic the actions of the left/right mouse buttons on your computer. Mouse cursor movement is managed via the remote's Cursor control. Connect the USB connector on the computer cable to your computer to use these buttons and control your computer's mouse. When you do this for the first time, the Add New Hardware wizard may appear. See page 10 for details on loading the correct USB drivers.

Press the remote's **Menu** button to open the projector's menu system. Use the arrow buttons to navigate, and the Select button to select features and adjust values in the menus. See page 29 for more info on the menus.

The remote also has a power button to turn the projector on and off (see page 16 for shutdown info), volume and mute buttons to control the sound, a backlight button to light the remote's buttons in the dark, and video and computer buttons to switch between sources.

Two presentation-specific features are also provided. Use the blank button to display a blank screen instead of the current slide (you can choose which color is displayed, see page 34); use the effect button to invoke a user-definable action, such as freeze or zoom (see page 34 to learn to program this button).

If you are displaying presentations in Microsoft® PowerPoint®, you can use the remote's mouse buttons to navigate through your presentation while in Slide Show mode. To configure PowerPoint for this, choose Options from

 PowerPoint Tools menu, click the View Tab, de-select the "Popup Menu on Right Mouse Click" option in the Slide Show section, then click OK. Then, when you're in PowerPoint's Slide Show mode, a left click advances to the next slide and a right click returns to the previous slide (other PowerPoint modes are not affected).

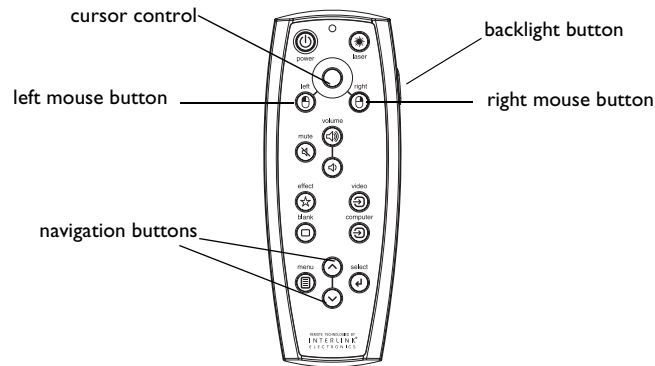

Troubleshooting the remote

- Make sure the batteries are installed in the proper orientation and are not dead.
- Make sure you're pointing the remote at the projector, not the computer, and are within the remote range of 30 feet (9.14m).
- If you are trying to control your computer's mouse, make sure the USB cable is connected. If using a USB cable, make sure the correct drivers are installed.

Using the audio



To play sound from the projector, connect your source to the Audio In connector on the projector.

To adjust the volume, use the buttons on the keypad or remote.

To mute the sound, press the **Mute** button.

Troubleshooting audio

If there is no sound, check the following:

- Make sure the audio cable is connected.
- Make sure mute isn't active.
- Make sure the volume is turned up enough. Press the volume button on the keypad or remote.
- Make sure that if you are connected to **Computer 1** on the back of the projector, that you are also connected to the corresponding **audio in**. If you are connected to **Computer 2**, be sure you are connected to its corresponding **audio in**.
- Adjust the audio source.
- If playing a video, make sure the playback has not been paused.

connect audio cable

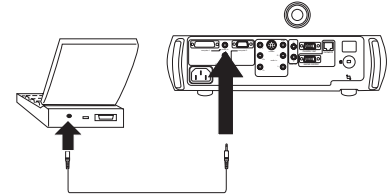

adjust volume

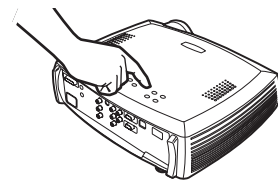
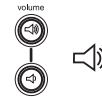

computer 1 and corresponding audio

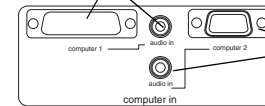

computer 2 and corresponding audio

Connecting external speakers

The projector can be attached to external speakers that have their own power source by plugging speaker cables into the projector's left and right **Audio Out** connectors.

external speakers

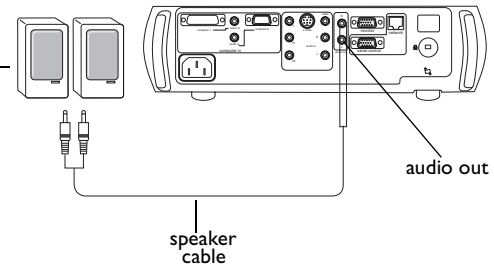

Optimizing computer images

After your computer is connected properly and the computer's image is on the screen, you can optimize the image using the onscreen menus. For general information on using the menus, see page 29.

- Adjust the Keystone, Contrast, or Brightness in the Picture menu.
- Change the Aspect Ratio. Aspect Ratio is the ratio of the image width to image height. TV screens are usually 1.33:1, also known as 4:3. HDTV and most DVDs are 1.78:1, or 16:9. Choose the option that best fits your input source. See page 30 for details.
- Adjust the Color Space or Color Temperature in the Advanced menu.
- Adjust the Phase, Tracking, or Horizontal or Vertical position in the Advanced menu.
- Once you have optimized the image for a particular source, you can save the settings using Presets. This allows you to quickly recall these settings later. See page 31.

Several features are provided to make giving presentation easier. The following is an overview, details are found in the menu section on page 29.

- The remote's **Effect** button allows you to assign various features to the key. The default effect is About, which displays information about the projector and current source. You can select from Blank, Mute, Aspect Ratio, Source, Auto Image, Freeze, Zoom, and About. See page 34 for details.
- The Freeze effect allows you to freeze the displayed image. This is useful if you want to make changes on your computer without your audience seeing them.
- The **Blank** button on the remote allows you to display a blank screen instead of the active source. See page 34.
- The Startup Logo menu option lets you change the default startup screen to a black, white, or blue screen. See page 34.
- Two menu options, Power Save and Screen Save, are provided to automatically shut down the projector after several minutes of inactivity or display a black screen. This helps preserve lamp life. See page 33 and page 34.
- A Low Power menu option is also available to help lower the projector's fan sound volume. See page 33.

Optimizing video images

After the video device is connected properly and the image is on the screen, you can optimize the image using the onscreen menus. For general information on using the menus, see page 29.

- Adjust the Keystone, Contrast, Brightness, Color, or Tint in the Picture menu. See page 30.
- Change the Aspect ratio. Aspect ratio is the ratio of the image width to image height. TV screens are usually 1.33:1, also known as 4:3. HDTV and most DVDs are 1.78:1, or 16:9. Choose the option that best fits your input source. See page 30.
- Select a Sharpness setting. See page 32.
- Adjust the Color Temperature. Select a listed value, or select User and individually adjust the intensity of the red, green, and blue color. See page 32.
- Select a different Video Standard. Auto tries to determine the standard of the incoming video. Select a different standard if necessary. See page 32.
- Turn overscan on to remove noise around the video image. See page 32.

PureGlare Optimizing the projector

You can customize the projector for your specific setup and needs. See page 33 to page 36 for details on these features.

- For rear projection, turn Rear mode on in the **Settings>System** menu.
- For ceiling mounted projection, turn Ceiling mode on in the **Settings>System** menu.
- Specify which source the projector checks first for active video during power-up.
- Specify the function of the Effect Key on the remote.
- Turn the projector's display messages on and off.
- Turn on power saving features.
- Specify blank screen colors and startup logos.
- Specify the menu language.

Using the menus



To open the menus, press the menu button on the keypad or remote. (The menus automatically close after 60 seconds if no buttons are pressed.) The Main menu appears. Use the arrow buttons to move up and down to highlight the desired submenu, then press the **Select** button.

To change a menu setting, highlight it, press **Select**, then use the up and down arrow buttons to adjust the value, select an option using radio buttons, or turn the feature on or off using check boxes. Press **Select** to confirm your changes. Use the arrows to navigate to another setting. When your adjustments are complete, navigate to Exit, then press **Select** to go to the previous menu; press the **Menu** button at any time to close the menus.

Dots appear before the menu name. The number of dots indicate the menu's level, ranging from one (the Main menu) to four (the most nested menus).

The menus are grouped by usage:

- The Picture menu provides image adjustments.
- The Settings menu provides set-up type adjustments that are not changed often.
- The About menu provides a read-only display of information about the projector and source.

Certain menu items may be hidden until a particular source is connected. For example, Sharpness is only available for video sources and will be hidden when a computer source is active. Other menu items may be grayed out when they are not available. For example, Brightness is grayed out until an image is active.

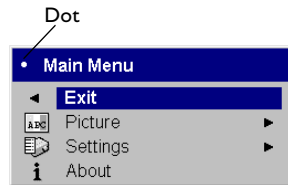

Main menu

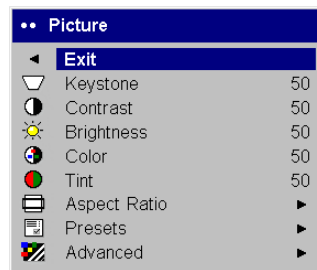
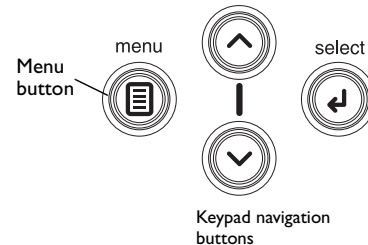

Picture menu

Dots

Settings menu

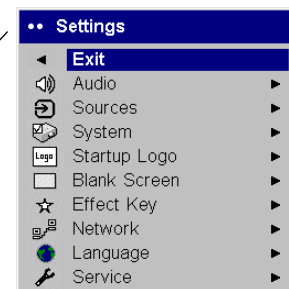

About menu

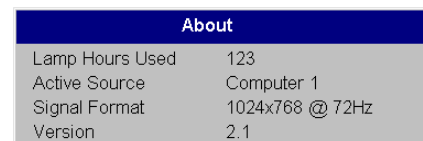

Picture menu

To adjust the following five settings, highlight the setting, press **Select**, use the up and down arrows to adjust the values, then press select to confirm the changes.

Keystone: adjusts the image vertically and makes a squarer image. You can also adjust keystone from the keypad.

Contrast: controls the degree of difference between the lightest and darkest parts of the picture and changes the amount of black and white in the image.

Brightness: changes the intensity of the image.

Color: (video sources only) adjusts a video image from black and white to fully saturated color.

Tint: (NTSC video sources only) adjusts the red-green color balance in the image.

Aspect Ratio: Aspect ratio is the ratio of the image width to image height. TV screens are usually 1.33:1, also known as 4:3. HDTV and most DVDs are 1.78:1, or 16:9. The default is 4:3, which displays the input resized up or down to fill the display area.

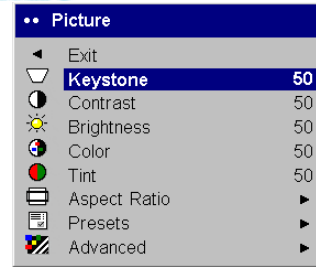

increasing keystone

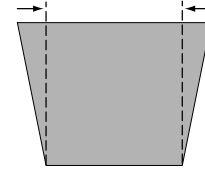

decreasing keystone

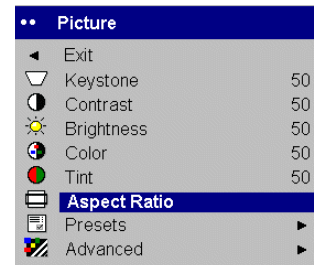
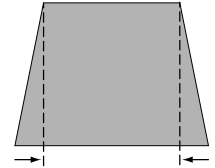

Aspect ratio

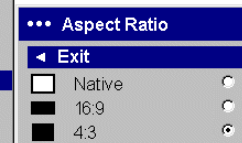

Presets: The provided Presets optimize the projector for displaying content from a computer,  PureGlare

puter presentations, photographs, film images, and video images. (Film input is material originally captured on a film camera, like a movie; video input is material originally captured on a video camera, like a TV show or sporting event.) You can use the preset as a starting point, then further customize the settings for each source. The settings you customize are saved in the preset for each source. To restore the factory default settings, choose Factory Reset in the **Settings>Service** menu.

There are also three user-definable presets. To set a preset for the current source, adjust the image, select **Save Settings** in the Presets menu, then choose Save User 1, 2, or 3. You can recall these settings in the future by selecting the appropriate user presets.

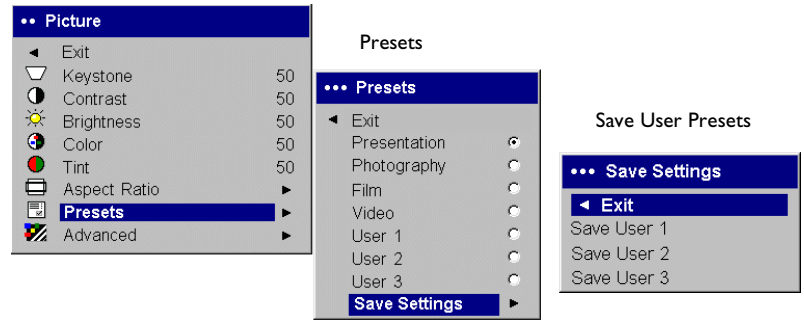

Advanced settings

Sharpness: (video sources only) changes the clarity of the edges of a video image. Select a sharpness setting.

Color Space: This option applies to computer and component video sources (it won't appear in the menu for S-video or composite video sources). It allows you to select a color space that has been specifically tuned for the video input. When Auto is selected, the projector automatically determines the standard. To choose a different setting, turn off Auto, then choose RGB for computer sources, choose either SMPTE240, REC709, or REC601 for component video sources.

Color Temperature: changes the intensity of the colors. Select a listed value, or select User and individually adjust the intensity of the red, green, and blue colors.

Video Standard: When it is set to Auto, the projector attempts to pick the video standard automatically based on the input signal it receives. (The video standard options may vary depending on your region of the world.) If the projector is unable to detect the correct standard, the colors may not look right or the image may appear "torn." If this happens, manually select a video standard by selecting NTSC, PAL, or SECAM from the Video Standard menu.

Overscan: (video sources only) removes noise around the video image.

The following 4 options are for computer sources only.

Phase: adjusts the horizontal phase of a computer source.

Tracking: adjusts the vertical scan of a computer source.

Horizontal/Vertical Position: adjusts the position of a computer source.

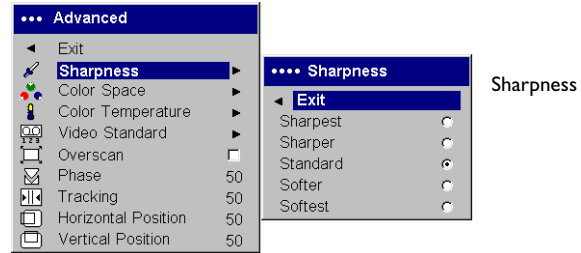

Sharpness

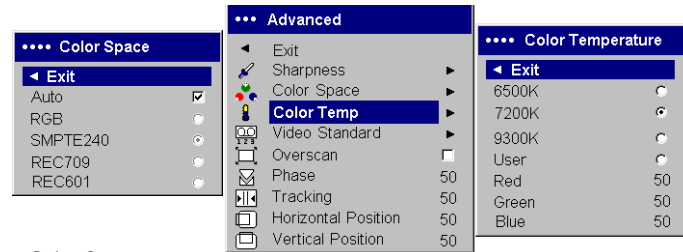

Color Space

Color Temperature

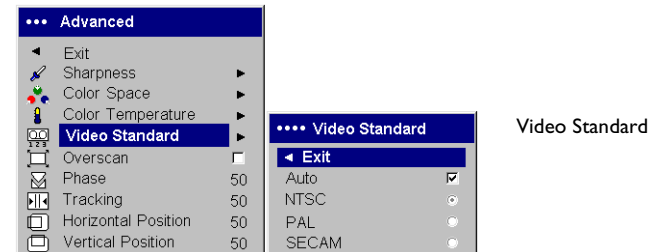

Video Standard

Settings menu



Audio: allows adjustments to the sound Balance between speakers and speaker Volume. The Internal speakers and projector startup Chime can be turned on or off by placing or removing a check in the respective check-boxes.

Sources>Power-up Source: this determines which source the projector checks first for active video during power-up.

Sources: allows you to assign a particular input to a specific source key as an optional full-featured remote. Also allows selection of a default Power-up Source and enables or disables Autosource. When Autosource is not checked, the projector defaults to the source selected in Power-up Source. If no source is found, a blank screen displays. When Autosource is checked, Power-up Source determines which source the projector defaults to at power-up. If no signal is present, the projector checks the sources in order until a source is found or until power down.

System>Rear: reverses the image so you can project from behind a translucent screen.

Ceiling: turns the image upside down for ceiling-mounted projection.

NOTE: It is recommended that all final image adjustments in Ceiling mode are made once the unit has fully warmed up.

Auto Power: When Auto Power is checked, the projector automatically goes into the startup state after the projector is powered on. This allows control of ceiling mounted projectors with a wall power switch.

Display Messages: displays status messages (such as “Searching” or “Mute”) in the lower-left corner of the screen.

Low Power: toggles between on and off. Turn it on to lower the light output of the lamp. This also lowers the fan speed, making the projector quieter.

Power Save: automatically turns the lamp off after no signals are detected for 20 minutes. After 10 additional minutes with no signal, the projector powers down. If an active signal is received before the projector powers down, the image will be displayed.

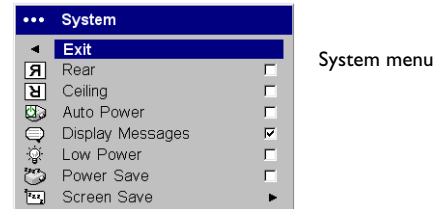
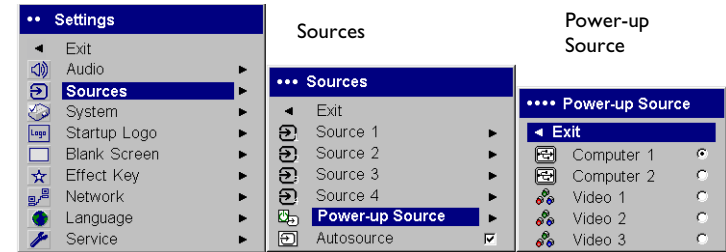
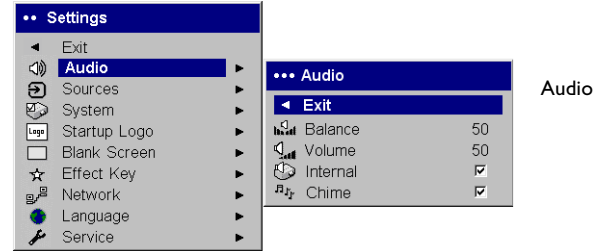

Screen Save: automatically blanks the screen with a black color after 

nals are detected for a preset number of minutes. The image returns when an active source is detected or a remote or keypad button is pressed. Screen Save is disabled when Power Save is enabled.

Startup Logo: allows you to display a blank Black, White, or Blue screen instead of the default screen at startup and when no source is detected.

Blank Screen: determines what color displays when you press the Blank button on the remote or there is a blank screen when no source is active.

Effect Key: allows you to assign a different function to the **Effect** button on the remote to quickly and easily use the effect. Only one effect can be enabled at a time. Highlight an effect and press **Select** to choose a different one.

Blank: shows an empty screen.

Mute: turns off all sound.

Aspect Ratio: sets the ratio of the image width to image height.

Source: cycles through the available sources.

Auto Image: causes computer sources to be reacquired.

Freeze: pauses the projected image.

Zoom: lets you magnify a part of the screen. To use the Zoom effect, press **Effect**, then press the remote's mouse left-click to zoom the image, press the mouse right-click to decrease the magnification. You can use the cursor control to pan the image, displaying different parts of it (only if the image is magnified). To return to the original size and cancel Zoom, press the **Effect** button a second time.

About: is the default effect. It displays the About menu.

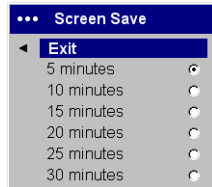

Screen Save



Startup logo

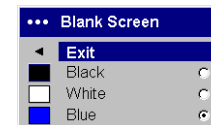

Blank Screen

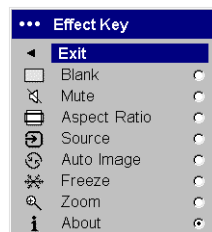

Effect Key

Network: The projector has an RJ45 Ethernet connector that supports  work connections and TCP/IP protocols. This will allow for the control and management of the projector over a corporate network. The following fields are accessible when DHCP is not checked and available for manual entry of data.

IP Address: Identifies the projector on the network.

Subnet mask: Separates the network address part of the IP address.

Default gateway: The IP address of the local router.

DHCP: Select this to automatically obtain an IP address, Subnet mask, and Default gateway.

Network Info: Provides information on the network configuration.

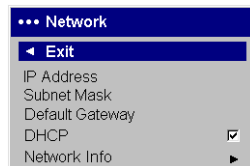

Network

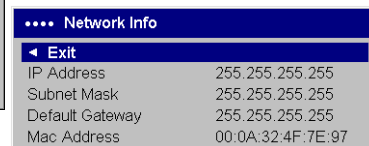

Network Info

The **Network Info** menu is informational and cannot be edited. It displays the current IP Address, Subnet Mask, Default Gateway, and the projector's MAC Address.

Language: allows you to select a language for the onscreen display of menus and messages.



Language

Service:

To use these features, highlight them and press **Select**.

Factory Reset: restores all settings (except Lamp Hours and Network settings) to their default after displaying a confirmation dialog box.

Lamp Reset: resets the lamp hours counter in the About menu to zero. Do this only after changing the lamp. It displays a confirmation dialog box.

Service Code: only used by authorized service personnel.

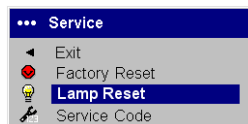

Service menu

Maintenance



Cleaning the lens

- 1 Apply a non-abrasive camera lens cleaner to a soft, dry cloth.

Avoid using an excessive amount of cleaner, and don't apply the cleaner directly to the lens. Abrasive cleaners, solvents or other harsh chemicals might scratch the lens.

- 2 Lightly wipe the cleaning cloth over the lens in a circular motion. If you don't intend to use the projector immediately, replace the lens cap.

clean the lens
with a soft dry cloth
and non-abrasive
cleaner

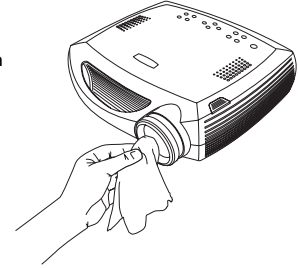

Replacing the projection lamp



The lamp hour timer in the About menu counts the number of hours the lamp has been in use. After 1,980 hours, the message “Change lamp” briefly appears on the screen at each startup. When the timer reaches 2,000 hours, the lamp will no longer light. You can order new lamp modules from your dealer. See “Accessories” on page 40 for information.

- 1 Turn off the projector and unplug the power cable.
- 2 Wait 60 minutes to allow the projector to cool thoroughly.

- 3 Turn the projector upside down and remove the lamp door by removing the two screws and sliding the lamp door tabs out of the three tab bays.

CAUTION: Never operate the projector with the lamp door removed. This disrupts the air flow and causes the projector to overheat.

- 4 Loosen the captive screw on the lamp module.

About	
Lamp Hours Used	123
Active Source	Computer 1
Signal Format	1024x768 @ 72Hz
Version	2.1

About menu

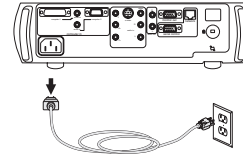

turn off and unplug the projector

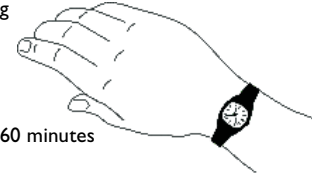

wait 60 minutes

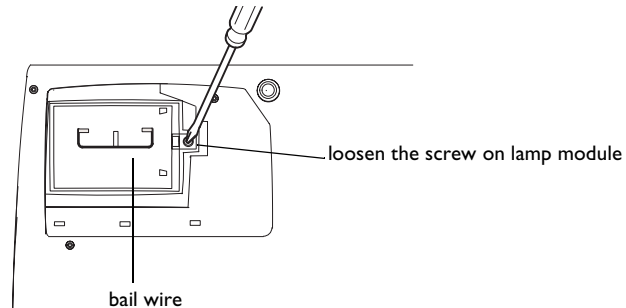
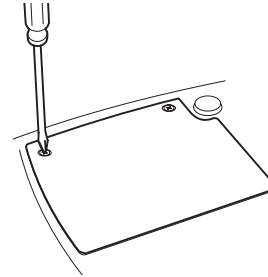

WARNINGS:



- To avoid burns, allow the projector to cool for at least 60 minutes before you replace the lamp.
 - Do not drop the lamp module. The glass may shatter and cause injury.
 - Do not touch the glass lamp screen. Fingerprints can obscure projection sharpness.
 - Be extremely careful when removing the lamp housing. In the unlikely event that the lamp ruptures, small glass fragments may be generated. The lamp module is designed to contain most of these fragments, but use caution when removing it.
- 5 Carefully remove the lamp module by grasping and lifting the metal bail wire. Dispose of the lamp in an environmentally proper manner.
 - 6 Install the new lamp module, making sure that it is properly seated.
 - 7 Tighten the single screw.
 - 8 Replace the lamp door by sliding the tabs into the tab bays and tightening the two screws.
 - 9 Plug in the power cable, then press the **Power** button to turn the projector back on.
 - 10 Reset the lamp hour timer.

Resetting the lamp timer

If the lamp timer has reached the maximum number of hours for the projector lamp (2,000 hours), the LED on the projector's keypad will show a lamp error (see "LED behavior and meaning" on page 16). To reset the lamp age, simultaneously holding down the two **Volume** keys on the projector's keypad for 10 seconds. At that point the LED will turn green and you can power on the projector.

You can also navigate to the **Settings>Service** menu and select **Lamp Reset** to reset the lamp timer.

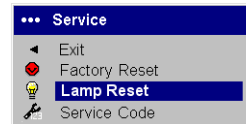

reset lamp time in Service menu

Using the security lock

The projector has a security lock for use with a PC Guardian Cable Lock System. See "Accessories" on page 40 for ordering information. Refer to the information that came with the lock for instructions on how to use it.

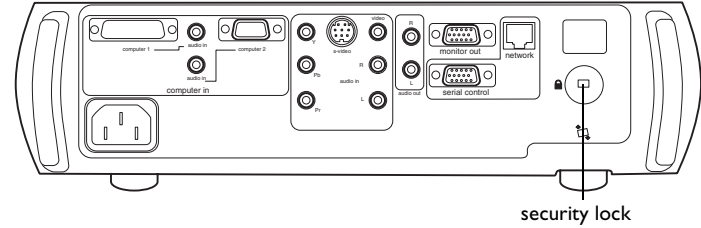

Specifications

Temperature	Operating	50 to 95° F (10 to 35° C) at 0 - 10,000 feet
	Non-operating	-4 to 158° F (-20 to 70° C) at 0 -20,000 feet
Altitude	Operating	0 to 10,000 feet (3,048 meters)
	Non-operating	0 to 20,000 feet (6,096 meters)
Humidity	Operating	10% to 95% relative humidity, non-condensing
	Non-operating	10% to 90% relative humidity, non-condensing
Dimensions		13.8 x 12.8 x 4.3" (351W x 325L x 110H mm)
Weight		9.3 lbs. (4.24 kg) unpacked
Optics	Focus Range	5 - 32.8 feet (1.5 - 10 meters)
	Lamp Type	250-watt UHP lamp
Input Power Requirements		100V-120V 4A, 50/60 Hz 200V-240V 2A 50 Hz
Ceiling Mount		UL tested/listed ceiling mount with minimum capacity of 46 lbs (20.87 kg)

Standard Accessories (ship with the projector)	Part Number
Carrying Case	110-0585-xx
Shipping Box (with packaging)	110-0592-xx
Computer Cable 6 ft (1.8 m)	SP-DVI-A
Audio/Video Cable 6 ft (1.8 m)	210-0053-01
Audio Cable 6 ft (1.8 m)	210-0118-xx
Power Cable (country-dependent)	210-0023-xx
Conductor Plus Remote	590-0561-20
Projection Lamp Module (included in projector)	SP-LAMP-006
Lens Cap	505-1247-xx
Quick Setup card	009-0657-xx
User's Guide	010-0391-xx
Safety Card	009-0659-xx
Color-coded Cable Ties, 3 set	SP-CABLETIES

Optional Accessories	Part Number
Shipping Case (ATA approved)	CA-ATA-013
Samsonite Deluxe Travel Case (accommodates projector and laptop)	CASE-801
Projector Mount	SP-CEIL-005
False Ceiling Plate for Projector Mount	SP-LTMT-PLT

Optional Accessories	Part Number
Extension Arm for Projector Mount 26" - 47"	SP-LTMT-EXTP
PC Guardian Cable Lock System	SP-LOCK
50" Diagonal Screen (portable)	A650
60" Diagonal Screen (portable)	HW-DLXSCRN
84" Diagonal Wall/Ceiling Mounted Screen	HW-WALLSCR84
Portable Projector Stand	SP-STND
Replacement Lamp Module	SP-LAMP-006
MindPath RF PocketPoint Remote	HW-RF-POCKTPNT
IR Presentation Remote Control	590-0562-xx

Three (3) blinks

Four (4) blinks

Five (5) blinks

Table 2:

The projector has shut down the lamp. Replace the lamp. Contact Technical Support for repair if replacing the lamp does not solve the problem..

The fan has failed. Replace the lamp (the lamp module contains a fan). Contact Technical Support for repair if replacing the fan does not solve the problem.

The projector is overheating. Check for a blocked air vent. Contact Technical Support for repair if clearing the air vents does not solve the problem.

NOTE: Use only approved accessories.

Red LED Behavior and Projector Errors

If the projector is not functioning properly and the red LED is blinking, consult **Table 2** to determine a possible cause. There are two second pauses between the blinking cycles. Visit the Service and Support section of our website at www.proxima.com for more details on the red LED error codes.

Table 2:

Red LED Behavior	Explanation
One (1) blink	The lamp won't strike after five (5) attempts. Check the lamp and lamp door installations for loose connections.
Two (2) blinks	The lamp counter hours have exceed lamp life hours. Replace the lamp and reset the lamp hours counter.

Projected image size

Table 3:

Range of distance to the screen for a given screen size for DP6500x

Diagonal Screen Size (inches/m)	Image Width (inches/m)	Distance to screen	
		Maximum distance (feet/m)	Minimum Distance (feet/m)
40/1.0	32/0.8	6.9/2.1	5.0/1.5
50/1.3	40/1.0	8.7/2.6	6.2/1.9
60/1.5	48/1.2	10.4/3.2	7.5/2.3
100/2.5	79/2.0	17.4/5.3	12.4/3.8
150/3.8	119/3.0	26.0/7.9	18.7/5.7
200/5.1	158/4.0	34.7/10.6	24.9/7.6

NOTE: Visit our website at www.proxima.com for an interactive image size calculator.

Numerics

1024x768 resolution 5

A

About 34

altitude limits 40

Aspect Ratio 34

audio 26

Audio In connector 7, 13

audio volume 15

Auto Image 34

Auto Power 33

B

Blank 34

blinking green 16

blinking red 16

Brightness 12

C

cables

 optional 41

cleaning the lens 36

Color 15

colors are incorrect 22

component cable connector 13

Computer 1 connector 7

Computer 2 connector 8

computer connections

 optional 7

 required 7

computer image

 optimize 27

Contrast 12, 15

D

Declaration of Conformity 2

Default gateway 35

DHCP 35

Display Messages 33

USB 11

Windows 98 11

E

Effect Key 34

elevator foot 12

F

FCC warning 2

first time use

 driver installation 10

focus 12, 15

Freeze 34

fuzzy image 19

I

image

 display video 14

image display

 computer 9

image does not fit screen 21

image edges distorted 20

image not centered 23

image not sharp 20

image not square 20

image reversed 21

image size matrix 41

image torn 22

image upside down 21

Info

 network 35

IP Address 35

K

Keypad Buttons 24

Keystone 12, 15

L

- lamp replacement 37
- lamp won't turn on 22, 23
- Language 35
- laptop
 - external video port 9

LED

- blinking green 16
- blinking red 22, 41
- solid green 16
- solid red 23

- LED behavior 16

- Lens cleaning 36

- leveling foot 12

- Low Power 33

M

- Main menu 29

- menu system 29

- Monitor connector 7

- mouse, using your 7

- Mute 34

N

- Network 35

- Network connector 8

- Network Info 35

- no computer image 18

- no startup screen 17

O

- only startup screen appears 17

- optional accessories 41

P

- Picture menu 30

- Power button 14

- power cable 7, 13

- Power Save 33

- PowerPoint

 PureGlare remote's mouse buttons 25

- presentation features 27

- projector

 - customizing 28

 - errors 41

 - optional accessories 41

 - shutdown 16

 - standard accessories 40

 - troubleshooting problems 16

- projector height 12, 14

- projector positioning 12, 14

- projector specifications 40

R

- Rear 33

- Red LED blinking, 22, 41

- remote control 25

 - not working 19

- Remote control warning 2

- replacing the lamp 37

- RS-232 cable 8

S

- Safety Certifications 2

- security lock 39

- Serial connector 8

- Settings menu 33

- shutdown

 - projector 16

 - solid green 16

 - solid red 16

 - Source 34

 - Source troubleshooting 17

 - Sources 33

 - standard accessories

 - projector 40

 - Subnet mask 35

 - S-video connector 13

T

temperature limits 40

Tint 15

Troubleshooting 16, 17

U

USB, using your mouse 7

V

VESA port 8

Video button 14

video connections

 optional 13

 standard 13

Video connector 13

video images

 optimizing 28

W

warranty 24, 45

Windows 2000 11

Windows 98 10

Windows ME 11

Windows XP 11

X

XGA 5

Z

zoom 12, 15, 34

Limited Warranty

InFocus Corporation (“InFocus”) warrants that the Projector (“Product”) purchased from InFocus, an InFocus distributor, or an InFocus reseller will conform to the manufacturer’s specifications and be free from defects in material or workmanship for the Warranty period provided below. InFocus does not warrant that the Product will meet the specific requirements of the end-user customer.

If the Product, which is the subject of this Limited Warranty, is defective in material or workmanship during the warranty period, InFocus, at its option, will REPAIR or REPLACE the Product.

All exchanged parts and products replaced under this Warranty will become property of InFocus. InFocus’ sole obligation is to supply (or pay for) all labor necessary to repair the Product found to be defective within the Warranty period and to repair or replace defective parts with new parts or, at the option of InFocus, serviceable used parts that are equivalent or superior to new parts performance.

Limited Warranty Alternatives: Subject to the Limitations, Exclusions and Disclaimers, InFocus Warrants as follows:

- **2 Year Parts and Labor Product Warranty** - From the date of purchase, InFocus warrants that the Product will conform to the manufacturers’ specifications and be free from defects in material or workmanship for a period of two (2) years.
- **1 Year Parts Only Accessory Warranty** - From the date of purchase, InFocus warrants that the customer replaceable and accessory products will conform to the manufacturers’ specifications and be free from defects in material or workmanship for a period of one (1) year.
- **90 Day/500 Hour Replacement Lamp Warranty** - Lamp Products purchased in projectors or separately as replacements after the original projector purchase is Ninety (90) days or 500 hours, whichever comes first. During the Warranty period for the Product, InFocus warrants that Replacement lamps, which are purchased at the time of projector purchase, will have a 90-day or 500 hour warranty, whichever comes first, from the date the spare lamp is put into use.

THIS WARRANTY SETS FORTH INFOCUS’ MAXIMUM LIABILITY FOR ITS PRODUCT. THIS WARRANTY EXTENDS ONLY TO PRODUCTS PURCHASED FROM INFOCUS OR AN INFOCUS AUTHORIZED RESELLER. InFocus shall have no further obligation under the foregoing Limited Warranty if the Product has been damaged due to abuse, misuse, neglect, smoke exposure (cigarette or otherwise), accident, unusual physical or electrical stress, unauthorized modifications (including use of an unauthorized mount), tampering, alterations, or service other than by InFocus or its authorized agents, causes other than from ordinary use or failure to properly use the Product in the application for which said Product was intended.

This Warranty excludes Product or accessory cleaning, repair, or replacement of plastics due to cosmetic damage and damage as a result of normal wear. Product repair outside of the terms of the Limited Warranty will be on a time and materials basis. Prolonged Product “demonstration” causes unusual Product wear and is not considered normal use under the terms of this Limited Warranty.

The Accessory Warranty covers the accessory item only and excludes normal wear. The Lamp Product Warranty excludes expected lamp degradation.

Remanufactured Products and Software Products are exempt from the foregoing Limited Warranty. Please refer to the appropriate Remanufactured Product Limited Warranty or Software Product Limited Warranty for applicable Warranty information.

DISCLAIMER OF UNSTATED WARRANTIES

THE WARRANTY PRINTED ABOVE IS THE ONLY WARRANTY APPLICABLE TO THIS PRODUCT. ALL OTHER WARRANTIES, EXPRESS OR IMPLIED, INCLUDING, BUT NOT LIMITED TO, THE IMPLIED WARRANTIES OF MERCHANTABILITY AND FITNESS FOR PARTICULAR PURPOSE ARE DISCLAIMED. THERE ARE NO WARRANTIES THAT EXTEND BEYOND THE DESCRIPTION ON THE FACE HEREOF AND THE FOREGOING WARRANTY SHALL NOT BE EXTENDED, ALTERED OR VARIED EXCEPT BY WRITTEN INSTRUMENT SIGNED BY INFOCUS. SOME JURISDICTIONS DO NOT ALLOW LIMITATIONS ON HOW LONG AN IMPLIED WARRANTY MAY LAST, SO SUCH LIMITATIONS MAY NOT APPLY TO YOU.

Limited Warranty Period

The Limited Warranty period commences on the date of purchase by the end-user customer for both the 2 year Product Warranty and the 1 year Accessory Warranty. These Limited Warranty provisions shall apply only to the end-user purchaser (first person or entity that purchased a new Product for personal or business use and not for the purpose of distribution or resale).

To Be Eligible For Limited Warranty Coverage

Any person exercising a claim under this Limited Warranty must establish to the satisfaction of InFocus both the date of purchase and that the Product was purchased new. The sales receipt or invoice, showing the date of purchase of the Product or Accessory is the proof of the date of purchase.

To Obtain Warranty Service

During the Limited Warranty period, to exercise this Limited Warranty, the purchaser must first contact 1) InFocus, 2) a service facility authorized by InFocus or 3) the place of original purchase.

InFocus Customer Service - 1-800-799-9911 or techsupport@infocus.com

For Warranty service, the purchaser will be advised to return or deliver the defective Product freight and all fees prepaid, to an InFocus Service Center or to a service facility authorized by InFocus. When returning Product to InFocus, a Return Material Authorization Number (RMA #) is required and must be clearly displayed on the outside of the shipping carton or a similar package affording an equal degree of protection. InFocus or the service facility authorized by InFocus will return the repaired/replaced Product freight prepaid to the purchaser.

Products returned for Warranty service must be accompanied by a written letter that: (i) explains the problem; (ii) provides proof of date of purchase; (iii) provides the dealer's name; and (iv) provides the model and serial number of the Product. Upon request of InFocus Corporation or an InFocus authorized repair center receiving the Product, proof of legal importation must accompany the warranty repair Product, otherwise the Product must be returned to the place of original purchase, to the manufacturer (Purchaser must bear all tax, duty and freight), or the Purchaser must bear charges for the warranty repair.

LIMITATION OF LIABILITY

IT IS UNDERSTOOD AND AGREED THAT INFOCUS' LIABILITY WHETHER IN CONTRACT, IN TORT, UNDER ANY WARRANTY, IN NEGLIGENCE OR OTHERWISE SHALL NOT EXCEED THE RETURN OF THE AMOUNT OF THE PURCHASE PRICE PAID BY PURCHASER AND UNDER NO CIRCUMSTANCES SHALL INFOCUS BE LIABLE FOR SPECIAL, INDIRECT, INCIDENTAL OR CONSEQUENTIAL DAMAGES OR LOST PROFITS, LOST REVENUES OR LOST SAVINGS. THE PRICE STATED FOR THE PRODUCTS IS A CONSIDERATION IN LIMITING INFOCUS' LIABILITY.

Limitation on Bringing Action - No action, regardless of form, arising out of the agreement to purchase the product may be brought by purchaser more than one year after the cause of action has accrued.

Governing Law - Any action, regardless of form, arising out of the agreement to purchase the product is governed by Oregon law.

Mandatory Arbitration - Any action, regardless of form, arising out of the agreement to purchase the product is subject to mandatory arbitration.

SOME JURISDICTIONS DO NOT ALLOW THE EXCLUSION OR LIMITATION OF INCIDENTAL OR CONSEQUENTIAL DAMAGES SO THE ABOVE LIMITATION OR EXCLUSION MAY NOT APPLY TO YOU. THIS LIMITED WARRANTY GIVES YOU SPECIFIC LEGAL RIGHTS, AND YOU MAY ALSO HAVE OTHER RIGHTS, DEPENDING ON JURISDICTION.