

# Projector

## CP-A100

### User's Manual (detailed) Operating Guide

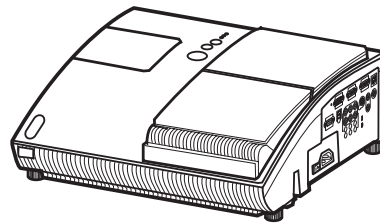

Thank you for purchasing this projector.

**⚠ WARNING** ▶ Before using this product, please read all manuals for this product. Be sure to read "Safety Guide" first. After reading them, store them in a safe place for future reference.

#### About this manual

Various symbols are used in this manual. The meanings of these symbols are described below.

- ⚠ WARNING** This symbol indicates information that, if ignored, could possibly result in personal injury or even death due to incorrect handling.
- ⚠ CAUTION** This symbol indicates information that, if ignored, could possibly result in personal injury or physical damage due to incorrect handling.

 Please refer to the pages written following this symbol.

**NOTE** • The information in this manual is subject to change without notice.  
• The manufacturer assumes no responsibility for any errors that may appear in this manual.  
• The reproduction, transfer or copy of all or any part of this document is not permitted without express written consent.

#### Trademark acknowledgment

- Mac is registered trademarks of Apple Computer, Inc.
  - VESA and SVGA are trademarks of the Video Electronics Standard Association.
  - Windows is a registered trademark of Microsoft Corporation.
- All other trademarks are the properties of their respective owners.

Contents

Contents

|  |           |   |           |
|--|-----------|---|-----------|
| <b>About this manual</b> . . . . .   | <b>1</b>  | <b>PICTURE menu</b> . . . . .   | <b>28</b> |
| <b>Contents</b> . . . . .  | <b>2</b>  | BRIGHTNESS, CONTRAST, GAMMA,  |           |
| <b>Projector features</b> . . . . .  | <b>3</b>  | COLOR TEMP, COLOR, TINT,  |           |
| <b>Preparations</b> . . . . .  | <b>3</b>  | SHARPNESS, MY MEMORY  |           |
| Contents of package . . . . .  | 3         | <b>IMAGE menu</b> . . . . .   | <b>31</b> |
| <b>Part names</b> . . . . .  | <b>4</b>  | ASPECT, OVER SCAN, V POSITION,  |           |
| Projector . . . . .  | 4         | H POSITION, H PHASE, H SIZE,  |           |
| Control buttons . . . . .  | 5         | AUTO ADJUST EXECUTE   |           |
| Ports . . . . .  | 5         | <b>INPUT menu</b> . . . . .   | <b>33</b> |
| Remote control . . . . .   | 6         | PROGRESSIVE, VIDEO NR, COLOR SPACE,   |           |
| <b>Setting up</b> . . . . .  | <b>7</b>  | COMPONENT, VIDEO FORMAT, FRAME LOCK,  |           |
| Arrangement . . . . .  | 7         | COMPUTER IN, RESOLUTION   |           |
| Connecting with your devices . . . . .   | 10        | <b>SETUP menu</b> . . . . .   | <b>36</b> |
| Connecting with a power supply . . . . .   | 12        | D-ZOOM, D-SHIFT V, D-SHIFT H,   |           |
| Using the security bar and slot . . . . .  | 13        | KEYSTONE  , WHISPER, MIRROR, |           |
| Using the cable cover . . . . .  | 13        | VOLUME, SPEAKER, AUDIO  |           |
| <b>Remote control</b> . . . . .  | <b>14</b> | <b>SCREEN menu</b> . . . . .  | <b>38</b> |
| Preparing for the remote control . . . . .   | 14        | LANGUAGE, MENU POSITION, BLANK,   |           |
| Changing the frequency of remote control signal . . . . .  | 15        | START UP, MyScreen, MyScreen Lock,  |           |
| Using as a simple PC mouse & keyboard . . . . .  | 15        | MESSAGE, SOURCE NAME  |           |
| <b>Power on/off</b> . . . . .  | <b>16</b> | <b>OPTION menu</b> . . . . .  | <b>42</b> |
| Turning on the power . . . . .   | 16        | AUTO SEARCH, AUTO ON, AUTO OFF,   |           |
| Turn off the power . . . . .   | 17        | LAMP TIME, FILTER TIME, MY BUTTON,  |           |
| <b>Operating</b> . . . . .   | <b>18</b> | SERVICE, SECURITY   |           |
| Adjusting the volume . . . . .   | 18        | <b>NETWORK menu</b> . . . . .   | <b>55</b> |
| Temporarily muting the sound . . . . .   | 18        | SETUP, PROJECTOR NAME, e-SHOT,  |           |
| Selecting an input signal . . . . .  | 18        | INFORMATION, SERVICE  |           |
| Searching an input signal . . . . .  | 19        | <b>C.C. (closed caption) menu</b> . . . . .   | <b>60</b> |
| Selecting an aspect ratio . . . . .  | 19        | DISPLAY, MODE, CHANNEL  |           |
| Adjusting the projection position . . . . .  | 20        | <b>Maintenance</b> . . . . .  | <b>61</b> |
| Adjusting the zoom . . . . .   | 20        | Replacing the lamp . . . . .  | 61        |
| Adjusting the picture position . . . . .   | 20        | Maintaining the air-filter . . . . .  | 63        |
| Adjusting the focus . . . . .  | 21        | Replacing the clock battery . . . . .   | 65        |
| Using the automatic adjustment feature . . . . .   | 21        | Caring for the mirror and lens . . . . .  | 66        |
| Correcting the keystone distortions . . . . .  | 22        | Other care . . . . .  | 67        |
| Using the magnify feature . . . . .  | 22        | <b>Troubleshooting</b> . . . . .  | <b>68</b> |
| Freezing the screen . . . . .  | 23        | Related messages . . . . .  | 68        |
| Temporarily blanking the screen . . . . .  | 23        | Regarding the indicator lamps . . . . .   | 69        |
| Using the menu function . . . . .  | 24        | Shutting the projector down . . . . .   | 70        |
| <b>EASY MENU</b> . . . . .   | <b>26</b> | Resetting all settings . . . . .  | 70        |
| ASPECT, D-ZOOM, KEYSTONE  , |           | Phenomena that may be easy  |           |
| PICTURE MODE, BRIGHTNESS, CONTRAST,  |           | to be mistaken for machine defects . . . . .  | 71        |
| COLOR, TINT, SHARPNESS, WHISPER,   |           | <b>Specifications</b> . . . . .   | <b>74</b> |
| MIRROR, RESET, FILTER TIME,  |           |   |           |
| LANGUAGE, Go to Advanced Menu...   |           |   |           |

## Projector features / Preparations

### Projector features

This product realizes the large projection image of various image signals, even if in a small space. This product can offer you convenience and various uses by the following features.

- ✓ The unique lens and mirror system realizes ultra short distance projection, which gives you more various way of use.
- ✓ The motorized lens door offers you very simple use of the projector.
- ✓ This projector can be controlled and monitored via LAN connection.

### Preparations

#### Contents of package

Please see the “Checking the contents” section in the User’s Manual (concise) which is a book. Your projector should come with the items shown there. Contact immediately your dealer if anything is missing.

**NOTE** • Keep the original packing materials, for future reshipment. Be sure to use the original packing materials when moving the projector. Use special caution for the lens.

Part names

Part names

**Projector**

- (1) Control buttons  
(See the following page.)
- (2) Lamp cover ( [16](#) )
- (3) Remote sensors ( [14](#) )
- (4) Speaker ( [37](#) )
- (5) Exhaust vents
- (6) Lens door ( [16](#), [66](#) )
- (7) Ports ( [5](#), [10](#) )
- (8) AC inlet ( [12](#) )
- (9) Power switch ( [16](#) )
- (10) Security bar ( [13](#) )
- (11) Intake vents
- (12) Filter unit ( [63](#) )
- (13) Elevator feet ( [20](#) )
- (14) Battery cover ( [65](#) )
- (15) Internal threads  
These are threads for optional mounting accessories.
- (16) Lens ( [16](#), [66](#) )
- (17) Mirror ( [16](#), [66](#) )

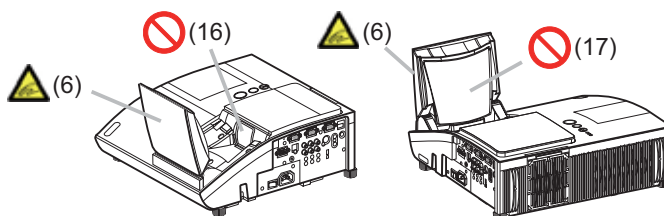
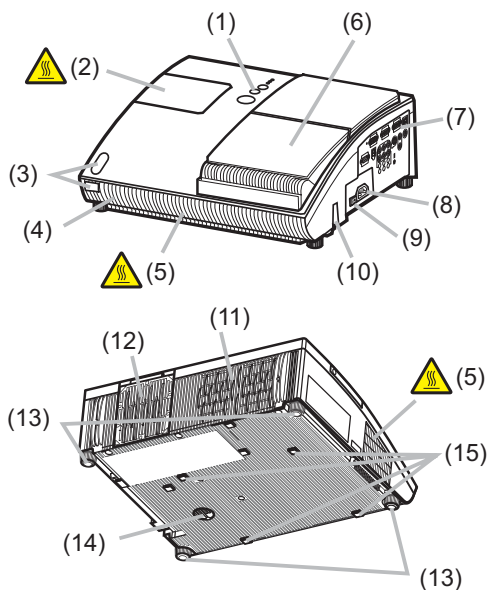

**⚠ WARNING** ▶ Be careful not to pinch your finger with the lens door, to prevent an injury.  
▶ Never look into the projection lens or mirror while the projection lamp lights, since the projection lamp ray may cause a trouble on your eyes.

**⚠ CAUTION** ▶ Do not touch the lamp cover or approach the exhaust vents while using the projector and for a while after use, to prevent a burn.  
▶ Do not cover, block, or plug up the vents to keep normal ventilation. Do not place anything that can stick or be sucked to the vents, around the intake vents.

## Control buttons

- (1) LAMP indicator (📖 69)
- (2) TEMP indicator (📖 69)
- (3) POWER indicator (📖 16, 17, 69)
- (4) STANDBY/ON button (📖 16, 17)
- (5) INPUT button (📖 18)
- (6) FOCUS +/- buttons  
when no menu is displayed (📖 21), or  
Cursor ◀, ▶ buttons  
when a menu is displayed (📖 24).
- (7) MENU buttons  
when no menu is displayed (📖 24), or  
Cursor ▲, ▼ buttons  
when a menu is displayed (📖 24).

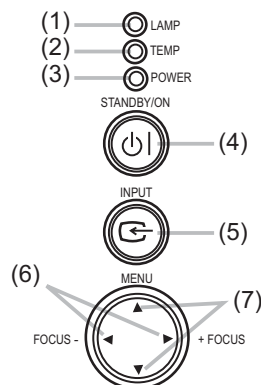

## Ports (📖 10, Technical's 3 to 6)

- (1) Shutdown switch
- (2) MONITOR OUT port
- (3) Y, C<sub>B</sub>/P<sub>B</sub>, C<sub>R</sub>/P<sub>R</sub> (Component video) ports
- (4) COMPUTER IN2 port
- (5) COMPUTER IN1 port
- (6) LAN port
- (7) CONTROL port
- (8) USB port (📖 15)
- (9) VIDEO port
- (10) AUDIO IN3 (L,R) ports (📖 37)
- (11) AUDIO OUT port
- (12) AUDIO IN1 port (📖 37)
- (13) AUDIO IN2 port (📖 37)
- (14) S-VIDEO port
- (15) Security slot (📖 13)

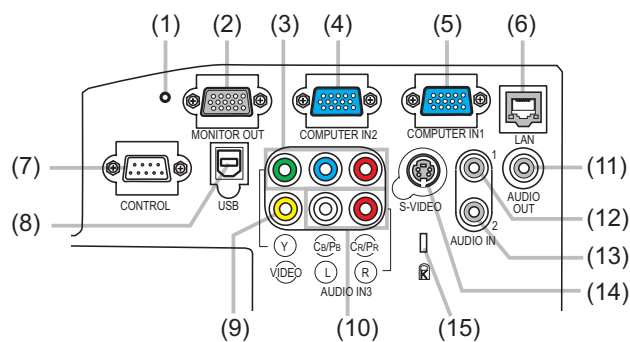

Part names

Remote control

- (1) STANDBY/ON button (16, 17)
- (2) VIDEO button (19)
- (3) COMPUTER button (18)
- (4) SEARCH button (19)
- (5) ASPECT button (19)
- (6) AUTO button (21)
- (7) BLANK button (23)
- (8) MAGNIFY ON button (22)
- (9) MAGNIFY OFF button (15, 22)
- (10) HOME button (15)
- (11) END button (15)
- (12) PAGE UP button (15)
- (13) PAGE DOWN button (15)
- (14) VOLUME button (18)
- (15) MUTE button (15, 18)
- (16) FREEZE button (23)
- (17) MY BUTTON 1 button (44)
- (18) MY BUTTON 2 button (44)
- (19) KEYSTONE button (22)
- (20) FOCUS – button (21)
- (21) FOCUS + button (21)
- (22) D-ZOOM – button (20)
- (23) D-ZOOM + button (20)
- (24) POSITION button (20, 22, 24)
- (25) MENU button (24)
- (26) Cursor ▲/▼/◀/▶ buttons (24, 25)
- (27) ENTER button (24, 25)
- (28) ESC button (24, 25)
- (29) RESET button (24, 25)
- (30) Battery cover (14)

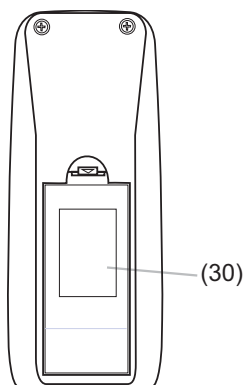
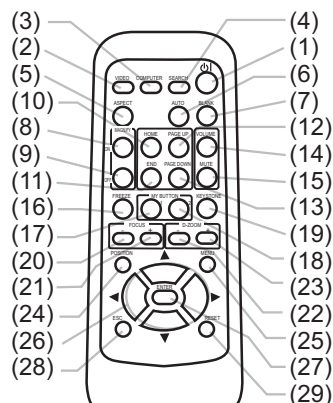

Back of the remote control

Setting up

**Arrangement**

Install the projector in a stable, cool, dry and airy place, keeping a space of 30 cm or more between the sides of the projector and other objects such as walls. Refer to the following to decide the projection style. Ceiling mount and tabletop use must be setup with the designated optional accessories. Ask your dealer for details.

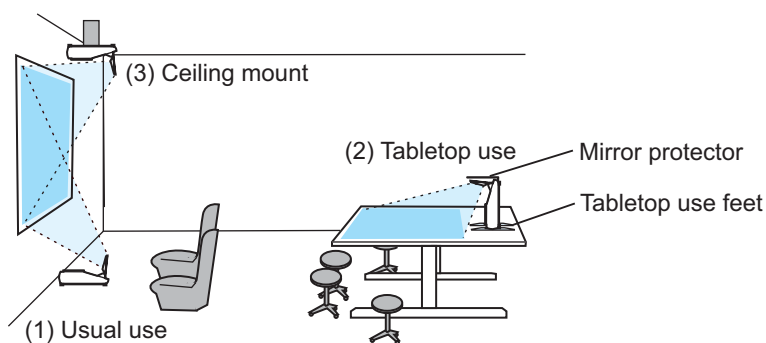

**NOTE** • When installing the projector, confirm that there is nothing that blocks the projection light between the projector and the screen.  
 • When installing the projector, check that the remote sensors are not exposed to any strong ray (🔗14).

**⚠ CAUTION** ► The designated optional accessory for the tabletop use contains the tabletop use feet and mirror protector. Please see the manual enclosed with the accessory.  
 • The tabletop use feet must be used for the tabletop use, otherwise the projector can't stand or falls down broken.  
 • The mirror protector must be used to protect the lens door when the projector falls to the table.

Setting up

Arrangement (continued)

Refer to the following for the projection distance.  
The values shown in the table are calculated for a full size screen: 1024x768.

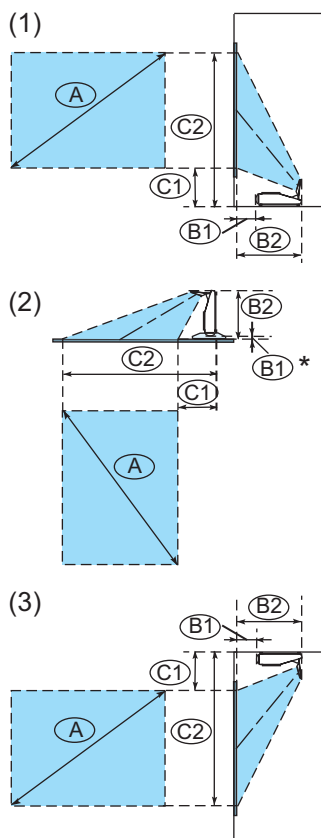

Table for 4:3 screen (±8%)

| (A)  | (B1)  |        | (B2)  |      | (C1) |      | (C2)  |      |
|------|-------|--------|-------|------|------|------|-------|------|
| inch | cm    | inch   | cm    | inch | cm   | inch | cm    | inch |
| 48   | * 0.5 | *(0.2) | 38.3  | 15   | 24.4 | 10   | 98.2  | 39   |
| 50   | 2     | 1      | 39.8  | 16   | 25.2 | 10   | 101.9 | 40   |
| 60   | 9.6   | 4      | 47.4  | 19   | 28.9 | 11   | 120.4 | 47   |
| 70   | 17.2  | 7      | 55    | 22   | 32.6 | 13   | 139.3 | 55   |
| 80   | 24.8  | 10     | 62.6  | 25   | 36.2 | 14   | 158.2 | 62   |
| 90   | 32.4  | 13     | 70.2  | 28   | 39.9 | 16   | 177.1 | 70   |
| 100  | 39.9  | 16     | 77.7  | 31   | 43.6 | 17   | 196   | 77   |
| 120  | 55    | 22     | 92.8  | 37   | 50.9 | 20   | 234   | 92   |
| 150  | 77.7  | 31     | 115.5 | 45   | 62   | 24   | 291   | 115  |
| 200  | 115.5 | 45     | 153.3 | 60   | 80.4 | 32   | 385.7 | 152  |

Table for 16:9 screen (±8%)

| (A)  | (B1)  |        | (B2)  |      | (C1)  |      | (C2)  |      |
|------|-------|--------|-------|------|-------|------|-------|------|
| inch | cm    | inch   | cm    | inch | cm    | inch | cm    | inch |
| 44   | * 0.5 | *(0.2) | 38.3  | 15   | 33.6  | 13   | 88.9  | 35   |
| 50   | 5.4   | 2      | 43.2  | 17   | 37.3  | 15   | 99.9  | 39   |
| 60   | 13.7  | 5      | 51.5  | 20   | 43.5  | 17   | 118.3 | 47   |
| 70   | 22.0  | 9      | 59.8  | 24   | 49.6  | 20   | 136.8 | 54   |
| 80   | 30.2  | 12     | 68.0  | 27   | 55.7  | 22   | 155.3 | 61   |
| 90   | 38.5  | 15     | 76.3  | 30   | 61.8  | 24   | 173.9 | 68   |
| 100  | 46.6  | 18     | 84.4  | 33   | 67.9  | 27   | 192.3 | 76   |
| 120  | 63.1  | 25     | 100.9 | 40   | 80.1  | 32   | 229.5 | 90   |
| 150  | 87.8  | 35     | 125.6 | 49   | 98.4  | 39   | 285.3 | 112  |
| 200  | 129.0 | 51     | 166.8 | 66   | 129.0 | 51   | 378.2 | 149  |

**NOTE** • It is recommended to adjust the screen size from 60 inch to 100 inch diagonal. The screen image adjusted out of this range, either smaller or larger, may be deteriorated.  
• The screen position may be shifted after installation if the projector is suspended on a ceiling or somewhere, since the body of this projector is made of plastics. If readjustment is necessary, consult with your dealer or installer.



**Arrangement (continued)**

**⚠ WARNING** ► Place the projector in a stable horizontal position. If the projector falls or is knocked over it could cause injury and/or damage to the projector. Using a damaged projector could then result in fire and/or electric shock.

- Do not place the projector on an unstable, slanted or vibrational surface such as a wobbly or inclined stand.
- Do not place the projector on its side or front position. To place the projector on its rear position for the table top use, it is required to use the designated optional parts. Consult with your dealer.
- Consult with your dealer before a special installation such as suspending from a ceiling or somewhere else.
- Place the projector in a cool place, and ensure that there is sufficient ventilation. The high temperature of the projector could cause fire, burns and/or malfunction of the projector.
- Do not stop-up, block or cover the projector's vents.
- Keep a space of 30 cm or more around the projector from other objects such as walls.
- Do not place the projector on metallic thing or anything weak in heat.
- Do not place the projector on carpet, cushions or bedding.
- Do not place the projector in direct sunlight or near hot objects such as heaters.
- Do not place anything near the lens door, lens, mirror, vents. or on the top of the projector.
- Do not place anything that may be sucked into or stick to the vents on the rear and bottom of the projector. This projector has some intake vents on the rear and bottom.
- Do not place the projector anyplace where it may get wet. Getting the projector wet or inserting liquid into the projector could cause fire, electric shock and/or malfunction of the projector.
- Do not place the projector in a bathroom or the outdoors.
- Do not place anything containing liquid near the projector.

**⚠ CAUTION** ► Avoid placing the projector in smoky, humid or dusty place. Placing the projector in such places could cause fire, electric shock and/or malfunction of the projector.

- Do not place the projector near humidifiers, smoking spaces or a kitchen.
- Position the projector to prevent light from directly hitting the projector's remote sensor.

Setting up

### Connecting with your devices

Before connecting them, make sure that the devices are suitable to connect with this projector, and prepare the required signal cables and adapters. Consult your dealer if the accessory that is not included in this product is required. Refer to the following for connection. If you want to use the cable cover, see the Using the cable cover (13).

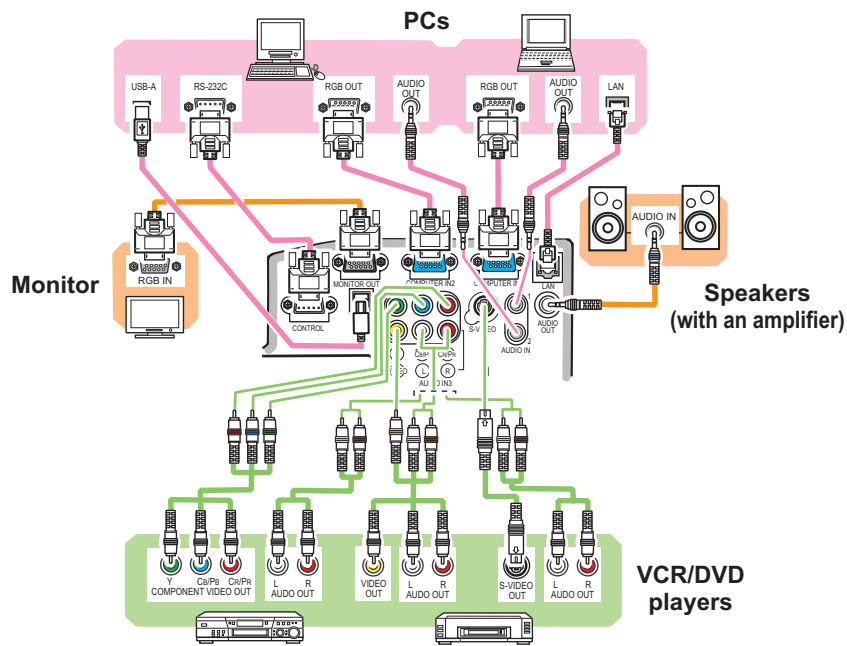

**⚠ WARNING** ▶ Use only the accessories contained in this product or recommended by your dealer. Do not modify the projector or accessories.  
 ▶ For the cable with a ferrite core only at one end, connect the end with the core to the projector. The cables may be required a specific length or a ferrite core by the regulations.  
 ▶ Be careful not to damage the cables. Route the cables so that they are not likely to be walked on or pinched by items placed upon or against them.  
**⚠ CAUTION** ▶ Do not connect or disconnect the projector with devices while they are connected to a power supply, except for the cases directed by the manuals.  
 ▶ Be careful not to set a connector into a wrong port or with a wrong way.

(continued on next page)

**Connecting your devices (continued)**

- NOTE** • Be sure to read the manuals for devices before connecting them to the projector, and make sure that all the devices are suitable to be connected with this product. Before connecting to a PC, check the signal level, the signal timing, and the resolution.
- Be sure to consult to the administrator of the network. Do not connect LAN port to any network that might have the excessive voltage.
  - Some signal may need an adapter to input this projector.
  - Some PCs have multiple screen display modes that may include some signals which are not supported by this projector.
  - Although the projector can display signals with resolution up to UXGA (1600X1200), the signal will be converted to the projector's panel resolution before being displayed. The best display performance will be achieved if the resolutions of the input signal and the projector panel are identical.
  - While connecting, make sure that the shape of the cable's connector fits the port to connect with. And be sure to tighten the screws on connectors with screws.
  - When connecting a laptop PC to the projector, be sure to activate the PC's external RGB output. (Set the laptop PC to CRT display or to simultaneous LCD and CRT display.) For details on how this is done, please refer to the instruction manual of the corresponding laptop PC.
  - When the picture resolution is changed on a PC depending on an input, automatic adjustment function may take some time and may not be completed. In this case, you may not be able to see a check box to select "Yes/No" for the new resolution on Windows. Then the resolution will go back to the original. It might be recommended to use other CRT or LCD monitors to change the resolution.
  - In some cases, this projector may not display a proper picture or display any picture on screen. For example, automatic adjustment may not function correctly with some input signals. An input signal of composite sync or sync on G may confuse this projector, so the projector may not display a proper picture.

**About Plug-and-Play capability**

Plug-and-Play is a system composed of a PC, its operating system and peripheral equipment (i.e. display devices). This projector is VESA DDC 2B compatible. Plug-and-Play can be used by connecting this projector to a PC that is VESA DDC (display data channel) compatible.

- Take advantage of this feature by connecting an RGB cable to the COMPUTER IN1 port (DDC 2B compatible). Plug-and-Play may not work properly if any other type of connection is attempted.
- Please use the standard drivers in your PC as this projector is a Plug-and-Play monitor.

Setting up

### Connecting with a power supply

Before connection, confirm that the power outlet is suitable for this projector and the power cord. Then follow the procedure below for connection.

1. Insert the end of the power cord with the socket into the AC inlet of the projector.
2. Plug the other end of the power cord into a power outlet.

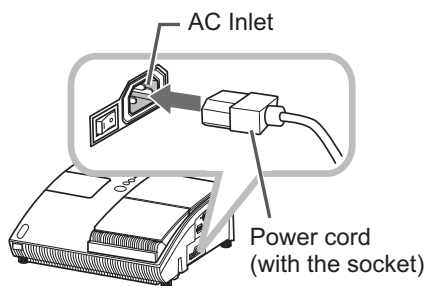

**⚠ WARNING** ► Be careful of operation for a power supply not to cause an electric shock or a fire.

- Do not handle the power cord with the wet hand.
- Use this product with only the type of power supply indicated on the projector.
- Use a power outlet that is close to the projector and easily accessible.
- Connect firmly the power cord not to result in loose connection. Do not use a loose or unsound power outlet.
- Do not overload the outlet, since overloading can result in a risk of fire or electric shock.
- Use only the power cord contained in this product unless it is damaged. If it is damaged, consult your dealer to get new one. Do not modify the power cord.

## Using the security bar and slot

This projector has the security bar for a commercial anti-theft chain or wire up to 10 mm in diameter, and also the security slot for the Kensington lock.

For details, see the manual of the security tool.

**NOTE** • These are not provided as comprehensive theft preventions but supplemental measures.

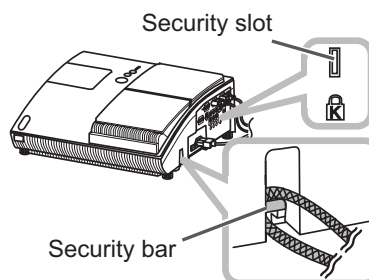

**⚠ WARNING** ► Do not place the anti-theft chain or wire near the projector's exhaust vents, since the chain or wire heated by the hot exhaust gas may cause a burn.

► Do not use the security bar or slot for the purpose of fall prevention, since these are not designed for it.

## Using the cable cover

Utilize the cable cover as the guard and blind for the connecting parts.

1. Connect the signal cables and the power cord to the projector first.
2. Attach the cable cover to the projector, uniting the interlocking parts.
3. Tighten the screw to fix the cable cover.
4. Connect the other ends of the cables to other devices, and plug the power cord to the power outlet.

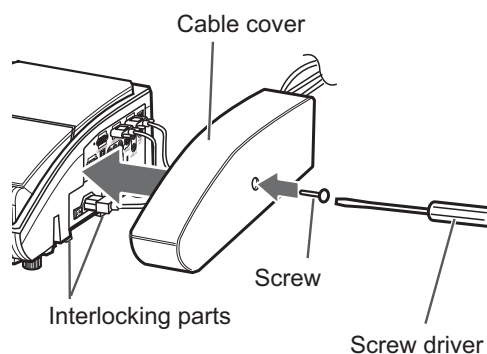

**⚠ CAUTION** ► Be careful not to pinch the cables in the cable cover, to prevent damage to the cables.

Remote control

Remote control

**Preparing for the remote control**

The accessory remote control needs batteries. Use the batteries included in this product or two new batteries of the specified type: **HITACHI MAXELL**, part number **LR6** or **R6P**. Follow the following procedure.

1. Remove the battery cover in the back of the remote control.
2. Put the batteries into the battery holder, according to the polarity markings (+) and (-) inside the holder.
3. Put the battery cover back to the former state.

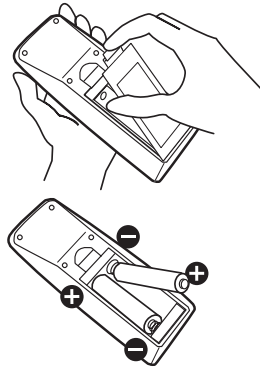

**NOTE** • Try changing the batteries when the remote control malfunctions.  
 • This remote control works with the remote sensors on the projector using infrared light (Class 1 LED). The active sensor senses the remote control signal assigned within 60 degrees to right and left, and within 3 meters.  
 • The remote control signal reflected in the screen or the like may be available.  
 • Prevent the remote sensors from being hit by a strong ray. It may cause malfunction of the projector and remote control.

Remote sensors

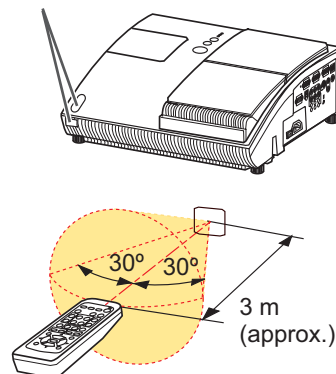

**⚠ WARNING** ► Be careful of handling a battery, as a battery can cause explosion, cracking or leakage, which could result in a fire, an injury, and environment pollution.  
 • Use only the specified and new battery. Do not use a battery with damage, such as a scratch, a dent, rust or leakage. Do not mix a new battery with used one.  
 • When a battery leaked, wipe the leakage out well with a waste cloth. If the leakage adhered to your body, immediately rinse it well with water. When a battery leaked in the battery holder, replace the batteries after wiping the leakage out.  
 • Make sure the plus and minus terminals are correctly aligned when loading a battery.  
 • Do not work on a battery; for example recharging or soldering.  
 • Do not keep the batteries put into the remote control when the remote control is not used for a long while. Keep a battery in a dark, cool and dry place. Never expose a battery to a fire or water.  
 • Obey the local laws on disposing a battery.

## Changing the frequency of remote control signal

The accessory remote control has the two choices on signal frequency Mode 1:NORMAL and Mode 2:HIGH. If the remote control does not function properly, attempt to change the signal frequency. In order to set the Mode, please keep pressing the combination of two buttons listed below simultaneously for about 3 seconds.

- (1) Set to Mode 1:NORMAL... **MUTE** and **RESET** buttons
- (2) Set to Mode 2:HIGH... **MAGNIFY OFF** and **ESC** buttons

Please remember that the REMOTE FREQ. in the SERVICE item of the OPTION menu (46) of the projector to be controlled should be set to the same mode as the remote control.

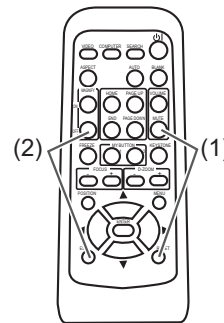

## Using as a simple PC mouse & keyboard

The accessory remote control works as a simple mouse and keyboard of the PC, when the projector's USB port (B type) connects with the PC's USB port (A type) port via a mouse cable.

- (1) **HOME key:** Press **HOME** button.
- (2) **END key:** Press **END** button.
- (3) **PAGE UP key:** Press **PAGE UP** button.
- (4) **PAGE DOWN key:** Press **PAGE DOWN** button.
- (5) **Mouse left button:** Press **ENTER** button.
- (6) **Move pointer:** Use the cursor buttons **▲**, **▼**, **◀** and **▶**.
- (7) **ESC key:** Press **ESC** button.
- (8) **Mouse right button:** Press **RESET** button.

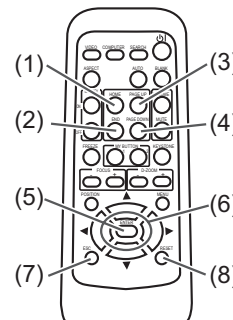
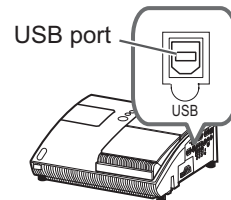

**⚠ WARNING** ▶ Improper use of the simple mouse & keyboard function could damage your equipment. While using this function, please connect this product only to a PC. Be sure to check your PC's manuals before connecting this product to the PC.

**NOTE** • When the simple mouse & keyboard function of this product does not work correctly, please check the following.

- When a USB cable connects this projector with a PC having a built-in pointing device (e.g. track ball) like a notebook PC, open BIOS setup menu, then select the external mouse and disable the built-in pointing device, because the built-in pointing device may have priority to this function.
- Windows 95 OSR 2.1 or higher is required for this function. And also this function may not work depending on the PC's configurations and mouse drivers.
- You cannot do things like press two buttons at once (for instance, pressing two buttons at the same time to move the mouse pointer diagonally).
- This function is activated only when the projector is working properly. This function is not available while the lamp is warming up (the **POWER** indicator blinks green), and while adjusting the volume and display, correcting for keystone, magnifying the screen, using the BLANK function, or displaying the menu screen.

Power on/off

Power on/off

**Turning on the power**

Turn on the projector and the connected devices. Turn on the projector ahead of other connected devices, unless mentioned in the manuals. For this projector, follow the procedure below.

1. Press the side marked "I" of the power switch, as the power-on position. The **POWER** indicator lights up in orange.
  - For a couple of seconds after the **POWER** indicator lights up, wait to use the control buttons (on the projector and remote control). The buttons may not work soon.
2. Confirm that there is nothing that the lens door hits while opening. Then, press the **STANDBY/ON** button (on the projector or remote control). The lens door opens, the projection lamp lights up, and the **POWER** indicator begins to blink green.

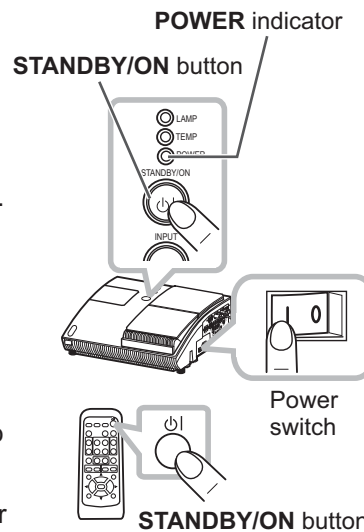

When the projector starts completely, the indicator will turn steady green.

To display the picture, select an input signal according to the section "Selecting an input signal" (18).

**NOTE** • When the AUTO ON of the OPTION menu is set to the TURN ON, and the power was turned off by the power switch last time, turning the power switch on makes the projection lamp light on without pushing the **STANDBY/ON** button (42).

**⚠ WARNING** ▶ Never look into the projection lens or mirror while the projection lamp lights, since the projection lamp ray may cause a trouble on your eyes.  
 ▶ Do not touch around the lamp cover and the exhaust vents during use or just after use, since it is too hot.

**⚠ CAUTION** ▶ Be careful not to pinch your finger with the lens door, as it may cause an injury.



## Turn off the power

Turn the projector off after turning off the other connected devices, unless mentioned in the manuals. For this projector, follow the procedure below.

1. Press the **STANDBY/ON** button (on the projector or remote control).  
The "Power off?" dialog appears on the screen for about 5 seconds.
2. Confirm that there is nothing that the lens door hits while closing.  
Then press the **STANDBY/ON** button again while the message appears.  
The projection lamp goes off, the lens door closes, and the **POWER** indicator begins to blink orange.
  - For cooling the projector down, wait for the **POWER** indicator to stop blinking and turn steady orange.  
The projector can be turned off without waiting for cooling down. However, the manufacture recommends cooling the projector down enough.  
Do not turn the projector on for about 10 minutes or more after turning it off to prevent shortening its life.

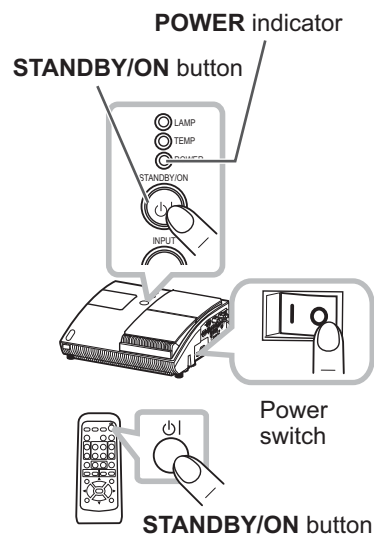

3. Press the side marked "○" of the power switch, as the power-off position.  
The **POWER** indicator goes off.

When you will not use the projector for a long while, unplug and separate the power cord from the power outlet, for safety purposes.

**NOTE** • Use the shutdown switch (🔒70) only when the projector is not turned off by normal procedure.  
• Do not turn the projector on for about 10 minutes or more after turning it off. Turning the projector on again too soon could shorten the lifetime of some consumable parts of the projector.

**⚠ CAUTION** ▶ Be careful not to pinch your finger with the lens door, to prevent an injury.  
▶ Do not touch the lamp cover or approach the exhaust vents while using the projector and for a while after use, to prevent a burn.

Operating

Operating

### Adjusting the volume

1. Press **VOLUME** button on the remote control.
  - A dialog will appear on the screen to aid you in adjusting the volume.
2. Use the **▲/▼** cursor buttons to adjust the volume.
  - To close the dialog and complete the operation, press the **VOLUME** button again. Even if you do not do anything, the dialog will automatically disappear after a few seconds.
  - When **X** is selected for current picture input port, the volume adjustment is disable. Please see AUDIO item of SETUP menu (437).

VOLUME button

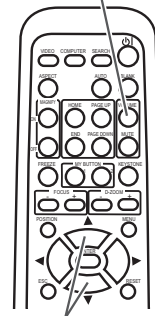

▲/▼ button

### Temporarily muting the sound

1. Press **MUTE** button on the remote control.
  - A dialog will appear on the screen indicating that you have muted the sound. To restore the sound, press the **MUTE** or **VOLUME** button. Even if you do not do anything, the dialog will automatically disappear after a few seconds.
  - When **X** is selected for current picture input port, the sound is always muted. Please see AUDIO item of SETUP menu (437).
  - When **X** is selected to VIDEO, S-VIDEO or COMPONENT port, the C.C. (Closed Caption) is automatically activated if the C.C. is set to AUTO in the DISPLAY of the C.C. menu and the input signal from the port supports the C.C. feature (460).

MUTE button

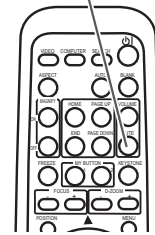

### Selecting an input signal

1. Press **INPUT** button on the projector.
  - Each time you press the button, the projector switches its input port from the current port as below.
    - COMPUTER IN 1 → COMPUTER IN 2
    - ← VIDEO ← S-VIDEO ← COMPONENT (Y, Cb/Pb, Cr/Pr) ←
  - While TURN ON is selected for AUTO SEARCH item in OPTION menu (442), the projector will keep checking the ports in above order repeatedly till an input signal is detected.

INPUT button

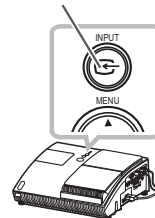

1. Press **COMPUTER** button on the remote control.
  - Each time you press the button, the projector switches its input port from the current port as below.

COMPUTER IN 1 ↔ COMPUTER IN 2

- While TURN ON is selected for AUTO SEARCH item in OPTION menu, the projector will keep checking every port sequentially till an input signal is detected (442). If **COMPUTER** button is pushed when VIDEO, S-VIDEO or COMPONENT port is selected, the projector will check COMPUTER IN1 port first.

COMPUTER button

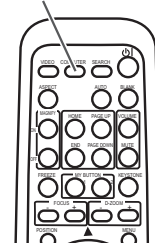

(continued on next page)

Operating

**Selecting an input signal (continued)**

1. Press **VIDEO** button on the remote control.
  - Each time you press the button, the projector switches its input port from the current port as below.

COMPONENT (Y, Cb/Pb, Cr/Pr) → S-VIDEO → VIDEO



- While **TURN ON** is selected for **AUTO SEARCH** item in **OPTION** menu, the projector will keep checking every port sequentially till an input signal is detected (42). If **VIDEO** button is pushed when **COMPUTER IN1** or **COMPUTER IN2** port is selected, the projector will check **COMPONENT** port first.

**VIDEO** button

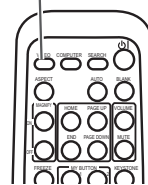

**Searching an input signal**

1. Press **SEARCH** button on the remote control.
  - The projector will start to check its input ports as below in order to find any input signals. When an input is found, the projector will stop searching and display the image. If no signal is found, the projector will return to the state selected before the operation.

COMPUTER IN 1 → COMPUTER IN 2 → VIDEO ← S-VIDEO ← COMPONENT (Y, Cb/Pb, Cr/Pr) ←

- While **TURN ON** is selected for **AUTO SEARCH** item in **OPTION** menu (42), the projector will keep checking the ports in above order repeatedly till an input signal is detected.

**SEARCH** button

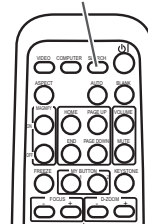

**Selecting an aspect ratio**

1. Press **ASPECT** button on the remote control.
  - Each time you press the button, the projector switches the mode for aspect ratio in turn.

○ **For a computer signal**  
NORMAL → 4:3 → 16:9



○ **For a video signal, s-video signal or component video signal**  
4:3 → 16:9 → 14:9



○ **For no signal**  
4:3 (fixed)

- **ASPECT** button does not work when no proper signal is inputted.
- **NORMAL** mode keeps the original aspect ratio setting.

**ASPECT** button

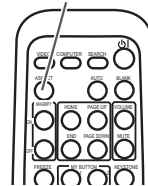

Operating

### Adjusting the projection position

This projector has four elevator feet in the bottom. Use them to adjust the projection position.

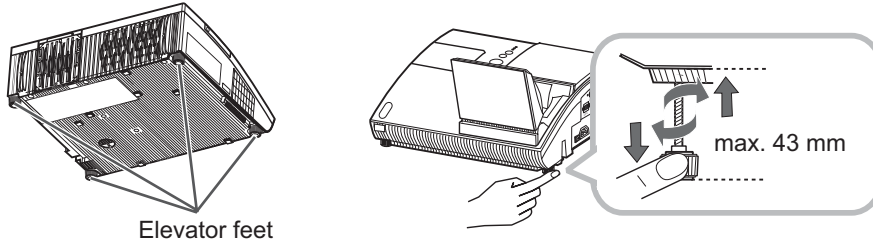

Elevator feet

**⚠ CAUTION** ▶ Do not lengthen the elevator feet to 43 mm or more. The foot lengthened exceeding the limit may come off from the projector, and result in an injury.  
 ▶ Tilt the projector with these elevating feet only.  
 ▶ Do not tilt the projector over 5 degrees, when it is suspended from a ceiling or somewhere.

### Adjusting the zoom

Press the **D-ZOOM +** or **D-ZOOM –** button on the remote control to display D-ZOOM dialog on screen.

Use the **D-ZOOM +** and **D-ZOOM –** buttons to adjust the picture size.

To finish the operation, do not touch these buttons for a few seconds until the dialog is disappeared.

- If you want to expand a part of the image, use the magnify function (🔍22).

**D-ZOOM +** button

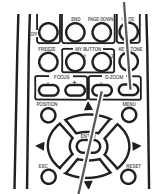

**D-ZOOM –** button

### Adjusting the picture position

Press the **POSITION** button on the remote control while no menu is on screen, to display the D-SHIFT dialog on screen.

Use the **▲**, **▼**, **◀** and **▶** buttons to adjust the picture position. Press the **POSITION** button again to finish this operation.

- This is a function to shift the position of the shrunken picture by the zoom function.
- The function is not available, if any menu is displayed on screen.
- The function is not available, if the D-ZOOM is adjusted to 100 (full screen) on its dialog.

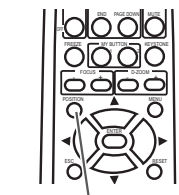

**POSITION** button

## Adjusting the focus

Press the **FOCUS +** or **FOCUS –** button on the remote control, or **FOCUS +** or **FOCUS –** button on the projector while no menu is on screen, to display the FOCUS box on screen. Use the **FOCUS +** and **FOCUS –** buttons to adjust the screen focus. After the focus adjustment, wait for a while until the FOCUS box is disappeared, if you want to display any other menu on screen by pushing the **MENU** button on the projector.

**FOCUS +** button

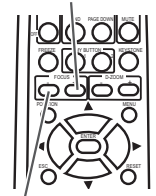

**FOCUS –** button

## Using the automatic adjustment feature

1. Press **AUTO** button on the remote control.
- Pressing this button performs the following.

- **For a computer signal**

The vertical position, the horizontal position and the horizontal phase will be automatically adjusted. Make sure that the application window is set to its maximum size prior to attempting to use this feature. A dark picture may still be incorrectly adjusted. Use a bright picture when adjusting.

- **For a video signal and s-video signal**

The video format best suited for the respective input signal will be selected automatically. This function is available only when the AUTO is selected for the VIDEO FORMAT item in the INPUT menu (34). The vertical position and horizontal position will be automatically set to the default.

- **For a component video signal**

The vertical position, horizontal position and horizontal phase will be automatically set to the default.

- The automatic adjustment operation requires approx. 10 seconds. Also please note that it may not function correctly with some input. When this function is performed for a video signal, a certain extra such as a line may appear outside a picture.
- The items adjusted by this function may vary when the FINE or DISABLE is selected for the AUTO ADJUST item of the SERVICE item in the OPTION menu (45).

**AUTO** button

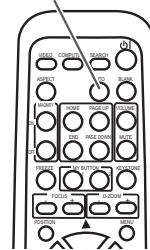

Operating

### Correcting the keystone distortions

1. Press **KEYSTONE** button on the remote control. A dialog will appear on the screen to aid you in correcting the distortion.
2. Use the **▲/▼** cursor buttons to adjust the keystone correction.



KEYSTONE button

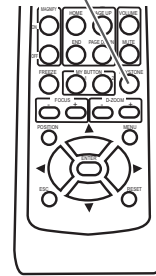

To close the dialog and complete this operation, press **KEYSTONE** button again. Even if you do not do anything, the dialog will automatically disappear after a few seconds.

- The adjustable range of this correction will vary among inputs. For some input, this function may not work well.
- This function will be unavailable when Transition Detector is on (51).

### Using the magnify feature

1. Press the **ON** button of **MAGNIFY** on the remote control. The “MAGNIFY” indication will appear on the screen and the projector will go into the MAGNIFY mode. When the **ON** button of **MAGNIFY** is pressed first after the projector is started, the picture will be zoomed twice. The indication will disappear in several seconds with no operation.
2. Use the **▲/▼** cursor buttons to adjust the zoom level. The picture of video, s-video or component video signal can be zoomed in up to 2 times, and the one of computer signal can be zoomed in up to 4 times. To move the zoom area, press the **POSITION** button in the MAGNIFY mode, then use the **▲/▼/◀/▶** cursor buttons to move the area. And to finalize the zoom area, press the **POSITION** button again. To exit from the MAGNIFY mode and restore the screen to normal, press the **OFF** button of **MAGNIFY** on the remote control.

MAGNIFY ON/OFF button

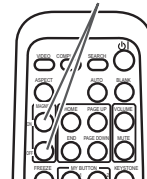

- The projector automatically exits from the MAGNIFY mode when the input signal is changed or when the display condition is changed.
- In the MAGNIFY mode, the keystone distortion condition may vary, it will be restored when the projector exits from the MAGNIFY mode.

**NOTE** • The zoom level can be finely adjusted. Closely watch the screen to find the level you want.

## Freezing the screen

1. Press the **FREEZE** button on the remote control.
  - The “FREEZE” indication will appear on the screen (however, the indication will not appear when the TURN OFF is selected for the MESSAGE item in the SCREEN menu (41)), and the projector will go into the FREEZE mode, which the picture is frozen.
  - To exit the FREEZE mode and restore the screen to normal, press the **FREEZE** button again.

FREEZE button

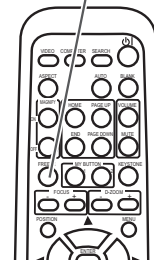

- The projector automatically exits from the FREEZE mode when one of the projector’s buttons or remote control buttons of STANDBY/ON, SEARCH, COMPUTER, VIDEO, BLANK, AUTO, VOLUME, MUTE, KEYSTONE, MENU, MAGNIFY and MY BUTTON1/2 (except MY MEMORY or PICTURE MODE is assigned to) (44) is pressed.
- If the projector continues projecting a still image for a long time, the LCD panel might possibly be burned in. Do not leave the projector in the FREEZE mode for too long.

## Temporarily blanking the screen

1. Press **BLANK** button on the remote control.
  - The BLANK screen will be displayed instead of the screen of input signal. Please refer to BLANK item in SCREEN menu (38).
  - To exit from the BLANK screen and return to the input signal screen, press **BLANK** button again.
- The projector automatically returns to the input signal screen when one of the projector’s buttons or the remote control buttons (except ASPECT, POSITION, MAGNIFY or FREEZE button, also except MY BUTTON1/2 if MY MEMORY or PICTURE MODE is assigned to) (44) is pressed.

BLANK button

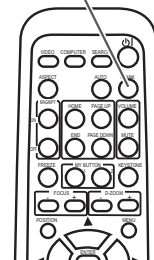

**NOTE** • The sound is not connected with the BLANK screen function.  
If necessary, set the volume or mute first.

- If you want to make the screen blank and the sound muted at the same time, use AV Mute function that is required to be assigned to one of the My Button on the remote in advance (44).

**Operating**

**Using the menu function**

This projector has the following menus:

PICTURE, IMAGE, INPUT, SETUP, SCREEN, OPTION, NETWORK, C.C. and EASY MENU.

EASY MENU consists of functions often used, and the other menus are classified into each purpose and brought together as the Advanced Menu.

Each of these menus is operated using the same methods. The basic operations of these menus are as follows.

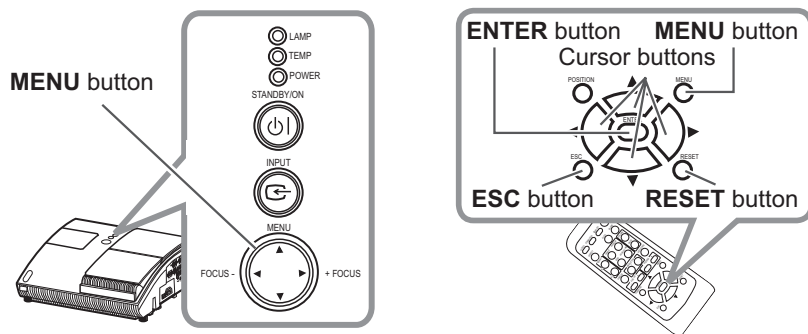

1. Press the **MENU** button on the remote control or the projector. The Advanced Menu or EASY MENU, which has priority just after powered on will appear. If you want to move the menu position, use the cursor buttons after pressing the **POSITION** button. While the projector is displaying any menu, the **MENU** button on the projector works as the cursor buttons.

**In the EASY MENU**

2. If you want to change it to the Advanced Menu, select the Go to Advanced Menu...
3. Use the ▲/▼ cursor buttons to select an item to operate.
4. Use the ◀/▶ cursor buttons to operate the item.



EASY MENU

(continued on next page)



**Using the menu function (continued)**

**In the Advanced Menu**

2. Use the ▲/▼ cursor buttons to select a menu. If you want to change it to the EASY MENU, select EASY MENU. Then press the ► cursor button, or **ENTER** button to select an item. The lower layer menu of the selected item will appear.



Advanced Menu

3. Use the ▲/▼ cursor buttons to select an item to operate. Then press the ► cursor button, or **ENTER** button to progress. The operation menu of the selected item will appear.
4. Use the ▲/▼ cursor buttons to operate the item.
  - Some functions cannot be performed when a certain input port is selected, or when a certain input signal is displayed.
  - When you want to reset the operation, press **RESET** button on the remote control during the operation. Note that some items (ex. LANGUAGE, H PHASE, VOLUME) cannot be reset.
  - In the Advanced Menu, when you want to return to the previous display, press the ◀ cursor button or **ESC** button on the remote control.
5. Press **MENU** button on the remote control again to close the menu and complete this operation. Even if you do not do anything, the dialog will automatically disappear after about 10 seconds.

EASY MENU

EASY MENU

From the EASY MENU, items shown in the table below can be performed.

Select an item using the ▲/▼ cursor buttons. Then perform it according to the following table.



| Item                | Description  |            |            |       |        |                |            |        |                |            |         |                 |            |              |                        |            |              |                        |            |            |                |            |         |                        |            |
|---------------------|--|------------|------------|-------|--------|----------------|------------|--------|----------------|------------|---------|-----------------|------------|--------------|------------------------|------------|--------------|------------------------|------------|------------|----------------|------------|---------|------------------------|------------|
| <b>ASPECT</b>       | Using the ◀/▶ buttons switches the mode for aspect ratio. See the ASPECT item in IMAGE menu (📖31).   |            |            |       |        |                |            |        |                |            |         |                 |            |              |                        |            |              |                        |            |            |                |            |         |                        |            |
| <b>D-ZOOM</b>       | Using the ◀/▶ buttons adjusts the zoom. See the D-ZOOM item in SETUP menu (📖36).   |            |            |       |        |                |            |        |                |            |         |                 |            |              |                        |            |              |                        |            |            |                |            |         |                        |            |
| <b>KEYSTONE</b> [↙] | Using the ◀/▶ buttons corrects the vertical keystone distortion. See KEYSTONE [↙] item in SETUP menu (📖36).  |            |            |       |        |                |            |        |                |            |         |                 |            |              |                        |            |              |                        |            |            |                |            |         |                        |            |
| <b>PICTURE MODE</b> | <p>Using the ◀/▶ buttons switches the picture mode. The picture modes are combinations of GAMMA and COLOR TEMP settings. Choose a suitable mode according to the projected source.</p> <p>                     ↻ NORMAL ↔ CINEMA ↔ DYNAMIC ↔ BOARD(BLACK) ↻<br/>                     ↻ DAYTIME ↔ WHITEBOARD ↔ BOARD(GREEN) ↻                 </p> <table border="1"> <thead> <tr> <th></th> <th>COLOR TEMP</th> <th>GAMMA</th> </tr> </thead> <tbody> <tr> <td>NORMAL</td> <td>#2 MID DEFAULT</td> <td>#1 DEFAULT</td> </tr> <tr> <td>CINEMA</td> <td>#3 LOW DEFAULT</td> <td>#2 DEFAULT</td> </tr> <tr> <td>DYNAMIC</td> <td>#1 HIGH DEFAULT</td> <td>#3 DEFAULT</td> </tr> <tr> <td>BOARD(BLACK)</td> <td>#4 Hi-BRIGHT-1 DEFAULT</td> <td>#4 DEFAULT</td> </tr> <tr> <td>BOARD(GREEN)</td> <td>#5 Hi-BRIGHT-2 DEFAULT</td> <td>#4 DEFAULT</td> </tr> <tr> <td>WHITEBOARD</td> <td>#2 MID DEFAULT</td> <td>#5 DEFAULT</td> </tr> <tr> <td>DAYTIME</td> <td>#6 Hi-BRIGHT-3 DEFAULT</td> <td>#6 DEFAULT</td> </tr> </tbody> </table> <ul style="list-style-type: none"> <li>• When the combination of GAMMA and COLOR TEMP differs from pre-assigned modes above, the display on the menu for the PICTURE MODE is “CUSTOM”. Please refer to GAMMA (📖28) and COLOR TEMP (📖29) items in PICTURE menu.</li> <li>• When this function is performed, a certain extra such as a line may appear.</li> </ul> |            | COLOR TEMP | GAMMA | NORMAL | #2 MID DEFAULT | #1 DEFAULT | CINEMA | #3 LOW DEFAULT | #2 DEFAULT | DYNAMIC | #1 HIGH DEFAULT | #3 DEFAULT | BOARD(BLACK) | #4 Hi-BRIGHT-1 DEFAULT | #4 DEFAULT | BOARD(GREEN) | #5 Hi-BRIGHT-2 DEFAULT | #4 DEFAULT | WHITEBOARD | #2 MID DEFAULT | #5 DEFAULT | DAYTIME | #6 Hi-BRIGHT-3 DEFAULT | #6 DEFAULT |
|                     | COLOR TEMP   | GAMMA      |            |       |        |                |            |        |                |            |         |                 |            |              |                        |            |              |                        |            |            |                |            |         |                        |            |
| NORMAL              | #2 MID DEFAULT   | #1 DEFAULT |            |       |        |                |            |        |                |            |         |                 |            |              |                        |            |              |                        |            |            |                |            |         |                        |            |
| CINEMA              | #3 LOW DEFAULT   | #2 DEFAULT |            |       |        |                |            |        |                |            |         |                 |            |              |                        |            |              |                        |            |            |                |            |         |                        |            |
| DYNAMIC             | #1 HIGH DEFAULT  | #3 DEFAULT |            |       |        |                |            |        |                |            |         |                 |            |              |                        |            |              |                        |            |            |                |            |         |                        |            |
| BOARD(BLACK)        | #4 Hi-BRIGHT-1 DEFAULT   | #4 DEFAULT |            |       |        |                |            |        |                |            |         |                 |            |              |                        |            |              |                        |            |            |                |            |         |                        |            |
| BOARD(GREEN)        | #5 Hi-BRIGHT-2 DEFAULT   | #4 DEFAULT |            |       |        |                |            |        |                |            |         |                 |            |              |                        |            |              |                        |            |            |                |            |         |                        |            |
| WHITEBOARD          | #2 MID DEFAULT   | #5 DEFAULT |            |       |        |                |            |        |                |            |         |                 |            |              |                        |            |              |                        |            |            |                |            |         |                        |            |
| DAYTIME             | #6 Hi-BRIGHT-3 DEFAULT   | #6 DEFAULT |            |       |        |                |            |        |                |            |         |                 |            |              |                        |            |              |                        |            |            |                |            |         |                        |            |

(continued on next page)

**EASY MENU (continued)**

| Item                          | Description  |
|-------------------------------|--|
| <b>BRIGHTNESS</b>             | Using the ◀/▶ buttons adjusts the brightness.<br>See BRIGHTNESS item in PICTURE menu ( <a href="#">p28</a> ).  |
| <b>CONTRAST</b>               | Using the ◀/▶ buttons adjusts the contrast.<br>See CONTRAST item in PICTURE menu ( <a href="#">p28</a> ).  |
| <b>COLOR</b>                  | Using the ◀/▶ buttons adjusts the strength of whole color.<br>See COLOR item in PICTURE menu ( <a href="#">p29</a> ).  |
| <b>TINT</b>                   | Using the ◀/▶ buttons adjusts the tint.<br>See TINT item in PICTURE menu ( <a href="#">p29</a> ).  |
| <b>SHARPNESS</b>              | Using the ◀/▶ buttons adjusts the sharpness.<br>See SHARPNESS item in PICTURE menu ( <a href="#">p30</a> ).  |
| <b>WHISPER</b>                | Using the ◀/▶ buttons turns off/on the whisper mode.<br>See WHISPER item in SETUP menu ( <a href="#">p36</a> ).  |
| <b>MIRROR</b>                 | Using the ◀/▶ buttons switches the mode for mirror status.<br>See MIRROR item in SETUP menu ( <a href="#">p36</a> ).   |
| <b>RESET</b>                  | Performing this item resets all of EASY MENU items except FILTER TIME and LANGUAGE.<br>Pressing the RESET button or the ▶ button displays a dialog. To reset, select RESET using the ▲ button performs resetting.  |
| <b>FILTER TIME</b>            | The usage time of the air-filter is shown in the menu.<br>Performing this item resets the filter time which counts usage time of the air-filter.<br>Pressing the RESET button or the ▶ button displays a dialog. To reset the filter time, select RESET using the ▲ button performs resetting.<br>See FILTER TIME item in OPTION menu ( <a href="#">p43</a> ). |
| <b>LANGUAGE</b>               | Using the ◀/▶ buttons changes the display language.<br>See LANGUAGE item in SCREEN menu ( <a href="#">p38</a> ).   |
| <b>Go to Advanced Menu...</b> | Select Go to Advanced Menu... on the menu, and press the ▶ or <b>ENTER</b> button to use the menu of PICTURE, IMAGE, INPUT, SETUP, SCREEN, OPTION, NETWORK or C.C..  |

**PICTURE menu**

**PICTURE menu**

From the PICTURE menu, items shown in the table below can be performed. Select an item using the ▲/▼ cursor buttons, and press the ► cursor button or **ENTER** button to execute the item. Then perform it according to the following table.



| Item              | Description  |
|-------------------|--|
| <b>BRIGHTNESS</b> | Using the ▲/▼ buttons adjusts the brightness.<br>Light ⇔ Dark  |
| <b>CONTRAST</b>   | Using the ▲/▼ buttons adjusts the contrast.<br>Strong ⇔ Weak   |
| <b>GAMMA</b>      | <p>Using the ▲/▼ buttons switches the gamma mode.<br/>                     #1 DEFAULT ⇔ #1 CUSTOM ⇔ #2 DEFAULT ⇔ #2 CUSTOM<br/>                     ⇕ ⇕<br/>                     #6 CUSTOM #3 DEFAULT<br/>                     ⇕ ⇕<br/>                     #6 DEFAULT #3 CUSTOM<br/>                     ⇕ ⇕<br/>                     #5 CUSTOM ⇔ #5 DEFAULT ⇔ #4 CUSTOM ⇔ #4 DEFAULT</p> <p><b>To adjust CUSTOM</b></p> <p>Selecting a mode whose name includes CUSTOM and then pressing the ► button or the <b>ENTER</b> button displays a dialog to aid you in adjusting the mode. This function is useful when you want to change the brightness of particular tones.</p>  <p>Choose an item using the ◀/▶ buttons, and adjust the level using the ▲/▼ buttons. You can display a test pattern for checking the effect of your adjustment by pressing the <b>ENTER</b> button. Each time you press the <b>ENTER</b> button, the pattern changes as below.</p> <p>No pattern ⇒ Gray scale of 9 steps ⇐<br/>                     ⇑ Ramp ⇐ Gray scale of 15 steps</p> <p>The eight equalizing bars correspond to eight tone levels of the test pattern (Gray scale of 9 steps), except the darkest in the left end. If you want to adjust the 2nd tone from left end on the test pattern use the equalizing adjustment bar "1". The darkest tone at the left end of the test pattern cannot be controlled with any of equalizing adjustment bar.</p> <ul style="list-style-type: none"> <li>• When this function is performed, lines or other distortion may appear.</li> </ul> |

(continued on next page)

PICTURE menu (continued)

| Item                     | Description   |
|--------------------------|---|
| <p><b>COLOR TEMP</b></p> | <p>Using the ▲/▼ buttons switches the color temperature mode.<br/>                     #1 HIGH DEFAULT ⇔ #1 HIGH CUSTOM ⇔ #2 MID DEFAULT<br/>                     ⇕<br/>                     #6 HI-BRIGHT-3 CUSTOM #2 MID CUSTOM<br/>                     ⇕<br/>                     #6 HI-BRIGHT-3 DEFAULT #3 LOW DEFAULT<br/>                     ⇕<br/>                     #5 HI-BRIGHT-2 CUSTOM #3 LOW CUSTOM<br/>                     ⇕<br/>                     #5 HI-BRIGHT-2 DEFAULT ⇔ #4 HI-BRIGHT-1 CUSTOM ⇔ #4 HI-BRIGHT-1 DEFAULT</p> <p><b>To adjust CUSTOM</b></p> <p>Selecting a mode whose name includes CUSTOM and then pressing the ► button or the ENTER button displays a dialog to aid you in adjusting the OFFSET and GAIN of the selected mode.</p>  <p>OFFSET adjustments change the color intensity on the whole tones of the test pattern.<br/>                     GAIN adjustments mainly affect color intensity on the brighter tones of the test pattern.</p> <p>Choose an item using the ◀/▶ buttons, and adjust the level using the ▲/▼ buttons.</p> <p>You can display a test pattern for checking the effect of your adjustment by pressing the ENTER button. Each time you press the ENTER button, the pattern changes as below.</p> <p>No pattern ⇔ Gray scale of 9 steps ⇐↵<br/>                     ↵⇐ Ramp ⇔ Gray scale of 15 steps</p> <ul style="list-style-type: none"> <li>• When this function is performed, lines or other distortion may appear.</li> </ul> |
| <p><b>COLOR</b></p>      | <p>Using the ▲/▼ buttons adjusts the strength of whole color.<br/>                     Strong ⇔ Weak</p> <ul style="list-style-type: none"> <li>• This item can be selected only for a video signal, s-video, or component video signal.</li> </ul>   |
| <p><b>TINT</b></p>       | <p>Using the ▲/▼ buttons adjusts the tint.<br/>                     Greenish ⇔ Reddish</p> <ul style="list-style-type: none"> <li>• This item can be selected only for a video signal, s-video, or component video signal.</li> </ul>   |

(continued on next page)

PICTURE menu

PICTURE menu (continued)

| Item                    | Description  |
|-------------------------|--|
| <p><b>SHARPNESS</b></p> | <p>Using the ▲/▼ buttons adjusts the sharpness.<br/>                     Strong ⇔ Weak</p> <ul style="list-style-type: none"> <li>• There may be some noise and/or the screen may flicker for a moment when an adjustment is made. This is not a malfunction.</li> </ul>   |
| <p><b>MY MEMORY</b></p> | <p>This projector has 4 memories for adjustment data (for all the items of PICTURE menu).<br/>                     Selecting a function using the ▲/▼ buttons and pressing the ► or <b>ENTER</b> button performs each function.</p> <div style="text-align: center;"> <p>LOAD-1 ⇔ LOAD-2 ⇔ LOAD-3 ⇔ LOAD-4</p> <p>SAVE-4 ⇔ SAVE-3 ⇔ SAVE-2 ⇔ SAVE-1</p> </div> <p><b><u>LOAD-1, LOAD-2, LOAD-3, LOAD-4</u></b></p> <p>Performing a LOAD function loads the data from the memory linked in the number included in the function's name, and adjusts the picture automatically depending on the data.</p> <ul style="list-style-type: none"> <li>• The LOAD functions whose linked memory has no data are skipped.</li> <li>• Remember that the current adjusted condition will be lost by loading data. If you want to keep the current adjustment, please save it before performing a LOAD function.</li> <li>• There may be some noise and the screen may flicker for a moment when loading data. This is not malfunction.</li> <li>• You can perform the LOAD function using MY BUTTONS. Please see MY BUTTON item in OPTION menu (44).</li> </ul> <p><b><u>SAVE-1, SAVE-2, SAVE-3, SAVE-4</u></b></p> <p>Performing a SAVE function saves the current adjustment data into the memory linked in the number included in the function's name.</p> <ul style="list-style-type: none"> <li>• Remember that the current data being stored of a memory will be lost by saving a new data into the memory.</li> </ul> |

IMAGE menu

IMAGE menu

From the IMAGE menu, items shown in the table below can be performed.

Select an item using the ▲/▼ cursor buttons, and press the ► cursor button or **ENTER** button to execute the item. Then perform it according to the following table.

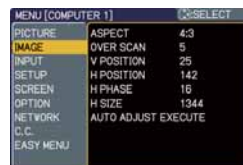

| Item              | Description   |
|-------------------|---|
| <b>ASPECT</b>     | <p>Using the ▲/▼ buttons switches the mode for aspect ratio.</p> <p><b>For a computer signal</b><br/>           NORMAL ⇔ 4:3 ⇔ 16:9<br/>           ↑—————↑</p> <p><b>For a Video signal, S-video signal or Component video signal</b><br/>           4:3 ⇔ 16:9 ⇔ 14:9<br/>           ↑—————↑</p> <p><b>For no signal</b><br/>           4:3 (fixed)</p> <ul style="list-style-type: none"> <li>• The NORMAL mode keeps the original aspect ratio of the signal.</li> </ul>   |
| <b>OVER SCAN</b>  | <p>Using the ▲/▼ buttons adjusts the over-scan ratio.</p> <p>Large (It reduces picture) ⇔ Small (It magnifies picture)</p> <ul style="list-style-type: none"> <li>• This item can be selected only for a video, s-video and component video signal.</li> <li>• When this adjustment is too large, certain degradation may appear at the frame area of the picture. In such a case, please adjust small.</li> </ul>  |
| <b>V POSITION</b> | <p>Using the ▲/▼ buttons adjusts the vertical position.</p> <p>Up ⇔ Down</p> <ul style="list-style-type: none"> <li>• Over-adjusting the vertical position may cause noise to appear on the screen. If this occurs please reset the vertical position to the default setting.</li> </ul> <p>Pressing <b>RESET</b> button when V POSITION is selected will reset V POSITION to the default setting.</p> <ul style="list-style-type: none"> <li>• When this function is performed on a video signal, s-video signal, or component video signal, the range of this adjustment depends on OVER SCAN (<a href="#">above</a>) setting. It is not possible to adjust when OVER SCAN is set to 10.</li> </ul> |

(continued on next page)

**IMAGE menu**

**IMAGE menu (continued)**

| Item                              | Description   |
|-----------------------------------|---|
| <p><b>H POSITION</b></p>          | <p>Using the ▲/▼ buttons adjusts the horizontal position.<br/>Left ⇔ Right</p> <ul style="list-style-type: none"> <li>• Over-adjusting the horizontal position may cause noise to appear on the screen. If this occurs please reset the horizontal position to the default setting. Pressing <b>RESET</b> button when H POSITION is selected will reset H POSITION to the default setting.</li> <li>• When this function is performed on a video signal, s-video signal, or component video signal, the range of this adjustment depends on OVER SCAN (🔗31) setting. It is not possible to adjust when OVER SCAN is set to 10.</li> </ul>   |
| <p><b>H PHASE</b></p>             | <p>Using the ▲/▼ buttons adjusts the horizontal phase to eliminate flicker.<br/>Right ⇔ Left</p> <ul style="list-style-type: none"> <li>• This item can be selected only for a computer signal or component video signal.</li> </ul>  |
| <p><b>H SIZE</b></p>              | <p>Using the ▲/▼ buttons adjusts the horizontal size.<br/>Large ⇔ Small</p> <ul style="list-style-type: none"> <li>• This item can be selected only for a computer signal.</li> <li>• When this adjustment is excessive, the picture may not be displayed correctly. In such a case, please reset the adjustment by pressing the <b>RESET</b> button during this operation.</li> </ul>  |
| <p><b>AUTO ADJUST EXECUTE</b></p> | <p>Executing this item performs the automatic adjustment feature.</p> <p><b>For a computer signal</b><br/>The vertical position, the horizontal position and the horizontal phase (🔗31, 32) will be automatically adjusted. Make sure that the application window is set to its maximum size prior to attempting to use this feature. A dark picture may still be incorrectly adjusted. Use a bright picture when adjusting.</p> <p><b>For a video signal and s-video signal</b><br/>The video format best suited for the respective input signal will be selected automatically. This function is available only when the AUTO is selected for the VIDEO FORMAT item in the INPUT menu (🔗34). The vertical position and horizontal position will be automatically set to the default.</p> <p><b>For a component video signal</b><br/>The vertical position, horizontal position and horizontal phase will be automatically set to the default.</p> <ul style="list-style-type: none"> <li>• The automatic adjustment operation requires approx. 10 seconds. Also please note that it may not function correctly with some input. When this function is performed for a video signal, a certain extra such as a line may appear outside a picture.</li> <li>• The items adjusted by this function may vary when the FINE or DISABLE is selected for the AUTO ADJUST item of the SERVICE item in the OPTION menu (🔗45).</li> </ul> |



INPUT menu

INPUT menu

From the INPUT menu, items shown in the table below can be performed.

Select an item using the ▲/▼ cursor buttons, and press the ► cursor button or **ENTER** button to execute the item. Then perform it according to the following table.



| Item               | Description   |
|--------------------|---|
| <b>PROGRESSIVE</b> | <p>Using the ▲/▼ buttons switches the progress mode.<br/>           TV ⇔ FILM ⇔ TURN OFF<br/>           ↑</p> <ul style="list-style-type: none"> <li>• This function is performed only for an interlaced signal at the VIDEO or S-VIDEO input, and for 525i (480i) or 625i(576i) signal at the COMPONENT VIDEO input.</li> <li>• When TV or FILM is selected, the screen image will be sharp. FILM adapts to the 2-3 Pull-Down conversion system. But these may cause a certain defect (for example, jagged line) of the picture for a quick moving object. In such a case, please select TURN OFF, even though the screen image may lose the sharpness.</li> </ul> |
| <b>VIDEO NR</b>    | <p>Using the ▲/▼ buttons switches the noise reduction mode.<br/>           HIGH ⇔ MID ⇔ LOW<br/>           ↑</p> <ul style="list-style-type: none"> <li>• This function is performed only for the VIDEO or S-VIDEO input, and for 525i (480i) or 625i(576i) signal at the COMPONENT VIDEO input.</li> <li>• When this function is excessive, it may cause a certain degradation of the picture.</li> </ul>  |
| <b>COLOR SPACE</b> | <p>Using the ▲/▼ buttons switches the mode for color space.<br/>           AUTO ⇔ RGB ⇔ SMPTE240 ⇔ REC709 ⇔ REC601<br/>           ↑</p> <ul style="list-style-type: none"> <li>• This item can be selected only for a computer signal or component video signal except SCART RGB signal.</li> <li>• The AUTO mode automatically selects the optimum mode.</li> <li>• The AUTO operation may not work well at some signals. In such a case, it might be good to select a suitable mode except AUTO.</li> </ul>   |
| <b>COMPONENT</b>   | <p>Using the ▲/▼ buttons switches the function of the COMPONENT (Y, C<sub>B</sub>/P<sub>B</sub>, C<sub>R</sub>/P<sub>R</sub>) port.<br/>           COMPONENT ⇔ SCART RGB</p> <p>When the SCART RGB is selected, COMPONENT (Y, C<sub>B</sub>/P<sub>B</sub>, C<sub>R</sub>/P<sub>R</sub>) and VIDEO ports will function as a SCART RGB port. A SCART cable is required for a SCART RGB input to the projector. For your reference, see the TECHNICAL part.</p>  |

(continued on next page)



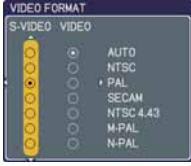
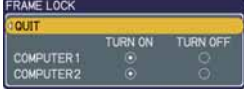
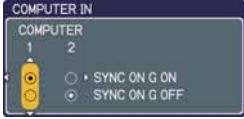

INPUT menu

INPUT menu (continued)

| Item                       | Description   |
|----------------------------|---|
| <p><b>VIDEO FORMAT</b></p> | <p>The video format for S-VIDEO port and VIDEO port can be set.<br/>                     (1) Use the ◀/▶ buttons to select the input port.<br/>                     (2) Using the ▲/▼ buttons switches the mode for video format.<br/>                     AUTO ⇔ NTSC ⇔ PAL ⇔ SECAM<br/>                     ⇕ N-PAL ⇔ M-PAL ⇔ NTSC4.43 ⇕</p> <ul style="list-style-type: none"> <li>• This item is performed only for a video signal from VIDEO port or S-VIDEO port.</li> <li>• The AUTO mode automatically selects the optimum mode.</li> <li>• The AUTO operation may not work well for some signals. If the picture becomes unstable (e.g. an irregular picture, lack of color), please select the mode according to the input signal.</li> </ul>  |
| <p><b>FRAME LOCK</b></p>   | <p>Set the frame lock function on/off for each port.<br/>                     (1) Using the ▲/▼ buttons to select one of following ports.<br/>                     COMPUTER (IN)1 ⇔ COMPUTER (IN)2<br/>                     (2) Using the ◀/▶ buttons to turns the frame lock function on/off.<br/>                     TURN ON ⇔ TURN OFF</p> <ul style="list-style-type: none"> <li>• This item can be performed only on a signal with a vertical frequency of 50 to 60 Hz.</li> <li>• When the TURN ON is selected, a moving pictures are displayed more smoothly.</li> <li>• This function may cause a certain degradation of the picture. In such a case, please select TURN OFF.</li> </ul>   |
| <p><b>COMPUTER IN</b></p>  | <p>The computer input signal type for COMPUTER IN1 and IN2 ports can be set.<br/>                     (1) Use the ◀/▶ buttons to select the input port to be set.<br/>                     COMPUTER (IN)1 ⇔ COMPUTER (IN)2<br/>                     (2) Use the ▲/▼ buttons to select the computer input signal type.<br/>                     SYNC ON G ON ⇔ SYNC ON G OFF</p> <p>Selecting SYNC ON G ON allows reception of sync on G signal.</p> <ul style="list-style-type: none"> <li>• When SYNC ON G ON is selected, the picture may be distorted with certain input signals. In such a case, remove the signal connector first and select SYNC ON G OFF on the menu, and then reconnect the signal.</li> </ul>                                 |

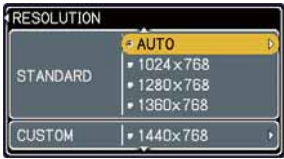
(continued on next page)

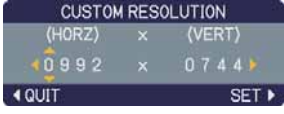
INPUT menu (continued)

| Item                     | Description   |
|--------------------------|---|
| <p><b>RESOLUTION</b></p> | <p>The resolution for the COMPUTER IN1 and IN2 input signals can be set on this projector.</p> <p>(1) In the INPUT menu select the RESOLUTION using the ▲/▼ buttons and press the ► button. The RESOLUTION menu will be displayed.</p> <p>(2) In the RESOLUTION menu, select the resolution you wish to display using the ▲/▼ buttons. Selecting AUTO will set a resolution appropriate to the input signal.</p>  <p>(3) STANDARD<br/>Pressing the ► or ENTER button when selecting a STANDARD resolution will automatically adjust the horizontal and vertical positions, clock phase and horizontal size and automatically select an aspect ratio.</p>  <p>(3) CUSTOM<br/>(3)-1 To set a custom resolution use the ▲/▼ buttons to select the CUSTOM and the CUSTOM RESOLUTION box will be displayed. Set the horizontal (HORZ) and vertical (VERT) resolutions using the ▲/▼ /◀/► buttons. It is not guaranteed to work this function properly on any resolutions.</p>  <p>(3)-2 To save the setting place the cursor on the right-most digit and press the ► button. The horizontal and vertical positions, clock phase and horizontal size will be automatically adjusted.</p>  <p>(3)-3 To revert back to the previous resolution without saving changes place the cursor on the left-most digit and press the ◀ button. The screen will then return to the RESOLUTION menu displaying the previous resolution.</p>  <p>• For some pictures, this function may not work well.</p> |

SETUP menu

SETUP menu

From the SETUP menu, items shown in the table below can be performed.

Select an item using the ▲/▼ cursor buttons, and press the ► cursor button or the **ENTER** button to execute the item. Then perform it according to the following table.

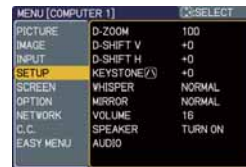

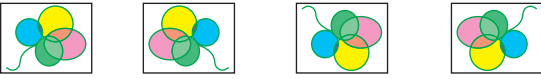
| Item  | Description  |
|---|--|
| <b>D-ZOOM</b>   | Using the ▲/▼ buttons adjusts the zoom.<br>Large ⇔ Small   |
| <b>D-SHIFT V</b>  | Using the ▲/▼ buttons adjusts the vertical picture position.<br>Up ⇔ Down<br>• The function is not available, if the D-ZOOM is adjusted to 100 (full screen) on its dialog.  |
| <b>D-SHIFT H</b>  | Using the ▲/▼ buttons adjusts the horizontal picture position.<br>Right ⇔ Left<br>• The function is not available, if the D-ZOOM is adjusted to 100 (full screen) on its dialog.   |
| <b>KEYSTONE</b>  | Using the ▲/▼ buttons corrects the vertical keystone distortion.<br>Shrink the top of the image ⇔ Shrink the bottom of the image<br>• The adjustable range of this function will vary with the type of input signal. For some input, this function may not work well.<br>• This function will be unavailable when the Transition Detector is on ( <a href="#">51</a> ).  |
| <b>WHISPER</b>  | Using the ▲/▼ buttons turns off/on the whisper mode.<br>NORMAL ⇔ WHISPER<br>• When WHISPER is selected, acoustic noise and screen brightness are reduced.  |
| <b>MIRROR</b>   | Using the ▲/▼ buttons switches the mode for mirror status.<br><br>NORMAL ⇔ H:INVERT ⇔ V:INVERT ⇔ H&V:INVERT<br>↑<br>If the Transition Detector is TURN ON and MIRROR status is changed, Transition Detector Alarm ( <a href="#">51</a> ) will be displayed when projector is restarted after the power switch is turned off. |
| <b>VOLUME</b>   | Using the ▲/▼ buttons adjusts the volume.<br>High ⇔ Low  |

(continued on next page)

SETUP menu (continued)

| Item           | Description   |
|----------------|---|
| <b>SPEAKER</b> | Using the ▲/▼ buttons turns on/off the built-in speaker.<br>TURN ON ⇄ TURN OFF<br>When TURN OFF is selected, the built-in speaker does not work.  |
| <b>AUDIO</b>   | Allocates the audio ports.<br>(1) Choose a picture input port using the ▲/▼ buttons.<br>QUIT ⇄ COMPUTER (IN)1 ⇄ COMPUTER (IN)2<br>↵ VIDEO ⇄ S-VIDEO ⇄ COMPONENT ⇄ ↵<br>(2) Select the audio port to be interlocked with the input port using the ◀/▶ buttons.<br>1 ⇄ 2 ⇄ 3 ⇄ ✕<br>↵—————↵<br>• When ✕ is selected for an input, the audio will not be output if the input is chosen as a display source.<br>• When ✕ is selected to VIDEO, S-VIDEO or COMPONENT port, the C.C.(Closed Caption) is automatically activated, if the C.C. is set to AUTO in the DISPLAY menu of the C.C. menu and the signal from the input port supports the C.C. feature (60). |



**SCREEN menu**

**SCREEN menu**

From the SCREEN menu, items shown in the table below can be performed.

Select an item using the ▲/▼ cursor buttons, and press the ► cursor button or **ENTER** button to execute the item. Then perform it according to the following table.



| Item                 | Description  |  |         |          |   |          |                                       |                    |                              |
|----------------------|--|--|---------|----------|---|----------|---------------------------------------|--------------------|------------------------------|
| <b>LANGUAGE</b>      | <p>Using the ▲/▼ buttons switches the OSD (On Screen Display) language.</p> <p>ENGLISH ⇄ FRANÇAIS ⇄ DEUTSCH ⇄ ESPAÑOL ⇄ ITALIANO</p> <p>⇕</p> <p>TÜRKÇE NORSK</p> <p>⇕</p> <p>POLSKI NEDERLANDS</p> <p>⇕</p> <p>SUOMI PORTUGUÊS</p> <p>⇕</p> <p>РУССКИЙ ⇄ SVENSKA ⇄ 한글 ⇄ 繁體中文 ⇄ 简体中文 ⇄ 日本語</p>   |  |         |          |   |          |                                       |                    |                              |
| <b>MENU POSITION</b> | <p>Using the ▲/▼/◀/▶ buttons adjusts the menu position.</p> <p>To quit the operation, press <b>MENU</b> button on the remote control or keep no operation for about 10 seconds.</p>  |  |         |          |   |          |                                       |                    |                              |
| <b>BLANK</b>         | <p>Using the ▲/▼ buttons switches the mode for the BLANK screen. The BLANK screen is a screen for the temporarily blanking feature (43). It is displayed by pressing <b>BLANK</b> button.</p> <p>MyScreen ⇄ ORIGINAL ⇄ BLUE ⇄ WHITE ⇄ BLACK</p> <p>↑</p> <table border="1"> <thead> <tr> <th></th> <th>Feature</th> </tr> </thead> <tbody> <tr> <td>MyScreen</td> <td>Screen can be registered by the MyScreen item (40).</td> </tr> <tr> <td>ORIGINAL</td> <td>Screen preset as the standard screen.</td> </tr> <tr> <td>BLUE, WHITE, BLACK</td> <td>Plain screens in each color.</td> </tr> </tbody> </table> <p>• To avoid remaining as an afterimage, the MyScreen or ORIGINAL screen will change to the plain black screen after several minutes.</p> |  | Feature | MyScreen | Screen can be registered by the MyScreen item (40). | ORIGINAL | Screen preset as the standard screen. | BLUE, WHITE, BLACK | Plain screens in each color. |
|                      | Feature  |  |         |          |   |          |                                       |                    |                              |
| MyScreen             | Screen can be registered by the MyScreen item (40).  |  |         |          |   |          |                                       |                    |                              |
| ORIGINAL             | Screen preset as the standard screen.  |  |         |          |   |          |                                       |                    |                              |
| BLUE, WHITE, BLACK   | Plain screens in each color.   |  |         |          |   |          |                                       |                    |                              |

(continued on next page)

**SCREEN menu (continued)**

| Item            | Description  |  |         |          |   |          |                                       |          |                     |
|-----------------|--|--|---------|----------|---|----------|---------------------------------------|----------|---------------------|
| <b>START UP</b> | <p>Using the ▲/▼ buttons switches the mode for the start-up screen. The start-up screen is a screen displayed when no signal or an unsuitable signal is detected.</p> <p style="text-align: center;">MyScreen ⇄ ORIGINAL ⇄ TURN OFF</p> <div style="text-align: center;"> </div> <table border="1" data-bbox="555 712 1254 855" style="width: 100%; border-collapse: collapse;"> <thead> <tr> <th style="width: 50%;"></th> <th style="width: 50%;">Feature</th> </tr> </thead> <tbody> <tr> <td>MyScreen</td> <td>Screen can be registered by the MyScreen item (40).</td> </tr> <tr> <td>ORIGINAL</td> <td>Screen preset as the standard screen.</td> </tr> <tr> <td>TURN OFF</td> <td>Plain black screen.</td> </tr> </tbody> </table> <ul style="list-style-type: none"> <li>• To avoid remaining as an afterimage, the MyScreen or ORIGINAL screen will change to the BLANK screen (38) after several minutes. If also the BLANK screen is the MyScreen or ORIGINAL, the plain black screen is instead used.</li> <li>• When the TURN ON is selected to the MyScreen PASSWORD of SECURITY item in OPTION menu (48), the START UP is fixed to MyScreen.</li> </ul> |  | Feature | MyScreen | Screen can be registered by the MyScreen item (40). | ORIGINAL | Screen preset as the standard screen. | TURN OFF | Plain black screen. |
|                 | Feature  |  |         |          |   |          |                                       |          |                     |
| MyScreen        | Screen can be registered by the MyScreen item (40).  |  |         |          |   |          |                                       |          |                     |
| ORIGINAL        | Screen preset as the standard screen.  |  |         |          |   |          |                                       |          |                     |
| TURN OFF        | Plain black screen.  |  |         |          |   |          |                                       |          |                     |

(continued on next page)

SCREEN menu

SCREEN menu (continued)

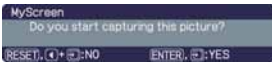
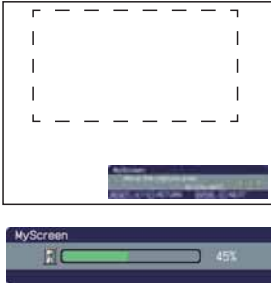
| Item                        | Description   |
|-----------------------------|---|
| <p><b>MyScreen</b></p>      | <p>This item allows you to capture an image for use as a MyScreen image which can be used as the BLANK screen and START UP screen. Display the image you want to capture before executing the following procedure.</p> <ol style="list-style-type: none"> <li>1. Selecting this item displays a dialog titled "MyScreen". It will ask you if you start capturing an image from the current screen.            <p>Please wait for the target image to be displayed, and press the <b>ENTER</b> button when the image is displayed. The image will freeze and the frame for capturing will appear. To stop performing, press the <b>RESET</b> or <b>ESC</b> button.</p> </li> <li>2. Using the <b>▲/▼/◀/▶</b> buttons adjusts the frame position.            <p>Please move the frame to the position of the image which you want to use. The frame may not be able to be moved for some input signals. To start registration, press the <b>ENTER</b> button. To restore the screen and return to the previous dialog, press the <b>RESET</b> or <b>ESC</b> button. Registration takes several minutes. When the registration is completed, the registered screen and the following message are displayed for several seconds: <b>"MyScreen registration is finished."</b> If the registration failed, the following message is displayed: <b>"A capturing error has occurred. Please try again."</b></p> <ul style="list-style-type: none"> <li>• This function cannot be selected when the TURN ON is selected to the MyScreen Lock item (<a href="#">below</a>).</li> <li>• This function cannot be selected when TURN ON is selected to the MyScreen PASSWORD of SECURITY item in OPTION menu (<a href="#">48</a>).</li> </ul> </li> </ol> |
| <p><b>MyScreen Lock</b></p> | <p>Using the <b>▲/▼</b> buttons turns on/off the MyScreen lock function.<br/>TURN ON ⇔ TURN OFF</p> <p>When the TURN ON is selected, the MyScreen item is locked. Use this function for protecting the current MyScreen.</p> <ul style="list-style-type: none"> <li>• This function cannot be selected when TURN ON is selected to the MyScreen PASSWORD of SECURITY item in OPTION menu (<a href="#">48</a>).</li> </ul>   |

(continued on next page)



SCREEN menu (continued)

| Item                      | Description  |
|---------------------------|--|
| <p><b>MESSAGE</b></p>     | <p>Using the ▲/▼ buttons turns on/off the message function.<br/>TURN ON ⇔ TURN OFF</p> <p>When the TURN ON is selected, the following message function works.<br/>“AUTO IN PROGRESS” while automatically adjusting<br/>“NO INPUT IS DETECTED”<br/>“SYNC IS OUT OF RANGE”<br/>“Searching...” while searching for the input<br/>“Detecting...” while an input signal is detected<br/>The indication of the input signal displayed by changing<br/>The indication of the aspect ratio displayed by changing<br/>The indication of the PICTURE MODE displayed by changing<br/>The indication of the MY MEMORY displayed by changing<br/>The indication of “FREEZE” and “II” while the projector is in the FREEZE mode.</p> <ul style="list-style-type: none"> <li>• If the projector goes into the FREEZE mode while the TURN OFF is selected, the picture on screen is frozen without any messages, which is not a malfunction (23).</li> </ul>   |
| <p><b>SOURCE NAME</b></p> | <p>Each input port for this projector can have a name applied to it.</p> <p>(1) Use the ▲/▼ buttons on the SCREEN menu to select SOURCE NAME and press the ► button. The SOURCE NAME menu will be displayed.</p> <p>(2) Use the ▲/▼ buttons on the SOURCE NAME menu to select the port to be named and press the ► button. Right side of the menu is blank until a name is specified. The SOURCE NAME dialog will be displayed.</p> <p>(3) The current name will be displayed on the first line. Use the ▲/▼/◀/▶ buttons and the <b>ENTER</b> or <b>INPUT</b> button to select and enter characters. The <b>RESET</b> button can be used to erase 1 character at a time. Also if you move the cursor to <b>DELETE</b> or <b>ALL CLEAR</b> on screen and push the <b>ENTER</b> or <b>INPUT</b> button, 1 character or all characters will be erased. The name can be a maximum of 16 characters.</p> <p>(4) To change an already inserted character, press the (▲) button to move the cursor to the first line, and use the ◀/▶ buttons to move the cursor on the character to be changed.</p> <p>After pressing the <b>ENTER</b> or <b>INPUT</b> button, the character is selected. Then, follow the same procedure as described at the item (3) above.</p> <p>(5) To finish entering text, move the cursor to the <b>SAVE</b> on screen and press the <b>ENTER</b> or <b>INPUT</b> button. To revert to the previous name without saving changes, move the cursor to the <b>CANCEL</b> on screen and press the <b>ENTER</b> or <b>INPUT</b> button.</p> <div data-bbox="1034 1061 1262 1173"> </div> <div data-bbox="1023 1205 1273 1339"> </div> <div data-bbox="1023 1352 1273 1487"> </div> <div data-bbox="1023 1500 1273 1635"> </div> |

**OPTION menu**

**OPTION menu**

From the OPTION menu, items shown in the table below can be performed.



Select an item using the ▲/▼ cursor buttons, and press the ► cursor button or **ENTER** button to execute the item, except for the items LAMP TIME and FILTER TIME. Then perform it according to the following table.



| Item               | Description   |
|--------------------|---|
| <b>AUTO SEARCH</b> | <p>Using the ▲/▼ buttons turns on/off the automatic signal search function.<br/>TURN ON ⇔ TURN OFF</p> <p>When the TURN ON is selected, detecting no signal automatically cycles through input ports in the following order. The search is started from the current port. Then when an input is found, the projector will stop searching and display the image.</p> <pre> ┌───┐ │   │ │   │ └───┘ ┌───┐ │   │ │   │ └───┘ COMPUTER IN1 ⇨ COMPUTER IN2 ┌───┐ │   │ │   │ └───┘ VIDEO ⇔ S-VIDEO ⇔ COMPONENT </pre>  |
| <b>AUTO ON</b>     | <p>Using the ▲/▼ buttons turns on/off the AUTO ON function.<br/>TURN ON ⇔ TURN OFF</p> <p>When set to the TURN ON, the lamp in projector will be automatically turned on without the usual procedure (P.16), only when the projector is supplied with the power after the power was cut while the lamp was on.</p> <ul style="list-style-type: none"> <li>• This function does not work as long as the power has been supplied to the projector while the lamp is off.</li> <li>• After turning the lamp on by the AUTO ON function, if neither input nor operation is detected for about 30 minutes, the projector is turned off, even though the AUTO OFF function (P.43) is disabled.</li> </ul> |

(continued on next page)

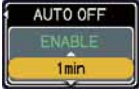



OPTION menu (continued)

| Item                      | Description   |
|---------------------------|---|
| <p><b>AUTO OFF</b></p>    | <p>Using the ▲/▼ buttons adjusts the time to count down to automatically turn the projector off.<br/>                     Long (max. 99 minutes) ⇔ Short (min. 0 minute = DISABLE)</p> <div style="display: flex; justify-content: space-around; align-items: center;">   </div> <p>When the time is set to 0, the projector is not turned off automatically. When the time is set to 1 to 99, and when the passed time with no-signal or an unsuitable signal reaches at the set time, the projector lamp will be turned off.<br/>                     If one of the projector's buttons or the remote control buttons is pressed or one of the commands (except get commands) is transmitted to the CONTROL port during the corresponding time, projector will not be turned off.<br/>                     Please refer to the section "Turning off the power" (17).</p> |
| <p><b>LAMP TIME</b></p>   | <p>The lamp time is the usage time of the lamp, counted after the last resetting. It is shown in the OPTION menu.<br/>                     Pressing <b>RESET</b> button or the ► button displays a dialog.<br/>                     To reset the lamp time, select RESET using the ▲ button.<br/>                     RESET ⇔ CANCEL</p> <ul style="list-style-type: none"> <li>• Please reset the lamp time only when you have replaced the lamp, for a suitable indication about the lamp.</li> <li>• For the lamp replacement, see the section "Replacing the lamp" (61).</li> </ul>   |
| <p><b>FILTER TIME</b></p> | <p>The filter time is the usage time of the air-filter, counted after the last resetting. It is shown in the OPTION menu.<br/>                     Pressing the <b>RESET</b> button or the ► button displays a dialog.<br/>                     To reset the filter time, select the RESET using the ▲ button.<br/>                     RESET ⇔ CANCEL</p> <ul style="list-style-type: none"> <li>• Please reset the filter time only when you have cleaned or replaced the air-filter, for a suitable indication about the air-filter.</li> <li>• For the air-filter cleaning, see the section "Maintaining the air-filter" (63).</li> </ul>   |

(continued on next page)



**OPTION menu**

**OPTION menu (continued)**

| Item                    | Description  |
|-------------------------|--|
| <p><b>MY BUTTON</b></p> | <p>This item is to assign one of the following functions to MY BUTTON 1 and 2 on the remote control (116). Choose 1 or 2 on the MY BUTTON menu using the ◀/▶ button first. Then using the ▲/▼ buttons sets one of the following functions to the chosen button.</p> <ul style="list-style-type: none"> <li>• COMPUTER1: Sets port to COMPUTER IN1.</li> <li>• COMPUTER2: Sets port to COMPUTER IN2.</li> <li>• COMPONENT: Sets port to COMPONENT (Y, Cb/Pb, Cr/Pr)</li> <li>• S-VIDEO: Sets port to S-VIDEO.</li> <li>• VIDEO: Sets port to VIDEO.</li> <li>• INFORMATION: Displays the INPUT -INFORMATION- (1146) or NETWORK -INFORMATION- (1159) or nothing.</li> </ul> <p>The displayed dialog is switched as below every time the MY BUTTON is pushed.</p> <p>When an input signal is found:<br/>         INPUT -INFORMATION- ⇄ NETWORK -INFORMATION- ⇄ OFF</p>  <p>When an input signal is not found:<br/>         NETWORK -INFORMATION- ⇄ OFF</p> <ul style="list-style-type: none"> <li>• MY MEMORY: Loads one of adjustment data stored (1130). When more than one data are saved, the adjustment changes every time the MY BUTTON is pushed. When no data is saved in memory, the dialog "No saved data" appears.</li> </ul>  <p>When the current adjustment is not saved to memory, the dialog as shown in the right appears.</p>  <p>If you want to keep the current adjustment, please press the ◀ button to quit. Otherwise loading a data will lose the current adjusted condition.</p> <ul style="list-style-type: none"> <li>• PICTURE MODE: Changes the PICTURE MODE (1126).</li> <li>• FILTER RESET: Displays the filter time reset confirmation dialogue (1143).</li> <li>• VOLUME+: Set the volume up.</li> <li>• VOLUME-: Set the volume down.</li> <li>• AV MUTE: Turns the picture and audio on/off.</li> <li>• e-SHOT: Displays the e-SHOT menu (1158).</li> </ul> |
| <p><b>SERVICE</b></p>   | <p>Selecting this item displays the SERVICE menu. Select an item using the ▲/▼ buttons, and press the ▶ button or the ENTER button to execute the item.</p> <p>FAN SPEED ⇄ AUTO ADJUST ⇄ GHOST ⇄ FILTER MESSAGE ⇄ KEY LOCK ⇄ FOCUS LOCK</p>  <p>↑ ↘ FACTORY RESET ⇄ I NFORMATION ⇄ REMOTE FREQ. ⇄ REMOTE RECEIV. ↙ ↓</p>   |

(continued on next page)

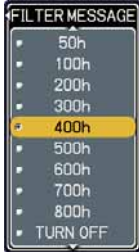

OPTION menu (continued)

| Item                           | Description   |
|--------------------------------|---|
| <p>SERVICE<br/>(continued)</p> | <p><b>FAN SPEED</b><br/>Using the ▲/▼ buttons the rotation speed of the cooling fans. The HIGH is the mode for use at highlands etc. Note that the projector is noisier when the HIGH is selected.<br/>HIGH ⇔ NORMAL</p>   |
|                                | <p><b>AUTO ADJUST</b><br/>Using the ▲/▼ buttons to select one of the mode. When the DISABLE is selected, the H/V.POSITION, H.SIZE and H.PHASE will be set to the default value if the automatic adjustment function is executed.<br/>FINE ⇔ FAST ⇔ DISABLE<br/>↑—————↓<br/>FINE: Finer tuning including H.SIZE adjustment.<br/>FAST: Faster tuning, setting H.SIZE to prearranged data for the input signal.</p> <ul style="list-style-type: none"> <li>• Depending on conditions, such as input image, signal cable to the projector, environment around the projector, etc., the automatic adjustment may not work correctly. In such a case, please choose DISABLE to disable the automatic adjustment, and make adjustment manually.</li> </ul>   |
|                                | <p><b>GHOST</b><br/>1. Select a color element of ghost using the ◀/▶ buttons.<br/>2. Adjust the selected element using the ▲/▼ buttons to disappear ghost.</p>   |
|                                | <p><b>FILTER MESSAGE</b><br/>Use the ▲/▼ button to set the timer for the interval to show the message for cleaning up the air-filter.<br/>50h ⇔ 100h ⇔ 200h ⇔ 300h ⇔ 400h ⇔ 500h<br/>↑ TURN OFF ⇔ 800h ⇔ 700h ⇔ 600h ↓</p> <p>After choosing an item except TURN OFF, the message "REMINDER *** HRS PASSED AFTER THE LAST FILTER CHECK" will appear after the timer reaches the interval time set by this feature (68). When the TURN OFF is chosen, the message will not appear. Utilize this feature to keep the air-filter clean, setting the suitable time according to your environment of this projector.</p> <ul style="list-style-type: none"> <li>• Please check and clean the air-filter periodically, even if there is no message. If the air-filter becomes to be blocked by dust or others, the internal temperature will rise, which could cause malfunction, or reduce the lifetime of the projector.</li> <li>• Please be careful with the operating environment of the projector and the condition of the air-filter.</li> </ul>  |

(continued on next page)



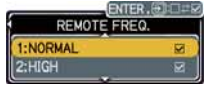

OPTION menu

OPTION menu (continued)

| Item                           | Description  |
|--------------------------------|--|
| <p>SERVICE<br/>(continued)</p> | <p><b>KEY LOCK</b><br/>Using the ▲/▼ buttons turns on/off the key lock feature. When TURN ON is selected, the buttons on the projector except the <b>STANDBY/ON</b> button are locked.<br/>TURN ON ⇔ TURN OFF</p> <ul style="list-style-type: none"> <li>• Please use to avoid a mischief and touching accidentally. This function does not have any effect on the remote control.</li> </ul>  |
|                                | <p><b>FOCUS LOCK</b><br/>Use the ▲/▼ buttons turns on/off the focus lock feature. When TURN ON is selected, the <b>FOCUS +/-</b> buttons on the remote and projector are disabled.<br/>TURN ON ⇔ TURN OFF</p> <ul style="list-style-type: none"> <li>• Please use the function to avoid a mischief and touching accidentally.</li> </ul>   |
|                                | <p><b>REMOTE RECEIV.</b><br/>(1) Select a remote sensor using ▲/▼ buttons.<br/>1:FRONT ⇔ 2:TOP<br/>(2) Switch it using the <b>ENTER</b> or <b>INPUT</b> button.<br/><input type="checkbox"/> (off) ⇔ <input checked="" type="checkbox"/> (on)</p> <p>• A sensor cannot be turned off when the other one is off. Always at least one sensor is on.</p>                          |
|                                | <p><b>REMOTE FREQ.</b><br/>Use the ▲/▼ button to change the projector's remote sensor setting.<br/>1:NORMAL ⇔ 2:HIGH</p> <p>Items with a checkmark are on. The factory default setting is for both 1:NORMAL and 2:HIGH to be on. If the remote control does not function correctly set this to either only 1 or only 2 (15). Neither can be turned off at the same time.</p>  |
|                                | <p><b>INFORMATION</b><br/>Selecting this item displays a dialog titled "INPUT -INFORMATION-". It shows the information about the current input.</p>  <ul style="list-style-type: none"> <li>• The "FRAME LOCK" message on the dialog means the frame lock function is working (34).</li> <li>• This item can't be selected for no signal and sync out.</li> </ul>              |
|                                | <p><b>FACTORY RESET</b><br/>Selecting RESET using the button ▲ performs this function. By this function, all the items in all of menus will collectively return to the initial setting. Note that the items LAMP TIME, FILTER TIME, LANGUAGE, SECURITY and NETWORK settings are not reset.<br/>RESET ⇔ CANCEL</p>  |

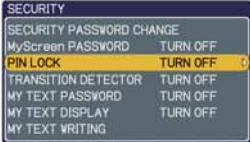
46 (continued on next page)

OPTION menu (continued)

| Item                   | Description   |
|------------------------|---|
| <p><b>SECURITY</b></p> | <p>This projector is equipped with security functions. User registration is required before using the security functions. Please contact your local dealer.</p>   |
|                        | <p><b>1. Using Security Features</b></p> <p><b>1.1 Inputting the PASSWORD</b></p> <p>1.1-1 Use the ▲/▼ buttons on the OPTION menu to select SECURITY and press the ► button. The ENTER PASSWORD box will be displayed.<br/>  The factory default PASSWORD is <b>4910</b>. This PASSWORD can be changed (1.2 Changing the PASSWORD (below)).</p> <ul style="list-style-type: none"> <li>It is strongly recommended the factory default PASSWORD to be changed as soon as possible.</li> </ul> <p>1.1-2 Use the ▲/▼/◀/▶ buttons to enter the registered PASSWORD. Move the cursor to the right side of the ENTER PASSWORD box and press the ► button to display the SECURITY menu.<br/>  If an incorrect PASSWORD is input the ENTER PASSWORD box will be displayed again. If incorrect PASSWORD is input 3 times the projector will turn off. Afterwards the projector will turn off every time an incorrect PASSWORD is input.</p> <p><b>1.2 Changing the PASSWORD</b></p> <p>1.2-1 Use the ▲/▼ buttons on the SECURITY menu to select SECURITY PASSWORD CHANGE and press the ► button to display the ENTER NEW PASSWORD box.<br/>  </p> <p>1.2-2 Use the ▲/▼/◀/▶ buttons to enter the new PASSWORD.</p> <p>1.2-3 Move the cursor to the right side of the ENTER NEW PASSWORD box and press the ► button to display the NEW PASSWORD AGAIN box, enter the same PASSWORD again.<br/>  </p> <p>1.2-4 Move the cursor to the right side of the NEW PASSWORD AGAIN box and press the ► button and the NOTE NEW PASSWORD box will be displayed for about 20 seconds, please make note of the PASSWORD during this time.<br/>  Pressing the <b>ENTER</b> button will close the NOTE NEW PASSWORD box.</p> <ul style="list-style-type: none"> <li>Please do not forget your PASSWORD.</li> </ul> |

(continued on next page)

OPTION menu

OPTION menu (continued)

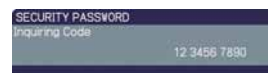

| Item                                   | Description  |
|--|--|
| <p><b>SECURITY</b><br/>(continued)</p> | <p><b>1.3 If you have forgotten your PASSWORD</b></p> <p>1.3-1 Follow the procedure in 1.1-1 to display the ENTER PASSWORD box.</p> <p>1.3-2 While the ENTER PASSWORD box is displayed, press and hold the <b>RESET</b> button for about 3 seconds or press and hold the INPUT and ► buttons on the projector for about 3 seconds. The 10-digit Inquiring Code will be displayed.</p> <ul style="list-style-type: none"> <li>• If there is no key input for about 55 seconds while the Inquiring Code is displayed the menu will close. If necessary repeat the process from 1.3-1.</li> </ul> <p>1.3-3 Contact your dealer with the 10-digit Inquiring Code. Your PASSWORD will be sent after your user registration information is confirmed.</p>  |
|  | <p><b>2. Using the MyScreen PASSWORD Function</b></p> <p>The MyScreen PASSWORD function can be used to prohibit access to the MyScreen function and prevent the currently registered MyScreen image from being overwritten.</p> <p><b>2.1 Turning on the MyScreen PASSWORD Function</b></p> <p>2.1-1 Use the ▲/▼ buttons on the SECURITY menu to select MyScreen PASSWORD and press the ► button to display the MyScreen PASSWORD on/off menu.</p> <p><b>2.2 Setting the PASSWORD</b></p> <p>2.2-1 Display the MyScreen PASSWORD on/off menu using the procedure in 2.1-1.</p> <p>2.2-2 Use the ▲/▼ buttons on the MyScreen PASSWORD on/off menu to select TURN ON. The ENTER PASSWORD box (small) will be displayed.</p> <p>2.2-3 Use the ▲/▼/◀/▶ buttons to enter the PASSWORD. Move the cursor to the right side of the ENTER PASSWORD box (small) and press the ► button to display the PASSWORD AGAIN box, enter the same PASSWORD again.</p> |



(continued on next page)





OPTION menu (continued)

| Item                                   | Description   |
|--|---|
| <p><b>SECURITY</b><br/>(continued)</p> | <p>2.2-4 Move the cursor to the right side of the PASSWORD AGAIN box and press the ► button to display the PASSWORD for about 20 seconds, please make note of the PASSWORD during this time.</p>  <p>Pressing the <b>ENTER</b> button will return to MyScreen PASSWORD on/off menu.<br/>When a PASSWORD is set for MyScreen:</p> <ul style="list-style-type: none"> <li>• The MyScreen registration function (and menu) will be unavailable.</li> <li>• The MyScreen Lock menu will be unavailable.</li> <li>• The START UP setting will be locked on MyScreen (and the menu will be unavailable).</li> </ul> <p>Turning the MyScreen PASSWORD off will allow normal operation of these functions.</p> <ul style="list-style-type: none"> <li>• Please do not forget your MyScreen PASSWORD.</li> </ul> <p><b>2.3 Turning the PASSWORD off</b></p> <p>2.3-1 Follow the procedure in 2.1-1 to display the MyScreen PASSWORD on/off menu.</p> <p>2.3-2 Select TURN OFF to display the ENTER PASSWORD box (large). Enter the registered PASSWORD and the screen will return to the MyScreen on/off menu.<br/>If an incorrect PASSWORD is input the menu will close. If necessary repeat the process from 2.3-1.</p> <p><b>2.4 If you have forgotten your PASSWORD</b></p> <p>2.4-1 Follow the procedure in 2.1-1 to display the MyScreen PASSWORD on/off menu.</p> <p>2.4-2 Select TURN OFF to display the ENTER PASSWORD box (large). The 10-digit Inquiring Code will be displayed inside the box.</p>  <p>2.4-3 Contact your dealer with the 10-digit Inquiring Code. Your PASSWORD will be sent after your user registration information is confirmed.</p> |
|  | <p><b>3. Using the PIN LOCK Function</b></p> <p>PIN LOCK is a function which prevents the projector from being used unless a registered Code is input.</p> <p><b>3.1 Registering the PIN Code</b></p> <p>3.1-1 Use the ▲/▼ buttons on the SECURITY menu to select PIN LOCK and press the ► button or the <b>ENTER</b> button to display the PIN LOCK on/off menu.</p>    |

(continued on next page)

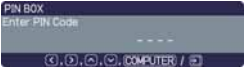

OPTION menu

OPTION menu (continued)

| Item                                   | Description  |
|--|--|
| <p><b>SECURITY</b><br/>(continued)</p> | <p>3.1-2 Use the ▲/▼ buttons on the PIN LOCK on/off menu to select TURN ON and the PIN BOX will be displayed.</p>  <p>3.1-3 Input a 4 part PIN Code using the ▲, ▼, ◀, ▶, <b>COMPUTER</b> and <b>INPUT</b> buttons. A PIN Code again box will appear. Reenter the same PIN Code. This will complete the PIN Code registration.</p> <ul style="list-style-type: none"> <li>• If there is no key input for about 55 seconds while the PIN BOX or the PIN Code again box are displayed the menu will close. If necessary repeat the process from 3.1-1.</li> </ul> <p>Afterwards, anytime the projector is restarted after AC power is turned off the PIN BOX will be displayed. Enter the registered PIN Code. The projector can be used after entering the registered PIN Code. If an incorrect PIN Code is input the PIN BOX will be displayed again. If an incorrect PIN Code is input 3 times the projector will turn off. Afterwards the projector will turn off every time an incorrect PIN Code is input. The projector will also turn off if there is no key input for about 5 minutes while the PIN BOX is displayed. This function will activate only when the projector is started after AC power is turned off.</p> <ul style="list-style-type: none"> <li>• Please do not forget your PIN Code.</li> </ul> |
|  | <p><b>3.2 Turning Off the PIN LOCK Function</b></p> <p>3.2-1 Follow the procedure in 3.1-1 to display the PIN LOCK on/off menu. Use the ▲/▼ buttons to select TURN OFF and the PIN BOX will be displayed. Enter the registered PIN Code to turn the PIN LOCK function off. If an incorrect PASSWORD is input 3 times, the projector will be shut down.</p>   |
|  | <p><b>3.3 If you have forgotten your PIN Code</b></p> <p>3.3-1 While the PIN BOX is displayed, press and hold the <b>RESET</b> button for 3 seconds or press and hold the <b>INPUT</b> and ▶ buttons for 3 seconds. The 10-digit Inquiring Code will be displayed.</p>  <ul style="list-style-type: none"> <li>• If it passes for about 5 minutes after the PIN BOX is displayed the projector will turn off.</li> </ul>  |
|  | <p>3.3-2 Contact your dealer with the 10-digit Inquiring Code. Your <b>PASSWORD</b> will be sent after your user registration information is confirmed.</p>  |

(continued on next page)

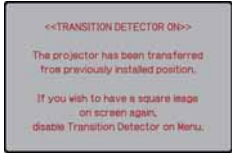
OPTION menu (continued)

| Item                                   | Description   |
|--|---|
| <p><b>SECURITY</b><br/>(continued)</p> | <p><b>4. Using the Transition Detector Function</b></p> <p>While the Transition Detector function is ON, when power switch is started to supply to the projector, it might react as below.</p> <ul style="list-style-type: none"> <li>• Transition Detector alarm shown below might appear on screen, if the projector has been moved or re-installed.</li> <li>• Transition Detector alarm might appear on screen, if the MIRROR setting has been changed.</li> <li>• Keystone adjustment feature has been prohibited as long as the Transition Detector function is ON.</li> </ul> <p><b>4.1 Turning On the Transition Detector Function</b></p> <p>4.1-1 Use the ▲/▼ buttons on the SECURITY menu to select TRANSITION DETECTOR and press the ► or the ENTER button to display the TRANSITION DETECTOR on/off menu. Select TURN ON and the current angle and mirror setting will be recorded.</p>  <ul style="list-style-type: none"> <li>• This feature may not function properly if the projector is not in a stable position when TURN ON is selected.</li> </ul> <p>4.1-2 When the projector is turned on, if this function is set to TURN ON and if the setting condition of the projector (normal use or ceiling mounted or tabletop use) or mirror setting is changed from previous record, the Transition Detector alarm will be displayed and the projector will not display the input image.</p>  <p>Set the Transition Detector off in the SECURITY menu to display the input signal.<br/>If the Transition Detector alarm is displayed for about 5 minutes the lamp will turn off. This function will activate only when the projector is started after turning off the AC power.</p> <p><b>4.2 Setting the Transition Detector PASSWORD</b></p> <p>4.2-1 Use the ▲/▼ buttons on the SECURITY menu to select TRANSITION DETECTOR and press the ► or the ENTER button to display the TRANSITION DETECTOR on/off menu.</p> <p>4.2-2 Use the ▲/▼ buttons on the TRANSITION DETECTOR on/off menu to select TURN ON. The ENTER PASSWORD box (small) will be displayed.</p>  <p>4.2-3 Use the ▲/▼/◀/▶ buttons to enter a PASSWORD. Move the cursor to the right side of the ENTER PASSWORD box (small) and press the ► button to display the PASSWORD AGAIN box, enter the same PASSWORD again.</p>  |

(continued on next page)

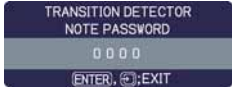
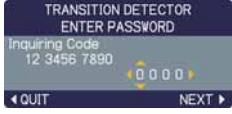

**OPTION menu**

**OPTION menu (continued)**

| Item                                   | Description   |
|--|---|
| <p><b>SECURITY</b><br/>(continued)</p> | <p>4.2-4 Move the cursor to the right side of the PASSWORD AGAIN box and press the ► button to display the PASSWORD for about 20 seconds, please make note of the PASSWORD during this time.</p>  <p>Pressing the <b>ENTER</b> button will return to the TRANSITION DETECTOR on/off menu.</p> <ul style="list-style-type: none"> <li>• Please do not forget your Transition Detector PASSWORD.</li> </ul> <p><b>4.3 Setting the Transition Detector off</b></p> <p>4.3-1 Follow the procedure in 4.1-1 to display the TRANSITION DETECTOR on/off menu.</p> <p>4.3-2 Select TURN OFF to display the ENTER PASSWORD box (large). Enter the registered PASSWORD and the screen will return to the TRANSITION DETECTOR on/off menu. If an incorrect PASSWORD is input the menu will close. If necessary repeat the process from 4.3-1.</p> <p><b>4.4 If you have forgotten your PASSWORD</b></p> <p>4.4-1 Follow the procedure in 4.1-1 to display the TRANSITION DETECTOR on/off menu.</p> <p>4.4-2 Select TURN OFF to display the ENTER PASSWORD box (large). The 10-digit Inquiring Code will be displayed inside the box.</p>  <p>4.4-3 Contact your dealer with the 10-digit Inquiring Code. Your PASSWORD will be sent after your user registration information is confirmed.</p> |

(continued on next page)

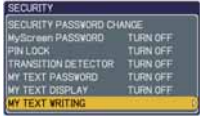
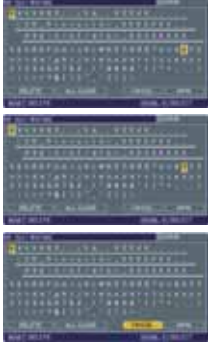



OPTION menu (continued)

| Item                                   | Description  |
|--|--|
| <p><b>SECURITY</b><br/>(continued)</p> | <p><b>5. Using the MY TEXT PASSWORD function</b><br/>This item allows you to display your own message (MY TEXT) on the START UP screen and INPUT-INFORMATION. It can be protected by a password to prevent it from being overwritten.</p> <p><b>5.1 Writing the MY TEXT</b></p> <p>(1) Use the ▲/▼ buttons on the SECURITY menu to select the MY TEXT WRITING menu and press the ► button. The MY TEXT WRITING dialog will be displayed.</p>  <p>(2) The current MY TEXT will be displayed on the first 3 lines. If not yet written, the lines will be blank. Use the ▲/▼/◀/▶ buttons and the ENTER or INPUT button to select and enter characters. The RESET button can be used to erase 1 character at a time. Also if you move the cursor to DELETE or ALL CLEAR on screen and push the ENTER or INPUT button, 1 character or all characters will be erased. The MY TEXT can be input up to 24 characters on each line.</p> <p>(3) To change an already inserted character, press the ▲/▼ button to move the cursor to one of the first 3 lines, and use the ◀/▶ buttons to move the cursor on the character to be changed. After pressing the ENTER or INPUT button, the character is selected. Then, follow the same procedure as described at the item (2) above.</p>  <p>(4) To finish entering text, move the cursor to the SAVE on screen and press the ENTER or INPUT button. To revert to the previous MY TEXT without saving changes, move the cursor to the CANCEL on screen and press the ENTER or INPUT button.</p> <ul style="list-style-type: none"> <li>• The MY TEXT WRITING function is available only when the MY TEXT PASSWORD function is set to TURN OFF.</li> </ul> <p><b>5.2 Displaying the MY TEXT</b></p> <p>(1) Use the ▲/▼ buttons on the SECURITY menu to select the MY TEXT DISPLAY menu and press the ► button to display the MY TEXT DISPLAY on/off menu.</p>  <p>MY TEXT DISPLAY on/off menu</p> <p>(2) Use the ▲/▼ buttons on the MY TEXT DISPLAY on/off menu to select on or off.</p> <p>TURN ON ⇔ TURN OFF</p> <p>When it is set TURN ON, the MY TEXT will be displayed on the START UP screen. Whichever is selected, the MY TEXT will be displayed on the INPUT-INFORMATION when the INFORMATION on the SERVICE menu is chosen.</p>  <ul style="list-style-type: none"> <li>• This function is available only when the MY TEXT PASSWORD function is set to the TURN OFF.</li> </ul> |

(continued on next page)

OPTION menu

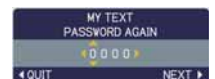
OPTION menu (continued)

| Item                                   | Description  |
|--|--|
| <p><b>SECURITY</b><br/>(continued)</p> | <p><b>5.3 Turning on the MY TEXT PASSWORD</b><br/>The MY TEXT PASSWORD function can prevent the MY TEXT from being overwritten.</p> <p>5.3-1 Turning on the MY TEXT PASSWORD function</p> <p>(1) Use the ▲/▼ buttons on the SECURITY menu to select the MY TEXT PASSWORD menu and press the ► button to display the MY TEXT PASSWORD on/off menu.</p>  <p>MY TEXT PASSWORD</p> <p>5.3-2 Setting the MY TEXT PASSWORD</p> <p>(1) Display the MY TEXT PASSWORD on/off menu using the procedure in 5.3-1</p>  <p>ENTER PASSWORD BOX (small)</p> <p>(2) Use the ▲/▼ buttons on the MY TEXT PASSWORD menu to select TURN ON. The ENTER PASSWORD BOX (small) will be displayed.</p>  <p>PASSWORD AGAIN BOX</p> <p>(3) Use the ▲/▼/◀/▶ buttons to enter the PASSWORD. Move the cursor to the right side of the ENTER PASSWORD BOX (small) and press the ► button to display the PASSWORD AGAIN BOX, and then enter the same PASSWORD again.</p>  <p>NOTE PASSWORD BOX</p> <p>(4) Move the cursor to the right side of the PASSWORD AGAIN BOX and press ► button to display the PASSWORD for about 20 seconds, then please make note of the PASSWORD during this time.</p> <p>Pressing the <b>ENTER</b> button on the remote control or <b>INPUT</b> button on the projector will return to the MY TEXT PASSWORD on/off menu. When the PASSWORD is set for the MY TEXT;</p> <ul style="list-style-type: none"> <li>• The MY TEXT DISPLAY menu will be unavailable, which can prohibit changing the DISPLAY setting.</li> <li>• The MY TEXT WRITING menu will be unavailable, which can prevent the MY TEXT from being overwritten.</li> </ul> <p>5.3-3 Turning the MY TEXT PASSWORD off</p> <p>(1) Follow the procedure in 5.3-1 to display the MY TEXT PASSWORD on/off menu.</p>  <p>ENTER PASSWORD BOX (large)</p> <p>(2) Select TURN OFF to display the ENTER PASSWORD BOX (large). Enter the registered PASSWORD and the screen will return to the MY TEXT PASSWORD on/off menu.</p> <p>If an incorrect PASSWORD is input, the menu will close. If necessary, repeat the process from 5.3-3(1)</p> <p>5.3.4 If you have forgotten your PASSWORD.</p> <p>(1) Follow the procedure in 5.3-1 to display the MY TEXT PASSWORD on/off menu.</p> <p>(2) Select TURN OFF to display the ENTER PASSWORD BOX (large). The 10 digit inquiring code will be displayed inside the box.</p> <p>(3) Contact your dealer with the 10 digit inquiring code. Your PASSWORD will be sent after your user registration information is confirmed.</p> |

**NETWORK menu**

**NETWORK menu**

Remember that incorrect network settings on this projector may cause trouble on the network. Be sure to consult with your network administrator before connecting to an existing access point on your network.





Select "NETWORK" from the main menu to access the following functions.

Select an item using the ▲/▼ cursor buttons on the projector or remote control, and press the ► cursor button on the projector or remote control, or **ENTER** button on the remote control to execute the item. Then perform it according to the following table.

See the User's Manual - Network Guide for details of NETWORK operation.

**NOTE** • The factory default setting for DHCP is OFF. If your network has DHCP enabled, and needs to set IP ADDRESS, SUBNET MASK and DEFAULT GATEWAY automatically, please set DHCP to ON. ([📖 Network Settings of the User's Manual - Network Guide](#))







• If you are not utilizing SNTP ([📖 Date/Time Settings of the User's Manual - Network Guide](#)), then you must set the DATE AND TIME ([📖 57](#)) during the initial installation.

| Item                | Description  |   |
|---------------------|--|---|
| <p><b>SETUP</b></p> |  | <p>Selecting this item displays the SETUP menu for the network.<br/>Use the ▲/▼ buttons to select an item, and the ► or <b>ENTER</b> button on the remote control to perform the item.</p>   |
|                     | <p><b>DHCP</b><br/>(Dynamic Host Configuration Protocol)</p> | <p>Use the ▲/▼ buttons to turn DHCP on/off.<br/>ON ⇔ OFF</p> <p>Select OFF when the network does not have DHCP enabled.</p> <ul style="list-style-type: none"> <li>• When the "DHCP" setting changes to "ON", it takes a little time to obtain IP address from DHCP server.</li> <li>• Auto IP function will be assigned an IP address if the projector could not obtain an IP address from server even if DHCP is "ON".</li> </ul>  |

(continued on next page)

NETWORK menu



NETWORK menu (continued)

| Item                          | Description  |
|-------------------------------|--|
| <p><b>IP ADDRESS</b></p>      | <p>Use the ▲/▼/◀/▶ buttons to enter the IP ADDRESS. This function can only be used when DHCP is set to OFF.</p>  <ul style="list-style-type: none"> <li>• The IP ADDRESS is the number that identifies this projector on the network. You cannot have two devices with the same IP ADDRESS on the same network.</li> <li>• The IP ADDRESS "0.0.0.0" is prohibited.</li> </ul> |
| <p><b>SUBNET MASK</b></p>     | <p>Use the ▲/▼/◀/▶ buttons to enter the same SUBNET MASK used by your PC. This function can only be used when DHCP is set to OFF.</p>  <ul style="list-style-type: none"> <li>• The SUBNET MASK "0.0.0.0" is prohibited.</li> </ul>   |
| <p><b>DEFAULT GATEWAY</b></p> | <p>Use the ▲/▼/◀/▶ buttons to enter the DEFAULT GATEWAY (a node on a computer network that serves as an access point to another network) address. This function can only be used when DHCP is set to OFF.</p>    |
| <p><b>DNS SERVER</b></p>      | <p>Use the ▲/▼/◀/▶ buttons to input the DNS server address. The DNS server is a system to control domain names and IP addresses on the Network.</p>   |
| <p><b>TIME DIFFERENCE</b></p> | <p>Use the ▲/▼ buttons to enter the TIME DIFFERENCE. Set the same TIME DIFFERENCE as the one set on your PC. If unsure, consult your IT manager. Use the ◀ button to return to the menu after setting the TIME DIFFERENCE.</p>    |
| <p><b>DATE AND TIME</b></p>   | <p>Use the ▲/▼/◀/▶ buttons to enter the Year (last two digits), Month, Date, Hour and Minute.</p>  <ul style="list-style-type: none"> <li>• The projector will override this setting and retrieve DATE AND TIME information from the Time server when SNTP is enabled. (📖 <b>Date/Time Settings of the User's Manual - Network Guide</b>)</li> </ul>                        |

(continued on next page)





NETWORK menu (continued)

| Item   | Description   |
|--|---|
| <p style="text-align: center;"><b>PROJECTOR NAME</b></p> | <p>(1) Use the ▲/▼ buttons on the NETWORK menu to select the PROJECTOR NAME menu and press the ► button. The PROJECTOR NAME dialog will be displayed.</p> <p>(2) The current PROJECTOR NAME will be displayed on the first 3 lines. If not yet written, the lines will be blank. Use the ▲/▼/◀/► buttons and the <b>ENTER</b> or <b>INPUT</b> button to select and enter characters. The <b>RESET</b> button can be used to erase 1 character at a time. Also if you move the cursor to <b>DELETE</b> or <b>ALL CLEAR</b> on screen and push the <b>ENTER</b> or <b>INPUT</b> button, 1 character or all characters will be erased. The PROJECTOR NAME can be input up to 64 characters.</p> <p>(3) To change an already inserted character, press the ▲/▼ button to move the cursor to one of the first 3 lines, and use the ◀/► buttons to move the cursor on the character to be changed. After pressing the <b>ENTER</b> or <b>INPUT</b> button, the character is selected. Then, follow the same procedure as described at the item (2) above.</p> <p>(4) To finish entering text, move the cursor to the <b>SAVE</b> on screen and press the <b>ENTER</b> or <b>INPUT</b> button. To revert to the previous PROJECTOR NAME without saving changes, move the cursor to the <b>CANCEL</b> on screen and press the <b>ENTER</b> or <b>INPUT</b> button.</p> <div style="display: flex; justify-content: space-around; align-items: flex-start;">    </div> |

(continued on next page)



**NETWORK menu**

**NETWORK menu (continued)**

| Item                 | Description  |
|----------------------|--|
| <p><b>e-SHOT</b></p> | <p>Selecting this item displays the e-SHOT menu.<br/>                     The application software "PJTransfer" is required to store image(s) into the projector.</p>  <p>Use the ▲/▼ buttons to select an item which is a still image by the e-SHOT (<a href="#">e-SHOT (Still Image Transfer) Display of the User's Manual - Network Guide</a>) and the ► or <b>ENTER</b> button to display the image.</p> <ul style="list-style-type: none"> <li>• The item without image stored cannot be selected.</li> <li>• The image names are each displayed in 16 characters or less.</li> </ul> <p><b>To switch the image displayed</b><br/>                     Use the ▲/▼ buttons.</p> <p><b>To return to the menu</b><br/>                     Press the ◀ or <b>ESC</b> button on the remote control.</p> <p><b>To erase the image displayed and its source file in the projector.</b></p> <p>(1) Press the <b>RESET</b> button on the remote control while displaying an image to display the e-SHOT - RESET menu.</p>  <p>(2) Press the <b>ENTER</b> button on the remote control or the <b>INPUT</b> button on the projector to perform to erase.<br/>                     To stop erasing, press the <b>ESC</b> button on the remote control or the ◀ button on the projector.</p> |

(continued on next page)

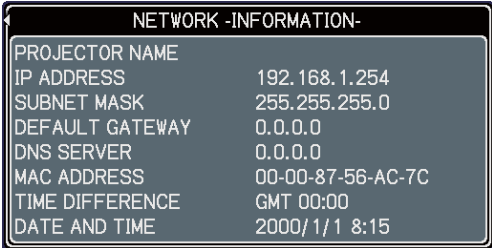
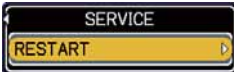
NETWORK menu (continued)

| Item                      | Description   |
|---------------------------|---|
| <p><b>INFORMATION</b></p> | <p>Selecting this item displays the NETWORK -INFORMATION- dialog for confirming the network settings.</p>  <ul style="list-style-type: none"> <li>• The PROJECTOR NAME is displayed.</li> <li>• Nothing (blank) is shown in the “PROJECTOR NAME” field until you setup the item (57).</li> <li>• When the voltage level of the battery for the built in clock decreases, the set time may become incorrect even though accurate date and time are input. Replace the battery suitably (65).</li> <li>• IP ADDRESS, SUBNET MASK and DEFAULT GATEWAY indicate “0.0.0.0” when DHCP is ON and the projector has not gotten address from DHCP server.</li> </ul> |
| <p><b>SERVICE</b></p>     | <p>Executing this item restarts and initializes the network functions. Choose the RESTART using the button ►.</p>  <p>Then use the button ▲ to execute.</p>  <p>Network will be once cut off when choose restart. If DHCP is selected on, IP address may be changed. After selecting RESTART, NETWORK menu may not be controlled approx. 30 seconds.</p>  |





**C.C. (Closed Caption) menu**

**C.C. (Closed Caption) menu**

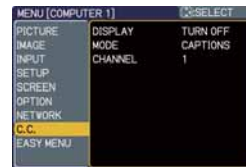
The closed caption setting can be changed through C.C. menu in the advance menu. Please select the item that you will change using ▲/▼ cursor buttons.

- The C.C. (Closed Caption) is the function that displays a transcript or dialog of the audio portion of a video, files or other presentation or other relevant sounds. It is required to have NTSC format video or 525i(480i) Component video source supporting C.C. feature to utilize this function.

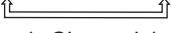

| Item                  | Description   |
|-----------------------|---|
| <p><b>DISPLAY</b></p> | <p>Select Closed Caption DISPLAY setting from following options using ▲/▼ buttons.</p> <p>TURN OFF ⇔ TURN ON ⇔ AUTO</p>  <p>TURN OFF: Closed Caption is OFF<br/>           TURN ON: Closed Caption is ON<br/>           AUTO: Closed Caption automatically displays when the volume is muted.</p> <ul style="list-style-type: none"> <li>• The caption is not displayed when the OSD menu is active.</li> <li>• The Closed Caption is the function to display the dialogue, narration, and / or sound effects of a television program or other video sources. The Closed Caption availability is depending upon broadcaster and/or content.</li> <li>• The caption is available if the video source is NTSC format and the video format selection is AUTO or NTSC on the INPUT menu, when either VIDEO or S-VIDEO is selected as input port.</li> <li>• The caption is also available if 525i(480i) video signal is input from COMPONENT port, when it is selected as input port.</li> <li>• It may not work properly, depending on equipment or signal source. In this case, please turn off the Closed Caption.</li> </ul>  |
| <p><b>MODE</b></p>    | <p>Select Closed Caption MODE setting from following options using ▲/▼ buttons.</p> <p>CAPTIONS ⇔ TEXT</p> <p>CAPTIONS: Display Closed Caption<br/>           TEXT: Display Text data, which is for additional information such as news reports or a TV program guide. The information covers the entire screen. Not all of the C.C. program has Text information.</p>   |
| <p><b>CHANNEL</b></p> | <p>Select Closed Caption CHANNEL from following options using ▲/▼ buttons.</p> <p>1 ⇔ 2 ⇔ 3 ⇔ 4</p>  <p>1: Channel 1, primary channel / language<br/>           2: Channel 2<br/>           3: Channel 3<br/>           4: Channel 4</p> <p>The channel data may vary, depending on the content. Some channel might be used for secondary language or empty.</p>    |

Maintenance

Replacing the lamp

The projection lamp has finite product life that is different in each lamp. Please replace the lamp as soon as possible when the pictures appear dark, or when the color tone is poor. Using the lamp for long periods of time may make the lamp burned out or broken. Preparation of a spare lamp and early replacement are recommended. To prepare the new lamp, call your dealer and tell the type number: **DT00891**

1. Turn the projector off and unplug the power cord from the power outlet. And cool the projector down by leaving it for about 45 minutes as it is.

When the projector is mounted on a ceiling or somewhere over your head, or when the lamp may have been broken, be sure to refer replacement to your dealer or service person, since it may be dangerous.

Only in case of replacement by yourself, follow the following procedure.

2. Loosen the screw (marked by arrow) of the lamp cover, and then slide the lamp cover to the side to remove it.
3. Loosen the 2 screws (marked by arrows) of the lamp, and slowly pick up the lamp by the handles.
4. Insert the new lamp, with cautions not to touch the inside of the lamp house. When inserting, pay attention to the socket position first, and to the pins for positioning next.
5. Tighten firmly the 2 screws of the lamp that are loosened in the previous process to lock it in place.
6. Slide the lamp cover into place and firmly tighten the screw of the lamp cover.
7. Plug in and restart the projector (12, 16). Then, reset the lamp time (which is the time counter for the lamp use).

(1) Press the ▲ or ▼ button on the projector or the **MENU** button on the remote control. The "EASY MENU" appears.

(2) Point at the "Go to Advanced Menu ..." in the menu using the ▲ or ▼ button, then press the ► button. "MENU" appears.

(3) Pointed at the "OPTION" in the left column using the ▲ or ▼ button, then press the ► button. The cursor moves to the right column.

(4) Pointed at the "LAMP TIME" using the ▲ or ▼ button, then press the ► button. A dialog appears.

(5) Press the ▲ button to select the "RESET" on the dialog. It performs resetting the lamp time.

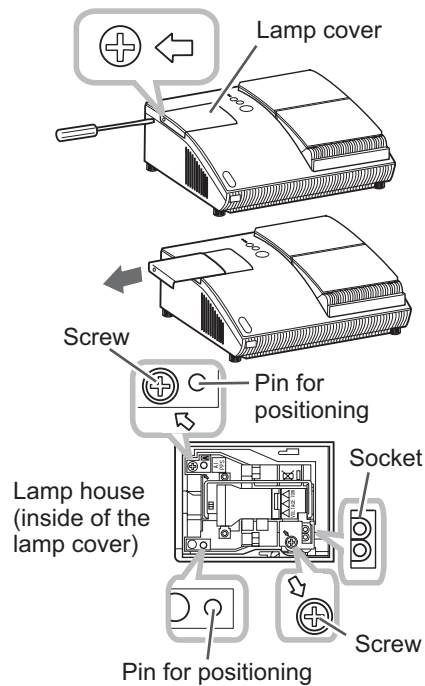



Maintenance

Replacing the lamp (continued)

**NOTE** • Please reset the lamp time only when you have replaced the lamp, for a suitable indication about the lamp.

**⚠ HIGH VOLTAGE    ⚠ HIGH TEMPERATURE    ⚠ HIGH PRESSURE**

**⚠ WARNING** ► The projector uses a high-pressure mercury glass lamp. The lamp can break with a loud bang, or burn out, if jolted or scratched, handled while hot, or worn over time. Note that each lamp has a different lifetime, and some may burst or burn out soon after you start using them. In addition, when the bulb bursts, it is possible for shards of glass to fly into the lamp housing, and for gas containing mercury to escape from the projector's vent holes.  
**About disposal of a lamp:** This product contains a mercury lamp; do not put it in a trash. Dispose of it in accordance with environmental laws.  
 • For lamp recycling, go to [www.lamprecycle.org](http://www.lamprecycle.org) (in the US).  
 • For product disposal, contact your local government agency or [www.eiae.org](http://www.eiae.org) (in the US) or [www.epsc.ca](http://www.epsc.ca) (in Canada).  
 For more information, call your dealer.

- 
  - If the lamp should break (it will make a loud bang when it does), unplug the power cord from the outlet, and make sure to request a replacement lamp from your dealer. Note that shards of glass could damage the projector's internals, or cause injury during handling, so please do not try to clean the projector or replace the lamp yourself.
  - If the lamp should break (it will make a loud bang when it does), ventilate the room well, and make sure not to breathe the gas that comes out of the projector vents or get it in your eyes or mouth.
  - Before replacing the lamp, turn the projector off and unplug the power cord, then wait for at least 45 minutes for the lamp to cool sufficiently. Handling the lamp while hot can cause burns, as well as damaging the lamp.
- 
  - Never unscrew except the appointed (marked by an arrow) screw.
  - Do not open the lamp cover while the projector is suspended from a ceiling or somewhere over your head. This is dangerous, since if the lamp's bulb has broken, the shards will fall out when the cover is opened. In addition, working in high places is dangerous, so ask your local dealer to have the lamp replaced even if the bulb is not broken.
  - Do not use the projector with the lamp cover removed. At the lamp replacing, make sure that the screws are screwed in firmly. Loose screws could result in damage or injury.
- 
  - Use only the lamp of the specified type.
  - If the lamp breaks soon after the first time it is used, it is possible that there are electrical problems elsewhere besides the lamp. If this happens, contact your local dealer or service representative.
  - Handle with care: jolting or scratching could cause the lamp bulb to burst during use.
  - Using the lamp for long periods of time, could cause it dark, not to light up or to burst. When the pictures appear dark, or when the color tone is poor, please replace the lamp as soon as possible. Do not use old (used) lamps; this is a cause of breakage.

## Maintaining the air-filter

Please check and clean the air-filter periodically, for keeping normal ventilation. When the indicators or a message prompts you to clean the air-filter, comply with it as soon as possible.

When it is damaged or too soiled, replace the filter unit. To prepare the new filter unit, call your dealer and tell the type number: **QD60122**

1. Turn the projector off and unplug the power cord from the power outlet. And cool the projector down by leaving it for a while as it is.
2. Use the vacuum cleaner on and around the filter unit.
3. Slide the filter unit upward to take it off from the projector.
4. Use the vacuum cleaner on the intake vents of the projector.
5. Use the vacuum cleaner on the cover side of the filter unit. Do not vacuum the air-filter directly, since the cleaner may inhale the air-filter. When the air-filter is damaged or too soiled, prepare the new filter unit.
6. Make sure that there is the air-filter inside, then slide the filter cover into place.
7. Plug in and restart the projector (📖 12, 16).

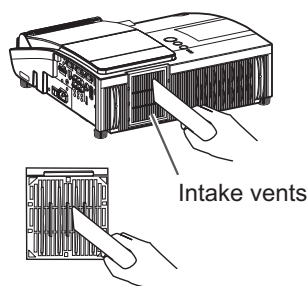
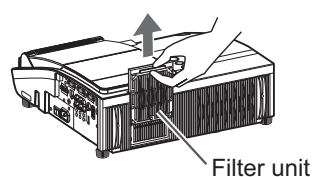

- Then, reset the filter time (which is the time counter for the air-filter use).
- (1) Press the ▲ or ▼ button on the projector or the **MENU** button on the remote control. The "EASY MENU" appears.
  - (2) Point at the "FILTER TIME" in the menu using the ▲ or ▼ button, then press the ► button. A dialog appears.
  - (3) Press the ▲ button to select the "RESET" on the dialog. It performs resetting the filter time.

(continued on next page)

## Maintenance

### *Maintaining the air-filter (continued)*

**NOTE** • A filter unit of specified type will come with the replacement lamp for this projector. Replacing the filter unit at the same time with the lamp is recommended.

- Please reset the filter time only when you have cleaned the air-filter, for a suitable indication about the air-filter.
- The projector may display the message such as “CHECK THE AIR FLOW” or turn off the projector, to prevent the internal heat level rising.

**⚠ WARNING** ▶ Before taking care of the air-filter, make sure the power switch is off and the power cable is not plugged in, then allow the projector to cool sufficiently. Taking care of the air-filter in a high temperature state of the projector could cause an electric shock, a burn or malfunction to the projector.

▶ Use only the air-filter unit of the specified type. Do not use the projector without the air-filter or the filter cover. It could result in a fire or malfunction to the projector.

▶ Clean the air-filter periodically. If the air-filter becomes clogged by dust or the like, internal temperatures rise and could cause a fire, a burn or malfunction to the projector.



## Replacing the clock battery

This projector has internal clock that uses a battery. When the clock of the network function does not work correctly, please try solution by replacement of the battery: **HITACHI MAXELL**, part number **CR2032**.

1. Turn the projector off and unplug the power cord from the power outlet. And cool the projector down by leaving it for a while as it is.
2. Place gently the projector upside down.
3. Remove the battery cover. Turn the battery cover in the direction indicated as **"OPEN"** till it unlocks using a coin or something similar. When finishing turning the battery cover, pick its knob to remove it.
4. Take the old battery out. Press the metal claw of the battery holder. Then the battery will come up. Remove it.
5. Put the new battery into the battery holder, according to the polarity markings (-) inside the holder, so that the side marked (+) of the battery is facing upward. Push the battery into the battery holder fully to fix.
6. Put the battery cover into place, then turn it in the direction indicated as **"CLOSE"** until it fixed, using a coin or something similar.

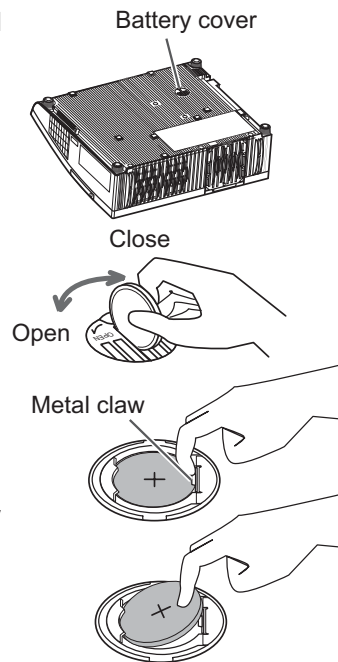

**NOTE** • The internal clock will be initialized by removing the battery. For setting the clock, see the User's Manual - Network Guide.

- ⚠ WARNING** ► Be careful of handling a battery, as a battery can cause explosion, cracking or leakage, which could result in a fire, an injury, and environment pollution.
- Use only the specified and perfect battery. Do not use a battery with damage, such as a scratch, a dent, rust or leakage.
  - When a battery leaked, wipe the leakage out well with a waste cloth. If the leakage adhered to your body, immediately rinse it well with water. When a battery leaked in the battery holder, replace the batteries after wiping the leakage out.
  - Make sure the plus and minus terminals are correctly aligned when loading a battery.
  - Do not work on a battery; for example recharging or soldering.
  - Keep a battery in a dark, cool and dry place. Never expose a battery to a fire or water.
  - Obey the local laws on disposing a battery.

Maintenance

### Caring for the mirror and lens

If the projection mirror or lens is flawed, soiled or fogged, it could cause deterioration of display quality. Please take care of the mirror and lens, being cautious of handling.

1. Turn the projector off and unplug the power cord from the power outlet. And cool the projector down by leaving it for a while as it is.
2. The lens door can be opened manually. Please hold both side of the lens door and slowly open it until it is locked with clicking sound.
3. Wipe softly the mirror and lens with a cleaning cloth for lens on the market, being careful not to give any damage on the mirror and lens. For around edge of the mirror and lens where might be difficult to be wiped out, please use an air blower for cameras on the market to clean up.
4. To close the lens door properly, please take the following procedure.
  - (1) Plug in the projector.
  - (2) Turn on the power switch.
  - Even though the lens door starts to close, it might not be closed properly.
  - (3) Press the **STANDBY/ON** button, so that the lamp starts to light up.
  - (4) After the **POWER** indicator turns to steady green, press the **STANDBY/ON** button twice to turn off the projector.
  - The lens door will close properly.

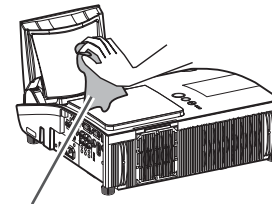
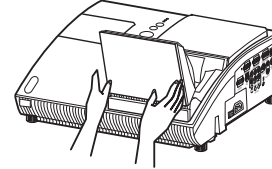
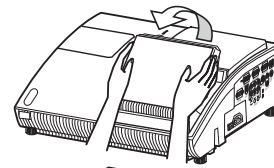

Cleaning cloth

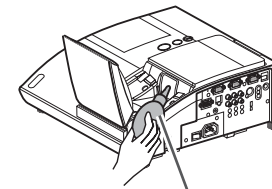

Blower

**NOTE** • When the lens door is closed manually, it may not shut properly.

⚠ **WARNING** ▶ Before caring for the projection mirror and lens, turn the projector off and unplug the power cord, then cool the projector sufficiently.  
 ▶ Do not use a vacuum cleaner to clean the projection mirror or lens, since it might give some damage.  
 ▶ Do not use cleaners or chemicals other than those specified in this manual. Especially the mirror has to be paid special attention, since these materials might give serious damage on the mirror.

⚠ **CAUTION** ▶ Be careful not to pinch your finger with the lens door, to prevent an injury.

## Other care

### Inside of the projector

In order to ensure the safe use of your projector, please have it cleaned and inspected by your dealer about once every year.

### Caring for the cabinet and remote control

Incorrect care could have adverse influence such as discoloration, peeling paint, etc.

1. Turn the projector off, and unplug the power cord. Allow the projector to cool sufficiently.
2. After making sure that the projector is cool adequately, lightly wipe with gauze or a soft cloth.  
If the projector is extremely dirty, dip soft cloth in water or a neutral cleaner diluted in water, and wipe lightly after wringing well. Then, wipe lightly with a soft, dry cloth.

**⚠ WARNING** ▶ Before caring, make sure the power cord is not plugged in, and then allow the projector to cool sufficiently. The care in a high temperature state of the projector could cause a burn and/or malfunction to the projector.

▶ Never try to care for the inside of the projector personally. Doing is so dangerous.

▶ Avoid wetting the projector or inserting liquids in the projector. It could result in a fire, an electric shock, and/or malfunction to the projector.

- Do not put anything containing water, cleaners or chemicals near the projector.
- Do not use aerosols or sprays.

**⚠ CAUTION** ▶ Please take right care of the projector according to the following. Incorrect care could cause not only an injury but adverse influence such as discoloration, peeling paint, etc.

- ▶ Do not use cleaners or chemicals other than those specified in this manual.
- ▶ Do not polish or wipe with hard objects.

Troubleshooting

Troubleshooting

If an abnormal operation should occur, stop using the projector immediately.





**⚠ WARNING ▶** Never use the projector if abnormal operations such as smoke, strange odor, excessive sound, damaged casing or elements or cables, penetration of liquids or foreign matter, etc. should occur. In such cases, immediately turn off the power switch and then disconnect the power plug from the power outlet. After making sure that the smoke or odor has stopped, contact to your dealer or service company.

Otherwise if a problem occurs with the projector, the following checks and measures are recommended before requesting repair.

If this does not resolve the problem, please contact your dealer or service company. They will tell you what warranty condition is applied.

**Related messages**

When some message appears, check and cope with it according to the following table. Although these messages will be automatically disappeared around several minutes, it will be reappeared every time the power is turned on.

| Message   | Description   |
|---|---|
|  | <p><b>There is no input signal.</b><br/>Please confirm the signal input connection, and the status of the signal source.</p>  |
|  | <p><b>The horizontal or vertical frequency of the input signal is not within the specified range.</b><br/>Please confirm the specs for your projector or the signal source specs.</p>   |
|  | <p><b>The internal temperature is rising.</b><br/>Please turn the power off, and allow the projector to cool down at least 20 minutes. After having confirmed the following items, please turn the power ON again.</p> <ul style="list-style-type: none"> <li>• Is there blockage of the air passage aperture?</li> <li>• Is the air-filter dirty?</li> <li>• Does the peripheral temperature exceed 35°C?</li> </ul> <p>If the same indication is displayed after the remedy, please set FAN SPEED of the SERVICE item in the OPTION menu to HIGH.</p> |
|  | <p><b>A note of precaution when cleaning the air-filter.</b><br/>Please immediately turn the power off, and clean or change the air-filter referring to the “Maintaining the air-filter” section of this manual. After you have cleaned or changed the air-filter, please be sure to reset the filter time (43, 63).</p>  |

## Regarding the indicator lamps

When operation of the **LAMP**, **TEMP** and **POWER** indicators differs from usual, check and cope with it according to the following table.

| POWER indicator   | LAMP indicator                   | TEMP indicator                   | Description  |
|---|----------------------------------|----------------------------------|--|
| Lighting<br>In <b>Orange</b>  | Turned<br>off                    | Turned<br>off                    | <b>The projector is in a standby state.</b><br>Please refer to the section "Power on/off".   |
| <i>Blinking</i><br>In <b>Green</b>                                  | Turned<br>off                    | Turned<br>off                    | <b>The projector is warming up.</b><br>Please wait.  |
| Lighting<br>In <b>Green</b>   | Turned<br>off                    | Turned<br>off                    | <b>The projector is in an on state.</b><br>Ordinary operations may be performed.   |
| <i>Blinking</i><br>In <b>Orange</b>                                 | Turned<br>off                    | Turned<br>off                    | <b>The projector is cooling down.</b><br>Please wait.  |
| <i>Blinking</i><br>In <b>Red</b>                                    | (discre-<br>tionary)             | (discre-<br>tionary)             | <b>The projector is cooling down. A certain error has been detected.</b><br>Please wait until <b>POWER</b> indicator finishes blinking, and then perform the proper measure using the item descriptions below.   |
| <i>Blinking</i><br>In <b>Red</b><br>or<br>Lighting<br>In <b>Red</b> | Lighting<br>In <b>Red</b>        | Turned<br>off                    | <b>The lamp does not light, and there is a possibility that interior portion has become heated.</b><br>Please turn the power off, and allow the projector to cool down at least 20 minutes. After the projector has sufficiently cooled down, please make confirmation of the following items, and then turn the power on again.<br><ul style="list-style-type: none"> <li>• Is there blockage of the air passage aperture?</li> <li>• Is the air-filter dirty?</li> <li>• Does the peripheral temperature exceed 35°C?</li> </ul> If the same indication is displayed after the remedy, please change the lamp referring to the section "Lamp". |
| <i>Blinking</i><br>In <b>Red</b><br>or<br>Lighting<br>In <b>Red</b> | <i>Blinking</i><br>In <b>Red</b> | Turned<br>off                    | <b>The lamp cover has not been properly fixed.</b><br>Please turn the power off, and allow the projector to cool down at least 45 minutes. After the projector has sufficiently cooled down, please make confirmation of the attachment state of the lamp cover. After performing any needed maintenance, turn the power on again. If the same indication is displayed after the remedy, please contact your dealer or service company.  |
| <i>Blinking</i><br>In <b>Red</b><br>or<br>Lighting<br>In <b>Red</b> | Turned<br>off                    | <i>Blinking</i><br>In <b>Red</b> | <b>The cooling fan is not operating.</b><br>Please turn the power off, and allow the projector to cool down at least 20 minutes. After the projector has sufficiently cooled down, please make confirmation that no foreign matter has become caught in the fan, etc., and then turn the power on again. If the same indication is displayed after the remedy, please contact your dealer or service company.  |
| Lighting<br>In <b>Red</b>   | Turned<br>off                    | Turned<br>off                    | <b>The lens door is not opened or closed properly.</b><br>One of the followings has been happened.<br><ul style="list-style-type: none"> <li>• The lens door is not opened properly, when the projector is turned on.</li> <li>• The lens door is not closed properly, when the projector is turned off.</li> <li>• The lens door position is shifted, while the projector is working.</li> </ul> Restart the projector, after confirming that there is nothing that the lens door hits while opening or closing.  |

(Continued on next page)

**Troubleshooting**

**Regarding the indicator lamps (continued)**

| POWER indicator                                  | LAMP indicator                      | TEMP indicator         | Description  |
|--|-------------------------------------|------------------------|--|
| Blinking In <b>Red</b> or Lighting In <b>Red</b> | Turned off                          | Lighting In <b>Red</b> | <p><b>There is a possibility that the interior portion has become heated.</b></p> <p>Please turn the power off, and allow the projector to cool down at least 20 minutes. After the projector has sufficiently cooled down, please make confirmation of the following items, and then turn the power on again.</p> <ul style="list-style-type: none"> <li>• Is there blockage of the air passage aperture?</li> <li>• Is the air-filter dirty?</li> <li>• Does the peripheral temperature exceed 35°C?</li> </ul> <p>If the same indication is displayed after the remedy, please set FAN SPEED of SERVICE item in OPTION menu to HIGH (45).</p> |
| Lighting In <b>Green</b>                         | Simultaneous blinking in <b>Red</b> |                        | <p><b>It is time to clean the air-filter.</b></p> <p>Please immediately turn the power off, and clean or change the air-filter referring to the section “Maintaining the air-filter”. After cleaning or changing the air-filter, please be sure to reset the filter timer. After the remedy, reset the power to ON.</p>  |
| Lighting In <b>Green</b>                         | Alternative blinking in <b>Red</b>  |                        | <p><b>There is a possibility that the interior portion has become overcooled.</b></p> <p>Please use the unit within the usage temperature parameters (5°C to 35°C). After the treatment, reset the power to ON.</p>  |
| Blinking in <b>Green</b> for approx. 3 seconds   | Turned off                          | Turned off             | <p><b>At least 1 Power ON schedule is saved to the projector.</b></p> <p>Please refer to “Schedule Settings” section of User’s Manual-Network Guide.</p>   |

**NOTE** • When the interior portion has become overheated, for safety purposes, the projector is automatically shut down, and the indicator lamps may also be turned off. In such a case, disconnect the power cord, and wait at least 45 minutes. After the projector has sufficiently cooled down, please make confirmation of the attachment state of the lamp and lamp cover, and then turn the power on again.

**Shutting the projector down**

Only when the projector can not be turned off by usual procedure (17), please push the shutdown switch using a pin or similar, and disconnect the power plug from the power outlet. Before turning it on again, wait at least 10 minutes to make the projector cool down enough.

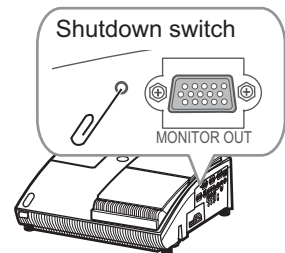

**Resetting all settings**

When it is hard to correct some wrong settings, the FACTORY RESET function of SERVICE item in OPTION menu (46) can reset all settings(except LANGUAGE, FILTER TIME, LAMP TIME, FILTER MESSAGE, NETWORK settings and etc.) to the factory default.

### Phenomena that may be easy to be mistaken for machine defects

About the phenomenon confused with a machine defect, check and cope with it according to the following table.

| Phenomenon                                 | Cases not involving a machine defect   | Reference page |
|--|--|----------------|
| Power does not come on.                    | <b>The electrical power cord is not plugged in.</b><br>Correctly connect the power cord.   | 12             |
|  | <b>The main power source has been interrupted during operation such as by a power outage (blackout), etc.</b><br>Please disconnect the power plug from the power outlet, and allow the projector to cool down at least 10 minutes, then turn the power on again.   | 12, 16         |
|  | <b>Either there is no lamp and/or lamp cover, or either of these has not been properly fixed.</b><br>Please turn the power off and disconnect the power plug from the power outlet, and allow the projector to cool down at least 45 minutes. After the projector has sufficiently cooled down, please make confirmation of the attachment state of the lamp and lamp cover, and then turn the power on again. | 61             |
| Neither sounds nor pictures are outputted. | <b>The signal cables are not correctly connected.</b><br>Correctly connect the connection cables.  | 10             |
|  | <b>Signal source does not correctly work.</b><br>Correctly set up the signal source device by referring to the manual of the source device.  | –              |
|  | <b>The input changeover settings are mismatched.</b><br>Select the input signal, and correct the settings.   | 18, 19         |
|  | <b>The BLANK function for pictures and the MUTE function for sounds are working.</b><br>The BLANK and MUTE, or AV Mute may be active. Refer to the item “Sound does not come out” and “No pictures are displayed” on the next page to turn off the MUTE and BLANK functions.   | 18, 23         |

(Continued on next page)

**Troubleshooting**

**Phenomena that may be easy to be mistaken for machine defects (continued)**

| Phenomenon                 | Cases not involving a machine defect   | Reference page |
|----------------------------|--|----------------|
| Sound does not come out.   | <b>The signal cables are not correctly connected.</b><br>Correctly connect the audio cables.   | 10             |
|                            | <b>The MUTE function is working.</b><br>Restore the sound pressing <b>MUTE</b> or <b>VOLUME</b> button on the remote control.  | 18             |
|                            | <b>The volume is adjusted to an extremely low level.</b><br>Adjust the volume to a higher level using the menu function or the remote control.                                     | 18             |
|                            | <b>The AUDIO/SPEAKER setting is not correct.</b><br>Correctly set the AUDIO/SPEAKER in SETUP menu.   | 37             |
| No pictures are displayed. | <b>The lens door is not fully opened.</b><br>Turn the projector off, and then turn it on again to make sure that the door is opened correctly.                                     | 16, 66         |
|                            | <b>The signal cables are not correctly connected.</b><br>Correctly connect the connection cables.  | 10             |
|                            | <b>The brightness is adjusted to an extremely low level.</b><br>Adjust BRIGHTNESS to a higher level using the menu function.   | 27, 28         |
|                            | <b>The computer cannot detect the projector as a plug and play monitor.</b><br>Make sure that the computer can detect a plug and play monitor using another plug and play monitor. | 11             |
|                            | <b>The BLANK screen is displayed.</b><br>Press <b>BLANK</b> button on the remote control.  | 23             |

(Continued on next page)



***Phenomena that may be easy to be mistaken for machine defects (continued)***

| Phenomenon  | Cases not involving a machine defect  | Reference page |
|---|---|----------------|
| Video screen display freezes.                               | <b>The FREEZE function is working.</b><br>Press <b>FREEZE</b> button to restore the screen to normal.   | 23             |
| Colors have a faded- out appearance, or Color tone is poor. | <b>Color settings are not correctly adjusted.</b><br>Perform picture adjustments by changing the COLOR TEMP, COLOR, TINT and/or COLOR SPACE settings, using the menu functions. | 27, 29, 33     |
|   | <b>COLOR SPACE setting is not suitable.</b><br>Change the COLOR SPACE setting to AUTO, RGB, SMPTE240, REC709 or REC601.   | 33             |
| Pictures appear dark.                                       | <b>The brightness and/or contrast are adjusted to an extremely low level.</b><br>Adjust BRIGHTNESS and/or CONTRAST settings to a higher level using the menu function.          | 27, 28         |
|   | <b>The WHISPER function is working.</b><br>Select NORMAL for WHISPER item in the SETUP menu.  | 27, 36         |
|   | <b>The lamp is approaching the end of its product lifetime.</b><br>Replace the lamp.  | 61, 62         |
| Pictures appear blurry.                                     | <b>Either the focus and/or horizontal phase settings are not properly adjusted.</b><br>Adjust the focus using the focus ring, and/or H PHASE using the menu function.           | 21, 32         |
|   | <b>The lens or mirror is dirty or misty.</b><br>Clean the lens or mirror referring to the section "Caring for the lens".  | 66             |

**NOTE** • Although bright spots or dark spots may appear on the screen, this is a unique characteristic of liquid crystal displays, and it does not constitute or imply a machine defect.

**Specifications**

**Specifications**

**Specifications**

| Item                 | Specifications   |   |
|----------------------|--|---|
| Product name         | Liquid crystal projector   |   |
| Liquid Crystal Panel | Panel size   | 1.6 cm (0.63 type)                              |
|                      | Drive system   | TFT active matrix                               |
|                      | Pixels   | 786,432 pixels (1024 horizontal x 768 vertical) |
| Lens                 | F=2.1 f=5.1 mm   |   |
| Lamp                 | 220 W UHB  |   |
| Audio output         | 7 W  |   |
| Power supply         | AC 100-120V/3.6A, AC 220-240V/1.5A   |   |
| Power consumption    | 340W   |   |
| Temperature range    | 5~35°C (operating)   |   |
| Ports                | COMPUTER IN1 ..... D-sub 15 pin mini x 1<br>COMPUTER IN2 ..... D-sub 15 pin mini x 1<br>Y, C <sub>B</sub> /P <sub>B</sub> , C <sub>R</sub> /P <sub>R</sub> (Component video) ..... RCA x 3<br>S-VIDEO ..... mini DIN 4 pin x 1<br>VIDEO ..... RCA x 1<br>MONITOR OUT ..... D-sub 15 pin mini x 1<br>AUDIO IN1 ..... Stereo mini x 1<br>AUDIO IN2 ..... Stereo mini x 1<br>AUDIO IN3 (L, R) ..... RCA x 2<br>AUDIO OUT ..... Stereo mini x 1<br>CONTROL ..... D-sub 9 pin x 1<br>USB ..... USB-B x 1<br>LAN ..... RJ45 Xx 1 |   |
| Optional parts       | Lamp: DT00891<br>Filter unit: QD60122<br>Tabletop use kit: TT100<br>Soft case: CA100<br>* For more information, contact to your dealer.  |   |
| Weight (mass)        | 5.8 kg (approx.)   |   |
| Size                 | 397 (W) x 131 (H) x 356 (D) mm<br>*Excluding protrusions. Please refer to the following figure.  |   |

Specifications

Specifications (continued)

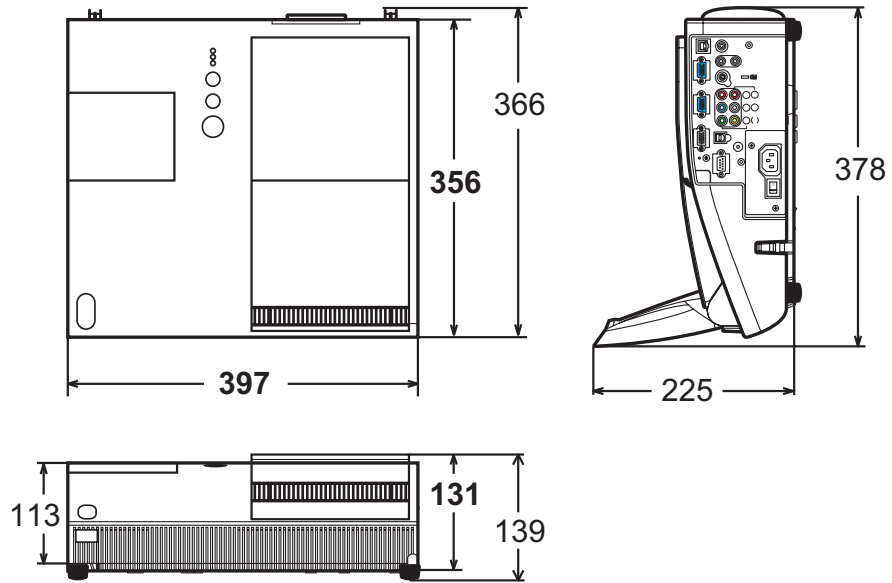

[unit: mm]