

Home Projector
EMP-TW700

User's Guide



About the Manuals and Notations Used

Types of Manual

The documentation for your EPSON projector is divided into the following two manuals. Refer to the manuals in the order given below.

① Safety Instructions/World-Wide Warranty Terms

This manual contains information on using the projector safely, and also includes a guide for warranty service, and a troubleshooting check sheet.







Be sure to read this manual thoroughly before using the projector.

② User's Guide (this manual)

This User's Guide contains information on installing the projector, basic operations, using the configuration menus, troubleshooting and maintenance.

Notations used in this User's Guide

General information

| | |
|--|--|
|  | Indicates procedures where personal injury or damage to the projector may occur if the procedures are not followed correctly. |
|  | Indicates additional information and points which may be useful to know regarding a topic. |
|  | Indicates a page where useful information regarding a topic can be found. |
|  | Indicates that an explanation of the underlined word or words in front of this symbol appears in the glossary of terms. Refer to the "Glossary" in the "Appendix".  p.52 |
|  ,  etc. | Indicates buttons on the remote control or projector's control panel. |
| " (Menu Name) " | Indicates configuration menu items. Example: "Picture"- "Color Mode" |
| [(Name)] | Indicates the port name of the projector. Example: [Video] |

Meaning of "unit" and "projector"

When "unit" or "projector" appears in the text of this *User's Guide*, they may refer to items which are accessories or optional equipment in addition to the main projector unit itself.

Checking the Components

When you unpack the projector, make sure that you have all these components.

If any of the components are missing or incorrect, please contact the place of purchase.

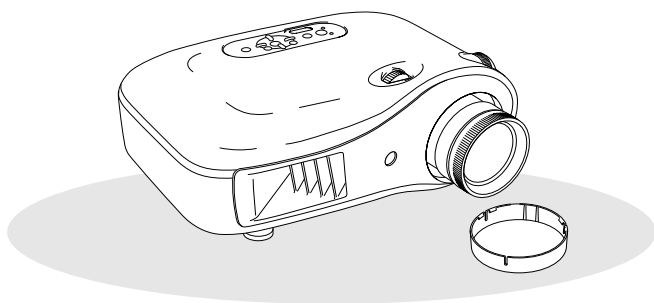

❑ **Projector (with lens cover)**

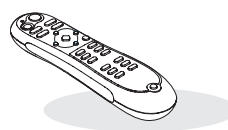

❑ **Remote control**

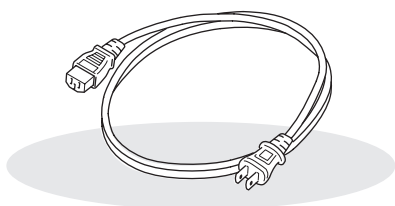

❑ **Power cable (3.0m)**
Connect to the projector and to a wall outlet.

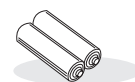

❑ **AA alkali batteries (2 pcs.)**
Insert into the remote control.

Documentation

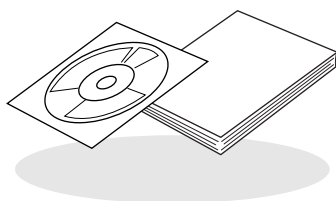

- ❑ **Document CD-ROM (Safety Instructions/World-Wide Warranty Terms, User's Guide)**
- ❑ **Quick Start Guide**
 - * Some regions may have paper manuals instead of a CD-ROM, or may not have the Quick Start Guide.

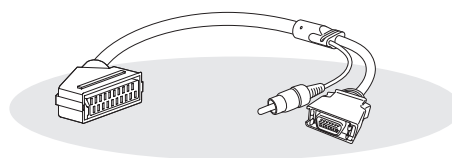

- ❑ **D SCART adapter**
 - Use a commercially-available SCART cable to make the connections when projecting RGB-video and component video images.
 - * Some regions may not have the D SCART adapter included as an accessory.

Table of Contents

| | | | |
|--|---|---------------------------|---|
| ■ Features of the Projector | 4 | Remote control | 7 |
| ■ Part Names and Functions | 6 | Rear..... | 8 |
| Front / Top..... | 6 | Base | 8 |
| Control panel | 6 | ■ Appearance | 9 |

Installing the Projector

| | | | |
|---|----|--|----|
| ■ Setting up | 10 | ■ Preparing the Remote Control | 13 |
| Adjusting the projection size..... | 10 | Inserting batteries into the remote control .. | 13 |
| ■ Connecting Image Sources | 12 | | |

Basic Operations

| | | | |
|---|----|---|----|
| ■ Projecting Images | 14 | ■ Adjusting the Projection Screen | 16 |
| Turning the power on and projecting images | 14 | Focus adjustment | 16 |
| | | Fine adjustments to image size (Zoom adjustment) | 16 |
| | | Projection image position adjustment (Lens shift)..... | 16 |



Image Quality Adjustments

| | | | |
|--|----|---|----|
| ■ Basic Image Quality Adjustments | 18 | ■ Examining Image Quality Further | 23 |
| Selecting the colour mode..... | 18 | Sharpness (Advanced) adjustment | 23 |
| Selecting the aspect | 18 | Auto Iris (automatic aperture) setting | 23 |
| ■ Advanced Colour Adjustments | 20 | ■ Viewing Images at a Preset Image Quality (Memory Function) | 24 |
| Skin tone adjustment..... | 20 | Saving image quality adjustments (Save Memory) | 24 |
| Absolute colour temperature adjustment.... | 20 | Retrieving image quality adjustments (Load Memory) | 24 |
| Gamma adjustment | 20 | | |
| RGB adjustment (Offset, Gain) | 22 | | |
| Hue and saturation adjustment | 22 | | |

Configuration Menu

| | | | |
|---|----|------------------------------------|----|
| ■ Configuration Menu Functions | 26 | "Settings" menu | 31 |
| List of configuration menus | 26 | "Memory" menu | 33 |
| "Picture" menu..... | 28 | "Reset" menu..... | 34 |
| "Image" menu | 29 | Using the configuration menus..... | 34 |

Troubleshooting

| | | | |
|---|-----------|--|----|
| ■ Problem Solving | 35 | When the indicators provide no help..... | 36 |
| Reading the indicators | 35 | •Problems relating to images..... | 37 |
| •  When the (warning) indicator is lit or flashing | 35 | •Problems when projection starts | 41 |
| •  When the (operation) indicator is lit or flashing | 36 | •Problems with the remote control..... | 41 |

Appendix

| | | | |
|--|-----------|---|-----------|
| ■ Maintenance | 42 | ■ Optional Accessories / Consumables | 46 |
| Cleaning | 42 | ■ List of Supported Monitor Displays | 47 |
| •Cleaning the air filter | 42 | •Component Video | 47 |
| •Cleaning the projector case | 42 | •Composite Video/S-Video | 47 |
| •Cleaning the lens | 42 | •Images from Computer | 48 |
| Consumable replacement periods | 43 | ■ Specifications | 49 |
| •Air filter replacement period | 43 | ■ Glossary | 52 |
| •Lamp replacement period | 43 | ■ Index | 54 |
| Replacing consumables | 44 | | |
| •Replacing the air filter | 44 | | |
| •Replacing the lamp | 44 | | |
| •Resetting the lamp operating time | 44 | | |

Features of the Projector

▶ Image appearance can be selected to match the projection environment (Color Mode)

The optimum images for the location can be projected simply by selecting the desired colour mode from the following seven preset modes.

If "Natural", "Theatre", "Theatre Black 1", "Theatre Black 2" or "sRGB" is selected, the Epson Cinema Filter effect is applied automatically to increase the contrast and to make skin tones appear with more natural tints. ↪ p.18

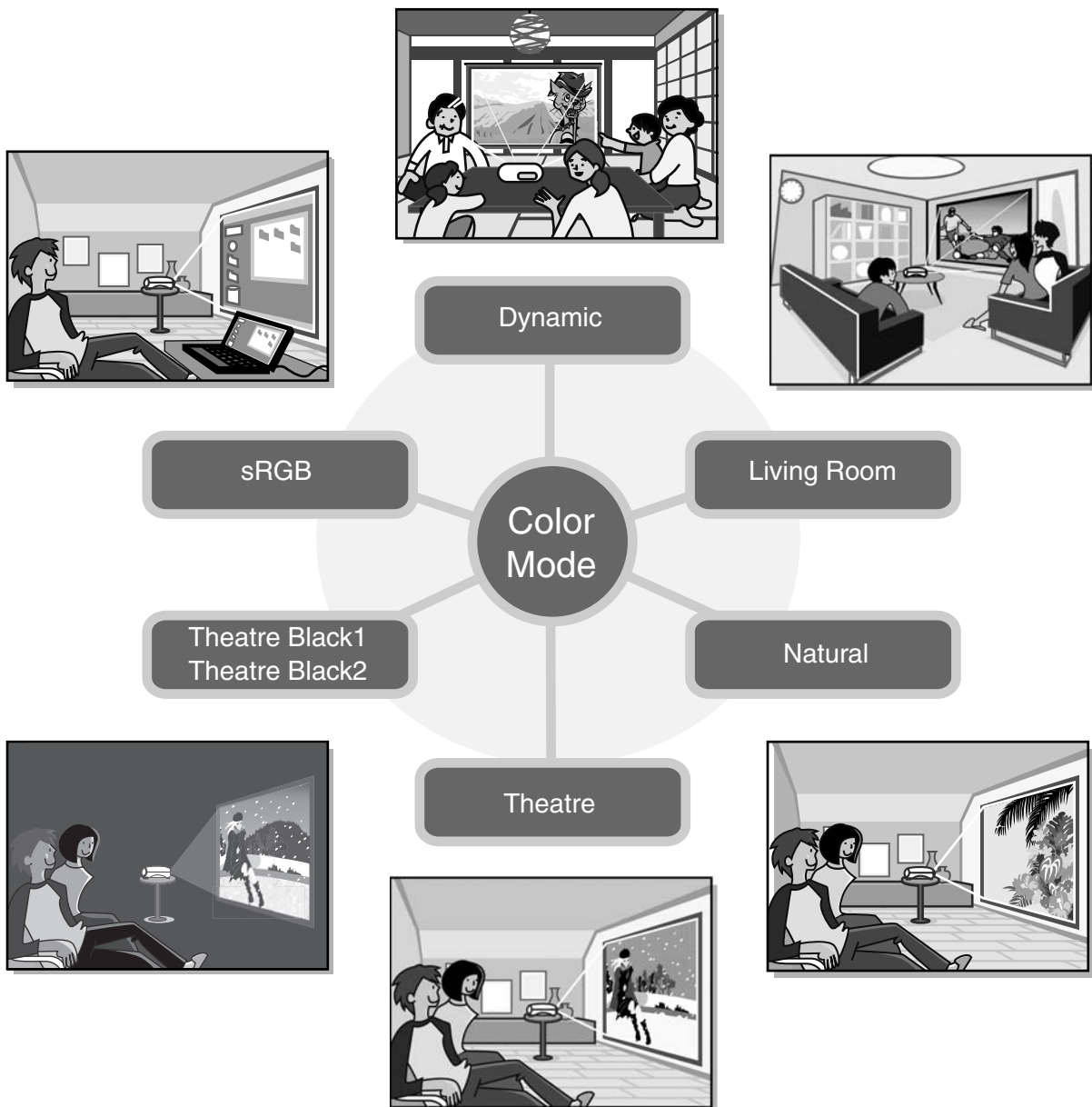

▶ Sophisticated colour adjustment

In addition to the "Color Mode", the absolute colour temperature and skin tones can be adjusted by simple procedures to render the picture even more to your own liking. Further, you can adjust gamma, the offset and gain for RGB colours, and the hue and saturation of RGB/CMY colours, to create colours that match the image.

↪ p.20

▶ Equipped with a wide-angle lens shift function

The lens shift function allows the position of the projected images to be adjusted vertically and horizontally without distorting the images. This can allow the projector to be set up with greater freedom, even if it is suspended from a ceiling or at an angle to the screen. 📖 p.16

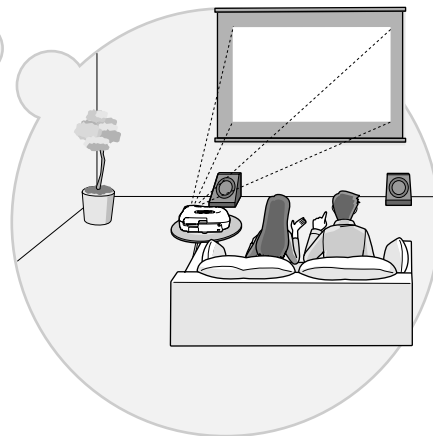
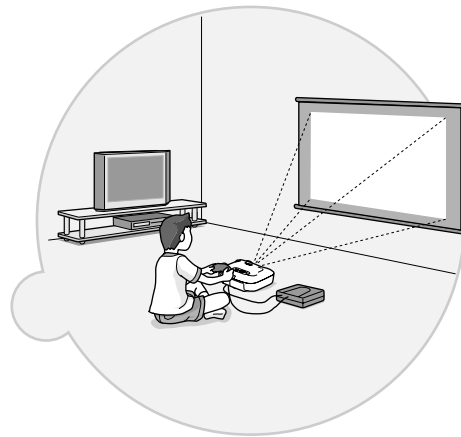
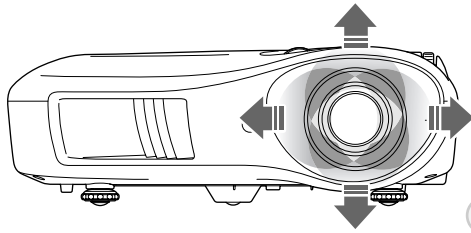

▶ Equipped with 2.1x short throw zoom lens

For zoom adjustment, 2.1x short throw zoom lens is provided. Images can be projected onto an 100" screen (16:9 screen only) even at a distance of approximately 3 m (10 ft.). 📖 p.10

▶ Advanced image quality adjustment functions

Advanced image quality adjustment functions such as "Auto Iris" and "Sharpness (Advanced)" can be used to enjoy even sharper images. With the Auto Iris function turned on, the amount of light can be automatically adjusted to match the images being projected, to create images with depth and perspective. The Sharpness function is used to adjust not only the entire image, but also to emphasize specific regions, such as hair and clothing.

📖 p.23

▶ A variety of image setting functions

Some of the other many functions that are available are as follows.

- EPSON Super White is used to prevent overexposure that can result in images that are too bright. 📖 p.30
- A progressive▶ conversion that lets you obtain ideal results both for images with large amounts of movement and for still images. 📖 p.30
- An aspect▶ function that allows images to be viewed in wide-screen format. 📖 p.18
- Memory functions that allow adjustment results to be stored and later retrieved easily using the remote control. 📖 p.24
- Lock settings that can be used to lock the projector's control panel after adjustments have been made so that they cannot be changed by mistake, or to prevent children from accidentally turning on the power and looking into the lens. 📖 p.31

Part Names and Functions

Front / Top

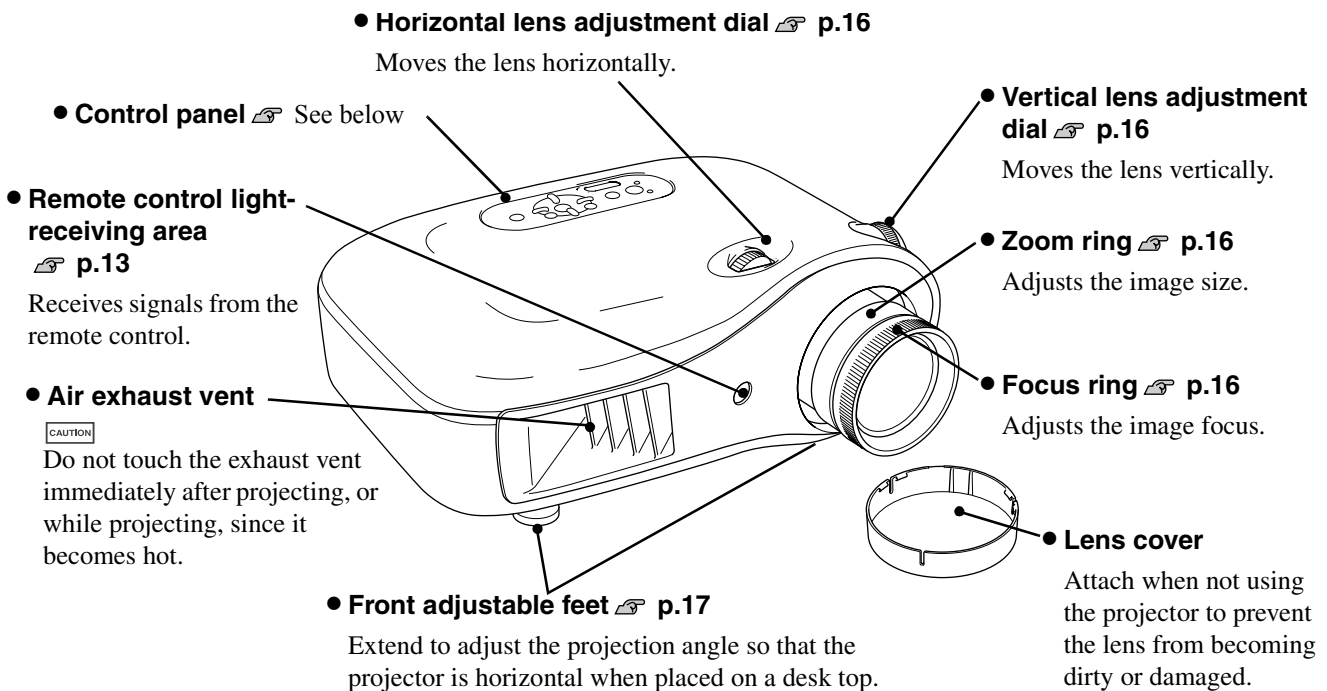

Control panel

Buttons with no explanation function in the same way as the corresponding buttons on the remote control. Refer to "Remote control" for further details on these buttons.

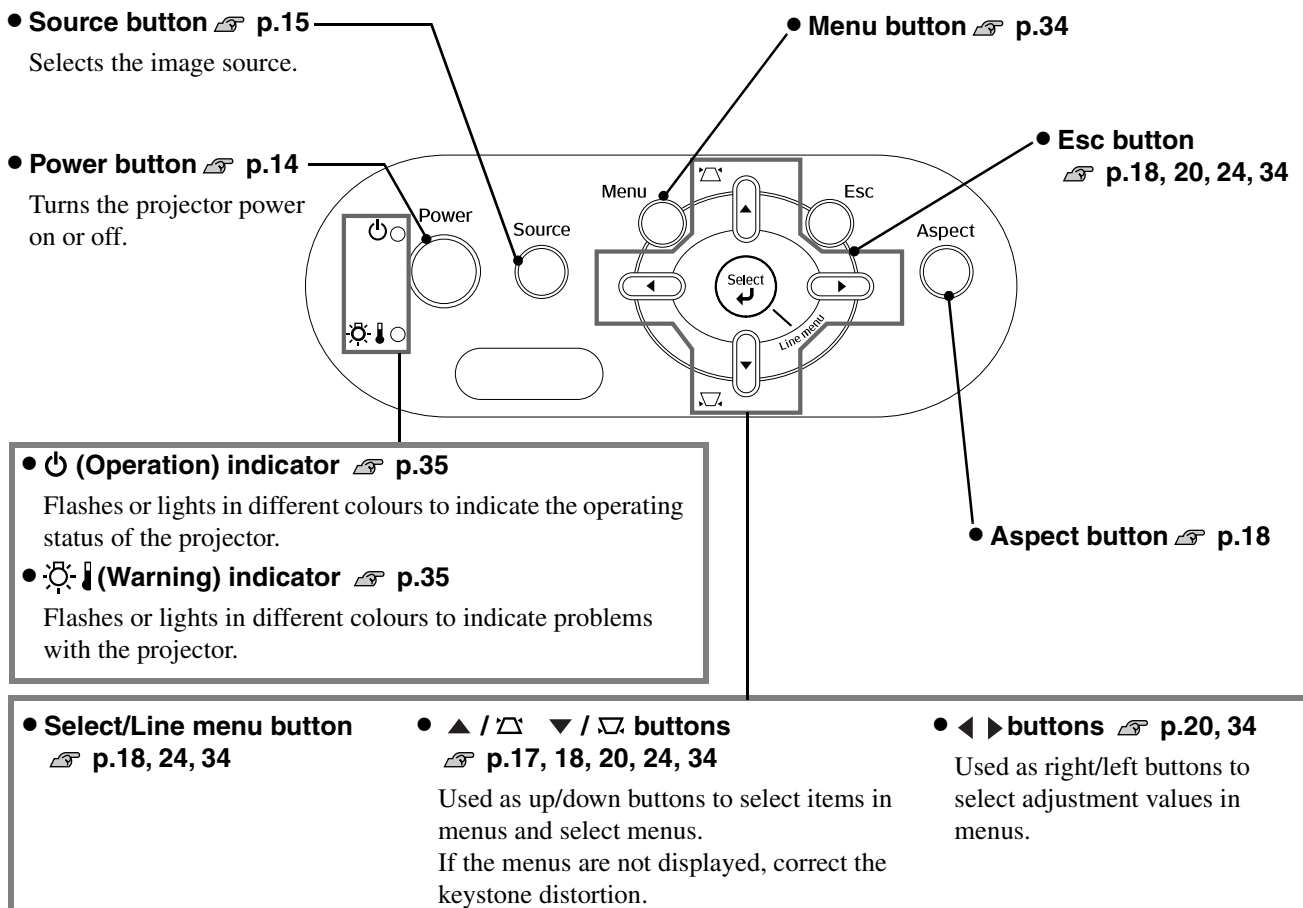

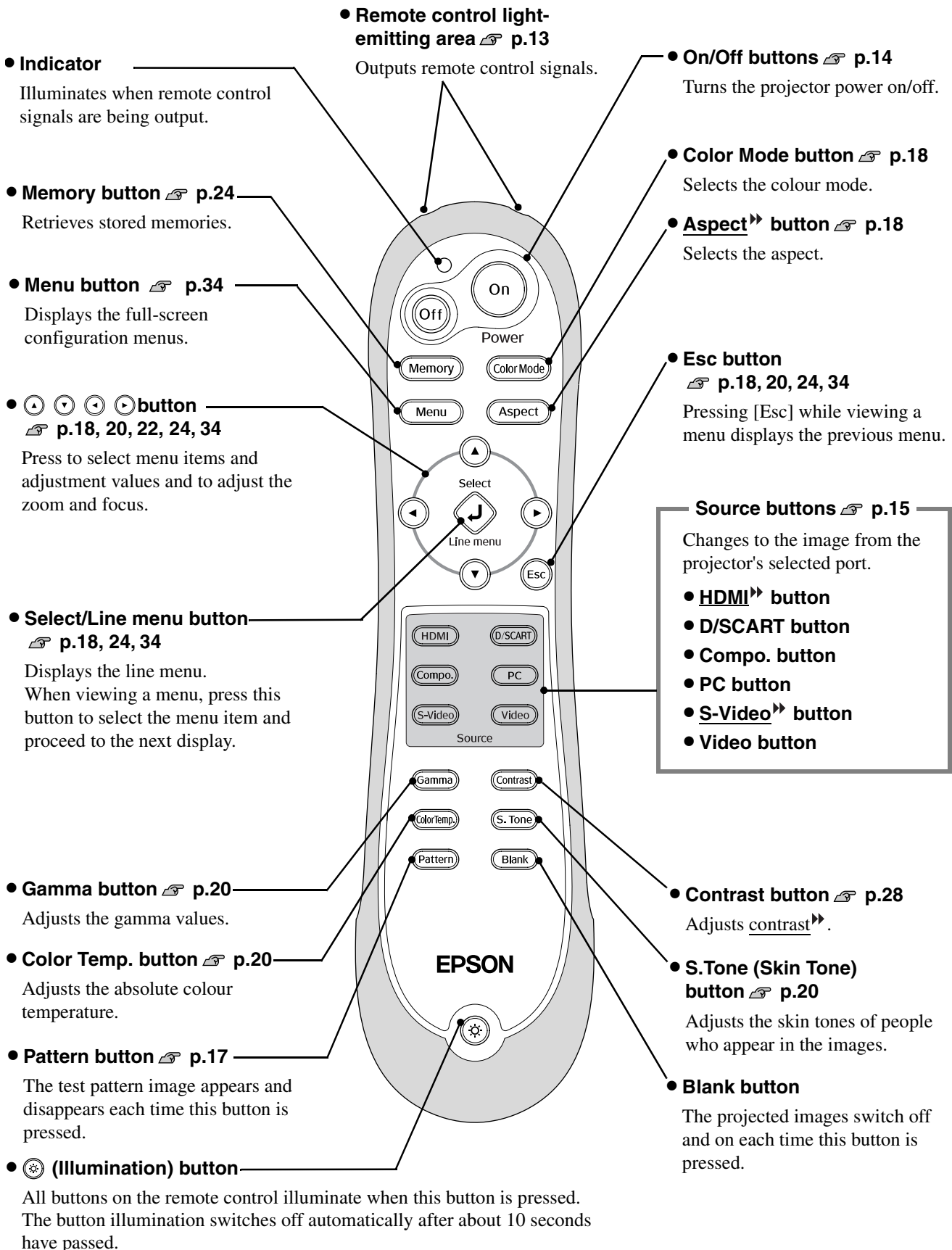

Remote control



Rear

- **[SCART] input port**  p.12

Connects to the SCART ports of other video equipment using the D SCART adaptor that is packed with the projector.
- **[Component] input port**  p.12

Connects to the component video (YCbCr or YPbPr) ports of other video equipment.
- **[PC] input port**  p.12



Connects to the RGB port of a computer.
- **[HDMI] input port**  p.12

Connects to video equipment or a computer that is HDMI-compatible.
- **[Trigger out] port**

When the projector power is turned on, a 12 V DC signal is output from this port. When the projector's power is turned off or a problem with operation occurs, the output becomes 0 V to send the projector's power ON/OFF status to an external device.
- **Remote control light-receiving area**  p.13

Receives signals from the remote control.
- **[Video] input port**  p.12

Connects to general video ports of other video equipment.
- **[S-Video] input port**  p.12

Inputs an S-Video signal to the projector from other video equipment.
- **Main power switch**  p.14
- **Power inlet**  p.14

Connects the power cable.
- **[RS-232C] port**

Connects the projector to a computer using an RS-232C cable. This port is for control use and should not be used by the customer.
- **Security lock**  p.53

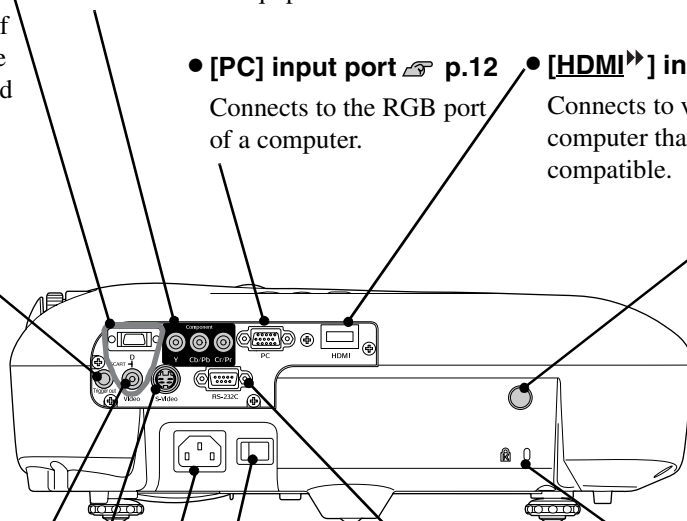

Base

- **Suspension bracket fixing points (4 points)**  p.46

Install the optional ceiling mount here when suspending the projector from a ceiling.

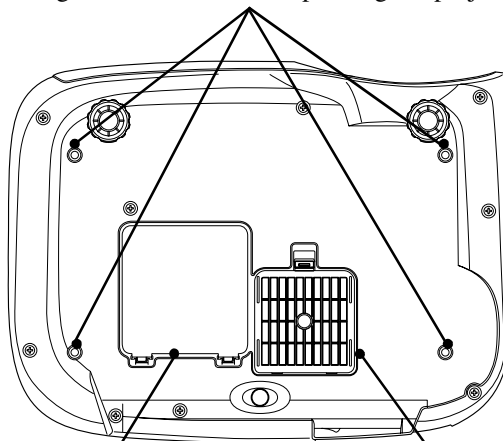

- **Lamp cover**  p.44

Open this cover when replacing the lamp inside.
- **Air filter (air intake vent)**  p.42, 44

Prevents dust and other foreign particles from being drawn into the projector. It should be cleaned periodically.

Appearance

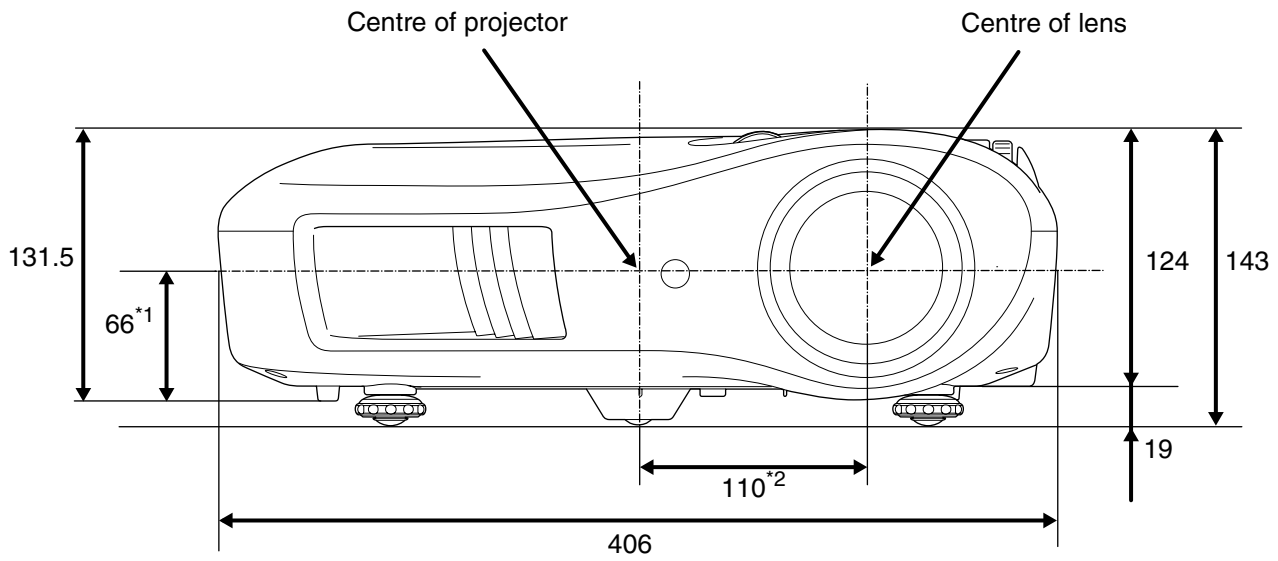

- *1 Distance from centre of lens to suspension bracket fixing point (Lens shift amount: Max. 8.8 mm vertically)
- *2 Distance from centre of lens to centre of projector (Lens shift amount: Max. 7.7 mm horizontally)

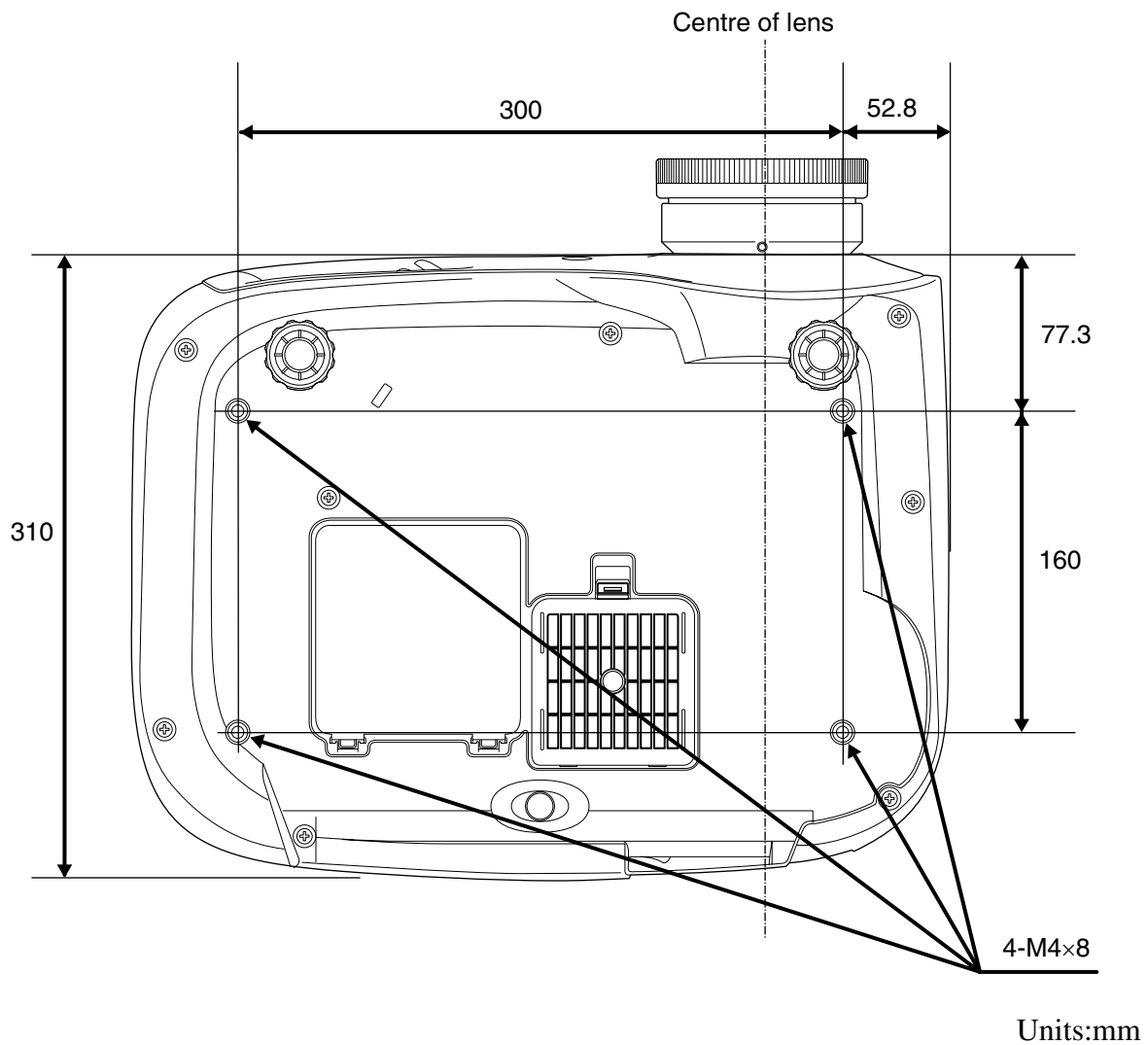

Adjusting the projection size

The size of the projected image is basically determined by the distance from the projector's lens to the screen.

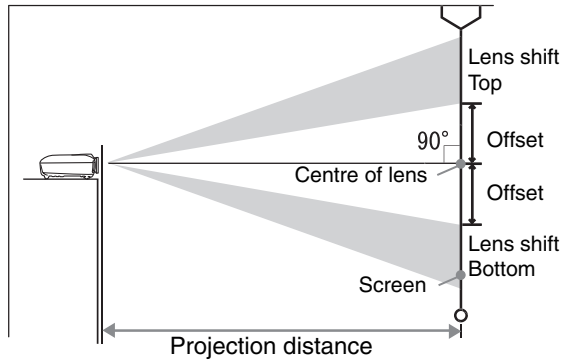

The height from the centre of the lens to the bottom of the screen will vary depending on the lens shift setting.

While referring to the table below, position the projector so that the images are projected onto the screen at the optimum size.

The values should be used as a guide for setting up the projector.

| Units: cm (in) | | Units: cm (ft.) | | Units: cm (in.) | Units: cm (in) | | Units: cm (ft.) | | Units: cm (in.) |
|------------------|-------------------|----------------------|---|-----------------|-----------------|-------------------|-----------------------|---|-----------------|
| 16:9 screen size | | Projection distance | | | 4:3 screen size | | Projection distance | | |
| | | Shortest (Wide) | - | Longest (Tele) | | | Shortest (Wide) | - | Longest (Tele) |
| 30" | 66x37 (26x15) | 93-200 (3.0-6.6) | | 20 (7.7) | 30" | 61x46 (24x18) | 113-245 (3.7-8.0) | | 24 (9.4) |
| 40" | 89x50 (35x20) | 125-268 (4.1-8.8) | | 26 (10.3) | 40" | 81x61 (32x24) | 153-328 (5.0-10.8) | | 32 (12.6) |
| 60" | 130x75 (51x28) | 189-404 (6.2-13.3) | | 39 (15.4) | 60" | 120x90 (47x35) | 231-494 (7.6-16.2) | | 48 (18.8) |
| 80" | 180x100 (71x39) | 253-540 (8.3-17.7) | | 52 (20.5) | 80" | 160x120 (63x47) | 310-661 (10.2-21.7) | | 64 (25.1) |
| 100" | 220x120 (87x47) | 318-676 (10.4-22.2) | | 65 (25.6) | 100" | 200x150 (79x59) | 389-827 (12.8-27.1) | | 80 (31.4) |
| 120" | 270x150 (106x59) | 382-812 (12.5-26.6) | | 78 (30.8) | 120" | 240x180 (94x71) | 468-993 (15.3-32.6) | | 96 (37.7) |
| 150" | 330x190 (130x75) | 478-1016 (15.7-33.3) | | 98 (38.5) | 150" | 300x230 (118x91) | 586-1243 (19.2-40.8) | | 120 (47.1) |
| 200" | 440x250 (173x98) | 639-1355 (21.0-44.5) | | 130 (51.3) | 200" | 410x300 (161x118) | 782-1659 (25.7-54.4) | | 159 (62.8) |
| 300" | 660x370 (260x146) | 961-2035 (31.5-66.8) | | 195 (76.9) | 300" | 610x460 (240x181) | 1176-2490 (38.6-81.7) | | 239 (94.1) |

Lens shift adjustment

The lens shift dials can be used to position the image and is especially useful when using the projector in the following locations.  p.16

- Hanging from the ceiling
- A screen in a high location
- Projector situated to the side so that the screen can be viewed sitting right in front of it
- Projector situated on a shelf, etc.

When positioning an image using the lens shift dial, hardly any deterioration of the image occurs because the lens shift correction is adjusted optically. However, for optimal image quality the lens shift function should not be used.

Projection methods

CAUTION

- Avoid setting the projector up in a place which is very dusty or humid, or where there will be cigarette or other smoke, especially oily smoke.
- Clean the air filter at least once every 3 months.
Clean the air filter more frequently if using the projector in a dusty environment.
- A special method of installation is required when suspending the projector from the ceiling (ceiling mount). If it is not installed correctly, it could fall causing an accident and injury.
- If you use adhesives on the ceiling mount to prevent the screws from loosening, or if you use things such as lubricants or oils on the projector, the projector case may crack causing it to fall from its ceiling mount. This could cause serious injury to anyone under the ceiling mount and could damage the projector.
When installing or adjusting the ceiling mount, do not use adhesives to prevent the screws from loosening and do not use oils or lubricants and so on.
- Do not use the projector on its side. This may cause malfunctions to occur.

■ When projecting from directly in front

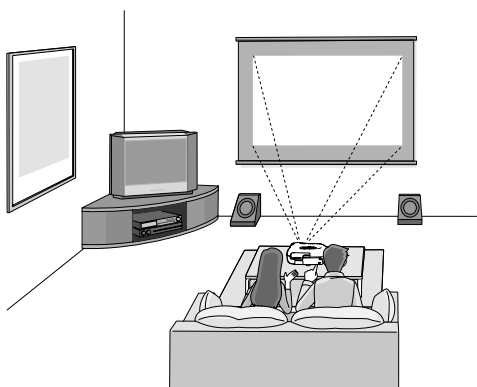

■ When projecting from the side of the screen

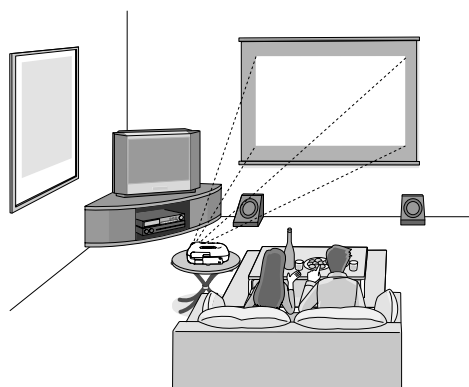

■ When projecting from a ceiling

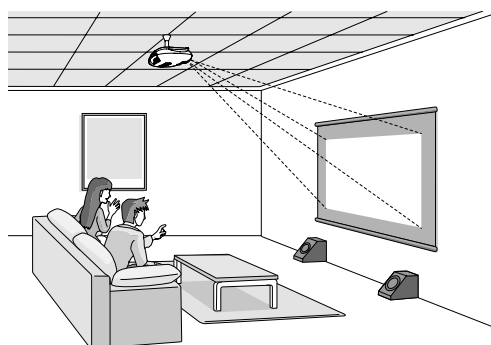

* Even if projection will be from the screen side, set up the screen and projector so that they are parallel.

* When suspending the projector from a ceiling, change the configuration menu settings. p.33

Configuration menu

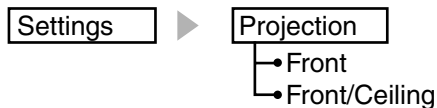

Connecting Image Sources

CAUTION

- Turn the power off for both the projector and the signal source before connecting them. If the power for either device is on at the time of connection, damage may result.
- Check the shapes of the cable connectors and the device ports before making the connections. If you try to force a connector to fit a device port with a different shape or number of terminals, a malfunction or damage to the connector or port may result.

Video equipment (VHS VCR, DVD player, game console, etc.)



*Port names may vary depending on the equipment being connected.

Computer

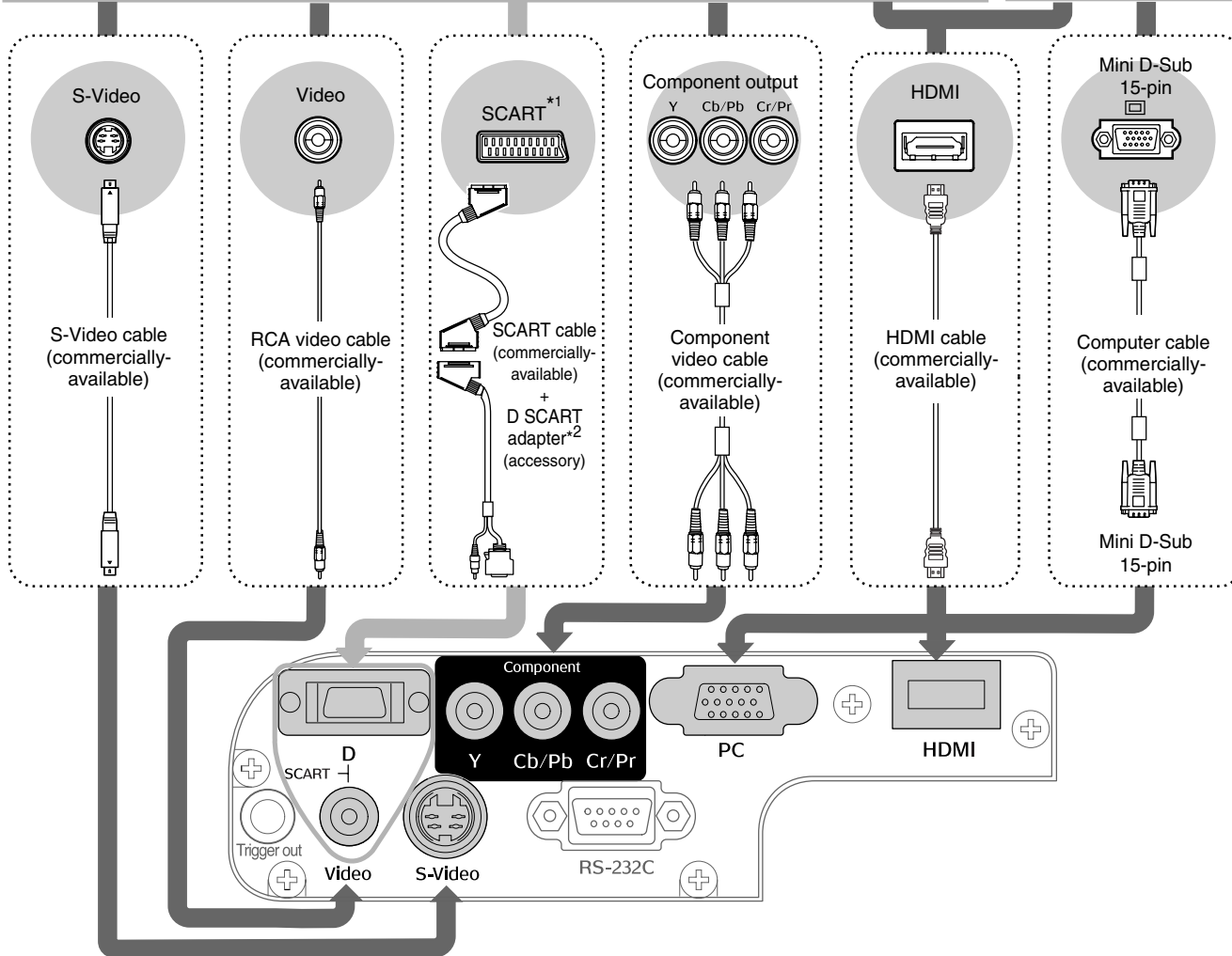

*1 If a DVD has been connected using a D SCART adapter, change the "D/SCART" setting in the "Input Signal" to "SCART". "Selecting the image source" p.15

*2 Some regions may not have the D SCART adapter included as an accessory.



TIP

- Some signal sources may have specially-shaped ports. In such cases, use the accessory or optional cables that are supplied with the signal source to make the connections.
- The cable that should be used to connect video equipment to the projector will depend on the type of video signal that the equipment outputs. Some kinds of video equipment output several different types of video signal. The image quality ranking of the video signal types is generally held to be as follows, in descending order of quality: Digital component video [HDMI] Analog component video [D] [Component] S-Video [S-Video] Composite video [Video]
You should refer to the documentation provided with the video equipment being used to check what types of video signal formats the equipment can output. The composite video format is sometimes simply called "video output".

Preparing the Remote Control

Inserting batteries into the remote control

The remote control is not supplied with batteries already inserted. Insert the accessory batteries before using the remote control.

1 Remove the battery cover.

While pressing the knob, lift up.

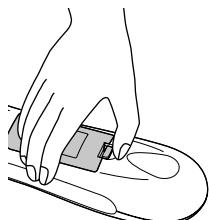

3 Install the battery cover.

- ① Insert the tab.
- ② Press down until the battery cover clicks into place.

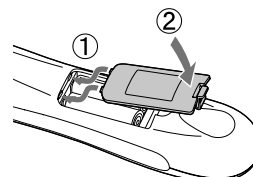

2 Insert the batteries.

CAUTION Check the (+) and (-) indications inside the battery compartment and insert the batteries so that they face correctly.

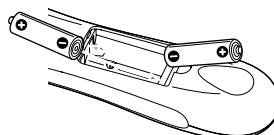

TIP

If delays in the responsiveness of the remote control occur or if it does not operate after it has been used for some time, it probably means that the batteries are becoming flat. If this happens, replace the batteries with two new batteries. Use two new AA batteries as replacement batteries.

Using the remote control

■ Operating range (horizontal)

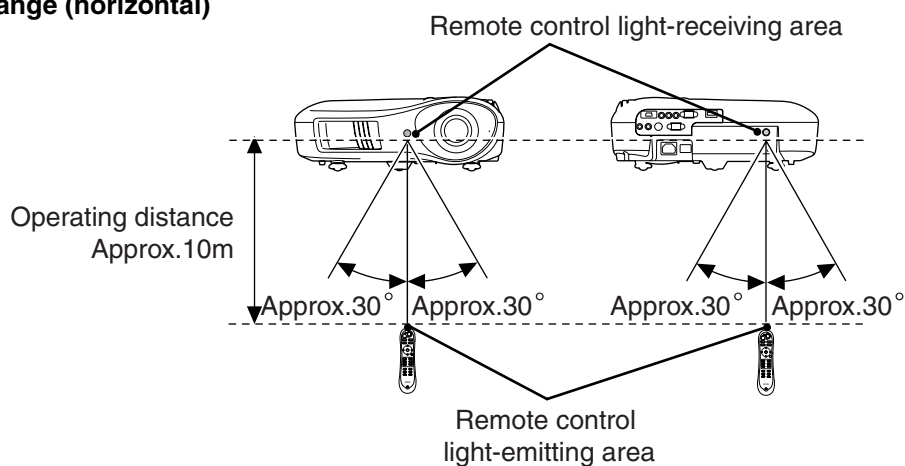

■ Operating range (vertical)

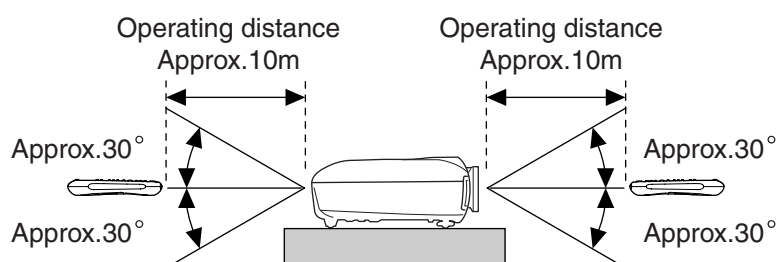

Projecting Images

Turning the power on and projecting images

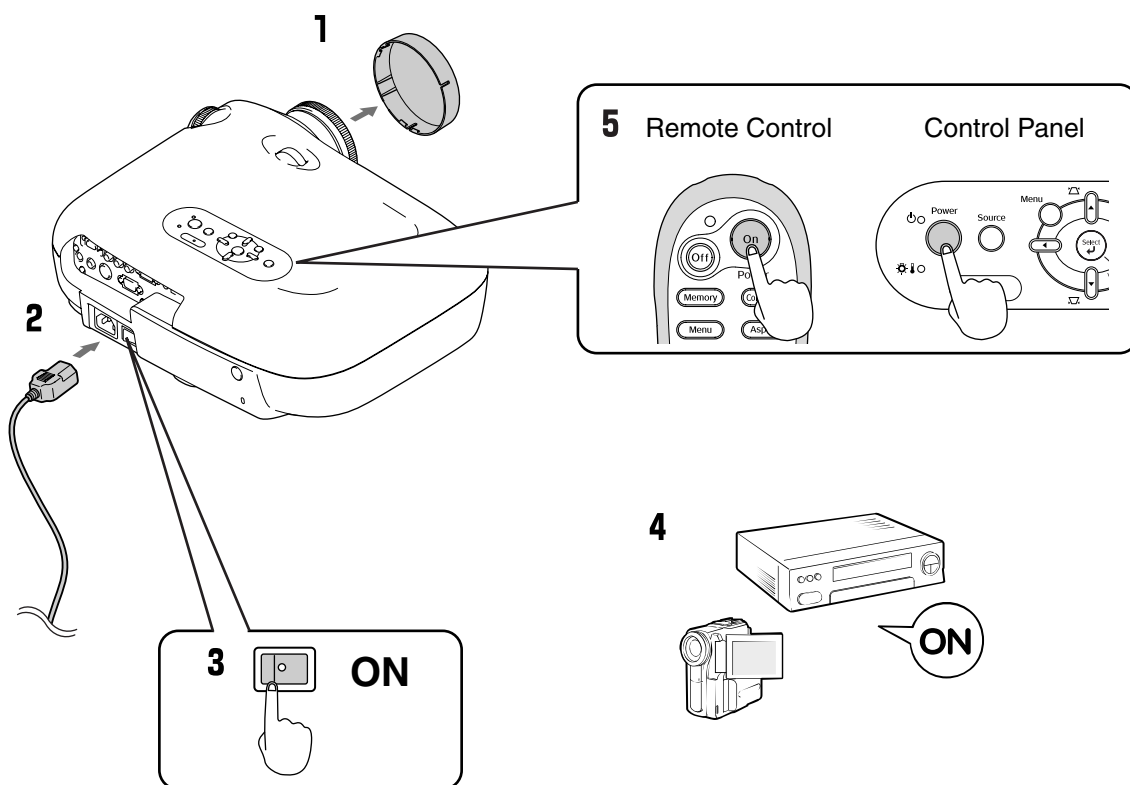

If there is a problem with projection even though the projector is set up and connected correctly, refer to [p.15, 35](#).



- If you set the "Direct Power On" to "On", the power of the unit will turn ON when the main power switch is turned ON, without having to press the power button of the remote control or the projector's control panel.
- The projector is equipped with a "Child Lock" function that prevents young children from accidentally turning the power on and looking into the lens, and also an "Operation Lock" function that prevents mis-operations. [p.31](#)
- When using above an altitude of about 1500 m, make sure you set the "High Altitude Mode" to "On". [p.32](#)
- This projector is equipped with an automatic adjustment function that automatically optimizes it when a computer input signal is switched.
- If a laptop computer or a computer with a LCD screen has been connected to the projector, you may need to use keyboard or function settings to change the output destination. While holding down the **Fn** key, press **F0** (the key with a symbol such as / on it). After the selection is made, projection will soon start.
[Computer documentation](#)

| Example of output selection | |
|-----------------------------|---|
| NEC | |
| Panasonic | Fn + F9 |
| SOTEC | |
| HP | Fn + F4 |
| Toshiba | Fn + F5 |
| IBM | |
| SONY | Fn + F7 |
| DELL | Fn + F8 |
| Fujitsu | Fn + F10 |
| Macintosh | Set mirror setting or display detection. Depending on OS, you can change the output selection by pressing F7 . |

When the expected images are not projected

If more than one signal source has been connected, or if no images are projected, use the remote control or the projector's control panel buttons to select the signal source. For video devices, press the [Play] button on the video equipment first, then select the signal source.

Using the remote control

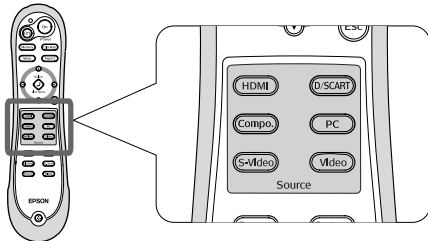

Press the button that has the name of the port on it that the desired signal source is connected to.

Using the control panel

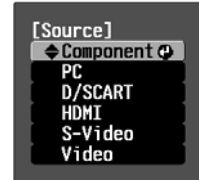
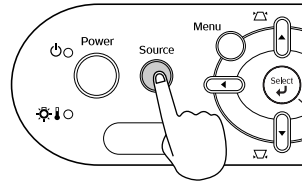

When you press **Source**, the menu is displayed. Use **Up** or **Down** to select the signal source. Press **Select** to accept.

When projecting an image from the [Component] port

The default setting is set to "Auto" to select appropriate signals automatically. However, if the colours appear unnatural, switch the image signal to match the equipment.

Using the remote control

While projecting an image from equipment connected to the [Component] port, press **Compo** to display the menu.

Using the control panel

While projecting an image from equipment connected to the [Component] port, select "Component" and confirm to display the menu.



Use **Up**, **Down**, or **Left/Right** to select the correct signal to match the equipment. Press **Select** or **Select** to accept.

Turning the power off

- 1 Turn the power off for the signal sources that are connected to the projector.
- 2 Press **Off** on the remote control or **Power** on the projector's control panel. If you press **Power** on the projector's control panel, the following message will be displayed. Press **Power** again to continue.
- 3 When the projector has cooled down (takes about 30 seconds), turn off the main power switch. Simply pressing **Off** or **Power** does not stop electricity consumption.
- 4 Attach the lens cover.

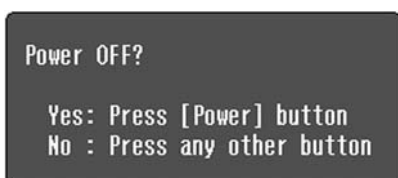

Adjusting the Projection Screen

■ Focus adjustment

Turn the focus ring to adjust the focus.

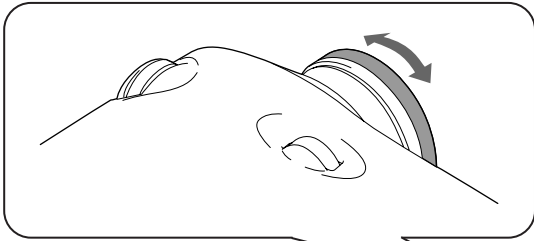

■ Fine adjustments to image size (Zoom adjustment)

Turn the zoom ring to adjust the size of the projected image.

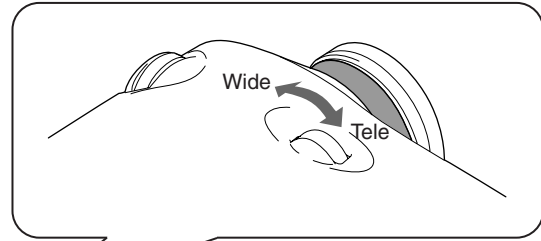

■ Projection image position adjustment (Lens shift)

Use the two lens shift dials to adjust the image position.

If you cannot position the projector straight in front of the screen, use the lens shift dial so that the image is centered on the screen. When you turn the lens shift dial and hear a click, the lens position is almost centred.

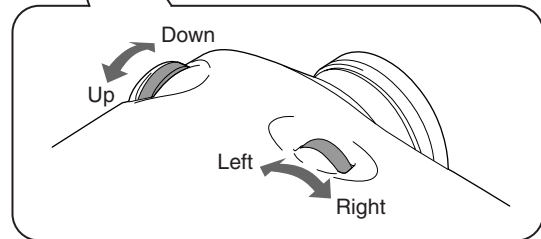

You can shift the image by 102% in the vertical direction, and 50% in the horizontal direction. However, you cannot shift the image to these vertical and horizontal limits simultaneously.

Ex) When the image is shifted horizontally by the full amount, it cannot be shifted vertically. And when the image is shifted vertically by the full amount, it cannot be shifted horizontally by more than 10% of its width.

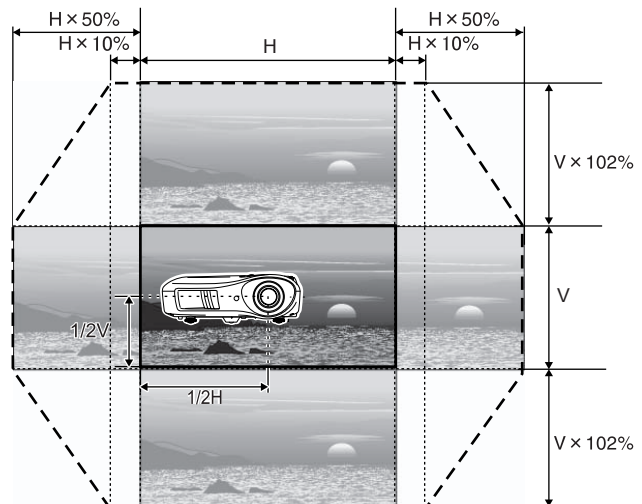

Standard (centre position for projection position) (centre position for lens shift)

Range that the picture can be shifted from the standard projection position

CAUTION

When transporting the projector, make sure to turn the lens position down by the full amount. Otherwise the lens shift function may be damaged.

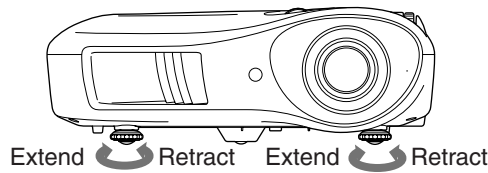

Correcting projector tilt

If the projected images are tilted horizontally, use the front adjustable feet to adjust the projector so that it is horizontal.



Correcting keystone distortion (Keystone)

When you wish to adjust the projection above or below the range of lens shift adjustment set the projector at an angle.



When the projector is angled, the projected image may distort into a trapezoid. In such cases, press   on the control panel to adjust the images.

However, the image quality will decrease compared to if the lens shift function is used. When the lens is shifted to the left or right, complete keystone correction is not possible. When making keystone corrections set the lens at the centre left to right.

Keystone distortion can be corrected within a maximum vertical angle of approximately 15°.



TIP

- You can also make adjustments from the configuration menu.  p.31
- To reset the correction value, press and hold down  with  pressed down for at least 1 second on the control panel.

Displaying a test pattern

You can project a test pattern at times such as when setting up the projector in order to correct keystone correction and to make line menu adjustments.

You can also adjust the zoom and focus using the test pattern.

If  on the remote control is pressed, the test pattern appears.

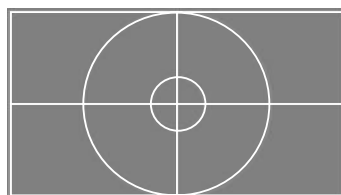

To stop displaying the test pattern, press  again.

Basic Image Quality Adjustments

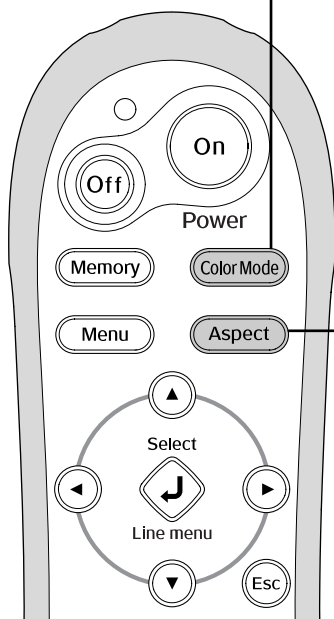

Selecting the colour mode



[Esc]:Return [↕]:Select [Select]:Set [Menu]:Exit

Press **Color Mode** and select the colour mode from the menu.

Setting is also possible using the configuration menu.

Press **▲** or **▼** on the remote control or **↑** or **↓** on the projector's control panel to select an item.

Press **Select** or **Enter** to confirm the selection.

* If you press **Esc**, the menu disappears.

Selecting the aspect



[Esc]:Return [↕]:Select [Select]:Set [Menu]:Exit

Press **Aspect** and select the aspect mode from the menu.

When projecting using **Auto**

- For 4:3 input signals → Normal
- For input images recorded in squeeze mode → Squeeze
- For letterbox input signals → Zoom

*1 Not usable during computer input. Not compatible with certain component video signals.

*2 If Auto is not suitable, the setting will become Normal.







TIP

If you project an image that is compressed, enlarged or separated using the aspect function in public places such as a store or hotel for the purposes of profit-making or public display, it may result in infringing on the author's right that is protected by copyright law.

- Dynamic** : Ideal for using in bright rooms.
- Living Room** : Ideal for using in rooms in which the curtains are closed.
- Natural** : Ideal for using in dark rooms. It is recommended that you start in this mode when making colour adjustments.
- Theatre** : Ideal for using in dark rooms.
- Theatre Black 1** : Suitable for use in a completely darkened room.
- Theatre Black 2** :
 - 1: A clear tone of colour one might see in professional monitors used when creating DVD software.
 - 2: A deep warm tone of colour that gives you the feeling of enjoying a movie at the theatre.
- sRGB** : If the connected signal source has an **sRGB** mode, set both the projector and the connected signal source to sRGB. (Ideal for viewing computer images.)

When you select the colour mode indicated with ■, the Epson Cinema Filter will be applied automatically to increase the contrast and makes skin tones more natural.

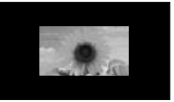
| | | | | |
|-------------------------|---|---|---|--|
| Input signal | <ul style="list-style-type: none"> ● Normal TV broadcasts ● Images with standard aspect ratio (4:3) ● Computer images | Images recorded by a video camera or DVD software in squeeze mode | Letterbox images | <ul style="list-style-type: none"> ● Normal TV broadcasts ● Images with standard aspect ratio (4:3) |
| Recommended aspect mode | Normal | Squeeze | Zoom | Wide |
| Result |  Black bands will appear at the left and right of the images. |  Input signals will be projected at the same width as the projector's panel resolution. |  Input signals will be projected at the same height as the projector's panel resolution. |  Input signals will be projected at the same height as the projector's panel resolution. At this time, the image enlargement ratio will be smaller near the middle of the images but become larger towards the left and right edges of the images. |
| Remarks | <p>When HDTV images are projected, the images appear in 16:9 size.</p> <p>When the image resolution is 1280 x 720 or less and "Through" or "Squeeze Through" is selected, the image will be projected clearer since the resolution is retained.</p> <div style="display: flex; justify-content: space-around; align-items: center;"> <div style="text-align: center;"> <p>Through</p>  </div> <div style="text-align: center;"> <p>Squeeze Through</p>  </div> </div> <p>To project images so that they fill the whole of the screen, use the zoom adjustment or adjust the distance between projector and screen.</p> | <p>When 4:3 images are projected, the images will be elongated horizontally.</p> | <ul style="list-style-type: none"> ● When 4:3 images are projected, the top and bottom of the images will be truncated. ● When images with subtitles are projected and the subtitles are truncated, use the "Zoom Caption" menu command to adjust. p.29 | <p>This is useful for when 4:3 images are projected onto a wide screen. Because there is almost no distortion due to enlargement in the middle of the images, the images appear close to what they would be at their original size. And because both ends of the images are enlarged, movement at the edges of the images appears faster and gives an impression of greater speed, making it ideal for viewing sporting events.</p> <p>*"Wide" cannot be selected if keystone correction has been carried out.</p> |

Advanced Colour Adjustments

If you would like to create your own images with settings adjusted the way you want them, you can adjust "Skin Tone", "Abs. Color Temp.", "RGB/RGBCMY" and/or "Gamma" in the "Color Adjustment" sub-menu of the "Picture" menu. (When "sRGB" is not selected in Color Mode.)

The adjustment values can be stored in the memory so that you can retrieve them and apply them to the projected images at any time. (p.24)

"Skin Tone", "Abs.Color Temp." and "Gamma" are adjusted using the respective remote control buttons.

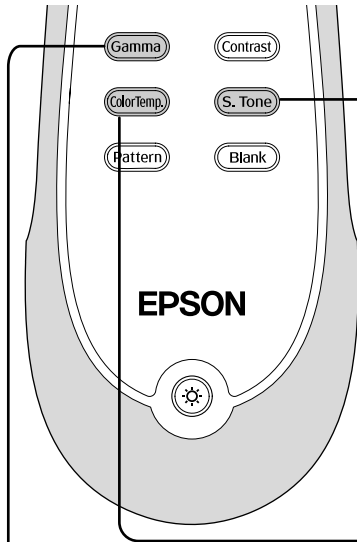

Skin tone adjustment

[Skin Tone]
Skin Tone 4 [Left Arrow] [Right Arrow]
[Left Arrow]:Adjust

Absolute colour temperature adjustment

[Abs. Color Temp.]
Abs. Color Temp. 8000K [Left Arrow] [Right Arrow]
[Left Arrow]:Adjust

Press on the remote control or on the projector's control panel to make the adjustment.
* If you press , the menu disappears.

Gamma adjustment

[Gamma]
[2.0]
[2.1]
[2.2] [Left Arrow]
[2.3]
[2.4]
[Customized]
[Reset]
[Left Arrow]:Select [Select]:Set [Gamma]:Exit

Differences between equipment may result in a slight variation in the colouring when images are projected, and you may want to adjust this. (Projection will stop temporarily during such adjustment.) There are two methods of doing so. One is to select one of the gamma correction values [2.0], [2.1], [2.2], [2.3], [2.4]. The other is customized adjustment, which is done with reference to the projected image or a gamma graph. The gamma graph's horizontal axis represents the input signal level and its vertical axis the output signal level.

■ Adjusting from the gamma correction values

From among the gamma correction values [2.0], [2.1], [2.2], [2.3], [2.4], select one that suits the connected equipment, or one of your own liking, using or , and press or to confirm the selection.

Observe the gamma graph to check the result of the adjustment.

Lower values will increase the contrast of the dark portions but will tend to blur the bright portions. This is indicated by bulging in the upper portion in the gamma graph.

Higher values will darken the bright portions. This is indicated by bulging in the lower portion in the gamma graph.

This can be used to adjust the skin tones for images of people.

The Epson Cinema Filter effect that is automatically applied to images when a "Color Mode" setting is made creates natural-looking skin tones. If you would like to further enhance skin tones, use this "Skin Tone" setting to make the adjustment.

If set to the + side, the colours become greenish, and if set to the – side, the colours become reddish.

You can adjust the overall tint of images.

If you select a higher value, images appear bluish, and if you select a lower value, images appear reddish. The absolute colour temperature can be set to one of 12 settings within the range of 5000K to 10000K.

■ Customized ("Adjust it from the image")

Use or to select first "Customized", then "Adjust it from the image". Press or to confirm the selection each time. A gamma icon will appear in the projected image. (Keystone correction will be temporarily cancelled while the gamma icon is displayed.)



Use or to move the gamma icon to the place where you want to adjust the brightness, and press or to confirm the selection. The place selected and the regions of the same brightness will flash, and a gamma graph will appear. Press or again to reconfirm. A screen for adjusting the tone will appear.

Use or to make the adjustment, and press or to confirm it. Press to go back and do it again.

■ Customized ("Adjust it from the graph")

Use or to select first "Customized", then "Adjust it from the graph". Press or to confirm the selection each time. A gamma adjustment graph will appear.

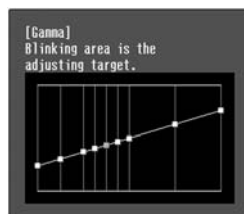

[Select]:Enter

Use or to select the point where you want to adjust the tone brightness, and press or to confirm the selection. A screen for adjusting the tone will appear.



[Esc]:Return [Left]:Adjust [Select]:Set [Gamma]:Exit

Use or to make the adjustment, and press or to confirm it.

RGB adjustment (Offset, Gain)

- 1 Press **[Menu]** and then select "Picture" - "Color Adjustment" - "RGB/RGBCMY" - "RGB" in that order and confirm the selection.

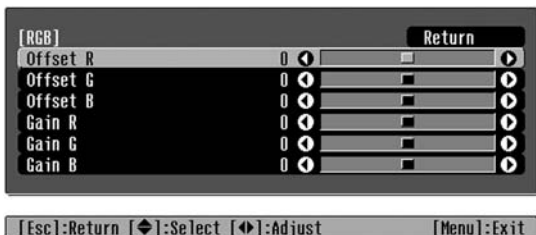

- 2 Use **[Up/Down Arrow]** or **[Left/Right Arrow]** to select a menu item, and use **[Left/Right Arrow]** or **[Up/Down Arrow]** to make adjustments.
- 3 Press **[Menu]** to exit the menu.

The image brightness can be adjusted by adjusting the individual R (red), G (green) and B (blue) components of the dark areas (offset) and bright areas (gain).

■ Offset

If you would like dark areas to appear more clearly, change the setting to the + (right) side. If you change it to the - (left) side, the whole image will become sharper, but the contrast in dark areas will become poorer.

■ Gain

If you would like bright areas to appear more clearly, change the setting to the - (left) side. If you change it to the + (right) side, bright areas will become whiter, but the contrast will become poorer.

Hue and saturation adjustment

- 1 Press **[Menu]** and then select "Picture" - "Color Adjustment" - "RGB/RGBCMY" - "RGBCMY" in that order and confirm the selection.

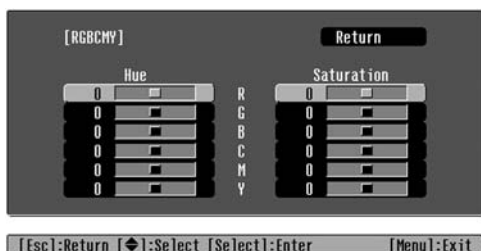

- 2 Press **[Up/Down Arrow]** or **[Left/Right Arrow]** to select a colour and press **[Select]** or **[Enter]** to confirm. Select either hue or saturation and use **[Left/Right Arrow]** or **[Up/Down Arrow]** to adjust. To adjust another colour, press **[Esc]** or select "Return".

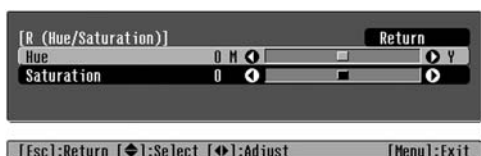

- 3 Press **[Menu]** to exit the menu.

The hue and saturation for each of the red (R), green (G), blue (B), cyan (C), magenta (M) and yellow (Y) colour components can be adjusted.

■ Hue

Adjusts the overall colouration from blues to greens to reds.

■ Saturation

Adjusts the overall vividness of the images.

Examining Image Quality Further

In addition to colour adjustments, adjustments to advanced sharpness and the amount of light from the lamp can also be made to match the image in search of the best picture.

Sharpness (Advanced) adjustment

- 1 Press **Menu**, and then select "Picture" - "Sharpness" - "Advanced".

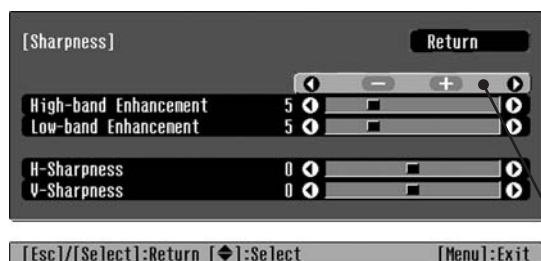

- 2 Use **Up/Down** or **Left/Right** to select a menu item, and use **Left/Right** or **Left/Right** to make adjustments.

- 3 Press **Menu** to exit the menu.

Adjust the resolution and contrast of the image.

If "High-band Enhancement" is set in the + direction, hair and the detailed areas of clothing will be emphasized.

If "Low-band Enhancement" is set in the + direction, the areas emphasized by "High-band Enhancement" will be hardly emphasized. Instead, the rough areas of the entire subject, such as contour and background, will be emphasized, resulting in a sharp image.

(You can adjust "High-band Enhancement" and "Low-band Enhancement" at the same time by using the bar on the top in the screen.)

Setting "H-Sharpness" / "V-Sharpness" to the + side will enhance the image sharpness in the horizontal / vertical direction. Setting them to the - side will give a soft image.

Auto Iris (automatic aperture) setting

- 1 Press **Menu**, and then select "Picture" - "Auto Iris".

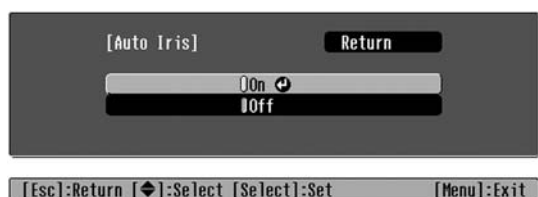

- 2 Select "On".

- 3 Press **Menu** to exit the menu.

The amount of light will be automatically adjusted to the brightness of the image, creating a picture with depth and perspective.

* An operation sound of Auto Iris function may be emitted while projecting some images. This is not a failure of the projector.

Viewing Images at a Preset Image Quality (Memory Function)

After menu commands such as "Color Adjustment" and "Advanced" have been used to adjust the projected images, the adjustment values can then be saved. In addition, the saved data can be retrieved easily, so that you can enjoy viewing images with the adjusted settings at any time.

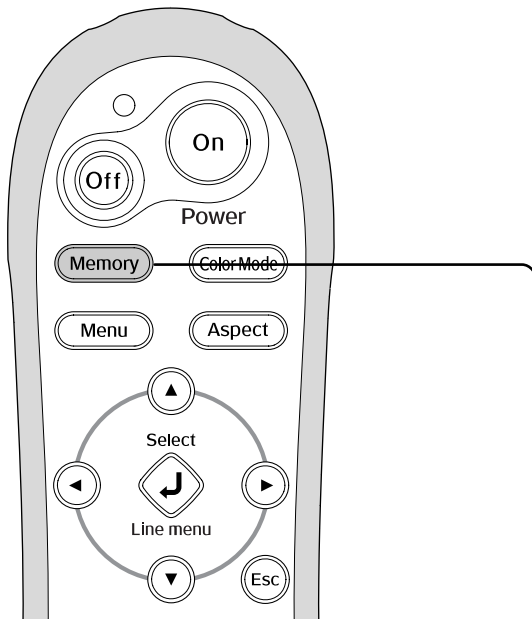

Saving image quality adjustments (Save Memory)

Settings that can be saved in memory

Configuration menus p.26

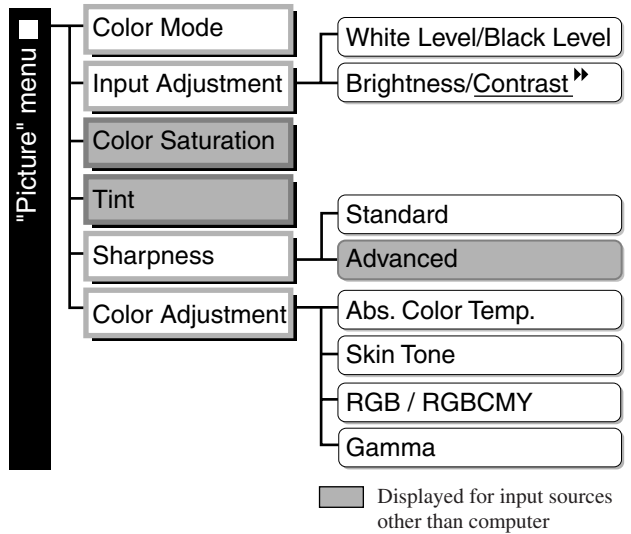

Press or on the remote control or or on the projector's control panel to select an item.
Press or to confirm the selection.



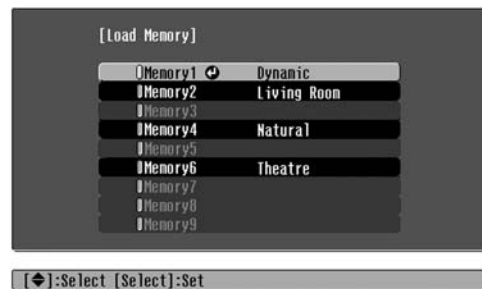

* If you press , the menu disappears.

Retrieving image quality adjustments (Load Memory)







This can be used to save adjusted values for all of the configuration menu items on the left. The "Save Memory" command in the "Memory" menu is used to save the settings.

The following describes how to save settings.

- 1** Adjust the desired settings that you would like to save in memory.
- 2** Select "Save Memory" from the "Memory" menu and then press  or .
- 3** Select a memory name from Memory1 to Memory9 to use for saving and then press  or .

The status of a memory area is indicated by the colour of the  symbol to the left of the memory name as follows.

 Green : Memory area is in use  Grey : Memory area is not in use  Orange : Selected
In addition, if the memory has been registered, the colour mode selected when the memory was registered is displayed on the right side.

If you select a memory area that is already in use and press  or , the existing contents will be erased and the current settings will be saved in their place.

To erase all memory contents, select "Reset Memory" from the "Memory" menu.  p.33

You can press  and select the desired memory name from the menu.



TIP

- The colour mode selected when the memory was registered is displayed on the right side.
- Memory settings that have been applied to images will be retained even when the projector's power is turned off. The same memory adjustment settings will be applied to images that are projected the next time the projector's power is turned on.
- The **aspect** setting retrieved from memory may not be applied to the images if they are 16:9 images or if the input signal images have a particular resolution.

Configuration Menu Functions

The configuration menus can be used to make a variety of adjustments and settings involving the screen, image quality and input signals.

The following two types of menu are available.

■ Full menu

All items in the configuration menu can be checked while the settings are being made.

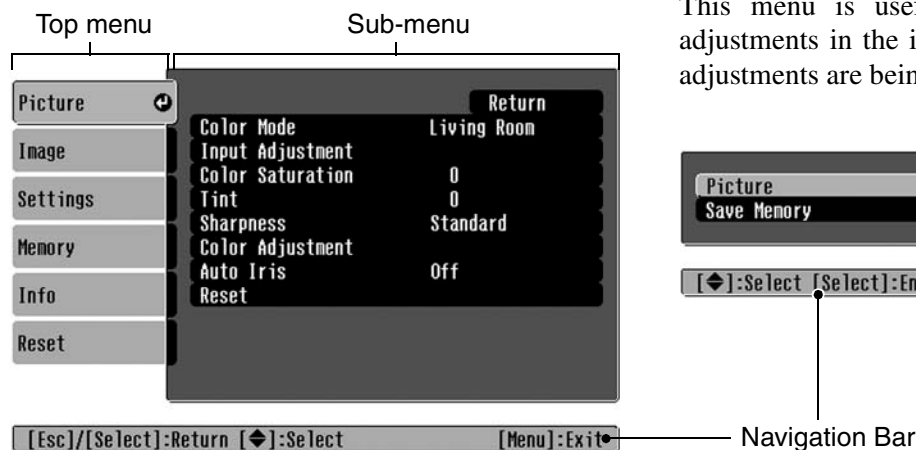

■ Line menu

This lets you adjust some areas of the "Picture" menu and "Memory" menu in the configuration menu.

This menu is useful for viewing the effects of adjustments in the images being projected while the adjustments are being made.



Refer to "Using the configuration menus" (p.34) for details on menu operations.



TIP

The configuration menu can be used to turn the navigation bar on and off and to change the colour pattern and display position.

☞ "Settings" - "Display" - "Menu Position", "Navigation Bar", "Menu Color"

List of configuration menus

If no image signals are being input, none of the settings can be adjusted except for "Reset" and "Auto Iris" in the "Picture" menu, or "Auto Setup" in the "Image" menu. The items displayed in the "Picture" menu, the "Image" menu and the "Info" menu will vary depending on the type of image signals that are being projected.

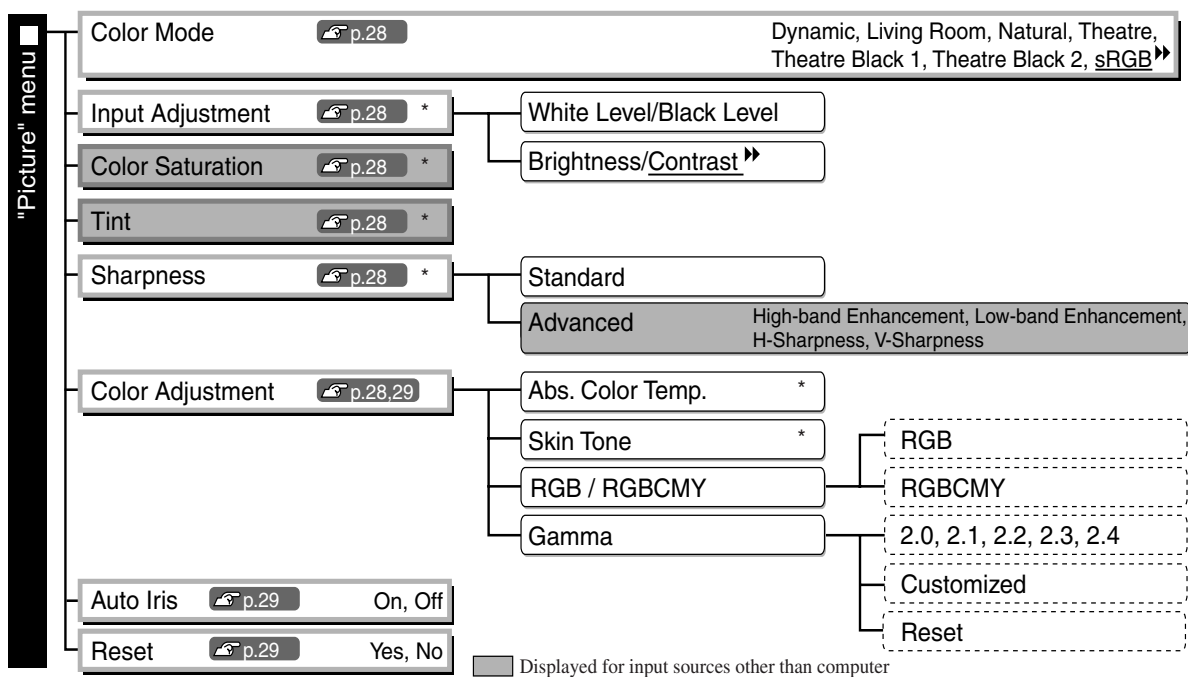

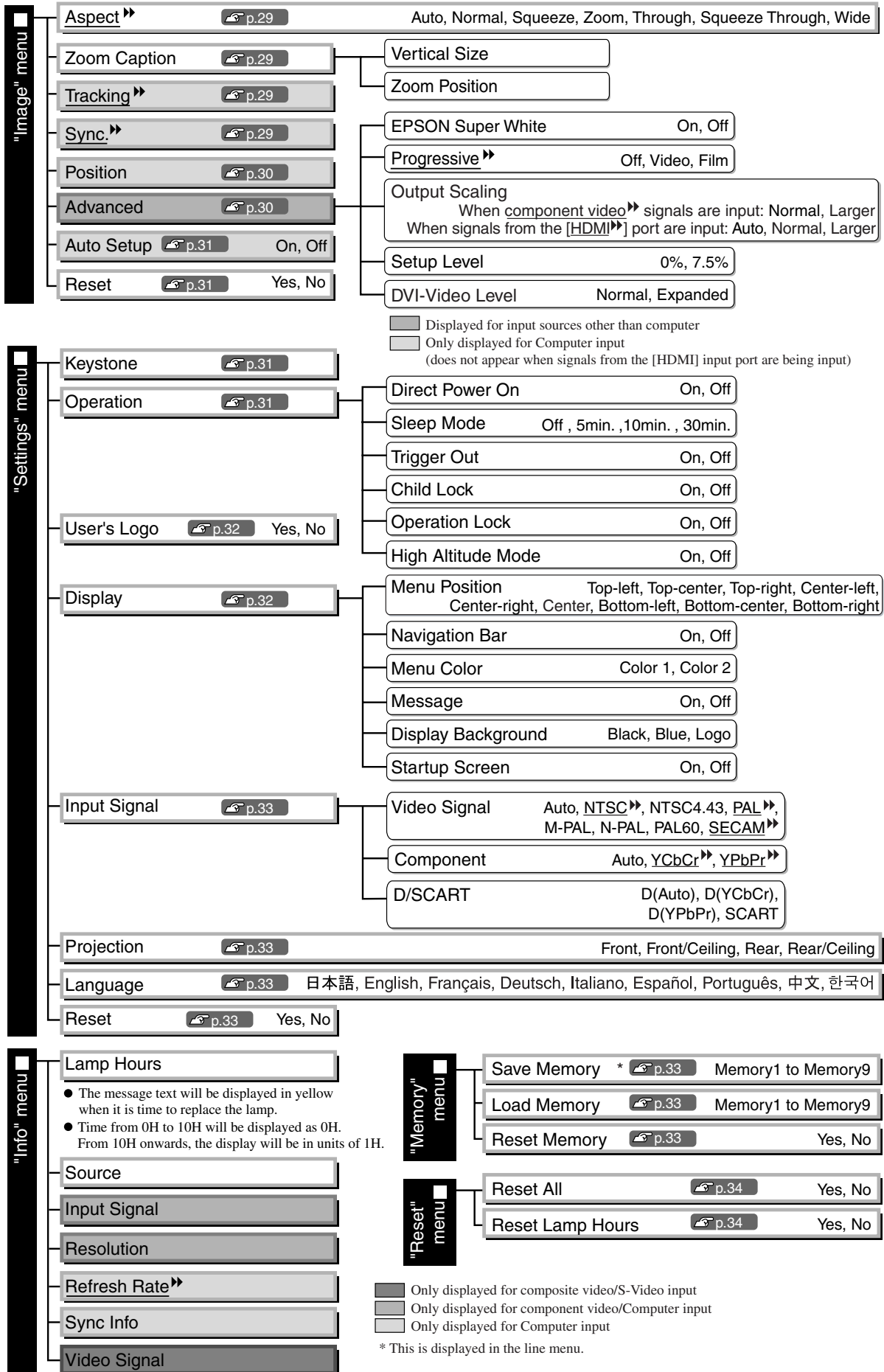

The "Info" menu is only used to display the projector status.

"Picture" menu

 Displayed for input sources other than computer

Color Mode *1

Seven different settings can be selected for the Color Mode, to match the images being projected or the projection environment.  p.18

Input Adjustment *2

These settings can be adjusted if the output level from the connected equipment is weak and the images appear dark. The two settings cannot be made simultaneously. You can only select one of them to be adjusted.

White Level/Black Level

These adjust the dark and light areas of images

- White Level: Adjusts the brightness of bright shades without changing the black level.
When the setting is changed to the - side, bright areas become clearer.
- Black Level: Adjusts the brightness of dark shades without changing the white level.
When the setting is changed to the + side, dark areas become clearer.

Brightness/Contrast



Adjusts the overall brightness of the images.

- Brightness: The brightness of the images can be adjusted.
If projecting in dark rooms or onto small screens and the images appear too bright, decrease the setting.
- Contrast: Adjusts the difference between bright and dark areas.
When the contrast is increased, images with greater modulation are obtained.

Color Saturation *2

This adjusts the colour intensity for the images.

Tint *2

(Adjustment is only possible when composite video  and S-Video  signals in NTSC  format are being input.)

This adjusts the image tint.

Sharpness *2

This adjusts the image sharpness.

Standard

The adjustment results are applied to the entire image.

Advanced

This can be used to adjust a specific region.  p.23

Color Adjustment

“Color Adjustment” cannot be selected when the colour mode is set to “sRGB ”.

Abs. Color Temp. *2

This adjusts the overall tints of the images.  p.20

*1 The setting values are stored separately for each image source and signal type.

*2 The setting values are stored separately for each image source and colour mode setting.

Only displayed for Computer input
(does not appear when signals from the [HDMI] input port are being input)

Skin Tone *2

This adjusts the skin tones of people who appear in the images. p.20

RGB/RGBCMY *1

- RGB : This lets you adjust the offset and gain for each of the R/G/B colour components. p.22
- RGBCMY : This lets you adjust the hue and saturation for each of the R/G/B/C/M/Y colour components. p.22

Gamma *1

This adjusts gamma. You can select a value, or make adjustments while viewing an image or a graph. p.20

Auto Iris *3

The amount of light is adjusted appropriately depending on images (On)/ or not adjusted (Off). p.23

Reset

This returns all settings in the "Picture" menu to their default settings.

"Image" menu

Aspect ▶ *1

Selects the aspect mode. p.18

Zoom Caption *1

If "Aspect" is set to "Zoom" when viewing images with subtitles, change the setting as follows so that the subtitles are visible. The vertical size and the display position can both be adjusted together.

Vertical Size

The vertical size of the image is reduced so that the subtitles are displayed.

Zoom Position

The whole of the image is moved up so that the subtitles are displayed.

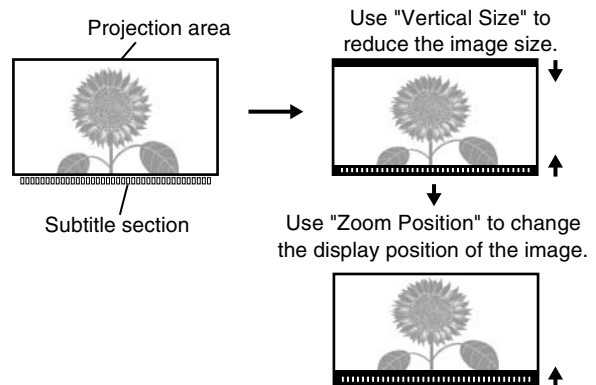

Tracking ▶ *1

This adjusts the images if vertical stripes appear in the images.

Sync. ▶ *1





This adjusts the images if flickering, fuzziness or interference appear in the images.

- Flickering and fuzziness may also appear in images when the brightness, contrast▶, sharpness and keystone correction settings are adjusted.
- Clearer adjustments can be obtained if you adjust the "Tracking" first and then adjust the "Sync".

*1 The setting values are stored separately for each image source and signal type.
*2 The setting values are stored separately for each image source and colour mode setting.
*3 The setting values are stored separately for each colour mode setting.

 Displayed for input sources other than computer

Position *1

(Setting is not possible when signals are being input from the [HDMI] input port.)
Use , ,  and  to move the display position for images.

Advanced

EPSON Super White *1

(Setting is only possible when Color Mode is "Natural", "Theatre", "Theatre Black 1", or "Theatre Black 2", and composite video, S-video, component video, or SCART signals are being input.)
If bright white areas of images such as clouds and T-shirts on the beach in summer appear uneven and overexposed, set to "On". When set to "On", the "DVI-Video Level" setting will be ignored.

Progressive *1

(Setting is only possible when composite video, S-video, 525i or 625i component video, or SCART signals are being input.)

Interlace (i) signals are converted to progressive (p) signals using a method appropriate for the image.

- Off : This is ideal for using when viewing images with a large amount of movement.
- Video : This is ideal for general video images.
- Film : When the input source is a film, the image equivalent with its original source will be projected.

Output Scaling *1

(Setting is not possible when composite video, S-Video, or computer signals are being input.)

This changes the display area (the part of projected images).

- Normal (92% display) : Input signals are projected at the normal image size. TV images are displayed at 92% size.
- Larger (100% display) : The areas at the top, bottom and sides of images that cannot normally be seen are inserted and projected. Interference may occur at the top or bottom of the images depending on the image signal. In such cases, try to adjust the display position ("Position").  p.30
- Auto : Displayed when the signals from [HDMI] input port are being input. Signals are automatically projected at 100% or 92% size depending on the input signals. (Not displayed when the equipment's DVI port is connected to the projector's [HDMI] input port.)

Setup Level *1

(Setting is only possible when composite video or S-Video signals in NTSC format are being input or when component video or RGB video is selected as an image source. Setting is not possible when computer signals are being input.)

If using products designed for destinations such as South Korea that have different black level (setup level) settings, use this function to obtain correct images. Check the specifications of the connected equipment when changing this setting.

DVI-Video Level *1

(Setting is only possible when "EPSON Super White" is set to "Off".)

If the projector's [HDMI] input port is connected to the DVI port of a DVD player or similar equipment using an HDMI/DVI cable, set the video level for the projector to match the video level that has been set at the DVD player. The setting at the DVD player can be either Normal or Expand.

Only displayed for Computer input
(does not appear when signals from the [HDMI] input port are being input)

Auto Setup

This sets automatic adjustment to on or off in order to set whether the projector automatically adjusts images to their optimum condition when the input signal is changed. The three automatically adjusted items are "Tracking▶", "Position" and "Sync▶".

Reset

All the adjustment values on the "Image" menu, except "Aspect▶", are returned to their default values.

"Settings" menu



Keystone

(If the aspect mode is set to "Wide", keystone correction cannot be set.)

This is used to correct keystone distortion in images. The same correction can be carried out using the projector's control panel.  p.17

Operation

Direct Power On

When the main power switch is turned on, you can set for projection to start (On) / not start (Off) without pressing  or .

When set to "On" with the power left on, be aware that sudden surges of electricity that may occur when the power comes back on after a power outage may cause the projector to turn on.

Sleep Mode

The projector is equipped with a power-saving function that causes the power to turn off automatically and the projector to switch to standby if no signal is input to the projector for a continuous length of time. The length of time before the power-saving function operates can be selected from four available settings. If "Off" is selected, the power-saving function will not operate.



If you press  while the projector is in standby mode, projection will start again.

Trigger Out

This turns the trigger function on and off to determine whether the projector's power on/off status and problems with projector operation are communicated to an external device.

If you change the setting, the new setting will take effect after the power has been turned off and the cool-down▶ period is complete.



Child Lock

This locks the power on function of the  button on the projector's control panel, so that a child cannot accidentally turn the projector's power on and look into the projector's lens. When the lock is applied, the power will only turn on if  is pressed down for about 3 seconds.  can be used to turn off the power, and the remote control will continue to operate as normal.

If you change the setting, the new setting will take effect after the power has been turned off and the cool-down period is complete.

When the "Direct Power On" is set to "On", be aware that projection starts immediately as main power switch is turned on.

Operation Lock

If this is set to "On", you can't operate the projector's control panel buttons and a  icon appears on the screen when a button is pressed. To cancel, press and hold  on the projector's control panel for about seven seconds or more.

If you change the setting, the new setting will take effect after exiting the configuration menu.

High Altitude Mode

A fan is set at a certain speed of rotation so as to bring down internal temperature. When using above an altitude of about 1500m, set to "On".

User's Logo

You can record your favorite image as a user's logo.

The logo will be projected when projection starts and when using the blank function. When a user's logo is recorded, the previous user's logo will be erased. Follow the instructions on the screen to record a user's logo.

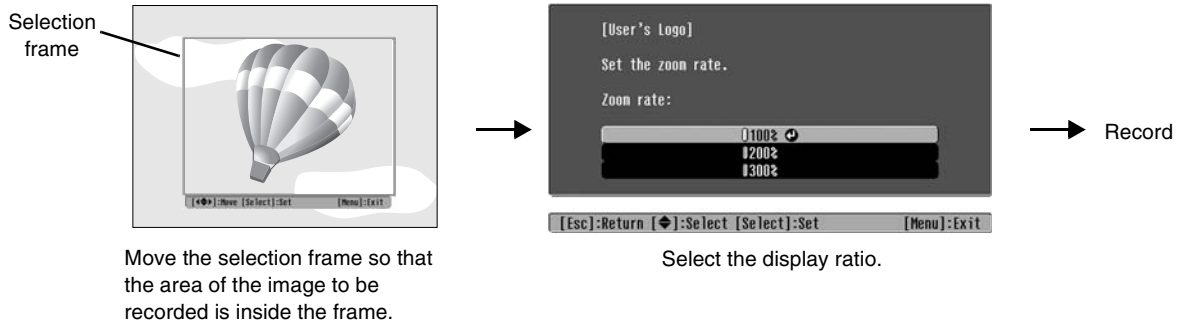

- The image will be displayed in dot format while the selection frame is displayed, therefore the display size may change.
- The size of the recorded image is 400 × 300 dots.
- Once a user's logo has been recorded, you cannot return the logo to the default setting.
- To use the recorded user's logo, set "Display Background" to "Logo".

Display

Menu Position

Press \uparrow , \rightarrow , \downarrow and \leftarrow to specify the position for the menus to be displayed.

Navigation Bar

This sets whether the navigation bar for the configuration menus is displayed (On) or not displayed (Off).

Menu Color

Selects the colour for the main configuration menu and the navigation bar.

- Color 1:Black
- Color 2:Purple

Message

This sets whether the following message displays appear (On) or don't appear (Off).

- Image signal, colour mode, aspect and item name when memory settings are retrieved
- Messages such as when no image signals are being input, when an incompatible signal is input, and when the internal temperature rises

Display Background

Displays a menu for selecting the screen status for when using the blank function or when no image signal is input.

Startup Screen

This sets whether the start-up screen (the image that is projected when projection starts) is displayed (On) or not displayed (Off).

If you change the setting, the new setting will take effect after the power has been turned off and the cool-down period is complete.

Input Signal

Video Signal

Sets the signal format in accordance with the video equipment that is connected to the [Video] or [S-Video] input port. If set to "Auto", the video signal format is set automatically.

If there is a lot of interference in the image, or if a problem such as no image being projected occurs even though "Auto" has been selected, select the correct signal format manually.

Component

Change this setting depending on the type of signal that is being output from the video equipment that is connected to the [Component] port.

If "Auto" is selected, appropriate signal is automatically set. If colours appear unnatural even though "Auto" is selected, select appropriate signal name in the menu.

D/SCART

This sets the signal format in accordance with the signals being output from video equipment that is connected to the [SCART] port (in Europe) or [D] port (in Japan).

Projection

This should be set in accordance with the method used to set up the projector.

- Front : Select when the projector is set up in front of the screen.
- Front/Ceiling : Select when the projector is set up in front of the screen and suspended from a ceiling.
- Rear : Select when the projector is set up behind the screen.
- Rear/Ceiling : Select when the projector is set up behind the screen and suspended from a ceiling.

Language

This sets the display language for messages and menus.

Reset

Adjustment values for the "Settings" menu functions are returned to their default settings, except for the "High Altitude Mode", "Component", "D/SCART", "Projection", and "Language".

"Memory" menu

Save Memory

This can be used to save "Picture" menu settings.  p.24

Load Memory

This retrieves settings previously saved using "Save Memory"  p.24

Reset Memory

This resets (erases) all settings that have been made using the "Save Memory".

"Reset" menu

Reset All

This resets all configuration menu settings to their default settings. The "Save Memory", "Component", "D/SCART" and "Language" settings will not be reset. The "Save Memory" is reset by "Reset Memory".

Reset Lamp Hours

This initialises the lamp operating time. When this command is selected, the cumulative operating time for the lamp is cleared and returned to the default setting.

Using the configuration menus

1 Displaying a menu

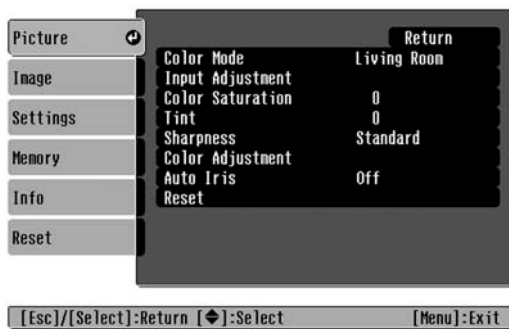

Full menu: Press .



Line menu: Press  or .





2 Selecting a menu item

Use  or  to select a menu item, then press .



3 Changing settings



Example:





Use  or  to adjust values.



 (green): Current setting value
 (orange): Currently-selected item

Use  or  to select an item, then press .

If you press  when an item with  next to it is selected, the selection screen for that item will be displayed.

To return to a previous display, press . Alternatively, select [Return] and then press .

4 When setting is complete

Press .

Reading the indicators

The projector is provided with the following two indicators which notify you of the operating status of the projector.



The following tables show what the indicators mean and how to remedy the problems that they indicate.

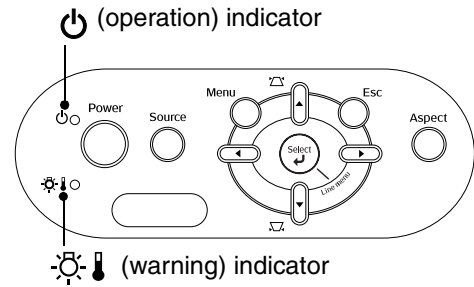



* If all indicators are switched off, check that the power cable is connected correctly and that the main power switch is on.

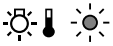

When the (warning) indicator is lit or flashing **warning/problem**

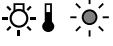

● : Lit  : Flashing

| | |
|---|--|
| <p>Red</p>  <p>(Lit/off for 1 sec)</p> | <p>Internal problem / Fan problem / Sensor problem / Cinema filter problem / Auto iris problem</p> <p style="text-align: center;">CAUTION</p> <p>Disconnect the power cable from the electrical outlet. Then contact your local dealer or the nearest address provided in the <i>World-Wide Warranty Terms</i>.  Inquiries</p> |
|---|--|

| | |
|---|---|
| <p>Red</p>  <p>(Lit/off for 0.5 sec)</p> | <p>Lamp problem / Lamp on error / Lamp cover open error</p> <p>Check if the lamp is broken.  p.44 Clean the air filter.  p.42</p> <p>If the lamp is not broken</p> <div style="border: 1px solid gray; padding: 5px; margin: 5px;"> <p>Replace the lamp and then turn the power on.</p> </div> <p>If the problem is still not solved after the lamp is replaced, stop using the projector and disconnect the power cable from the electrical outlet. Then contact your local dealer or the nearest address provided in the <i>World-Wide Warranty Terms</i>.  Inquiries</p> <p>If the lamp is broken</p> <div style="border: 1px solid gray; padding: 5px; margin: 5px;"> <p>Contact your local dealer for further advice.</p> </div> |
|---|---|

Check that the lamp and the lamp cover are securely installed.



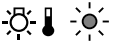



When using above an altitude of about 1500 m, make sure you set the "High Altitude Mode" to "On".  p.32

| | |
|---|--|
| <p>Red</p>  | <p>High internal temperature (overheating)</p> <p>The lamp will switch off automatically and projection will stop. Wait for approximately 5 minutes. When the cooling fan stops, turn off the main power switch at the rear of the projector.</p> <div style="border: 1px solid gray; padding: 5px; margin: 5px;"> <ul style="list-style-type: none"> • If the projector is installed against a wall, leave a space of 20 cm or more between it and the wall. • Clean the air filters if they are blocked.  p.42 </div> <p>If the problem is not solved when the power is turned back on, stop using the projector, turn off the main power switch, and disconnect the power cable from the electrical outlet. Then contact your local dealer or the nearest address provided in the <i>World-Wide Warranty Terms</i>.  Inquiries</p> |
| <p>Orange</p>  | <p>High-speed cooling in progress</p> <p>You can continue using the projector, but if the temperature rises again, it will switch off automatically.</p> |

When the (operation) indicator is lit or flashing **normal**

When the  (warning) indicator is off











●: Lit : Flashing

| | |
|---|---|
| <div style="border: 1px solid black; padding: 2px; width: fit-content; margin: 0 auto;"> Orange  ● </div> | <p>Standby condition</p> <p>If you press _{On}, projection will start after a brief interval.</p> |
| <div style="border: 1px solid black; padding: 2px; width: fit-content; margin: 0 auto;"> Green   </div> | <p>Warm-up in progress</p> <p>Warm-up time is approximately 30 seconds. Power off operations are ignored while warm-up is in progress.</p> |
| <div style="border: 1px solid black; padding: 2px; width: fit-content; margin: 0 auto;"> Green  ● </div> | <p>Projection in progress</p> <p>Normal operation is in progress.</p> |
| <div style="border: 1px solid black; padding: 2px; width: fit-content; margin: 0 auto;"> Orange   </div> | <p>Cool-down[»] in progress</p> <p>Cool-down time is approximately 30 seconds. After cool-down is complete, the projector goes to standby mode. You cannot use the remote control or the projector's control panel during cool-down. If the main power switch at the rear of the projector is turned off before cool-down is complete, wait for the lamp to cool down (normally about one hour is required) before turning the power back on again.</p> |

When the indicators provide no help

If any of the following problems occur and the indicators do not offer a solution, refer to the pages given for each problem.

Problems relating to images

- **No images appear**  p.37
Projection does not start, the projection area is completely black, the projection area is completely blue, etc.
- **Moving images are not displayed**  p.37
Moving images played on computer are not displayed.
- **The message "Not Supported." is displayed**  p.38
- **The message "No Signal." is displayed**  p.38
- **Images are fuzzy or out of focus**  p.38
- **Interference or distortion appear in images**  p.39
Problems such as interference, distortion or black & white checked patterns appear.
- **Image is truncated (large) or small**  p.39
Only part of the image is displayed.
- **Image colours are not right**  p.40
The whole image appears purplish or greenish, images are black & white, colours appear dull, etc.
(Computer monitors and LCD screens have different colour reproduction performance, so that the colours projected by the projector and the colours appearing on the monitor may not necessarily match, but this is not a sign of a problem.)
- **Images appear dark**  p.40
- **Projection stops automatically**  p.41

Problems when projection starts













- **Power does not turn on**  p.41

Problems with the remote control

- **The remote control does not work**  p.41

Problems relating to images

■ No images appear

| | |
|---|---|
| Have you pressed the [Power] button? | Press  on the remote control or  on the projector's control panel. |
| Is the main power switch turned off? | Turn on the main power switch at the rear of the projector. |
| Are all of the indicators switched off? | Disconnect the power cable and then reconnect it.  p.14 Check the circuit breaker to see if power is being supplied. |
| Is blank mode active? | Press  on the remote control to cancel the blank function. |
| Is a video signal being input? | Check that the power for the connected equipment is turned on. If the "Message" menu command has been set to "On", messages relating to the image signals will be displayed.  "Settings" - "Display" - "Message" p.32 |
| Are the image signal format settings correct? | <p>If a <u>composite video</u> or <u>S-Video</u> signal is being input If projection does not occur when the "Video Signal" menu command is set to "Auto", select the signal format that matches the signal source.  "Settings" - "Input Signal" - "Video Signal" p.33</p> <p>If the signal source is connected to the [Component] port If projection does not occur when the "Component" in the "Input Signal" menu command is set to "Auto", set the signal format that matches the signal that is being projected from the connected equipment.  "Settings" - "Input Signal" - "Component" p.33 You can also press  on the remote control to select the format.  p.15</p> <p>If the VCR or DVD equipment is connected using a D SCART adapter Press  to set the signal format to "D/SCART".  p.15 When still no images appear and the DVD equipment is connected, change the setting at the DVD equipment to RGB output.</p> |
| Have the configuration menu settings been made correctly? | Try resetting all of the current settings.  p.34 |
| Were the projector and computer connected while their power was already turned on? | If the connection is made while the power is already turned on, the function (Fn) key that switches the computer's video signal to external output may not work. Turn the power for the computer that is connected to the projector off and then back on again. |

When a computer is connected

■ Moving images are not displayed







| | |
|--|--|
| Is the computer image signal set to output simultaneously both externally and to the LCD monitor? | Set the image signal to output only externally.  Computer documentation, under a title such as "External output" or "Connecting an external monitor" |
|--|--|

Only when projecting images from a laptop computer or computer with a built-in LCD screen

■ The message "Not Supported." is displayed

| | |
|---|--|
| <p>Are the image signal format settings correct?</p> | <p>If a <u>composite video</u> or <u>S-Video</u> is being input If projection does not occur when the "Video Signal" menu command is set to "Auto", select the signal format that matches the signal source. ☞ "Settings" - "Input Signal" - "Video Signal" p.33</p> <hr/> <p>If the signal source is connected to the [Component] port If projection does not occur when the "Component" in the "Input Signal" menu command is set to "Auto", set the signal format that matches the signal that is being projected from the connected equipment. ☞ "Settings" - "Input Signal" - "Component" p.33 You can also press , on the remote control to select the format. ☞ p.15</p> |
| <p>Does the mode match the frequency and resolution of the image signals?</p> <p>Only when projecting computer images</p> | <p>Use the "Resolution" menu command to check the signals being input, and check the "List of Supported Monitor Displays" to make sure that the signals are compatible. ☞ "Info" - "Resolution" p.27 ☞ "List of Supported Monitor Displays" p.47</p> |

■ The message "No Signal." is displayed

| | |
|--|---|
| <p>Are the cables connected correctly?</p> | <p>Check that all of the cables required for projection are securely connected. ☞ p.12</p> |
| <p>Has the correct video input port been selected?</p> | <p>Press , , ,  or  on the remote control or  on the projector's control panel to change the image source. ☞ p.15</p> |
| <p>Is the power for the connected equipment turned on?</p> | <p>Turn the power on for the devices.</p> |
| <p>Are the image signals being output to the projector?</p> <p>Only when projecting images from a laptop computer or computer with a built-in LCD screen</p> | <p>If the image signals are only being output to the computer's LCD monitor, you need to change the output. For some computer models, when the image signals are output externally, they no longer appear on the LCD monitor. ☞ Computer documentation, under a title such as "External output" or "Connecting an external monitor"</p> <hr/> <p>If the connection is made while the power is already turned on, the function [Fn] key that switches the computer's video signal to external output may not work. Turn the power for the projector and the computer off and then back on again. ☞ p.14</p> |

■ Images are fuzzy or out of focus

| | |
|---|--|
| <p>Has the focus been adjusted correctly?</p> | <p>Adjust the focus. ☞ p.16</p> |
| <p>Is the lens cover still attached?</p> | <p>Remove the lens cover.</p> |
| <p>Is the projector at the correct distance?</p> | <p>The recommended distance from the projector to the screen is within 93-2035 cm (3.0-66.8 ft.) for a screen size of 16:9, and 113-2490 cm (3.7-81.7 ft.) for a screen size of 4:3. Set up the projector so that the projection distance is within this range. ☞ p.10</p> |
| <p>Is the keystone adjustment value too large?</p> | <p>Decrease the projection angle to reduce the amount of keystone correction. ☞ p.17</p> |

| | |
|--|---|
| <p>Has condensation formed on the lens?</p> | <p>If the projector is suddenly taken from a cold environment to a warm environment or if sudden ambient temperature changes occur, condensation may form on the surface of the lens, and this may cause the images to appear fuzzy. Set the projector up in the room approximately one hour before it is to be used. If condensation forms on the lens, turn the power off and wait for the condensation to disappear.</p> |
|--|---|

■ **Interference or distortion appear in images**

| | |
|---|---|
| <p>Are the image signal format settings correct?</p> | <p>If a <u>composite video</u> or <u>S-Video</u> is being input If projection does not occur when the "Video Signal" menu command is set to "Auto", select the signal format that matches the signal source. ☞ "Settings" - "Input Signal" - "Video Signal" p.33</p> <hr/> <p>If the signal source is connected to the [Component] port If projection does not occur when the "Component" in the "Input Signal" menu command is set to "Auto", set the signal format that matches the signal that is being projected from the connected equipment. ☞ "Settings" - "Input Signal" - "Component" p.33 You can also press  on the remote control to select the format. ☞ p.15</p> |
| <p>Are the cables connected correctly?</p> | <p>Check that all of the cables required for projection are securely connected. ☞ p.12</p> |
| <p>Is an extension cable being used?</p> | <p>If an extension cable is used, interference may increase. Try connecting a signal amplifier.</p> |
| <p>Have the "Sync." and "Tracking" settings been adjusted correctly?</p> <p>Computer and RGB video signals only</p> | <p>The projector has an automatic adjustment function that causes the optimum images to be projected. However, for some types of signal, the correct adjustments may not be obtained even after automatic adjustment is carried out. In such cases, use the "Tracking" and "Sync." menu commands to make the adjustments. ☞ "Image" - "Tracking", "Sync." p.29</p> |
| <p>Has the correct resolution been selected?</p> <p>Only when projecting computer images</p> | <p>Set the computer so that the signals that are output are compatible with this projector. ☞ "List of Supported Monitor Displays" p.47 Computer documentation</p> |

■ **Image is truncated (large) or small**

| | |
|--|---|
| <p>Has the correct <u>aspect</u> been selected?</p> | <p>Press  to select the aspect that corresponds to the input signal. ☞ p.18 If images with subtitles are being projected using "Zoom", use the "Zoom Caption" menu command to adjust the images. ☞ p.29</p> |
| <p>Has the "Position" setting been adjusted correctly?</p> | <p>Use the "Position" the menu command to make the adjustment. ☞ "Image" - "Position" p.30</p> |
| <p>Has the computer been set for dual display?</p> <p>Only when projecting computer images</p> | <p>If dual display has been activated in the Display Properties of the computer's Control Panel, the projector will only project about half of the image on the computer screen. To display the whole of the image on the computer screen, turn off the dual display setting. ☞ Computer video driver documentation</p> |

| | |
|---|---|
| <p>Has the correct resolution been selected?</p> | <p>Set the computer so that the signals that are output are compatible with this projector.</p> |
| <p>Only when projecting computer images</p> | <p>☞ "List of Supported Monitor Displays" p.47 Computer documentation</p> |



■ **Image colours are not right**

| | |
|---|--|
| <p>Are the image signal format settings correct?</p> | <p>If a <u>composite video</u> or <u>S-Video</u> is being input If projection does not occur when the "Video Signal" menu command is set to "Auto", select the signal format that matches the signal source.</p> |
| | <p>☞ "Settings" - "Input Signal" - "Video Signal" p.33</p> |
| | <p>If the signal source is connected to the [Component] port If projection does not occur when the "Component" in the "Input Signal" menu command is set to "Auto", set the signal format that matches the signal that is being projected from the connected equipment. ☞ "Settings" - "Input Signal" - "Component" p.33 You can also press  on the remote control to select the format. ☞ p.15</p> |
| <p>Are the cables connected correctly?</p> | <p>Check that all of the cables required for projection are securely connected. ☞ p.12</p> |
| <p>Has the image contrast been adjusted correctly?</p> | <p>Use the "Contrast" or the "White Level" menu command to adjust the contrast. ☞ "Picture" - "Input Adjustment" - "Brightness/Contrast", "White Level/Black Level" p.28</p> |
| <p>Has the colour been adjusted correctly?</p> | <p>Use the "Color Adjustment" menu command to adjust the colour. ☞ "Picture" - "Color Adjustment" p.28</p> |
| <p>Have the colour intensity and tint been adjusted correctly?</p> | <p>Use the "Color Saturation" and "Tint" menu commands to adjust the colour and tint.</p> |
| <p>Only when projecting images from a video source</p> | <p>☞ "Picture" - "Color Saturation", "Tint" p.28</p> |

■ **Images appear dark**









| | |
|---|--|
| <p>Has the image brightness been adjusted correctly?</p> | <p>Use the "Brightness" menu commands to make the adjustments. ☞ "Picture" - "Input Adjustment" - "Brightness/Contrast" p.28</p> |
| <p>Has the image contrast been adjusted correctly?</p> | <p>Use the "Contrast" or the "White Level" menu command to adjust the contrast. ☞ "Picture" - "Input Adjustment" - "Brightness/Contrast", "White Level/Black Level" p.28</p> |
| <p>Is the lamp due for replacement?</p> | <p>When the lamp is nearly due for replacement, the images will become darker and the colour quality will become poorer. When this happens, the lamp should be replaced with a new one. ☞ p.44</p> |

■ **Projection stops automatically**

| | |
|------------------------------|---|
| Is sleep mode active? | <p>When "Sleep Mode" has been set to On, the lamp turns off automatically if no signal is input for about 30 minutes, and the projector switches to standby mode. Press the  button on the remote control or the  button on the projector's control panel to turn the projector's power back on. To cancel the sleep mode setting, change "Sleep Mode" menu command to "Off".  "Settings" - "Operation" - "Sleep Mode" p.31</p> |
|------------------------------|---|



Problems when projection starts

■ **Power does not turn on**

| | |
|---|---|
| Have you pressed the [Power] button? | <p>Press  on the remote control or  on the projector's control panel.</p> |
| Is "Child Lock" set to "On"? | <p>If the "Child Lock" menu command is set to "On", press  on the projector's control panel for about 3 seconds or press  on the remote control to turn the power on.  "Settings" - "Operation" - "Child Lock" p.31</p> |
| Is "Operation Lock" set to "On"? | <p>If the "Operation Lock" menu command is set to "On", all buttons on the projector's control panel are disabled. Press  on the remote control.  "Settings" - "Operation" - "Operation Lock" p.31</p> |
| Are all of the indicators switched off? | <p>Disconnect the power cable and then reconnect it.  p.14 Check the circuit breaker to see if power is being supplied.</p> |
| Do the indicators turn off and on when the power cable is touched? | <p>Turn the power off, disconnect the power cable and then reconnect it. If this does not solve the problem, there may be a problem with the power cable. Then contact your local dealer or the nearest address provided in the <i>World-Wide Warranty Terms</i>.  Inquiries</p> |

Problems with the remote control

■ **The remote control does not work**

| | |
|--|--|
| Is the remote control light-emitting area facing towards the remote control light-receiving area when it is operated? | <p>Face the remote control towards the remote control light-receiving area. The operating angle for the remote control is approximately $\pm 30^\circ$ horizontally and approximately $\pm 30^\circ$ vertically.  p.13</p> |
| Is the remote control too far from the projector? | <p>The operating range for the remote control is approximately 10m.  p.13</p> |
| Is direct sunlight or strong light from fluorescent lamps shining onto the remote control light-receiving area? | <p>Set the projector up in a location where strong light will not shine onto the remote control light-receiving area.</p> |
| Are the batteries dead, or have the batteries been inserted correctly? | <p>Insert new batteries, while making sure that they face correctly.  p.13</p> |

This section describes maintenance tasks such as cleaning the projector and replacing consumable parts.

Cleaning

You should clean the projector if it becomes dirty or if the quality of projected images starts to deteriorate.

CAUTION Be sure to read the separate *Safety Instructions/World-Wide Warranty Terms* booklet for details on safe handling of the projector during cleaning.

Cleaning the air filter

If the air filter becomes blocked with dust and the message "The projector is overheating. Make sure nothing is blocking the air vent, and clean or replace the air filter" is displayed, clean the air filter.

Turn the projector upside-down and use a vacuum cleaner to clean the air filter

CAUTION If the air filter becomes clogged with dust, it can result in overheating which may cause operating problems or reduce the operating life of the optical parts. It is recommended that you clean the air filter about once every three month. If using the projector in a dusty location, the air filter should be cleaned more often.

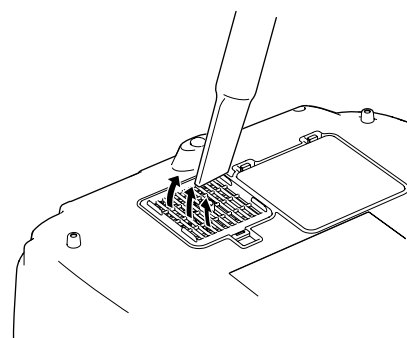

Cleaning the projector case

Clean the projector case by wiping it gently with a soft cloth. If the projector is particularly dirty, moisten the cloth with water containing a small amount of neutral detergent, and then firmly wring the cloth dry before using it to wipe the projector case. Then wipe the case again with a soft, dry cloth.

CAUTION Do not use volatile substances such as wax, alcohol or thinner to clean the projector case. These can cause the case to warp and make the coating finish peel off.

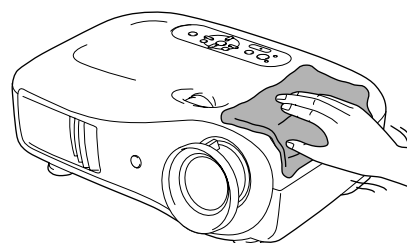

Cleaning the lens

To clean the lens it is preferable to use an air blower purchased for the purpose. But alternatively you can wipe it gently clean with a spectacle-cleaning cloth.

CAUTION Do not rub the lens with harsh materials or subject the lens to shocks, as it can easily become damaged.

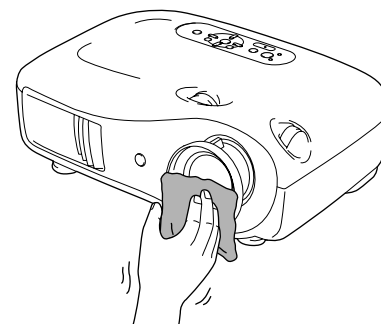

Consumable replacement periods

Air filter replacement period

- If the air filter has been broken or the "Replace" message is displayed even though the air filter has been cleaned.

Replace with an optional air filter.

 Replacing the air filter p.44

Lamp replacement period

- The message "Replace the lamp." appears on the screen when projection starts.

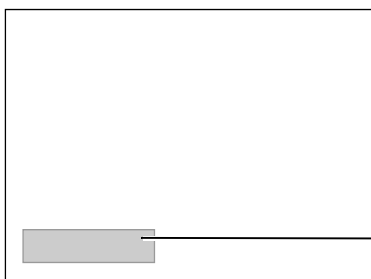

A message will be displayed.

- The projected images get darker or start to deteriorate.



TIP

- The replacement warning message is set to appear after a minimum of about 1600 hours of lamp use in order to maintain the initial brightness and quality of the projected images. The time taken for the message to appear will vary depending on usage conditions such as Color Mode settings. If you continue to use the lamp after this period, the possibility of the lamp breaking becomes greater. When the lamp replacement message appears, replace the lamp with a new one as soon as possible, even if it is still working.
- Depending on the characteristics of the lamp and on the way it has been used, the lamp may become darker or stop working before the lamp warning message appears. You should always have a spare lamp ready in case it is needed.
- Contact your dealer for a spare lamp.

Replacing consumables

Replacing the air filter



TIP

Dispose of used air filters properly in accordance with your local regulations.
Air Filter:
Polypropylene

1 Press **Off** or **Power** to turn the power off, wait until the projector cools down, and then turn off the main power switch.

2 Remove the air filter cover.

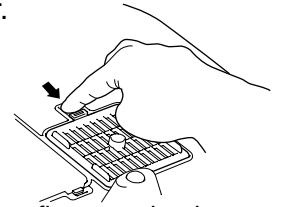

Put your finger under the latch and pull it upward.

Replacing the lamp

CAUTION

If the lamp stops working and needs to be replaced, there is the danger that the lamp may already be broken. If replacing the lamp of a projector which has been installed to the ceiling, you should always assume that the lamp is broken and handle it with extreme care during removal. Furthermore, you should stand to the side of the projector, not underneath it.

1 Press **Off** or **Power** to turn the power off, wait until the projector cools down, and then turn off the main power switch.

* Wait until the lamp cools down (takes approximately 1 hour).

2 Remove the lamp cover.

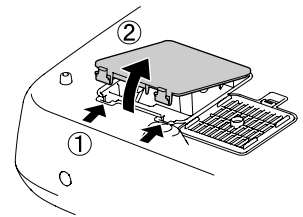

6 Securely tighten the lamp fixing screws.

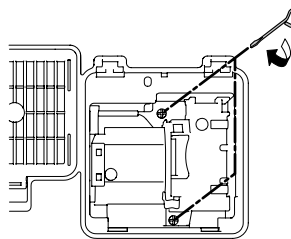

7 Install the lamp cover.

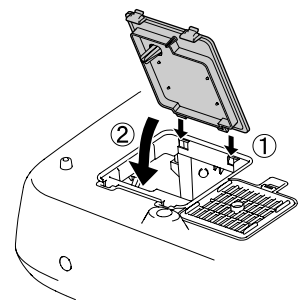

Resetting the lamp operating time

The lamp operating time must always be reset after the lamp has been replaced with a new one.

The projector has a built-in counter which keeps track of the lamp operating time. When the cumulative operating time reaches a certain point, it causes the replacement warning message to be displayed.

1 Press **On** to turn on the power.

2 Press **Menu** to display the configuration menu.



3 Remove the old air filter.

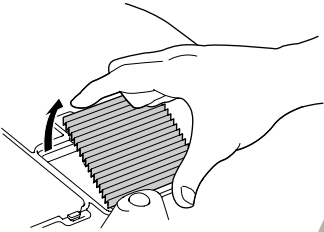

4 Insert the new air filter.

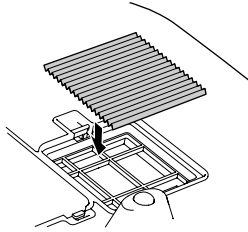

5 Install the air filter cover.

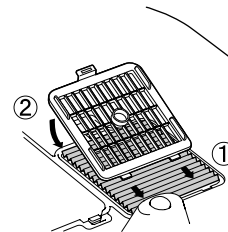

3 Loosen the lamp fixing screws.

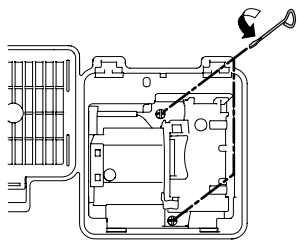

4 Remove the old lamp.

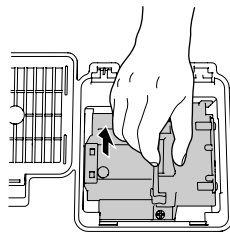

Pull out straight.

5 Insert the new lamp.

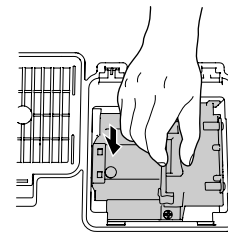

Make sure that it faces the correct way.

CAUTION

- Install the lamp and the lamp cover securely. The lamp will not turn on if the lamp or the lamp cover is not installed correctly.
- This product includes a lamp component that contains mercury (Hg). Please consult your local regulations regarding disposal or recycling. Do not dispose of it with normal waste.

3 Select "Reset Lamp Hours" from the "Reset" menu.



4 Select "Yes" and then press .



Optional Accessories / Consumables

The following optional accessories / consumables are available for purchase if required. This list of optional accessories / consumables is current as of October, 2006. Details of accessories are subject to change without notice.

Varies depending on country of purchase.

■ Optional Accessories

| | |
|---------------------|---------|
| 50" Portable Screen | ELPSC06 |
|---------------------|---------|

A compact screen which can be carried easily.
(Aspect▶▶ 4:3)

| | |
|----------------------|---------|
| 60" Portable Screen | ELPSC07 |
| 80" Portable Screen | ELPSC08 |
| 100" Portable Screen | ELPSC10 |

A portable roll-type screen. (Aspect 4:3)

| | |
|---------------------------|---------|
| VGA-HD15 PC Cable (1.8 m) | ELPKC02 |
| VGA-HD15 PC Cable (3 m) | ELPKC09 |
| VGA-HD15 PC Cable (20 m) | ELPKC10 |

(For mini D-Sub 15-pin/mini D-Sub 15-pin)
Use to connect the projector to a computer.

| | |
|----------------|---------|
| Ceiling Mount* | ELPMB20 |
|----------------|---------|

(with ceiling plate)
Use when installing the projector to a ceiling.

| | |
|----------------------------------|---------|
| Celling Pipe 600 (600 mm/white)* | ELPFP07 |
|----------------------------------|---------|

Use when installing the projector to a high ceiling or a ceiling with veneer panels.

* A special method of installation is required in order to suspend the projector from the ceiling. Please contact the place of purchase if you would like to use this installation method.

■ Consumables

| | |
|-----------|---------|
| Lamp Unit | ELPLP39 |
|-----------|---------|

(1 spare lamp, 1 spare screwdriver)
Use as a replacement for spent lamps.

| | |
|----------------|---------|
| Air Filter Set | ELPAF09 |
|----------------|---------|

(1 air filter)
Use as a replacement for old air filters.

List of Supported Monitor Displays

Depending on the setting, the output screen resolution will change slightly.

Component Video

4:3 16:9 : Aspect Units: Dots

| Signal | Resolution | Aspect mode | | | | | |
|-------------------|----------------------|------------------|------------------|------------------|------------------|-----------------|------------------|
| | | Normal | Squeeze | Zoom | Through | Squeeze through | Wide |
| SDTV (525i, 60Hz) | 720×480 720×360 * | 960×720 4:3 | 1280×720 16:9 | 1280×720 16:9 | 596×446 4:3 | 794×446 16:9 | 1280×760 16:9 |
| SDTV(625i, 50Hz) | 720×576 720×432 * | 960×720 4:3 | 1280×720 16:9 | 1280×720 16:9 | 708×528 4:3 | 944×528 16:9 | 1280×760 16:9 |
| SDTV(525p) | 720×480 720×360 * | 960×720 4:3 | 1280×720 16:9 | 1280×720 16:9 | 596×446 4:3 | 794×446 16:9 | 1280×760 16:9 |
| SDTV(625p) | 720×576 720×432 * | 960×720 4:3 | 1280×720 16:9 | 1280×720 16:9 | 708×528 4:3 | 944×528 16:9 | 1280×760 16:9 |
| HDTV (750p) 16:9 | 1280×720 | 1280×720 16:9 | - | - | 1176×664 16:9 | - | - |
| HDTV(1125i) 16:9 | 1920×1080 | 1280×720 16:9 | - | - | - | - | - |

*Letterbox signal

Composite Video/S-Video

4:3 16:9 : Aspect Units: Dots

| Signal | Resolution | Aspect mode | | | | | |
|----------------|----------------------|----------------|------------------|------------------|----------------|-----------------|------------------|
| | | Normal | Squeeze | Zoom | Through | Squeeze through | Wide |
| TV(NTSC) | 720×480 720×360 * | 960×720 4:3 | 1280×720 16:9 | 1280×720 16:9 | 596×446 4:3 | 794×446 16:9 | 1280×720 16:9 |
| TV(PAL, SECAM) | 720×576 720×432 * | 960×720 4:3 | 1280×720 16:9 | 1280×720 16:9 | 708×528 4:3 | 944×528 16:9 | 1280×720 16:9 |

*Letterbox signal

Images from Computer

Units: Dots

| Signal | Resolution | Aspect mode | | | | | |
|--|-------------------------|-------------|----------|----------|----------|-----------------|----------|
| | | Normal | Squeeze | Zoom | Through | Squeeze through | Wide |
| VGA 60 | 640×480 640×360 *2 | 960×720 | 1280×720 | 1280×720 | 640×480 | 853×480 | 1280×720 |
| VESA72/75/ 85, iMac *1 | 640×480 640×360 *2 | 960×720 | 1280×720 | 1280×720 | 640×480 | 853×480 | 1280×720 |
| SVGA 56/60/ 72/75/85, iMac *1 | 800×600 800×450 *2 | 960×720 | 1280×720 | 1280×720 | 800×600 | 1066×600 | 1280×720 |
| XGA 60/70/ 75/85, iMac *1 | 1024×768 1024×576 *2 | 960×720 | 1280×720 | 1280×720 | - | - | 1280×720 |
| WXGA60-1 | 1280×768 | 1280×720 | 1280×720 | 1280×720 | - | - | - |
| WXGA60-2 | 1360×768 | 1280×720 | 1280×720 | 1280×720 | - | - | - |
| SXGA 60 | 1280×1024 1280×960 | 960×720 | 1280×720 | 1280×720 | - | - | 1280×720 |
| MAC13" | 640×480 | 960×720 | 1280×720 | 1280×720 | 640×480 | 853×480 | 1280×720 |
| MAC16" | 832×624 | 960×720 | 1280×720 | 1280×720 | 832×624 | 1109×624 | 1280×720 |
| MAC19" | 1024×768 | 960×720 | 1280×720 | 1280×720 | - | - | 1280×720 |
| SDTV (525i, 60Hz) | 720×480 720×360 *2 | 960×720 | 1280×720 | 1280×720 | 640×480 | 853×480 | 1280×720 |
| SDTV(525p) | 720×480 720×360 *2 | 960×720 | 1280×720 | 1280×720 | 640×480 | 853×480 | 1280×720 |
| SDTV(625i, 50Hz) | 720×576 720×432 *2 | 960×720 | 1280×720 | 1280×720 | 768×576 | 1024×576 | 1280×720 |
| SDTV(625p) | 720×576 720×432 *2 | 960×720 | 1280×720 | 1280×720 | 768×576 | 1024×576 | 1280×720 |
| HDTV (750p) | 1280×720 | 1280×720 | - | - | 1280×720 | - | - |
| HDTV(1125i) | 1920×1080 | 1280×720 | - | - | - | - | - |

*1 Connection is not possible if the equipment does not have a VGA output port.

*2 Letterbox signal

■ correspond to input signals from the [HDMI] input port.

It may be possible to project signals which are not listed in the above table. However, some functions may be limited in that case.

Specifications

| | | | |
|------------------------------|---|------------------------------|---------------------------------|
| Product name | Home Projector EMP-TW700 | | |
| Dimensions | 406 (W) × 124 (H) × 310 (D) mm (not including feet) | | |
| Panel size | 0.7 inch wide | | |
| Display method | Polysilicon TFT active matrix | | |
| Resolution | 921,600 pixels (1280 (W) × 720 (H) dots) × 3 | | |
| Scanning frequencies | Analogue | Pixel clock : 13.5 - 110 MHz | |
| | | Horizontal : 15 - 92 kHz | |
| | | Vertical : 50 - 85 Hz | |
| | Digital | Pixel clock : 13.5 - 81 MHz | |
| | | Horizontal : 15 - 60 kHz | |
| | | Vertical : 50 - 85 Hz | |
| Focus adjustment | Manual | | |
| Zoom adjustment | Manual (approx. 1 : 2.1) | | |
| Lens shift | Manual (Maximums: Approx. 102% vertically, 50% horizontally) | | |
| Lamp (light source) | UHE lamp, 170 W, Model No.: ELPLP39 | | |
| Power supply | 100- 240VAC 50/60Hz 2.7-1.2A Power Consumption Operating: 245W(100-120V area), 240W(200-240V area) Standby: 4.0W(100-120V area), 5.0W(200-240V area) | | |
| Operating altitude | 0 – 2286m (0 – 7500ft.) | | |
| Operating temperature | +5 – +35°C (No condensation) | | |
| Storage temperature | -10 – +60°C (No condensation) | | |
| Weight | Approx. 5.4kg | | |
| Ports | SCART input | 1 | D + RCA pin jack |
| | Component input | 1 | RCA pin jack × 3 |
| | PC input | 1 | Mini D-sub 15-pin (female) blue |
| | <u>HDMI</u> ™ input | 1 | HDMI |
| | Video input | 1 | RCA pin jack |
| | S-Video input | 1 | Mini DIN 4-pin |
| | RS-232C | 1 | D-sub 9-pin (male) |
| | Trigger out | 1 | 3.5 mm mini jack |



Pixelworks DNX™ ICs are used in this Projector.

■ Angle of tilt

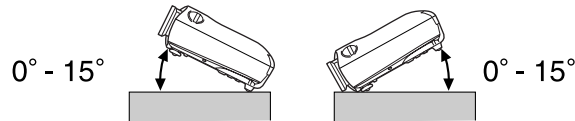

If you set the projector higher than 15°, it could damage the projector and cause an accident.

■ RS-232C cable layout

- Connector shape : D-Sub 9-pin (male)
- Projector input connector : RS-232C

<At projector>

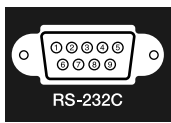

<At computer>

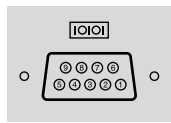

<At projector> (PC serial cable) <At computer>

| | | | | |
|-----|---|-------|---|-----|
| GND | 5 | ————— | 5 | GND |
| RD | 2 | ←———— | 3 | TD |
| TD | 3 | ————→ | 2 | RD |
| DTR | 4 | ————→ | 6 | DSR |
| DSR | 6 | ←———— | 4 | DTR |

| Signal | Function |
|--------|---------------------|
| GND | Signal wire earth |
| TD | Transmit data |
| RD | Receive data |
| DSR | Data set ready |
| DTR | Data terminal ready |

Safety

USA
UL60950-1

Canada
CSA C22.2 No.60950-1

EU
The Low Voltage Directive
(73/23/EEC)
IEC/EN60950-1

EMC

USA
FCC Part 15B Class B (DoC)

Canada
ICES-003 Class B

EU
The EMC Directive
(89/336/EEC)
EN55022 Class B
EN55024
IEC/EN61000-3-2
IEC/EN61000-3-3

Australia/New Zealand
AS/NZS CISPR 22:2002 Class B

DECLARATION of CONFORMITY

According to 47CFR, Part 2 and 15
Class B Personal Computers and Peripherals; and/or
CPU Boards and Power Supplies used with Class B
Personal Computers

We : EPSON AMERICA, INC.
Located at : 3840 Kilroy Airport Way
MS: 313
Long Beach, CA 90806
Tel : 562-290-5254

Declare under sole responsibility that the product identified herein, complies with 47CFR Part 2 and 15 of the FCC rules as a Class B digital device. Each product marketed, is identical to the representative unit tested and found to be compliant with the standards. Records maintained continue to reflect the equipment being produced can be expected to be within the variation accepted, due to quantity production and testing on a statistical basis as required by 47CFR 2.909. Operation is subject to the following two conditions : (1) this device may not cause harmful interference, and (2) this device must accept any interference received, including interference that may cause undesired operation.

Trade Name : EPSON
Type of Product : Projector
Model : EMP-TW700

**FCC Compliance Statement
For United States Users**

This equipment has been tested and found to comply with the limits for a Class B digital device, pursuant to Part 15 of the FCC Rules. These limits are designed to provide reasonable protection against harmful interference in a residential installation. This equipment generates, uses, and can radiate radio frequency energy and, if not installed and used in accordance with the instructions, may cause harmful interference to radio or television reception. However, there is no guarantee that interference will not occur in a particular installation. If this equipment does cause interference to radio and television reception, which can be determined by turning the equipment off and on, the user is encouraged to try to correct the interference by one or more of the following measures.

- Reorient or relocate the receiving antenna.
- Increase the separation between the equipment and receiver.
- Connect the equipment into an outlet on a circuit different from that to which the receiver is connected.
- Consult the dealer or an experienced radio/TV technician for help.

WARNING

The connection of a non-shielded equipment interface cable to this equipment will invalidate the FCC Certification or Declaration of this device and may cause interference levels which exceed the limits established by the FCC for this equipment. It is the responsibility of the user to obtain and use a shielded equipment interface cable with this device. If this equipment has more than one interface connector, do not leave cables connected to unused interfaces. Changes or modifications not expressly approved by the manufacturer could void the user's authority to operate the equipment.

Following is an explanation of some of the terms used in this guide which may be unfamiliar or which were not explained in the manual itself. Further information can be obtained by referring to other commercially-available publications.

Aspect

The ratio between an image's length and its height. **HDTV** images have an aspect of 16:9 and appear elongated. The aspect for standard images is 4:3.

Component video

Video signals which have the video brightness signals and color signals separated, in order to provide better image quality.

In high-definition TV (HDTV), it refers to images which consist of three independent signals: Y (luminance signal), and Pb and Pr (color difference signals).

Composite video

Video signals which have the video brightness signals and color signals mixed together. The type of signals commonly used by household video equipment (**NTSC**, **PAL** and **SECAM** formats).

Video signals which consist of a carrier signal Y (luminance signal) within the color bar signal, and a chroma or color signal (CbCr).

Contrast

The relative brightness of the light and dark areas of an image can be increased or decreased in order to make text and graphics stand out more clearly, or to make them appear softer.

Cool-down

This is the process by which the projector's lamp is cooled down after it has become hot through use. It is carried out automatically when the [Power] button on either the remote control or the projector's control panel has been pressed to turn off the projector. Do not turn off the main power switch while cool-down is in progress, otherwise the cool-down process will not work properly. If the cool-down period is not allowed to finish normally, the projector's lamp and internal components will remain at high temperatures, and this may shorten the useful life of the lamp or cause problems with the operation of the projector. The projector takes about 30 seconds to cool down. The actual time will vary depending on the external air temperature.

HDMI

An abbreviation for High Definition Multimedia Interface, and refers to a standard for digital transmission of high-definition images and multi-channel audio signals.

HDMI is a standard that is targeted towards household digital equipment and computers that allows digital signals to be transmitted in their original high quality without compression, and it also includes a digital signal encryption function.

HDTV

An abbreviation for High-Definition Television. It refers to high-definition systems which satisfy the following conditions.

- Vertical resolution of 750p or 1125i or greater (p = **progressive**, i = **interlaced**)
- Screen **aspect** of 16:9
- Dolby **Digital** audio reception and playback (or output)

Interlace

A method of image scanning whereby the signal bandwidth used is approximately half that required for sequential scanning when images with the same still picture resolution are broadcast.

NTSC

An abbreviation for National Television Standards Committee, and a format for ground-based analogue colour television broadcasts. This format is used in Japan, North America and Central and South America.

PAL

An abbreviation for Phase Alternation by Line, and a format for ground-based analogue colour television broadcasts. This format is used in Western European countries except France, and also in Asian countries such as China and in Africa.

Progressive

A method of image scanning whereby the image data from a single image is scanned sequentially from top to bottom to create a single image.

Refresh rate

The light-emitting element of a display maintains the same luminosity and color for an extremely short time. Because of this, the image must be scanned many times per second in order to refresh the light emitting element. The number of refresh operations per second is called the "refresh rate", and is expressed in hertz (Hz).

S-Video

A video signal which has the luminance component and color component separated in order to provide better image quality.

It refers to images which consist of two independent signals: Y (luminance signal), and C (color signal).

SDTV

An abbreviation for Standard Definition Television. It refers to standard television systems which do not satisfy the conditions for HDTV.

SECAM

An abbreviation for Sequential Couleur A Memoire, and a format for ground-based analogue colour television broadcasts. This format is used in France, Eastern Europe and the former Soviet Union, the Middle East and Africa.

Security lock

A device consisting of a protector case with a hole in it that a commercially-available theft-prevention cable can be passed through in order to secure the device to a table or pillar. This projector is compatible with the Microsaver Security System manufactured by Kensington.

sRGB

An international standard for color intervals that was formulated so that colors which are reproduced by video equipment can be handled easily by computer operating systems (OS) and the Internet.

SVGA

A type of image signal with a resolution of 800 (horizontal) x 600 (vertical) dots which is used by IBM PC/ AT-compatible computers.

SXGA

A type of image signal with a resolution of 1280 (horizontal) x 1024 (vertical) dots which is used by IBM PC/ AT-compatible computers.

Sync. (Synchronization)

The signals output from computers have a specific frequency. If the projector frequency does not match this frequency, the resulting images will not be of a good quality. The process of matching the phases of these signals (the relative position of the crests and troughs in the signal) is called "synchronization". If the signals are not synchronized, problems such as flickering, blurriness and horizontal interference can occur.

Tracking

The signals output from computers have a specific frequency. If the projector frequency does not match this frequency, the resulting images will not be of a good quality. The process of matching the frequency of these signals (the number of crests in the signal) is called "tracking". If tracking is not carried out correctly, wide vertical stripes will appear in the projected images.

VGA

A type of image signal with a resolution of 640 (horizontal) x 480 (vertical) dots which is used by IBM PC/ AT-compatible computers.

XGA

A type of image signal with a resolution of 1,024 (horizontal) x 768 (vertical) dots which is used by IBM PC/ AT-compatible computers.

YCbCr

The carrier signal which is contained in the color bar signal used in modern TV transmissions. The name comes from the Y (luminance) signal and the CbCr (chroma [color]) signals.

YPbPr

The carrier signal which is contained in the color bar signal used in high-definition TV (**HDTV**) transmissions. The name comes from the Y (luminance) signal and the PbPr (color difference) signals.

A

| | |
|-------------------------------------|---------------|
| Absolute Color Temperature | 20,26,28 |
| Advanced | 27,30 |
| Air filter | 8 |
| Aspect | 7,18,27,29,47 |
| Auto | 18 |
| Auto Iris | 23,26,29 |
| Automatic adjustment function | 14 |
| Auto Setup | 24,27,31 |

B

| | |
|---|-------|
| Battery replacement period (Remote control) | 13 |
| Black Level | 26,28 |
| Brightness | 26,28 |

C

| | |
|--------------------------------------|------------|
| Ceiling | 11,27,33 |
| Child Lock | 27,31 |
| Cinema Filter | 21 |
| Cleaning the air filter | 42 |
| Cleaning the lens | 42 |
| Cleaning the projector case | 42 |
| Color Adjustment | 20,26,28 |
| Color Mode | 7,18,26,28 |
| Color Saturation | 26,28 |
| [Component] port | 8,12,15,49 |
| Component Video | 12,47 |
| Composite Video | 12,47 |
| Configuration menu | 26 |
| Connecting to a computer | 12 |
| Connecting to a video source | 12 |
| Consumables | 46 |
| Contrast | 7,26,28 |
| Control panel | 6 |
| Cool-down | 15,36 |
| Correcting keystone distortion | 6,17 |
| Correcting projector tilt | 17 |

D

| | |
|--------------------------|-------|
| Direct Power On | 27,31 |
| Display | 27,32 |
| Display Background | 27,32 |
| DVI-Video Level | 27,30 |

E

| | |
|---------------------------|-------|
| Epson Cinema Filter | 21 |
| EPSON Super White | 27,30 |

F

| | |
|-----------------------------|-------|
| Focus adjustment | 6,16 |
| Front adjustable foot | 6,17 |
| Full Menu | 26,34 |

G

| | |
|-------------|----------|
| Gain | 22,29 |
| Gamma | 20,26,29 |

H

| | |
|--------------------------|------------|
| HDTV | 47 |
| [HDMI] input port | 8,12,48,49 |
| High Altitude Mode | 27,32 |
| Hue and saturation | 22 |

I

| | |
|------------------------|-------|
| Image size | 10 |
| "Image" menu | 27,29 |
| Indicators | 6,35 |
| "Info" menu | 27 |
| Input Adjustment | 26,28 |
| Input Signal | 27,33 |

K

| | |
|----------------|------------|
| Keystone | 6,17,27,31 |
|----------------|------------|

L

| | |
|-------------------|----------|
| Lamp cover | 8,44 |
| Lamp Hours | 27 |
| Language | 27,33 |
| Lens cover | 6,14 |
| Lens shift | 6,16 |
| Line menu | 26,34 |
| Load Memory | 24,27,33 |

M

| | |
|-------------------------|---------|
| Main power switch | 8,14,15 |
| Memory | 7,24 |
| "Memory" Menu | 27,33 |
| Menu Color | 27,32 |
| Menu Position | 27,32 |
| Menus | 26 |
| Message | 27,32 |

N

| | |
|----------------------|-------|
| Navigation Bar | 27,32 |
| Normal | 19 |

O

| | |
|----------------------------|-------|
| Offset | 22,29 |
| Operation | 27,31 |
| Operation indicator | 6,35 |
| Operation Lock | 27,31 |
| Optional accessories | 46 |
| Output Scaling | 27,30 |
| Overheating | 35 |

P

| | |
|--|----------|
| [PC] port | 8,12,49 |
| "Picture" menu | 26,28 |
| Port | 8,12,49 |
| Position | 27,30 |
| Power cable | 14 |
| Power inlet | 8,14 |
| Progressive | 27,30 |
| Projection | 11,27,33 |
| Projection distance | 10 |
| Projection image position adjustment | 16 |
| Projection methods | 11 |

- R**
- Refresh Rate 27
 - Remote control 7,13
 - Replacing the air filter 44
 - Replacing the battery 13
 - Replacing the lamp 44
 - Reset 26,27,29,31,33
 - Reset All 27,34
 - "Reset" menu 27,34
 - Reset Lamp Hours 27,34,44
 - Reset Memory 27,33
 - Resolution 27,47
 - RGB 22,26,29
 - RGBCMY 22,26,29
 - [RS-232C] port 8,49,50
- S**
- Save Memory 24,27,33
 - SCART 1,27,33
 - [SCART] input port 8,12,49
 - Screen size 10
 - SDTV 47
 - Selecting the image source 6,7,15
 - Setup Level 27,30
 - "Settings" menu 27,31
 - Sharpness 26,28
 - Sharpness (Advanced) 23,26,28
 - Skin Tone 7,20,26,29
 - Sleep Mode 27,31
 - Source 27
 - Specifications 49
 - Squeeze 19
 - Squeeze Through 19
 - sRGB 19,26
 - Startup Screen 27,32
 - Sub-menu 26
 - Supported Monitor Displays 47
 - S-Video 12,47
 - [S-Video] input port 8,12,49
 - Sync Info 27
 - Sync 27,29
- T**
- Test Pattern 7,17
 - Through 19
 - Tint 26,28
 - Top menu 26
 - Tracking 27,29
 - Trigger Out 27,31
 - [Trigger out] port 8,49
 - Turning off 15
- U**
- Using the configuration menus 34
 - User's Logo 27,32
- V**
- Vertical Size 27,29
 - [Video] input port 8,12,49
 - Video Signal 27,33
- W**
- Warning indicator 6,35
 - White Level 26,28
 - Wide 19
- Y**
- YCbCr 12,27
 - YPbPr 12,27
- Z**
- Zoom 19
 - Zoom adjustment 6,16
 - Zoom Caption 19,27,29
 - Zoom Position 27,29

All rights reserved. No part of this publication may be reproduced, stored in a retrieval system, or transmitted in any form or by any means, electronic, mechanical, photocopying, recording, or otherwise, without the prior written permission of SEIKO EPSON CORPORATION. No patent liability is assumed with respect to the use of the information contained herein. Neither is any liability assumed for damages resulting from the use of the information contained herein.

Neither SEIKO EPSON CORPORATION nor its affiliates shall be liable to the purchaser of this product or third parties for damages, losses, costs, or expenses incurred by purchaser or third parties as a result of: accident, misuse, or abuse of this product or unauthorised modifications, repairs, or alterations to this product, or (excluding the U.S.) failure to strictly comply with SEIKO EPSON CORPORATION's operating and maintenance instructions.

SEIKO EPSON CORPORATION shall not be liable against any damages or problems arising from the use of any options or any consumable products other than those designated as Original EPSON Products or EPSON Approved Products by SEIKO EPSON CORPORATION.

The contents of this guide may be changed or updated without further notice.

Illustrations and screens used in this publication may differ from actual illustrations and screens.

General Notice:

Macintosh, Mac, and iMac are registered trademarks of Apple Computer, Inc.

IBM is a registered trademark of International Business Machines Corporation.

Windows, WindowsNT and VGA are trademarks or registered trademarks of Microsoft Corporation in the United States.

Dolby is a trademark of Dolby Laboratories.

HDMI and High-Definition Multimedia Interface are trademarks or registered trademarks of HDMI Licensing LLC.

Pixelworks and DNX are trademarks of Pixelworks, Inc.

Other product names used herein are also for identification purposes only and may be trademarks of their respective owners. EPSON disclaims any and all rights in those marks.

EPSON

E



Printed on 100% recycled paper.



Printed in China
410668700
06.XX-.XA(G04)