

LX501/LW401/LWU421/ LX601i/LW551i/LWU501i

Setup Guide

020-000504-02

LX501/LW401/LWU421/ LX601i/LW551i/LWU501i

Setup Guide **User's Manual (concise)**

Thank you for purchasing this projector.

Please read through this manual before using this product, in order to use safely and utilize well the product.

- ⚠ WARNING** ▶ Before using this product, be sure to read all manuals for this product. After reading them, store them in a safe place for future reference.
- ▶ Heed all the warnings and cautions in the manuals or on the product.
 - ▶ Follow all the instructions in the manuals or on the product.

NOTE • In this manual, unless any comments are accompanied, “the manuals” means all the documents provided with this product, and “the product” means this projector and all the accessories came with the projector.

Contents

First of all..... 2	Connecting power supply 9
Entries and graphical symbols explanation 2	Turning on the power..... 10
Important safety instruction 2	Adjusting the projector's elevator 11
Regulatory notices..... 3	Adjusting the lens position..... 11
About Electro-Magnetic Interference 3	Displaying the picture 12
About Waste Electrical and Electronic Equipment... 4	Turning off the power 13
Contents of package..... 4	Replacing the lamp..... 14
Preparing for the remote control..... 5	Cleaning and replacing the air filter .. 16
Arrangement..... 6	Using the CD manual 18
Connecting with your devices..... 7	Specifications 19
Fastening the adapter cover..... 8	Troubleshooting
Fastening the cable holder 8	- Warranty and after-service 21

First of all

Entries and graphical symbols explanation

The following entries and graphical symbols are used for the manuals and the product as follows, for safety purpose. Please know their meanings beforehand, and heed them.

- ⚠ **WARNING** This entry warns of a risk of serious personal injury or even death.
- ⚠ **CAUTION** This entry warns of a risk of personal injury or physical damage.
- NOTICE** This entry notices of fear of causing trouble.

Important safety instruction

The followings are important instructions for safely using the product. Be sure to follow them always when handling the product. The manufacturer assumes no responsibility for any damage caused by mishandling that is beyond normal usage defined in these manuals of this projector.

- ⚠ **WARNING** ▶ Never use the product in or after an abnormality (ex. giving off smoke, smelling strange, took a liquid or an object inside, broken, etc.) If an abnormality should occur, unplug the projector urgently.
 - ▶ Situate the product away from children and pets.
 - ▶ Keep small parts away from children and pets. If swallowed, consult a physician immediately for emergency treatment.
 - ▶ Do not use the product when there is fear of a thunderbolt.
 - ▶ Unplug the projector from the power outlet if the projector is not used for the time being.
 - ▶ Do not connect the projector to a power supply while no lens unit is attached to it.
 - ▶ Do not open or remove any portion of the product, unless the manuals direct it. For internal maintenance, leave it to your dealer or their service personnel.
 - ▶ Use only the accessories specified or recommended by the manufacturer.
 - ▶ Do not modify the projector or accessories.
 - ▶ Do not let any things or any liquids enter to the inside of the product.
 - ▶ Do not wet the product.
 - ▶ Do not place the projector where any oils, such as cooking or machine oil, are used. Oil may harm the product, resulting in malfunction, or falling from the mounted position.
 - ▶ Do not apply a shock or pressure to this product.
- Do not place the product on an unstable place such as the uneven surface or the leaned table.
- Do not place the product unstably. Place the projector so that it does not protrude from the surface where the projector is placed on.
- Place your hands on the grip on the bottom of the projector when carrying the projector.
- Remove all the attachments including the power cord and cables, from the projector when carrying the projector.
 - ▶ Do not look into the lens and the openings on the projector, while the lamp is on.
 - ▶ Do not approach the lamp cover and the exhaust vents, while the projection lamp is on. Also after the lamp goes out, do not approach them for a while, since too hot.

<http://www.pureglare.com.au>

About Electro-Magnetic Interference

This is a Class A product. In a domestic environment this product may cause radio interference in which case the user may be required to take adequate measures.

This product may cause interference if used in residential areas. Such use must be avoided unless the user takes special measures to reduce electromagnetic emissions to prevent interference to the reception of radio and television broadcasts.

In Canada

This Class A digital apparatus complies with Canadian ICES-003.

In the US and places where the FCC regulations are applicable

This device complies with part 15 of the FCC Rules. Operation is subject to the following two conditions: (1) This device may not cause harmful interference, and (2) this device must accept any interference received, including interference that may cause undesired operation. This equipment has been tested and found to comply with the limits for a Class A digital device, pursuant to Part 15 of the FCC Rules.

These limits are designed to provide reasonable protection against harmful interference when the equipment is operated in a commercial environment. This equipment generates, uses, and can radiate radio frequency energy and, if not installed and used in accordance with the instruction manual, may cause harmful interference to radio communications. Operation of this equipment in a residential area is likely to cause harmful interference in which case the user will be required to correct the interference at his own expense.

INSTRUCTIONS TO USERS: Some cables have to be used with the core set. Use the accessory cable or a designated type cable for the connection. For cables that have a core only at one end, connect the core to the projector.

CAUTION: Changes or modifications not expressly approved by the party responsible for compliance could void the user's authority to operate the equipment.

Regulatory notices (continued)

About Waste Electrical and Electronic Equipment



The mark is in compliance with the Waste Electrical and Electronic Equipment Directive 2002/96/EC (WEEE).

The mark indicates the requirement NOT to dispose the equipment including any spent or discarded batteries or accumulators as unsorted municipal waste, but use the return and collection systems available. If the batteries or accumulators included with this equipment, display the chemical symbol Hg, Cd, or Pb, then it means that the battery has a heavy metal content of more than 0.0005% Mercury or more than, 0.002% Cadmium, or more than 0.004% Lead.

Contents of package

Your projector should come with the items shown below. Check that all the items are included. Require of your dealer immediately if any items are missing.

- (1) Remote control with two AA batteries
- (2) Power cord
- (3) Computer cable
- (4) HDMI™-DVI cable
- (5) Lens cover
- (6) User's manuals (Book x1, CD x1)
- (7) Security label
- (8) Application CD
- (9) Adapter cover
- (10) Cable holder

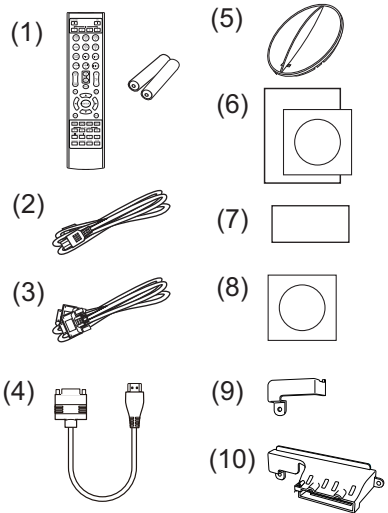

⚠ WARNING ► Keep small parts away from children and pets. Take care not to put in the mouth. If swallowed, consult a physician immediately for emergency treatment.

NOTICE ► It is recommended that the adapter cover or the cable holder is used with the USB wireless adapter (optional) to prevent the adapter from becoming detached and to avoid the risk of burns.

NOTE • Keep the original packing materials for future reshipment. Be sure to use the original packing materials when moving the projector. Use special caution for the lens.

• The projector may make a rattling sound when tilted, moved or shaken, since a flap to control the air flow inside of the projector has moved. Be aware that this is not a failure or malfunction.

<http://www.pureglare.com.au>

Preparing for remote control

Please insert the batteries into the remote control before using it. If the remote control starts to malfunction, try to replace the batteries. If you will not use the remote control for long period, remove the batteries from the remote control and store them in a safe place.

1. Holding the hook part of the battery cover, remove it.

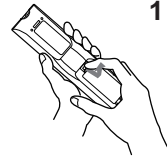

2. Align and insert the two AA batteries (**HITACHI MAXELL** or **HITACHI MAXELL ENERGY, Part No.LR6 or R6P**) according to their plus and minus terminals as indicated in the remote control.

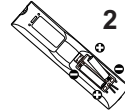

3. Replace the battery cover in the direction of the arrow and snap it back into place.

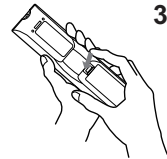

- ⚠ WARNING** ► Always handle the batteries with care and use them only as directed. Improper use may result in battery explosion, cracking or leakage, which could result in fire, injury and/or pollution of the surrounding environment.
- When replacing the batteries, replace both of the batteries with new batteries of the same type. Do not use a new battery with a used battery.
 - Be sure to use only the batteries specified. Do not use batteries of different types at the same time. Do not mix a new battery with used one.
 - Make sure the plus and minus terminals are correctly aligned when loading a battery.
 - Keep a battery away from children and pets.
 - Do not recharge, short circuit, solder or disassemble a battery.
 - Do not place a battery in a fire or water. Keep batteries in a dark, cool and dry place.
 - If you observe battery leakage, wipe out the leakage and then replace a battery. If the leakage adheres to your body or clothes, rinse well with water immediately.
 - Obey the local laws on disposing the battery.

Arrangement

Refer to tables **T-1** to **T-5** at the back of this manual as well as the following to determine the screen size and projection distance. The values shown in the table are calculated for a full size screen.

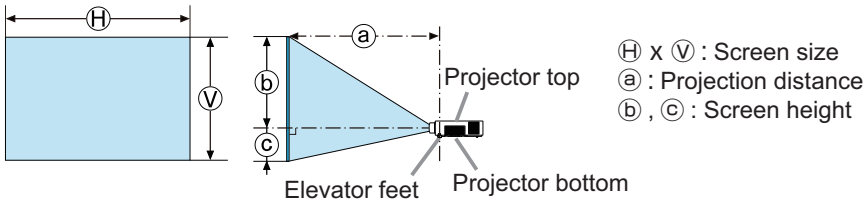

⚠ WARNING ▶ Install the projector where you can access the power outlet easily.

▶ Install the projector in a stable horizontal position.

- Do not use any mounting accessories except the accessories specified by the manufacturer. Read and keep the manuals of the accessories used.
- For special installation such as ceiling mounting, be sure to consult your dealer beforehand. Specific mounting accessories and services may be required.
- Do not put the projector on its side, front or rear position.
- Do not attach nor place anything on the projector unless otherwise specified in the manual.

▶ Do not install the projector near thermally conductive or flammable things.

▶ Do not place the projector where any oils, such as cooking or machine oil, are used.

▶ Do not place the projector in a place where it may get wet.

⚠ CAUTION ▶ Place the projector in a cool place with sufficient ventilation.

- Keep a space of 30 cm or more between a side of the projector and other objects such as walls.
- Do not stop up, block nor cover the projector's vent holes.
- Do not place the projector at places that are exposed to magnetic fields, doing so can cause the cooling fans inside the projector to malfunction.
- ▶ Avoid placing the projector in smoky, humid or dusty place.
- Do not place the projector near humidifiers.

NOTICE ▶ Position the projector to prevent light from directly hitting the projector's remote sensor.

▶ Do not place the product in a place where radio interference may be caused.

▶ Set the ALTITUDE of the SERVICE item in the OPTION menu correctly. It is recommended to leave it at AUTO usually. If the projector is used with a wrong setting, it may cause damage to the projector itself or the parts inside. For details, see **User Manual - Operating Guide**.

Connecting with your devices

Before connecting the projector to a device, consult the manual of the device to confirm that the device is suitable for connecting with this projector and prepare the required accessories, such as a cable in accord with the signal of the device. Consult your dealer when the required accessory did not come with the product or the accessory is damaged.

After making sure that the projector and the devices are turned off, perform the connection, according to the following instructions. Refer to figures **F-1** to **F-4** at the back of this manual.

For details, see **User Manual - Operating Guide**. Before connecting the projector to a network system, be sure to read **User Manual - Network Guide** too.

⚠ WARNING ▶ Use only the appropriate accessories. Otherwise it could cause a fire or damage the projector and devices.

- Use only the accessories specified or recommended by the projector's manufacturer. It may be regulated under some standard.
- Neither disassemble nor modify the projector and the accessories.
- Do not use the damaged accessory. Be careful not to damage the accessories. Route a cable so that it is neither stepped on nor pinched out.

⚠ CAUTION ▶ For a cable with a core at only one end, connect the end with the core to the projector. That may be required by EMI regulations.

- ▶ Before connecting the projector to a network system be sure to obtain the consent of the administrator of the network.
- ▶ Do not connect the **LAN** port to any network that might have the excessive voltage.
- ▶ The designated USB wireless adapter that is sold as an option is required to use the wireless network function of this projector.
- ▶ Before removing the USB storage device from the port of the projector, be sure to use the REMOVE USB function on the thumbnail screen to secure your data. Before you insert or pull out the USB wireless adapter from the projector, turn off the power of the projector and pull out the power cord's plug from the outlet. Do not touch the USB wireless adapter while the projector is receiving AC power.

NOTE • Do not turn on or off the projector while connected to a device in operation, unless that is directed in the manual of the device.

- Some input ports are selectable in the use. For details, see **User Manual - Operating Guide**.
- Be careful not to mistakenly connect a connector to a wrong port.
- If an oversized USB storage device blocks the **LAN** port, use a USB extension cable to connect the USB storage device.

Fastening the adapter cover

Use the supplied adapter cover to prevent the USB wireless adapter from coming off easily. When using the adapter cover, connect the USB wireless adapter to the further **USB TYPE A** port from the **LAN** port.

1. Loosen the screw marked with a triangle.
2. Insert the tab of the cover into the hole at the upper right of the **USB TYPE A** ports in the direction of the arrow.
3. Align the screw holes on the projector and the cover. Then insert the screw removed from the projector into the hole and tighten the screw.

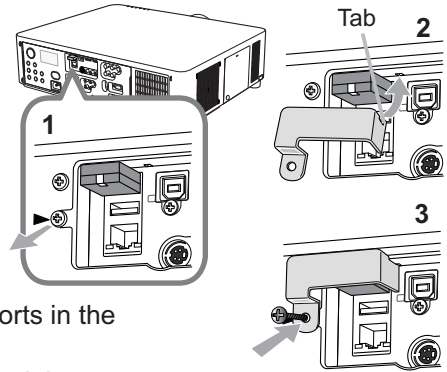

⚠ WARNING ► Keep small parts away from children and pets. Take care not to put in the mouth.

Fastening the cable holder

Use the supplied cable holder to prevent the USB wireless adapter and the HDMI™ cables from becoming detached. When using the cable holder, connect the USB wireless adapter to the further **USB TYPE A** port from the **LAN** port.

1. Remove the screw marked with a triangle and the screw marked with a diamond.
2. Open the cable holder clip and then align the screw holes on the projector and the holder. Then insert the screw removed from the projector into the hole and tighten the screw.
3. Snap the clip closed to secure the HDMI™ cables in place.

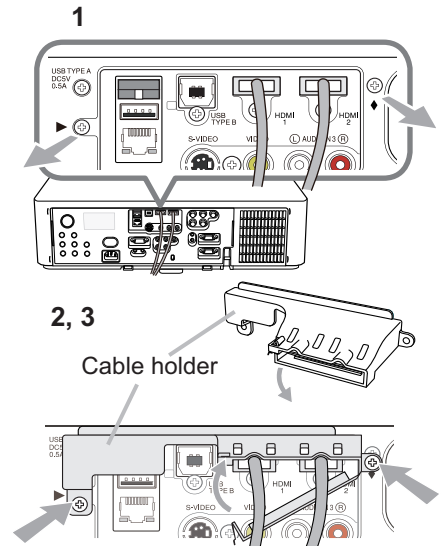

⚠ WARNING ► Keep small parts away from children and pets. Take care not to put in the mouth.

Connecting power supply

1. Put the connector of the power cord into the **AC IN** (AC inlet) of the projector.
2. Firmly plug the power cord's plug into the outlet. In a couple of seconds after the power supply connection, the **POWER** indicator will light up in steady orange.

Please remember that when the **DIRECT POWER ON** function activated, the connection of the power supply make the projector turn on.

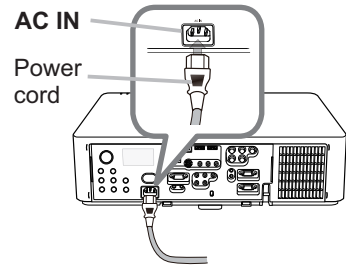

⚠ WARNING ► Do not connect the projector to a power supply while no lens unit is attached to it.

► Please use extra caution when connecting the power cord, as incorrect or faulty connections may result in fire and/or electrical shock.

- Do not touch the power cord with a wet hand.
- Only use the power cord that came with the projector. If it is damaged, consult your dealer to get a new one. Never modify the power cord.
- Only plug the power cord into an outlet whose voltage is matched to the power cord. The power outlet should be close to the projector and easily accessible. Remove the power cord for complete separation.
- Do not distribute the power supply to multiple devices. Doing so may overload the outlet and connectors, loosen the connection, or result in fire, electric shock or other accidents.
- Connect the ground terminal for the AC inlet of this unit to the ground terminal of the building using an appropriate power cord (bundled).

NOTICE ► This product is also designed for IT power systems with a phase-to-phase voltage of 220 to 240 V.

Turning on the power

1. Make sure that the power cord is firmly and correctly connected to the projector and the outlet.
2. Make sure that the **POWER** indicator is lighted in steady orange. Then remove the lens cover.
3. Press the **STANDBY/ON** button on the projector or the **ON** button on the remote control.

The projection lamp will light up and the **POWER** indicator will begin blinking in green. When the power is completely on, the indicator will stop blinking and light in steady green.

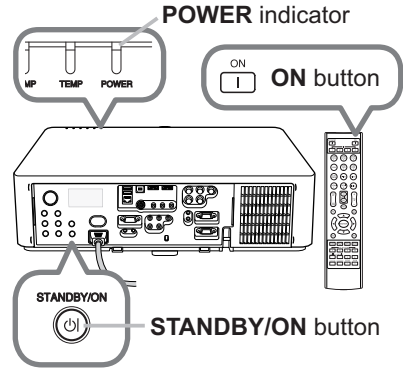

⚠ WARNING ► A strong light is emitted when the projector's power is on. Do not look into the lens of the projector or look inside of the projector through any of the projector's openings.

NOTE • Please power on the projector prior to the connected devices.
 • The projector has the DIRECT POWER ON function, which can make the projector automatically turn on. For more information, please see **User Manual - Operating Guide**.

Adjusting the projector's elevator

When the place to put the projector is slightly uneven to the left or right, use the elevator feet to place the projector horizontally. Using the feet can also tilt the projector in order to project at a suitable angle to the screen, elevating the front side of the projector within 9 degrees. This projector has 2 elevator feet and 2 elevator buttons. An elevator foot is adjustable while pushing the elevator button on the same side as it.

1. Holding the projector, push the elevator buttons to loose the elevator feet.
2. Position the front side of the projector to the desired height.
3. Release the elevator buttons in order to lock the elevator feet.
4. After making sure that the elevator feet are locked, put the projector down gently.
5. If necessary, the elevator feet can be manually twisted to make more precise adjustments. Hold the projector when twisting the feet.

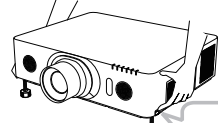
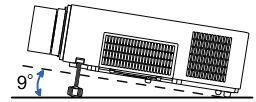

To loose an elevator foot, push the elevator button on the same side as it.

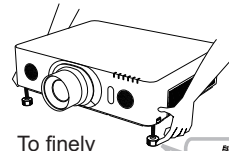
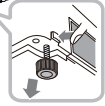

To finely adjust, twist the foot.



CAUTION ▶ Do not handle the elevator buttons without holding the projector, since the projector may drop down.
 ▶ Do not tilt the projector other than elevating its front within 9 degrees using the adjuster feet. A tilt of the projector exceeding the restriction could cause malfunction or shortening the lifetime of consumables, or the projector itself. Only for **LX601i**, **LW551i** and **LWU501i**, it is possible to install the projector for any direction with specified mounting accessories.

Adjusting the lens position

Shifting the lens position shifts the projection position.

After pressing the **LENS SHIFT** button on the control panel or the remote control, use the cursor buttons to shift the lens position.

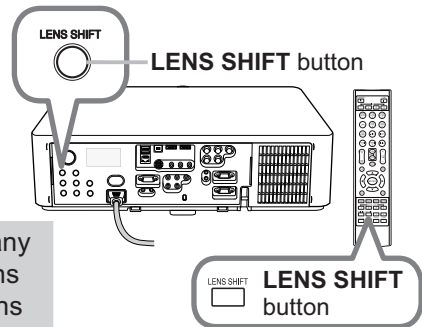

CAUTION ▶ Do not put your fingers or any other things around the lens. The moving lens could catch them in the space around the lens and result in an injury.

NOTE • The projector may ignore operation by buttons while moving the lens.
 • Generally, better image quality can be got when the lens is set to the center.

Displaying the picture

1. Activate your signal source. Turn the signal source on, and make it send the signal to the projector.
2. Use the **VOL + / -** buttons to adjust the volume.
3. Press the **INPUT** button on the projector. Each time you press the button, the projector switches its input port in turn. You can also use the remote control to select an input signal. Press any of the buttons from **COMPUTER 1 / 2**, **LAN**, **USB TYPE A / B**, **HDMI 1 / 2**, **COMPONENT**, **S-VIDEO** or **VIDEO** to select the input signal from each port.
4. Press the **ASPECT** button on the remote control. Each time you press the button, the projector switches the mode for aspect ratio in turn.
5. Use the **ZOOM + / -** buttons on the remote control or **ZOOM** button and **◀/▶** cursor buttons on the projector to adjust the screen size.
6. Use the **FOCUS + / -** buttons on the projector or the remote control to focus the picture.

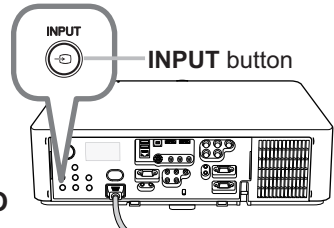
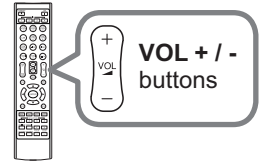

Buttons for input ports

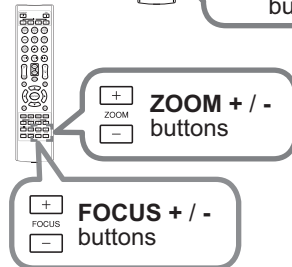
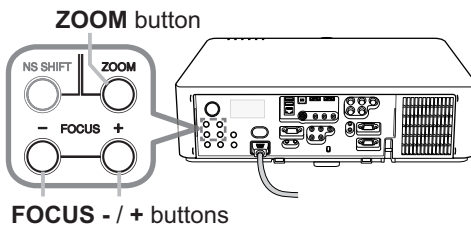
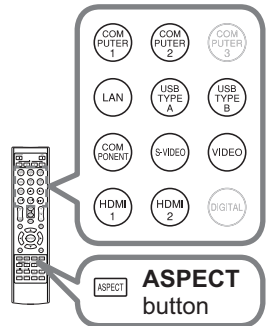

⚠ CAUTION ▶ If you wish to have a blank screen while the projector's lamp is on, use the lens shutter or AV MUTE function (see **User Manual - Operating Guide**). Taking any other action may cause the damage on the projector.

NOTE • The **ASPECT** button does not work when no proper signal is inputted.
• For the details of how to adjust the picture, please see **User Manual - Operating Guide**.

Turning off the power

1. Press the **STANDBY/ON** button on the projector or the **STANDBY** button on the remote control.

The message "Power off?" will appear on the screen for about 5 seconds.

2. Press the **STANDBY/ON** or **STANDBY** button again while the message appears.

The projector lamp will go off, and the **POWER** indicator will begin blinking in orange. Then the **POWER** indicator will stop blinking and light in steady orange when the lamp cooling is complete.

3. Attach the lens cover, after the **POWER** indicator turns to steady orange.

Do not turn the projector on for about 10 minutes or more after turning it off. Also, do not turn the projector off shortly after turning it on. Such operations might cause the lamp to malfunction or shorten the lifetime of some parts including the lamp.

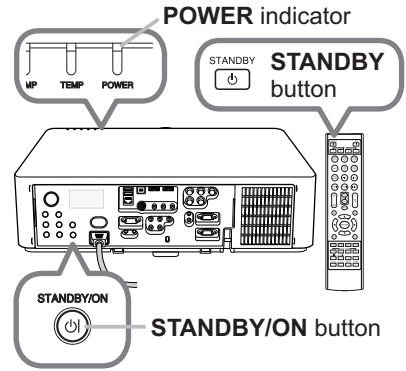

ENGLISH

⚠ WARNING ► Do not touch around the lamp cover and the exhaust vents during use or just after use, since it is too hot.

► Remove the power cord for complete separation. The power outlet should be close to the projector and easily accessible.

NOTE • Please power off the projector after any connected devices are powered off.

• This projector has the AUTO POWER OFF function that can make the projector turn off automatically. For more information, please see **User Manual - Operating Guide**.

Replacing the lamp

A lamp has finite product life. Using the lamp for long periods of time could cause the pictures darker or the color tone poor. Note that each lamp has a different lifetime, and some may burst or burn out soon after you start using them.

Preparation of a new lamp and early replacement are recommended. To prepare a new lamp, make contact with your dealer and tell the lamp type number.

Type number <LX501, LW401, LWU421> : 003-120707-01 (DT01285)

<LX601i, LW551i, LWU501i> : 003-120708-01 (DT01295)

1. Turn the projector off, and unplug the power cord. Allow the projector to cool for at least 45 minutes.
2. Prepare a new lamp. If the projector is mounted with specified mounting accessories, or if the lamp has broken, also ask the dealer to replace the lamp.

In case of replacement by yourself, follow the following procedure.

3. Loosen the screw (marked by arrow) of the lamp cover and then slide down and lift the lamp cover to remove it.

4. Loosen the 3 screws (marked by arrow) of the lamp, and slowly pull the lamp out by the handles.

Never loosen any other screws.

5. Insert the new lamp, and retighten firmly the 3 screws of the lamp that are loosened in the previous process to lock it in place.

6. While putting the interlocking parts of the lamp cover and the projector together, slide the lamp cover back in place. Then firmly fasten the screw of the lamp cover.

7. Turn the projector on and reset the lamp time using the LAMP TIME item in the OPTION menu.

(1) Press the **MENU** button to display a menu.

(2) Point at the **ADVANCED MENU** in the menu using the **▼/▲** button, then press the **▶** button.

(3) Point at the **OPTION** in the left column of the menu using the **▼/▲** button, then press the **▶** button.

(4) Point at the **LAMP TIME** using the **▼/▲** button, then press the **▶** button. A dialog will appear.

(5) Press the **▶** button to select "OK" on the dialog. It performs resetting the lamp time.

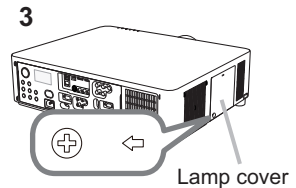

Lamp cover

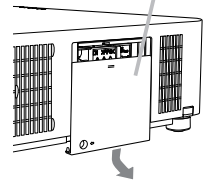

Handles 4, 5

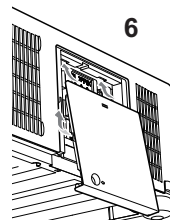
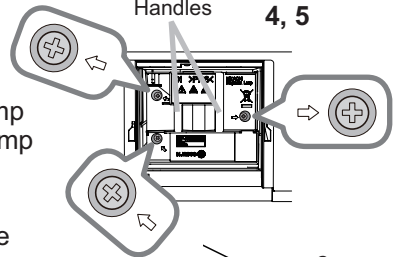

6

⚠ CAUTION ▶ Do not touch the interior of the projector, while the lamp is taken out.

NOTE • Please reset the lamp time only when you have replaced the lamp, for a suitable indication about the lamp.

<http://www.pureglare.com.au>

Replacing the lamp (continued)

⚠ HIGH VOLTAGE ⚠ HIGH TEMPERATURE ⚠ HIGH PRESSURE

ENGLISH

⚠ WARNING ▶ The projector uses a high-pressure mercury glass lamp. The lamp can break with a loud bang, or burn out, if jolted or scratched, handled while hot, or worn over time. Note that each lamp has a different lifetime, and some may burst or burn out soon after you start using them. In addition, if the bulb bursts, it is possible for shards of glass to fly into the lamp housing, and for gas containing mercury and dust containing fine particles of glass to escape from the projector's vent holes.

▶ **About disposal of a lamp:** This product contains a mercury lamp; do not put it in a trash. Dispose of it in accordance with environmental laws.

- For lamp recycling, go to www.lamprecycle.org (in the US).
- For product disposal, consult your local government agency or www.eiae.org (in the US) or www.epsc.ca (in Canada).

For more information, ask your dealer.

 Disconnect the plug from the power outlet

- If the lamp should break (it will make a loud bang when it does), unplug the power cord from the outlet, and make sure to request a replacement lamp from your local dealer. Note that shards of glass could damage the projector's internals, or cause injury during handling, so please do not try to clean the projector or replace the lamp yourself.
- If the lamp should break (it will make a loud bang when it does), ventilate the room well, and make sure not to inhale the gas or fine particles that come out from the projector's vent holes, and not to get them into your eyes or mouth.
- Before replacing the lamp, turn the projector off and unplug the power cord, then wait at least 45 minutes for the lamp to cool sufficiently. Handling the lamp while hot can cause burns, as well as damaging the lamp.



- Never unscrew except the appointed (marked by an arrow) screws.
- Do not open the lamp cover while the projector is suspended from a ceiling. This is dangerous, since if the lamp's bulb has broken, the shards will fall out when the cover is opened. In addition, working in high places is dangerous, so ask your local dealer to have the lamp replaced even if the bulb is not broken.
- Do not use the projector with the lamp cover removed. At the lamp replacing, make sure that the screws are screwed in firmly. Loose screws could result in damage or injury.



- Use only the lamp of the specified type. Use of a lamp that does not meet the lamp specifications for this model could cause a fire, damage or shorten the life of this product.
- If the lamp breaks soon after the first time it is used, it is possible that there are electrical problems elsewhere besides the lamp. If this happens, consult your local dealer or a service representative.
- Handle with care: jolting or scratching could cause the lamp bulb to burst during use.
- Using the lamp for long periods of time, could cause it dark, not to light up or to burst. When the pictures appear dark, or when the color tone is poor, please replace the lamp as soon as possible. Do not use old (used) lamps; this is a cause of breakage.

<http://www.pureglare.com.au>

Cleaning and replacing the air filter

Please check and clean the air filter periodically. When the indicators or a message prompts you to clean the air filter, comply with it as soon as possible. The filter unit with 2 sheets of filters is inside of the filter cover. An extra air filter is also attached to inner side of the filter cover. If one of the filters is damaged or heavily soiled, replace whole filter set with a new one.

Request for a filter set with the following type number from your dealer when purchasing a new one.

Type number : 003-004135-01 (UX38241)

1. Turn the projector off, and unplug the power cord. Allow the projector to sufficiently cool down.
2. Use a vacuum cleaner on and around the filter cover.
3. Pick and pull up the filter cover knobs to take it off.
4. Press up slightly the bottom side knobs to unlock the bottom side of the filter unit. Pull the center knob to take the filter unit off.
5. Use a vacuum cleaner for the filter vent of the projector and the outer side of the filter unit.
6. The filter unit consists of two parts. Press down around the interlocking parts to unlock, then separate the two parts.
7. Use a vacuum cleaner for the inner side of each part of the filter unit to clean them up. If the filters are damaged or heavily soiled, replace them with the new ones.
8. Combine the two parts to reassemble the filter unit.
9. Put the filter unit back into the projector.

(continued on next page)

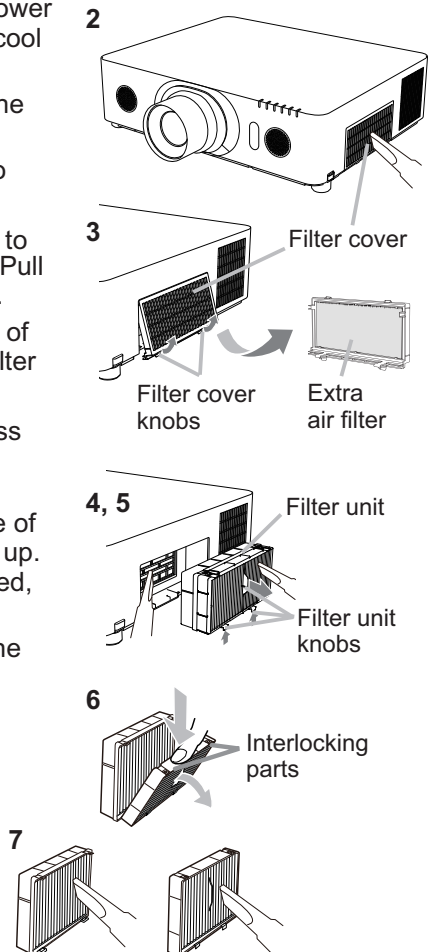

10. Put the filter cover back into the place.
11. Turn the projector on and reset the filter time using the FILTER TIME item in the EASY MENU.
 - (1) Press the **MENU** button to display a menu.
 - (2) Point at the FILTER TIME using the ▲/▼ cursor buttons, then press the ► cursor (or the **ENTER** / the **RESET**) button. A dialog will appear.
 - (3) Press the ► cursor button to select the “OK” on the dialog. It performs resetting the filter time.

⚠ WARNING ► Before taking care of the air filter, make sure the power cable is not plugged in, then allow the projector to cool sufficiently.

► Use only the air filter of the specified type. Do not use the projector without the air filter or the filter cover. It could result in a fire or malfunction to the projector.

► Clean the air filter periodically. If the air filter becomes clogged by dust or the like, internal temperatures rise and could cause a fire, a burn or malfunction to the projector.

NOTE • Please reset the filter time only when you have cleaned or replaced the air filter, for a suitable indication about the air filter.
• The projector may display the message such as the “CHECK THE AIR FLOW” or turn off the projector, to prevent the internal heat level rising.

Using the CD manual

The other manuals for this product are written into the included CD-ROM titled "Projector User Manual". Before using the CD-ROM, please read the following to ensure the proper use.

■ System requirements

The system for using the CD-ROM requires the following.

Windows®: OS:Windows® XP, Windows Vista®, Windows® 7 or later

Macintosh®: OS:Mac OS® 10.2 or later

CD-ROM/DVD-ROM drive

Applications: Microsoft® Internet Explorer®6.0 and
Adobe® Acrobat® Reader® 8.0 or late

■ How to use the CD

1. Insert CD into computer's CD-ROM/DVD-ROM drive.

Windows®: In a while, Web browser automatically starts. Start up window comes up.

Macintosh®: (1) Double-click on the "Projectors" icon appeared on the desktop screen.
(2) When "main.html" file is clicked, Web browser will start and Initial window will appear.

2. Click the model name of your projector first, and then click language you want from the displayed list. The User manual (detailed) will open.

⚠ CAUTION ▶ Only use the CD-ROM in a computer CD/DVD drive. The CD-ROM is designed for computer use only. NEVER INSERT THE CD-ROM INTO A NON-COMPUTER CD/DVD PLAYER! Inserting the CD-ROM into an incompatible CD/DVD drive may produce a loud noise, which in turn MAY RESULT IN EAR AND SPEAKER DAMAGE!

- After using CD-ROM, please put it into CD case and keep it. Please keep the CD neither in direct sunlight nor in a high temperature and high humidity environment.

NOTE • The information in the CD-ROM is subject to change without notice. Please check our website where you may find the latest information for this projector. (📖)

- No responsibility is taken for any obstacle and defect to hardware and software of your computer as a result of the use of the CD-ROM.
- All or Any part of the information in the CD-ROM must not be copied, reproduced or republished without notice to our company.

Item	Specification
Product name	Liquid crystal projector
Liquid Crystal Panel	<p>LX501, LX601i: 786,432 pixels (1024 horizontal x 768 vertical)</p> <p>LW401, LW551i: 1,024,000 pixels (1280 horizontal x 800 vertical)</p> <p>LWU421, LWU501i: 2,304,000 pixels (1920 horizontal x 1200 vertical)</p>
Lamp	<p>LX501, LW401, LWU421: 245 W UHP</p> <p>LX601i, LW551i, LWU501i: 330 W UHP</p>
Speaker	8 W x2
Power supply, Rated current	<p>LX501, LW401, LWU421: AC100-120 V: 3.8 A, AC220-240 V: 1.9 A</p> <p>LX601i, LW551i, LWU501i: AC100-120 V: 4.9 A, AC220-240 V: 2.4 A</p>
Power consumption	<p>LX501, LW401, LWU421: AC100-120 V: 375 W, AC220-240 V: 355 W</p> <p>LX601i, LW551i, LWU501i: AC100-120 V: 480 W, AC220-240 V: 455 W</p>
Temperature range	0 ~ 40 °C (Operating)
Size	<p>498 (W) x 135 (H) x 396 (D) mm</p> <p>* Not including protruding parts. Refer to figure F-5 at the back of this manual.</p>
Weight (mass)	<p>LX501, LW401, LWU421: approx. 8.4 kg</p> <p>LX601i, LW551i, LWU501i: approx. 8.8 kg</p>

(continued on next page)

Regulatory notices (continued)

Item	Specification
Ports	<p>COMPUTER IN1 D-sub 15 pin mini jack x1 COMPUTER IN2 (H, V, G/Y, B/Cb/Pb, R/Cr/Pr) BNC jack x5 HDMI 1 HDMI connector x1 HDMI 2 HDMI connector x1 MONITOR OUT D-sub 15 pin mini jack x1 COMPONENT (Y, Cb/Pb, Cr/Pr) RCA jack x3 S-VIDEO Mini DIN 4 pin jack x1 VIDEO RCA jack x1 AUDIO IN1 3.5 mm (stereo) mini jack x1 AUDIO IN2 3.5 mm (stereo) mini jack x1 AUDIO IN3 (L, R) RCA jack x2 AUDIO OUT (L, R) RCA jack x2 USB TYPE A USB type A connector x2 USB TYPE B USB type B connector x1 CONTROL D-sub 9 pin plug x1 LAN RJ45 jack x1 REMOTE CONTROL IN 3.5 mm (stereo) mini jack x1 REMOTE CONTROL OUT 3.5 mm (stereo) mini jack x1</p>
Optional parts	<p>Lamp: <LX501, LW401, LWU421> 003-120707-01 (DT01285) <LX601i, LW551i, LWU501i> 003-120708-01 (DT01295) Filter set: 003-004135-01 (UX38241) * For more information, please consult your dealer.</p>

Troubleshooting - Warranty and after-service

If an abnormal operation (such as smoke, strange odor or excessive sound) should occur, stop using the projector immediately.

Otherwise if a problem occurs with the projector, first refer to “Troubleshooting” of **User Manual - Operating Guide, Network Guide and Instant Stack Guide**, and run through the suggested checks.

If this does not resolve the problem, please consult your dealer or service company. They will tell you what warranty condition is applied.

Please check the following web address where you may find the latest information for this projector.

<http://www.christiedigital.com>

NOTE • The information in this manual is subject to change without notice.

- The illustrations shown in this manual are one example for explanation. On your projector, there may be some differences from the illustrations.
- The manufacturer assumes no responsibility for any errors that may appear in this manual.
- The reproduction, transfer or copy of all or any part of this document is not permitted without express written consent.

Trademark acknowledgment

- Mac®, Macintosh® and Mac OS® are registered trademarks of Apple Inc.
- Pentium® is a registered trademark of Intel Corp.
- Adobe® and Acrobat®, Reader® are registered trademarks of Adobe Systems Incorporated.
- Microsoft®, Internet Explorer®, Windows®, Windows NT® and Windows Vista® are registered trademarks of Microsoft Corporation in the U.S. and/or other countries.
- HDMI™, the HDMI logo and High-Definition Multimedia Interface are trademarks or registered trademarks of HDMI Licensing LLC in the United States and other countries.
- Blu-ray Disc™ and Blu-ray™ are trademarks of Blu-ray Disc Association.

All other trademarks are the properties of their respective owners.

End User License Agreement for the Projector Software

- Software in the projector consists of the plural number of independent software modules and there exist our copyright or/and third party copyrights for each of such software modules.
- Be sure to read “End User License Agreement for the Projector Software” which is separated document. (in the CD)