

LHD700

USER MANUAL

020-000422-01

CHRISTIE®

LHD700

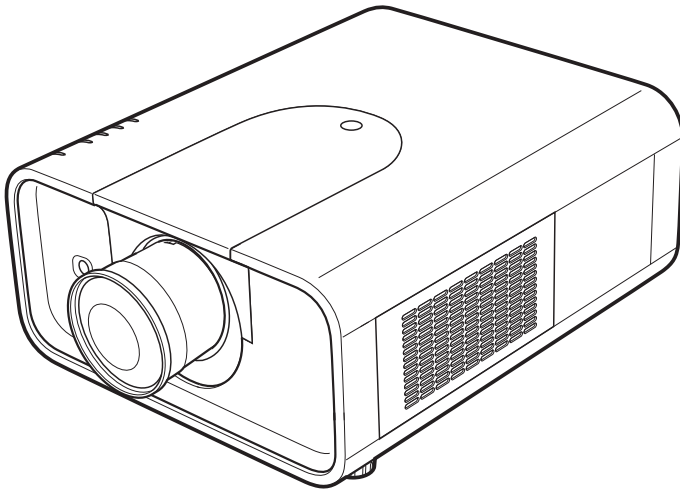

* Projection lens is optional.

User Manual

Network Supported

Refer to the User Manual below for details about network function.

- Network Set-up and Operation
- PJ Network Manager

This Multimedia Projector is designed with most advanced technology for portability, durability, and ease of use. This projector utilizes built-in multimedia features, a palette of 1.07 billion colors, and matrix liquid crystal display (LCD) technology.

This projector employs Full HD LCD panels with 1,920x1,080 pixels, allowing it to project high resolution signals at their native resolution.

◆ Functionally Rich

This projector has many useful functions such as lens shifting, ceiling and rear projection, perpendicular omnidirectional projection, a variety of lens options, etc.

◆ Multi-use Remote Control

Use the remote control as wired and wireless, or as a PC wireless mouse. Eight remote control codes and selectable pointer shapes are also available.

◆ Simple Computer System Setting

The projector has the Multi-scan system to conform to almost all computer output signals quickly (p.35). Supported resolution up to WUXGA.

◆ Direct OFF Function

With the Direct OFF function, you can disconnect the power cord from the wall outlet or turn off the breaker even during projection.(p.24)

◆ Security Function

The Security function helps you to ensure security of the projector. With the Key lock function, you can lock the operation on the side control or remote control (p.65). PIN code lock function prevents unauthorized use of the projector. (pp.65-66)

◆ Power Management

The Power management function reduces power consumption and maintains lamp life. (p.63)

◆ Automatic Filter Replacement Function

The projector monitors the condition of the filter and replaces a filter automatically when it detects the clogging.

◆ Picture in Picture Function

This projector is capable of projecting two images simultaneously by using either built-in P in P mode or P by P mode. (pp.57-58)

✓ Note:

- The On-Screen Menu and figures in this manual may differ slightly from the product.
- The contents of this manual are subject to change without notice.

◆ Multilanguage Menu Display

Operation menu is available in 12 languages; English, German, French, Italian, Spanish, Portuguese, Dutch, Swedish, Russian, Chinese, Korean, and Japanese. (p.53)

◆ Motor-driven Lens Shift

Projection lens can be moved up, down, right and left with the motor-driven lens shift function. This function makes it easy to provide projected image where you want. Zoom and focus can also be adjusted with a motor-driven operation. (p.27)

◆ Multiple Interface Terminals

The projector has many interface terminals that can support various types of equipment and signals. (p.11)

◆ Shutter Function

The projector is equipped with the shutter that provides complete blackness when the projected image is not needed with keeping the projector on. The shutter management function allows you to set the timer. It prevents from keeping the projector on when the shutter is closed for a long time. (p.67)

◆ Corner Correction

With the "Horizontal and vertical keystone correction function" and "Corner keystone correction function" of this projector, you can correct the keystone distortion even when projecting from the diagonal to the screen. (pp.30, 45, 52)

◆ LAN Network Function

Operation and monitoring of the projector can be carried out via a network. By installing Network unit (sold separately), the projector can be operated and monitored via a network, and the projector can also project computer screen images via the network. In addition, Crestron RoomView® and AMX Device Discovery functions can only be used via the projector's built-in LAN. For details, refer to the user manual "Network Setup and Operation."

Features and Design	2	Computer Input	35
Table of Contents	3	Computer System Selection	35
To The Owner	4	Auto PC Adjustment	36
Safety Instructions	5	Manual PC Adjustment	37
Air Circulation	6	Image Level Selection	39
Installing the Projector in Proper Directions	7	Image Adjustment	40
Moving the Projector	8	Screen Size Adjustment	43
Cautions in Handling the Projector	8	Video Input	46
Compliance	9	Video System Selection	46
Part Names and Functions	10	Image Level Selection	47
Rear Terminal	11	Image Adjustment	48
Side Control and Indicators	12	Screen Size Adjustment	51
Remote Control	13	Setting	53
Remote Control Battery Installation	15	Setting	53
Remote Control Receivers and Operating Range	15	Maintenance and Care	71
Wired Remote Control Transmitter	15	Filter Instructions	71
Adjustable Feet	16	Replacing the Filter Cartridge	72
Remote Control Code	16	Resetting the Filter Counter	73
Installation	17	Resetting the Scroll Counter	73
Lens Installation	17	Lamp Replacement	74
Connecting to a Computer		Cleaning the Projection Lens	76
(Digital and Analog RGB)	20	Cleaning the Projector Cabinet	76
Connecting to Video Equipment		Warning Indicators	77
(Video, S-video, HDMI)	21	Appendix	78
Connecting the AC Power Cord	22	Troubleshooting	78
Basic Operation	23	Menu Tree	81
Turning On the Projector	23	Indicators and Projector Condition	85
Turning Off the Projector	24	Compatible Computer Specifications	88
How to Operate the On-Screen Menu	25	Technical Specifications	90
Main Menu	26	Optional Parts	91
Operating with Projector Control	27	Lens Replacement	91
Operating with Remote Control	28	Configurations of Terminals	92
Keystone Correction	30	PIN Code Number Memo	93
Pointer Function	31	Dimensions	94
Wireless Mouse Operation	31	List of Picture in Picture	95
Input Selection	32	Serial Control Interface	95
Direct Operation	32		
Computer Input Source Selection	33		
Video Input Source Selection	34		

Trademarks

Each name of a registered product in this book is either a registered trademark or a trademark of its respective corporation.

Before installing and operating the projector, read this manual thoroughly.

The projector provides many convenient features and functions. Operating the projector properly enables you to manage those features and maintains it in good condition for many years to come.

Improper operation may result in not only shortening the product life, but also malfunctions, fire hazard, or other accidents.

If your projector seems to operate improperly, read this manual again, check operations and cable connections and try the solutions in the "Troubleshooting" section in the back of this manual. If the problem still persists, contact the dealer where you purchased the projector or the service center.

	CAUTION RISK OF ELECTRIC SHOCK DO NOT OPEN	
CAUTION :TO REDUCE THE RISK OF ELECTRIC SHOCK, DO NOT REMOVE COVER (OR BACK). NO USER-SERVICEABLE PARTS INSIDE EXCEPT LAMP REPLACEMENT. REFER SERVICING TO QUALIFIED SERVICE PERSONNEL.		
	THIS SYMBOL INDICATES THAT DANGEROUS VOLTAGE CONSTITUTING A RISK OF ELECTRIC SHOCK IS PRESENT WITHIN THIS UNIT.	
	THIS SYMBOL INDICATES THAT THERE ARE IMPORTANT OPERATING AND MAINTENANCE INSTRUCTIONS IN THE USER MANUAL WITH THIS UNIT.	

FOR EU USERS

The symbol mark and recycling systems described below apply to EU countries and do not apply to countries in other areas of the world.

Your product is designed and manufactured with high quality materials and components which can be recycled and/or reused.

The symbol mark means that electrical and electronic equipment, batteries and accumulators, at their end-of-life, should be disposed of separately from your household waste.

Note:

If a chemical symbol is printed beneath the symbol mark, this chemical symbol means that the battery or accumulator contains a heavy metal at a certain concentration. This will be indicated as follows: Hg: mercury, Cd: cadmium, Pb: lead.

In the European Union there are separate collection systems for used electrical and electronic equipment, batteries and accumulators.

Please, dispose of them correctly at your local community waste collection/ recycling centre.

Please, help us to conserve the environment we live in!



<http://www.pureglare.com.au>



Safety Precaution

WARNING: • THIS APPARATUS MUST BE EARTHED.

• TO REDUCE THE RISK OF FIRE OR ELECTRIC SHOCK, DO NOT EXPOSE THIS APPLIANCE TO RAIN OR MOISTURE.

- This projector produces intense light from the projection lens. Do not stare directly into the lens, otherwise eye damage could result. Be especially careful that children do not stare directly into the beam.
- Install the projector in a proper position. Otherwise it may result in a fire hazard.
- Allowing the proper amount of space on the top, sides, and rear of the projector cabinet is critical for proper air circulation and cooling of the unit. The diagrams shown here indicate the minimum space required. If the projector is to be built into a compartment or similarly enclosed, these minimum distances must be maintained.

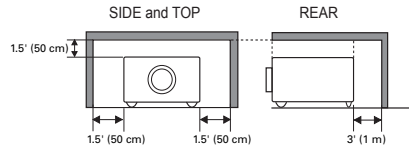

Do not cover the ventilation slots on the projector. Heat build-up can shorten the service life of your projector, and can also be dangerous.

- If the projector is unused for an extended time, unplug the projector from the power outlet.
- Do not project the same image for a long time. The afterimage may remain on the LCD panels by the characteristic of panel.



CAUTION ON HANGING FROM THE CEILING

DO NOT SET THE PROJECTOR IN GREASY, WET, OR SMOKY CONDITIONS SUCH AS IN A KITCHEN TO PREVENT A BREAKDOWN OR A DISASTER. IF THE PROJECTOR COMES IN CONTACT WITH OIL OR CHEMICALS, IT MAY BECOME DETERIORATED.

CAUTION

Not for use in a computer room as defined in the Standard for the Protection of Electronic Computer/ Data Processing Equipment, ANSI/NFPA 75.

READ AND KEEP THIS USER MANUAL FOR LATER USE.

All the safety and operating instructions should be read before the product is operated.

Read all of the instructions mentioned here and retain them for later use. Unplug this projector from AC power supply before cleaning. Do not use liquid or aerosol cleaners. Use a damp cloth for cleaning.

Follow all warnings and instructions marked on the projector.

For added protection to the projector during a lightning storm, or when it is left unattended and unused for long periods of time, unplug it from the wall outlet. This will prevent damage due to lightning and power line surges.

Do not expose this unit to rain or operate it near water for example, in a wet basement, near a swimming pool, etc...

Do not use attachments not recommended by the manufacturer as they may cause hazards.

Do not place this projector on an unstable cart, stand, or table. The projector may fall, causing serious injury to a child or adult, and serious damage to the projector. Use only with a cart or stand recommended by the manufacturer, or sold with the projector. Wall or shelf mounting should follow the manufacturer's instructions, and should use a mounting kit approved by the manufacturers.



An appliance and cart combination should be moved with care. Quick stops, excessive force, and uneven surfaces may cause the appliance and cart combination to overturn.

Slots and openings in the back and side of the cabinet are provided for ventilation, to ensure reliable operation of the equipment and to protect it from overheating.

The openings should never be covered with cloth or other materials, and the bottom opening should not be blocked by placing the projector on a bed, sofa, rug, or other similar surface. This projector should never be placed near or over a radiator or heat register.

This projector should not be placed in a built-in installation such as a book case unless proper ventilation is provided.

Never push objects of any kind into this projector through cabinet slots as they may touch dangerous voltage points or short out parts that could result in a fire or electric shock. Never spill liquid of any kind on the projector.

Do not install the projector near the ventilation duct of air-conditioning equipment.

This projector should be operated only from the type of power source indicated on the marking label. If you are not sure of the type of power supplied, consult your authorized dealer or local power company.

Do not overload wall outlets and extension cords as this can result in fire or electric shock. Do not allow anything to rest on the power cord. Do not locate this projector where the cord may be damaged by persons walking on it.

Do not attempt to service this projector yourself as opening or removing covers may expose you to dangerous voltage or other hazards. Refer all servicing to qualified service personnel.

Unplug this projector from wall outlet and refer servicing to qualified service personnel under the following conditions:

- a. When the power cord or plug is damaged or frayed.
- b. If liquid has been spilled into the projector.
- c. If the projector has been exposed to rain or water.
- d. If the projector does not operate normally by following the operating instructions. Adjust only those controls that are covered by the operating instructions as improper adjustment of other controls may result in damage and will often require extensive work by a qualified technician to restore the projector to normal operation.
- e. If the projector has been dropped or the cabinet has been damaged.
- f. When the projector exhibits a distinct change in performance-this indicates a need for service.

When replacement parts are required, be sure the service technician has used replacement parts specified by the manufacturer that have the same characteristics as the original part. Unauthorized substitutions may result in fire, electric shock, or injury to persons.

Upon completion of any service or repairs to this projector, ask the service technician to perform routine safety checks to determine that the projector is in safe operating condition.

NOTE FOR CUSTOMERS IN THE US

Ⓜ(Hg) LAMP(S) INSIDE THIS PRODUCT CONTAIN MERCURY AND MUST BE RECYCLED OR DISPOSED OF ACCORDING TO LOCAL, STATE OR FEDERAL LAWS.

Air Circulation

Openings in the cabinet are provided for ventilation. To ensure reliable operation of the product and to protect it from overheating, these openings must not be blocked or covered.

CAUTION

Hot air is exhausted from the exhaust vent. When using or installing the projector, the following precautions should be taken.

- Do not put any flammable object or spray can near the projector, as hot air is exhausted from the air vents.
- Keep the exhaust vent at least 3' (1 m) away from any objects.
- Do not touch peripheral parts of the exhaust vent, especially screws and metallic parts. These areas will become hot while the projector is being used.
- Do not put anything on the cabinet. Objects put on the cabinet will not only get damaged but also may cause fire hazard by heat.

Cooling fans are provided to cool down the projector. The fans' running speed is changed according to the temperature inside the projector.

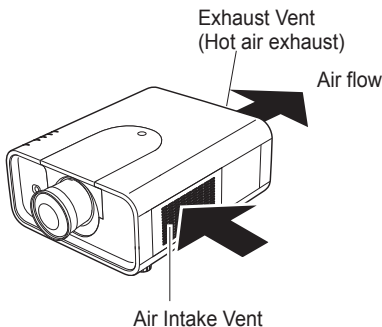

IMPORTANT! Filter Maintenance!!

The projector uses a lamp which generates significant heat. The cooling fans and air vents are provided to dissipate the heat by drawing air into the housing and the filter is located in the intake vents to prevent dust from getting inside of the projector.

In order to care for the projector appropriately, regular cleaning is required. Remove any dirt or dust that has accumulated on the projector.

If the projector reaches a time set in the timer setting, a Filter replacement icon (Fig. 1) appears on the screen and WARNING FILTER indicator on the top panel lights up (see below), indicating that the filter replacement is necessary.

If the projector detects that the filter is clogged and no scroll is left in the filter cartridge, a Filter cartridge replacement icon (Fig. 2) appears on the screen and WARNING FILTER indicator on the top panel lights up (see below). Stop using the projector immediately and replace the filter cartridge.

Blocking the air vents and leaving the projector uncleaned for a long time may not only damage the projector and may require costly repairs but may also cause accidents or fire.

For maintenance of the filter, refer to "Filter counter" on page 70 and "Maintenance and Care" on pages 71-73.

Damages to the projector caused by using an uncleaned filter or improper maintenance will void the warranty on the projector.

Top Panel

LAMP / SHUTTER

LAMP REPLACE

WARNING FILTER

WARNING TEMP.

WARNING FILTER indicator



Fig. 1 Filter replacement icon



Fig. 2 Filter cartridge replacement icon

Installing the Projector in Proper Directions

Use the projector properly in specified positions. Improper positioning may shorten the lamp life and result in severe accidents or fire hazard.

This projector can project the picture in upward, downward, or inclined position in perpendicular direction to the horizontal plane. When installing the projector in downwardly inclined position, install the projector bottom side up.

✓ **Note:**

*To inverse or reverse the image, set the ceiling function to **On**. (pp. 45, 52)*

Positioning Precautions

Avoid positioning the projector as described below when installing.

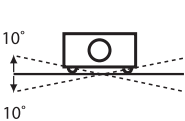

Do not tilt the projector more than 10 degrees from side to side.



Do not put the projector on either side to project an image.



In upward projection, do not tilt the projector over 10 degrees right and left.



In downward projection, do not tilt the projector over 10 degrees right and left.



CAUTION ON CEILING MOUNTING

For ceiling mounting, you need the ceiling mount kit designed for this projector. When not mounted properly, the projector may fall, causing hazards or injury. For details, consult your dealer. The warranty on this projector does not cover any damage caused by use of any non-recommended ceiling mount kit or installation of the ceiling mount kit in an improper location.



Cautious use of equipment with laser technology

Do not radiate strong light such as laser light on the projection lens directly, as this may degrade the functionality of the projector, and will void any applicable warranties.

Moving the Projector

Use the handle grip when moving the projector.

Retract the adjustable feet to prevent damage to the lens and cabinet when carrying.

When this projector is not in use for an extended period, put it into a suitable case to protect the projector.

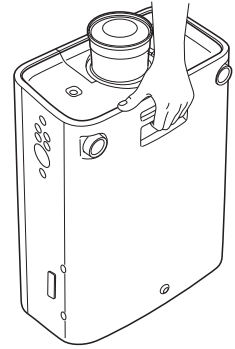

CAUTION IN CARRYING OR TRANSPORTING THE PROJECTOR

- Do not drop or bump the projector, otherwise damages or malfunctions may result.
- When carrying the projector, use a suitable carrying case.
- Do not transport the projector by courier or any other transport service in an unsuitable transport case. This may cause damage to the projector. For information about transporting the projector by courier or any other transport service, consult your dealer.
- Do not put the projector in a case before it is cooled enough.

Cautions in Handling the Projector

Do not hold the lens or the top cover when lifting or moving the projector. Doing so may cause damage to the lens and the projector.

Care must be taken when handling the projector; do not drop, bump, subject it to strong forces, or put other things on the cabinet.

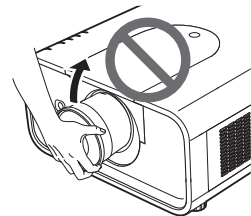
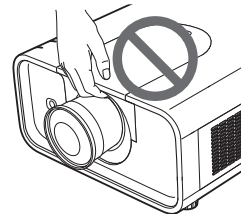

Do not hold the lens and the peripheral part.



CAUTION

Projection lens is a motorized lens. Please note the followings when using the projector.

- Do not touch the lens while it is moving as this could cause injury to the fingers.
- Never allow children to touch the lens.

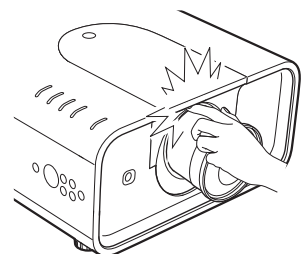

Federal Communications Commission Notice

This equipment has been tested and found to comply with the limits for a Class A digital device, pursuant to Part 15 of FCC Rules. These limits are designed to provide reasonable protection against harmful interference when the equipment is operated in a commercial environment. This equipment generates, uses, and can radiate radio frequency energy and, if not installed and used in accordance with the instruction manual, may cause harmful interference to radio communications. Operation of this equipment in a residential area is likely to cause harmful interference in which case the user will be required to correct the interference at his own expense.

Do not make any changes or modifications to the equipment unless otherwise specified in the instructions. If such changes or modifications should be made, you could be required to stop operation of the equipment.

Canadian Radio Interference Regulations

This Class A digital apparatus meets all requirements of the Canadian ICES-003.

WARNING

This is a Class A product. In a domestic environment this product may cause radio interference in which case the user may be required to take adequate measures.

AC Power Cord Requirement

The AC Power Cord supplied with this projector meets the requirement for use in the country you purchased it.

AC Power Cord for the United States and Canada:

AC Power Cord used in the United States and Canada is listed by the Underwriters Laboratories (UL) and certified by the Canadian Standard Association (CSA).

AC Power Cord has a grounding-type AC line plug. This is a safety feature to be sure that the plug will fit into the power outlet. Do not try to defeat this safety feature. Should you be unable to insert the plug into the outlet, contact your electrician.

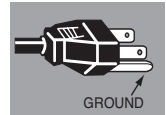

THE SOCKET-OUTLET SHOULD BE INSTALLED NEAR THE EQUIPMENT AND EASILY ACCESSIBLE.

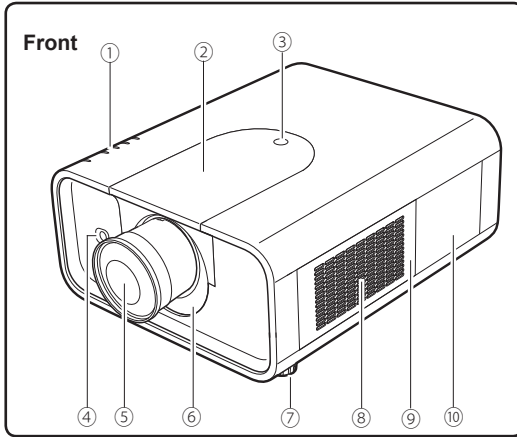

- ① Indicators
- ② Top Cover
- ③ Top Cover Release Button
- ④ Infrared Remote Receiver (Front)
- ⑤ Projection Lens (optional)
- ⑥ Light-Block Sheet
- ⑦ Adjustable Feet
- ⑧ Air Intake Vent
- ⑨ Filter Cover
- ⑩ Lamp Cover
- ⑪ Exhaust Vent

⚠ CAUTION

Hot air is exhausted from the exhaust vent. Do not put heat-sensitive objects near this side.

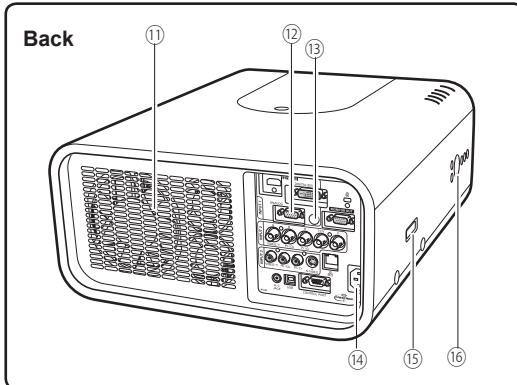

- ⑫ Terminals and Connectors
- ⑬ Infrared Remote Receiver (Back)
- ⑭ Power Cord Connector
- ⑮ Optional Parts Attachment
- ⑯ Side Controls
- ⑰ Hand Grip

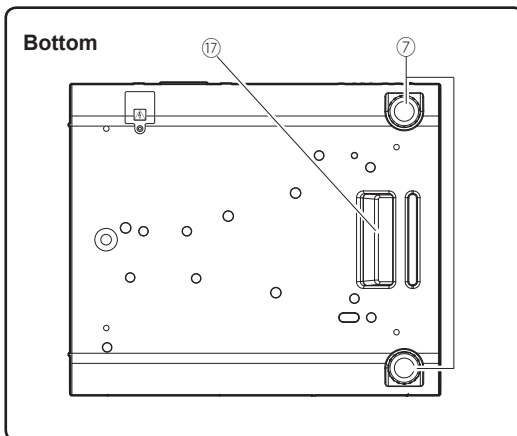

Rear Terminal

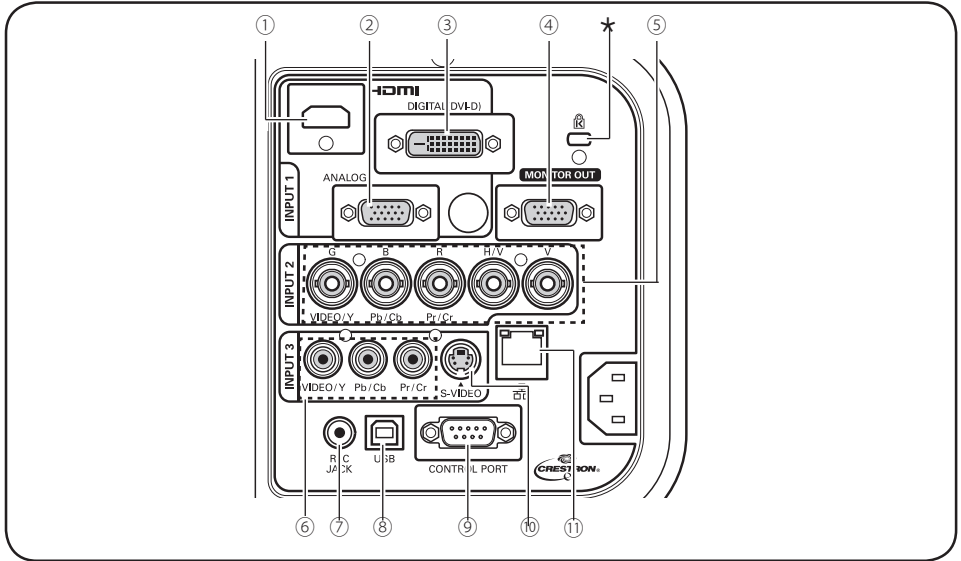

① HDMI TERMINAL

Connect the HDMI signal from video equipment or the DVI signal from computer to this terminal (pp.20, 21).

HDMI is registered trademarks of HDMI Licensing, LLC.

② COMPUTER INPUT TERMINAL (ANALOG)

Connect the computer (or RGB scart) output signal to this terminal (pp.20, 21).

③ COMPUTER INPUT TERMINAL (DIGITAL)

Connect the computer output digital signal to this terminal. The HDTV (HDCP compatible) signal can also be connected (pp.20, 21).

④ MONITOR OUT TERMINAL

This terminal can be used to output the incoming analog RGB signal from INPUT 1-3 terminal to the other monitor (pp.20, 21).

⑤ 5 BNC INPUT JACKS

Connect the component or composite video output signal from video equipment to VIDEO/Y, Pb/Cb, and Pr/Cr jacks or connect the computer output signal (5 BNC Type [Green, Blue, Red, Horiz. Sync, and Vert. Sync.]) to G, B, R, H/V, and V jacks (pp.20, 21).

⑥ VIDEO INPUT JACK

Connect the component or the composite video output signal from video equipment to these jacks (p.21).

⑦ R/C JACK

When using the wired remote control, connect the wired remote control to this jack with a remote control cable (not supplied) (p.15).

⑧ USB CONNECTOR (Series B)

Use this connector when controlling a computer with the remote control of the projector. Connect the USB terminal of your computer to this connector with a USB cable (p.20).

⑨ CONTROL PORT CONNECTOR

When controlling the projector with RS-232C, connect the control equipment to this connector with the serial control cable (p.20).

⑩ S-VIDEO INPUT JACK

Connect the S-VIDEO output signal from video equipment to this jack (p.21).

⑪ LAN CONNECTION TERMINAL

Connect the LAN cable (refer to the user manual of "Network Set-up and Operation").

*** Kensington Security Slot**

This slot is for a Kensington lock used to deter theft of the projector.

*Kensington is a registered trademark of ACCO Brands Corporation.

<http://www.pureglare.com.au>

Side Control and Indicators

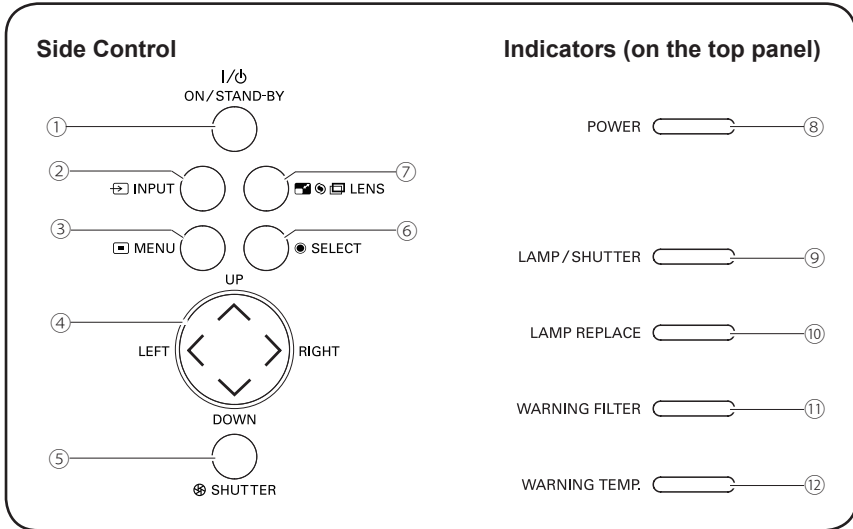

- ① **ON/STAND-BY button**
Turn the projector on or off (pp.23–24).
- ② **INPUT button**
Select an input source (pp.32–34).
- ③ **MENU button**
Open or close the On-Screen Menu (p.25).
- ④ **Point ▲▼◀▶ buttons**
– Select an item or adjust the value in the On-Screen Menu (p.25).
– Pan the image in Digital zoom + mode (p.44).
- ⑤ **SHUTTER button**
Close and open up the built-in shutter. (p.27)
- ⑥ **SELECT button**
– Execute the selected item (p.25).
– Expand or compress the image in the Digital zoom mode (p.44).
- ⑦ **LENS button**
Enter the focus, zoom, and lens shift adjustment mode (p.27).
- ⑧ **POWER indicator**
– Light when in stand-by mode and during operations.
– Blink in the Power management mode (p.63).
- ⑨ **LAMP/SHUTTER indicator**
Light red during operations.
Light blue when the shutter is closed (p.85).
- ⑩ **LAMP REPLACE indicator**
Light orange when the projection lamp reaches its end of life (pp.74, 84).
- ⑪ **WARNING FILTER indicator**
– Blink slow when the filter is being scrolled (pp. 71, 85).
– Blink fast when the filter scroll is not working properly or the filter cartridge is not installed (pp.71, 87).
– Light orange when the clogging of the filter is detected or the filter counter reaches a time set in the timer setting, urging immediate filter/ filter cartridge replacement (pp.70, 71, 87).
- ⑫ **WARNING TEMP. indicator**
Blink red when the internal temperature of the projector exceeds the operating range (pp.77, 85–87).

Remote Control

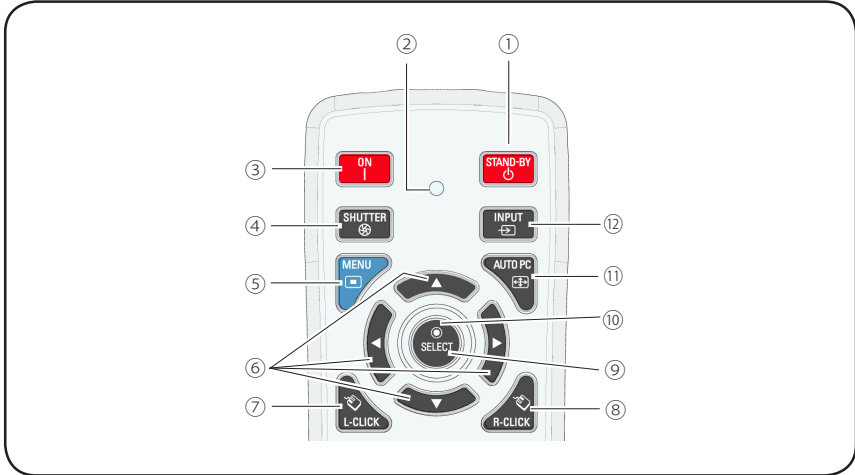

- ① **STAND-BY button**
Turn the projector off (p.24).
- ② **SIGNAL EMISSION indicator**
Light red while a signal is being sent from the remote control to the projector.
- ③ **ON button**
Turn the projector on (p.23).
- ④ **SHUTTER button**
Close and open up the built-in shutter (pp.27, 28).
- ⑤ **MENU button**
Open or close the On-Screen Menu (p.25).
- ⑥ **POINT ▲▼◀▶ buttons**
– Select an item or adjust the value in the On-Screen Menu (p.25).
– Pan the image in Digital zoom + mode (p.44).
- ⑦ **L-CLICK button**
Act as the left mouse button for wireless mouse operation (p.31).
- ⑧ **R-CLICK button**
Act as the right mouse button for wireless mouse operation (p.31).
- ⑨ **SELECT button**
– Execute the selected item (p.25).
– Expand or compress the image in the Digital zoom mode (p.44).
- ⑩ **MOUSE POINTER button**
Move a pointer of the projector or a pointer of wireless mouse operation (p.31).
- ⑪ **AUTO PC button**
Automatically adjust the computer image to its optimum setting (pp.28, 36).
- ⑫ **INPUT button**
Select a signal (pp.32-34).



To ensure safe operation, observe the following precautions:

- Do not bend, drop, or expose the remote control to moisture or heat.
- For cleaning, use a soft dry cloth. Do not apply benzene, thinner, spray, or any other chemical materials.

Remote Control

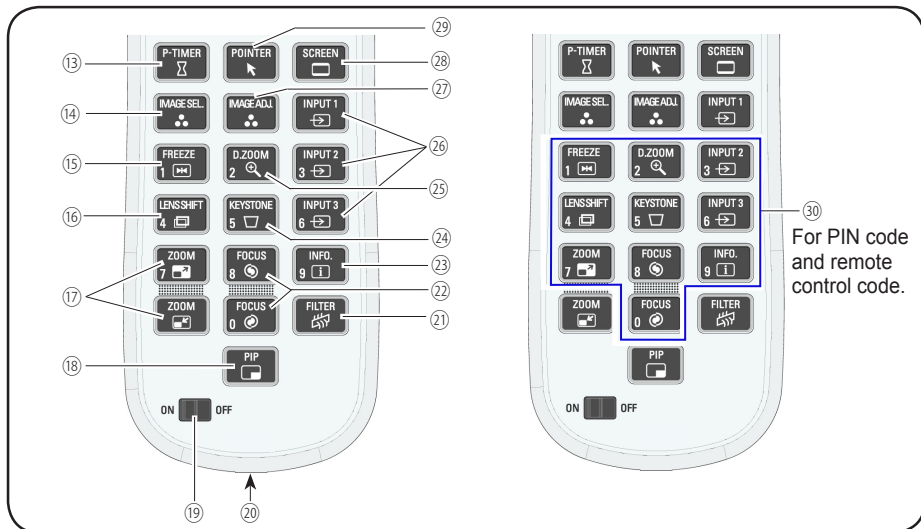

- ⑬ **P-TIMER button**
Operate the P-timer function (pp.29, 64).
- ⑭ **IMAGE SEL. button**
Operate the image selection function (pp.39, 47).
- ⑮ **FREEZE button**
Freeze the picture on the screen (p.29).
- ⑯ **LENS SHIFT button**
Select the Lens Shift function (p.28).
- ⑰ **ZOOM buttons**
Zoom in and out the images (p.28).
- ⑱ **PIP button**
Operate the Picture in Picture function (pp.29, 57-58).
- ⑲ **ON/OFF switch**
When using the remote control, set this switch to "ON". Set it to "OFF" for power saving when it is not in use (p.16).
- ⑳ **WIRED REMOTE jack**
Connect the remote control cable (not supplied) to this jack when using as a wired remote control.
- ㉑ **FILTER button**
Scroll the filter (p.29).
<http://www.pureglare.com.au>
- ㉒ **FOCUS buttons**
Adjust the focus (p.28).
- ㉓ **INFO. button**
Display the input source information (p.28).
- ㉔ **KEYSTONE button**
Correct keystone distortion (pp.30, 45, 52).
- ㉕ **D.ZOOM button**
Select the Digital zoom +/- mode and resize the image (p.44).
- ㉖ **INPUT 1- 3 buttons**
Select an input source (INPUT 1 – INPUT 3) (pp.32-34).
- ㉗ **IMAGE ADJ. button**
Operate the image adjustment function (pp.40-41, 48-49).
- ㉘ **SCREEN button**
Select the screen size (p.28).
- ㉙ **POINTER button**
Act as the On-Off switch for the Pointer (pp.29, 31, 64).
- ㉚ **NUMBER buttons**
Act as number buttons. Use these buttons when setting the remote control codes (p.16) or when entering the PIN code numbers (pp. 23, 56, 66).

Remote Control Battery Installation

1 Open the battery compartment lid.

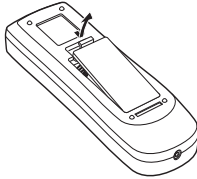

2 Install new batteries into the compartment.

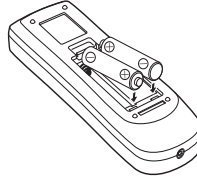

Two AAA size batteries

For correct polarity (+ and -), be sure battery terminals are in contact with pins in the compartment.

3 Replace the compartment lid.

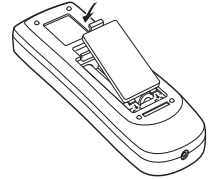

To ensure safe operation, please observe the following precautions :

- Use two (2) AAA or LR03 type alkaline batteries.
- Always replace batteries in sets.
- Do not use a new battery with a used battery.
- Avoid contact with water or liquid.
- Do not expose the remote control to moisture or heat.
- Do not drop the remote control.
- If the battery has leaked on the remote control, carefully wipe the case clean and install new batteries.
- Risk of an explosion if battery is replaced by an incorrect type.
- Dispose of used batteries according to the instructions or your local disposal rule or guidelines.

Remote Control Receivers and Operating Range

Point the remote control toward the projector (to Infrared Remote Receivers) when pressing the buttons. Maximum operating range for the remote control is about 16.4' (5 m) and 60 degrees in front, back and top of the projector.

Infrared Remote Receivers are provided in front, back and top of the projector. You can conveniently use all of the receivers (pp. 10, 11, 62).

✓ **Note:**

When hanging the projector from the ceiling, select the Infrared Remote Receiver which is located farther away from the fluorescent light (p.62).

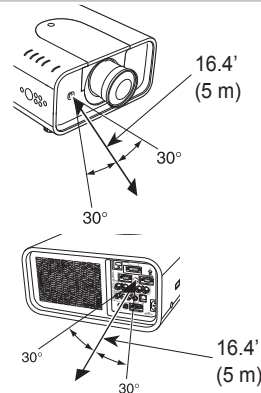

Wired Remote Control Transmitter

The remote control can be used as a wired remote control. Wired remote control helps you use the remote control outside of the operating range (16.4' / 5 m). Connect the remote control and the projector with the remote control cable (sold separately). Connected with the remote control cable, the remote control does not emit wireless signal.

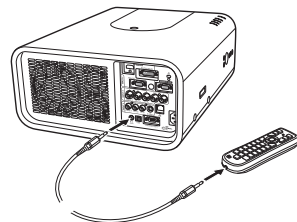

Remote Control Code

The eight different remote control codes (Code 1–Code 8) are assigned to this projector. Switching the remote control codes prevents interference from other remote controls when several projectors or video equipment next to each other are being operated at the same time. Change the remote control code for the projector first before changing that for the remote control. See “Remote control” in the Setting Menu on page 62.

- 1 Press and hold the MENU and a number button (1–8) for more than five seconds to switch among the codes.
- 2 To reset the remote control code, press and hold the MENU and the number button 0 for more than five seconds.

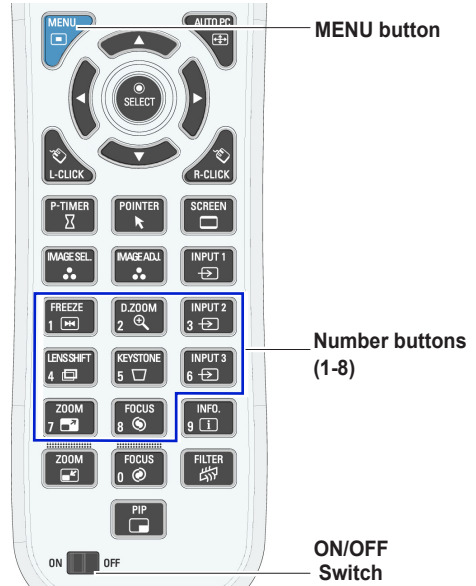

Press and hold the MENU and a number button (1-8) that corresponds to the remote control code for more than five seconds to switch among the codes.

Adjustable Feet

Projection angle can be adjusted up to 6.5 degrees with the adjustable feet.

Rotate the adjustable feet and tilt the projector to the proper height; to raise the projector, rotate the both feet clockwise.

To lower the projector or to retract the adjustable feet, rotate the both feet counterclockwise.

To correct keystone distortion, press the KEYSTONE button on the remote control or select Keystone from the menu (see pages 14, 30, 45, 52).

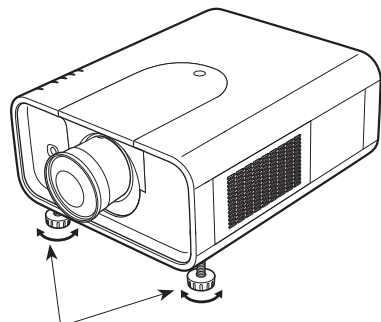

Adjustable Feet

Lens Installation

When replacing the lens or using an optional lens, install the lens by following the instructions below. Ask the sales dealer for detailed information of the optional lens specifications.

Removing the lens

- 1 Shift the lens to the center position by using the Lens shift function (p. 27).
- 2 Turn off the projector and unplug the AC power cord.
- 3 While pressing the top cover release button on the top cover, slide the top cover toward front to remove it.
- 4 Slide the light-block sheet upward and remove it.
- 5 Hold the lens with one hand and pull the Lens Lock Lever upward with the other hand. Remove the lens from the projector.
*Do not touch the glass part of the lens with your hand.



CAUTION

Be careful when handling the lens. Do not drop.

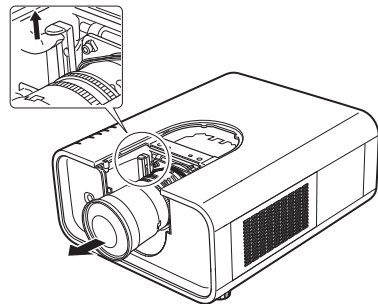
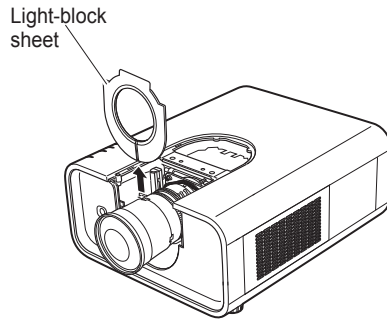
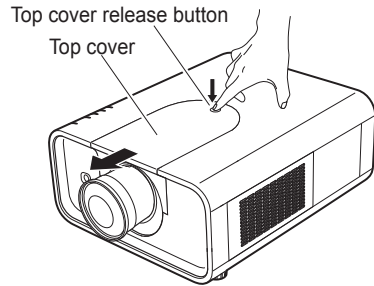

Attaching the lens to the projector

- 1 Turn off the projector and unplug the AC power cord.
- 2 Fit the lens to the projector. Make sure that the lens is fully inserted to the projector.
- 3 Push the Lens Lock Lever downward. Make sure that the lens is properly locked.
- 4 Slide the light-block sheet in the groove to mount.
- 5 While pressing the top cover release button on the top cover, slide the top cover back to the projector.

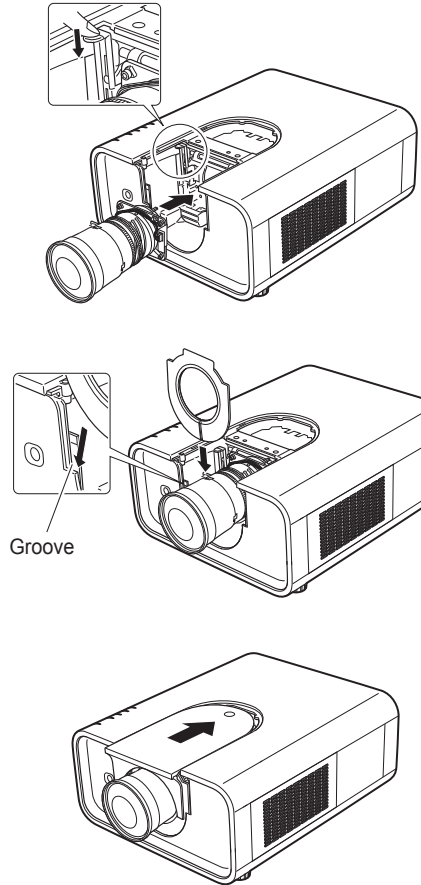

NOTES ON LENS INSTALLATION

- Do not touch or remove any parts except the lens and related parts. It may result in malfunctions, electrical shock, fire hazard or other accidents.
- Before installing or replacing the lens, check that the Model No. of the Projection Lens matches to the projector.
- For details of the lens and installation, contact the sales dealer where you purchased the projector.



Focus correction

When the lens is attached to the projector and images are being projected onto the screen, the peripheral focus may be out of focus in some localized areas. If this happens, insert the one, of three sizes of spacers, in between the Lens Attachment and the lens to adjust the focus.

Inserting the Spacer corrects the distance on the Lens Adjustment and improves the diagonal focus.

The corrected distance is determined by the thickness of the used spacers. As a guide, the distance is adjusted by approximately 30 mm for each 0.1-mm thickness of the spacers.

There are three types of spacers provided, and there are four of each spacer type. Use these spacers to correct the distance as required.

	Spacer "1" Color; Clear Thickness; 0.1 mm	Correction distance 30 mm/for 40-inch projection
	Spacer "2" Color; Black Thickness; 0.2 mm	Correction distance 55 mm/for 40-inch projection
	Spacer "3" Color; Cream Thickness; 0.3 mm	Correction distance 80 mm/for 40-inch projection

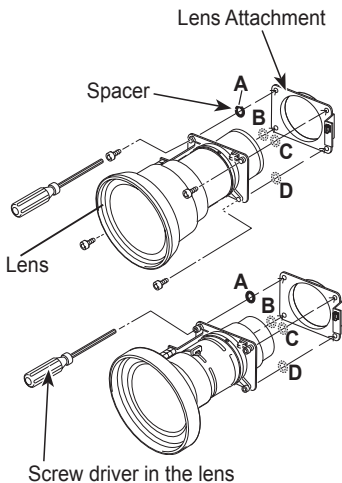
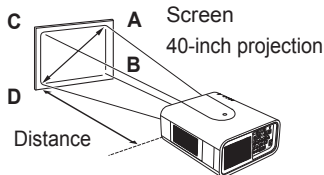

Focus adjustment

103-140106-01

Set up the projector and project image on the screen.

1. Adjust the focus to make the center area sharpest, by using the focus adjustment of the projector.

When the peripheral focus is out of focus in some localized areas, proceed to following adjustments.

2. Loosen the Focus Lock Screw of the lens. (Turn the Focus Lock Screw to counter-clockwise.)
3. Rotate the lens to obtain proper focus on outer area of the screen.
4. Lock the Focus Lock Screw securely. (Turn the Focus Lock Screw to clockwise.)

If proper focus is not observed entire screen, repeat above adjustment 1~ 4.

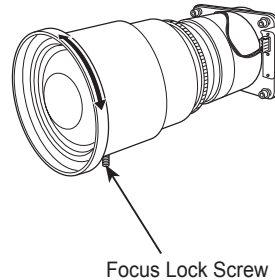

BE SURE TO CHECK FOR SAFETY

After installing or replacing the lens, be sure to check the following for safety.

1. Check the lens is securely fixed with the screws.
2. Check no wiring is damaged or tangled on the gear of the lens motor or the other mechanical parts.
3. Check no part is missing, and no mounting part is loose.



Some parts are not used for installation or replacement. Keep these parts for later use.

✓ **Note:**

- Figures in this manual may differ from the actual product.

Connecting to a Computer (Digital and Analog RGB)

Cables used for connection (* = Cables not supplied with this projector.)

- VGA Cable
- DVI-Digital cable *
- HDMI-DVI cable *
- BNC cable *
- Serial Cross cable *
- USB cable *

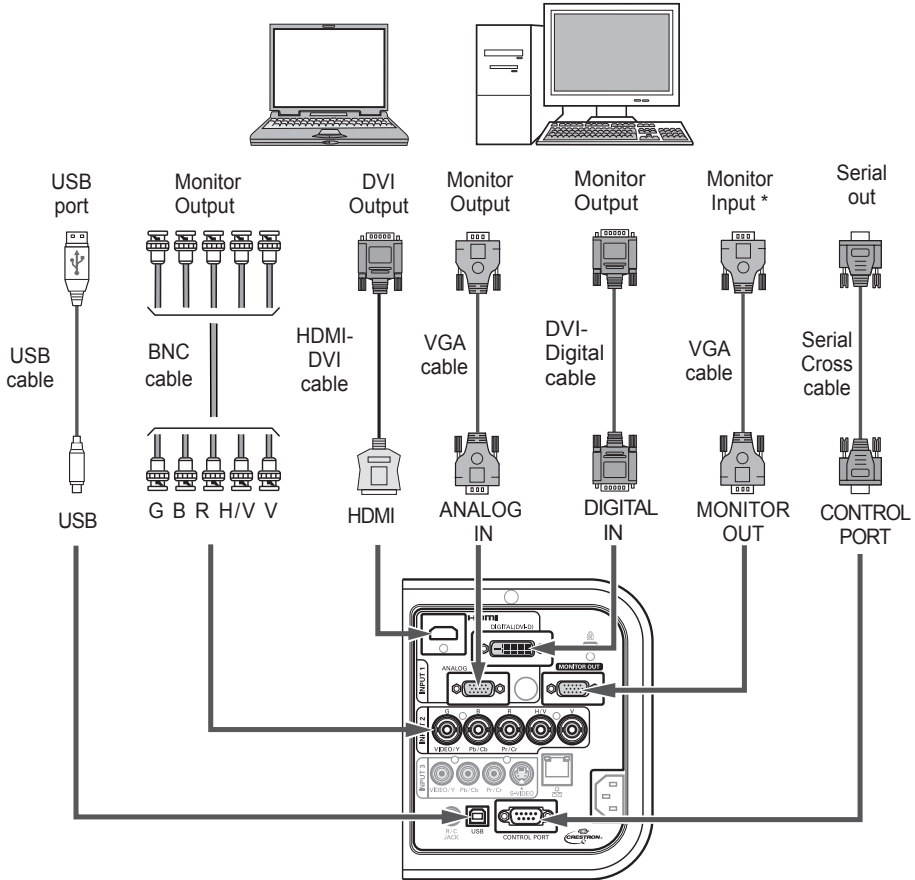

Unplug the power cords of both the projector and external equipment from the AC outlet before connecting cables.

* See the next page for the signals that can output to the MONITOR OUT terminal.

Connecting the AC Power Cord

This projector uses nominal input voltages of 100–240 V AC and it automatically selects the correct input voltage. It is designed to work with single-phase power systems having a grounded neutral conductor. To reduce the risk of electrical shock, do not plug into any other type of power system.

If you are not sure of the type of power being supplied, consult your authorized dealer or service center. Connect the projector with all peripheral equipment before turning on the projector.

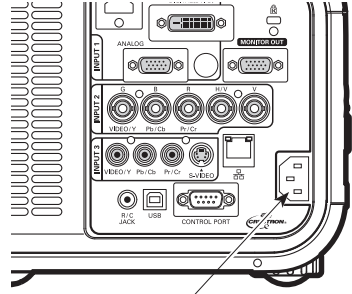

Connect the AC power cord (supplied) to the projector.



CAUTION

The AC outlet must be near this equipment and must be easily accessible.

✓ **Note:**

Unplug the AC power cord when the projector is not in use. When the projector is connected to an outlet with AC power cord, it is in stand-by mode and consumes a little electric power.

NOTE ON THE POWER CORD

AC power cord must meet the requirements of the country where you use the projector. Confirm the AC plug type with the chart below and proper AC power cord must be used. If the supplied AC power cord does not match your AC outlet, contact your sales dealer.

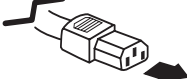
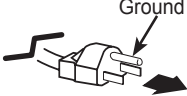
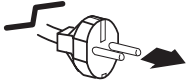
Projector side	AC Outlet side	
 To POWER CORD CONNECTOR on your projector.	For the U.S.A. and Canada	For Continental Europe
	 To the AC Outlet. (120 V AC)	 To the AC Outlet. (200–240 V AC)

Turning On the Projector

- 1 Complete peripheral connections (with a computer, VCR, etc.) before turning on the projector.
- 2 Connect the projector's AC power cord into an AC outlet. The LAMP/SHUTTER indicator lights red and the POWER indicator lights green.
- 3 Press the ON/STAND-BY button on the side control or the ON button on the remote control. The LAMP/SHUTTER indicator dims and the cooling fans start to operate. The preparation display appears on the screen and the countdown starts.
- 4 After the countdown, the input source that was selected the last time and the Lamp control status icon (see page 61) appear on the screen. If the projector is locked with a PIN code, PIN code input dialog box will appear.

✓ **Note:**

- When the Logo select function is set to **Off**, the logo will not be shown on the screen (p.54).
- When **Countdown off** or **Off** is selected in the Display function, the countdown will not be shown on the screen (p.54).
- When the Input button function is set to **Mode 3**, the input signal will be searched automatically (p.53).
- If you press the ON/STAND-BY button on the side control or the remote control during the countdown period, you can skip the countdown and go to the normal operations. In this case, however, the brightness of the image needs some time to stabilize after turning on the projector. The display may flicker after turning on the lamp for the characteristics of the lamp. This is normal operation and not a malfunction.

Enter a PIN code

Use the Point ▲ ▼ buttons on the side control or Number buttons on the remote control to enter a number.

When using side control

Use the Point ▲ ▼ buttons on the side control to select a number. Press the Point ► button to fix the number and move the red frame pointer to the next box. The number changes to *. Repeat this step to complete entering a four-digit number. After entering the four-digit number, move the pointer to "Set". Press the SELECT button so that you can start to operate the projector.

When using remote control

Press the Number buttons on the remote control to enter a number (p.14). When you complete entering a four-digit number, the pointer moves to "Set". Press the SELECT button so that you can start to operate the projector.

If you fix an incorrect number, use the Point ◀ button to move the pointer to the number you want to correct, and then enter the correct number.

If you entered an incorrect PIN code, "PIN code" and the number (****) will turn red for a moment. Enter the correct PIN code all over again.

<http://www.pureglare.com.au>



The preparation display will disappear after 30 seconds.

Selected Input Source and Lamp control

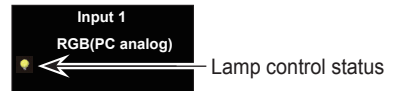

(See page 61 for Lamp control status.)

✓ **Note:**

- The Lamp replacement icon and the Filter replacement or the Filter cartridge replacement icon may appear on the screen depending on the usage state of the projector.
- When the filter cartridge replacement icon keeps appearing on the screen at turning on the projector for some time and no action is taken to replace the filter cartridge, the projector will be automatically shut down in 3 minutes after turning on to protect the projector. (pp. 71-73, 87)
- When the Picture in Picture function is set to **User 1-5**, User 1-5, Input source, Lamp control status, Lamp replacement icon and Filter warning icon will appear on the screen for 10 seconds.

PIN Code Input Dialog Box

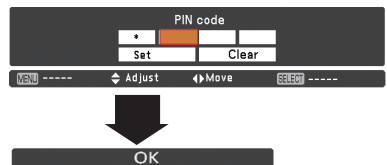

After the OK icon disappears, you can operate the projector.

✓ **Note:**

- If the PIN code number is not entered within three minutes after the PIN code dialog box appears, the projector will be turned off automatically.
- The "1234" is set as the initial PIN code at the factory.

What is PIN code?

PIN (Personal Identification Number) code is a security code that allows the person who knows it to operate the projector. Setting a PIN code prevents unauthorized use of the projector.

A PIN code consists of a four-digit number. Refer to the PIN code lock function in the Setting Menu on pages 65-66 for locking operation of the projector with your PIN code.



CAUTION ON HANDLING PIN CODE

If you forget your PIN code, the projector can no longer be started. Take a special care in setting a new PIN code; write down the number in a column on page 93 of this manual and keep it on hand. Should the PIN code be missing or forgotten, consult your dealer or service center.

Turning Off the Projector

- 1 Press the ON/STAND-BY button on the side control or the STAND-BY button on the remote control, and **Power off?** appears on the screen.
- 2 Press the ON/STAND-BY button on the side control or the STAND-BY button on the remote control again to turn off the projector. The LAMP/SHUTTER indicator lights bright and the POWER indicator turns off. After the projector is turned off, the cooling fans operate for 90 seconds. You cannot turn on the projector during this cooling down period.
- 3 When the projector has cooled down enough, the POWER indicator lights green and then you can turn on the projector. To unplug the AC power cord, wait until the projector is completely cooled down.

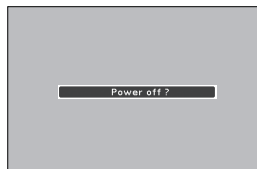

Power off? disappears after 4 seconds.



TO MAINTAIN THE LIFE OF THE LAMP, ONCE YOU TURN THE PROJECTOR ON, WAIT AT LEAST FIVE MINUTES BEFORE TURNING IT OFF.



DO NOT OPERATE THE PROJECTOR CONTINUOUSLY WITHOUT REST. CONTINUOUS USE MAY RESULT IN SHORTENING THE LAMP LIFE. TURN OFF THE PROJECTOR AND LET IT STAND FOR ABOUT AN HOUR IN EVERY 24 HOURS.

Direct OFF Function

You can disconnect the power cord from the wall outlet or turn off the breaker even during projection without pressing the ON/STAND-BY button.

✓ Note:

When using the Direct OFF function, you can not restart the projector immediately after the power is disconnected. If the external power supply is suddenly cut off, the fan stops immediately. The lamp remains high temperature and needs to be cooled.

✓ Note:

- When the Direct On function is set to **On**, the projector will be turned on automatically by connecting the AC power cord to an AC outlet (p.63).
- The running speed of cooling fans is changed according to the temperature inside the projector.
- Do not put the projector in a case before the projector is cooled enough.
- If the WARNING TEMP. indicator blinks red, see "Warning Indicators" on page 77.
- The projector cannot be turned on during the cooling period with the POWER indicator turned off. You can turn it on again after the POWER indicator becomes green again.

How to Operate the On-Screen Menu

The projector can be adjusted or set via the On-Screen Menu. The menu has a hierarchical structure, with a main menu that is divided into submenus, which are further divided into other submenus. For each adjustment and setting procedure, refer to respective sections in this manual.

- 1 Press the MENU button on the side control or the remote control to display the On-Screen Menu.
- 2 Use the Point ▲▼ buttons to highlight or select a main menu item. Press the Point ► or the SELECT button to access the submenu items. (The selected item is highlighted in orange.)
- 3 Use the Point ▲▼ buttons to select the desired submenu item and press the SELECT button to set or access the selected item.
- 4 Use the Point ▲▼◀▶ buttons to adjust the setting or switch between each option and press the SELECT button to activate it and return to the submenu.
- 5 Press the Point ◀ button to return to the main menu. Press the MENU button to exit the On-Screen Menu.

Side Control

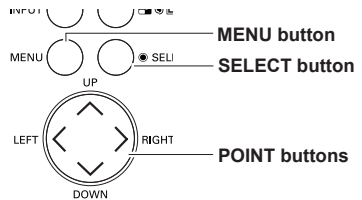

Remote Control

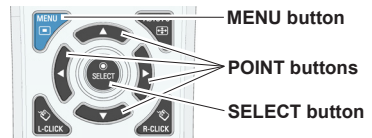

On-Screen Menu

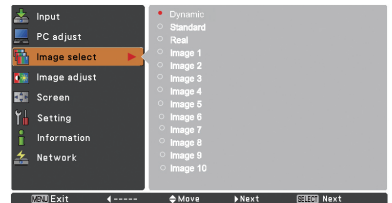

Point
► or SELECT
button

The currently set item is marked.

The selected item is highlighted in orange.

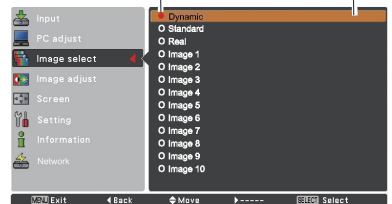

Main Menu

For detailed functions of each menu, see “Menu Tree” on pages 81-83.

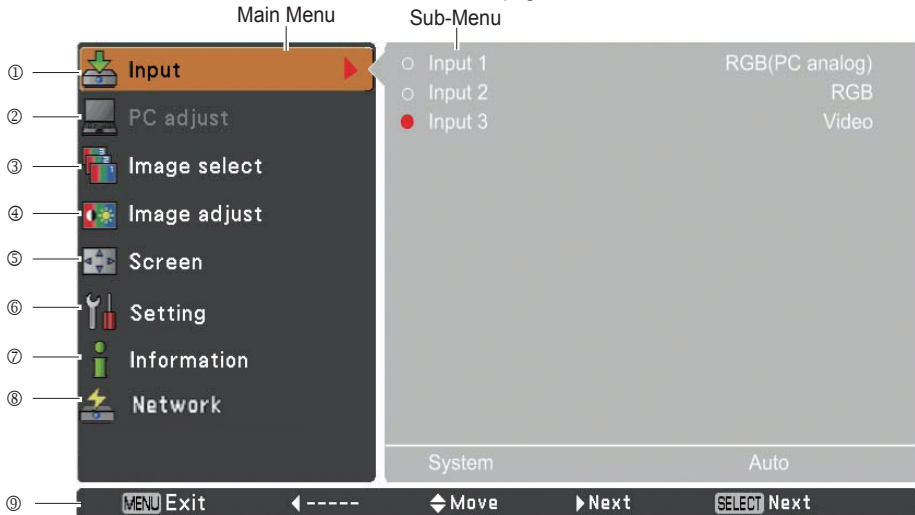

① Input

Used to select an input source (**Input 1**, **Input 2**, **Input 3** or **Network**) (p.32).

*Note: **Network** will not be displayed when optional Network unit is not attached.*

② PC adjust

Used to adjust the parameters to match with the input signal format (pp.36-38).

③ Image select

For computer source, used to select an image level among **Dynamic**, **Standard**, **Real**, and **Image 1-10** (p.39).

For Video source, used to select an image level among **Dynamic**, **Standard**, **Natural**, **Cinema**, and **Image 1-10** (p.47).

④ Image adjust

For computer source, used to adjust the computer image. [**Contrast/Brightness/Color management/Color temp./White balance (Red/Green/Blue)/Offset(Red/Green/Blue)/Auto picture control/Advanced color/Sharpness/Gamma/Reset/Store**] (pp.40-42).

For video or HDMI source, used to adjust the video image. [**Contrast/Brightness/Color/Tint/Color management/Color temp./White balance (Red/Green/Blue)/Offset (Red/Green/Blue)/Auto picture control/Advanced color/Sharpness/Gamma/Noise Reduction/Progressive/Reset/Store**] (pp.48-50).

⑤ Screen

For computer source, used to adjust the size of the image. [**Normal/Full/Wide(16:9)/Zoom/True/Custom/Custom adj./Digital zoom +/-/Keystone/Ceiling/Rear/Screen aspect/Reset**] (pp.43-45).

For video or HDMI source, used to adjust the size of the image. [**Normal/Full/Wide(16:9)/Zoom/Natural Wide/Custom/Custom adj./Keystone/Ceiling/Rear/Screen aspect/Reset**] (pp. 51-52).

⑥ Setting

Used to set the projector's operating configurations (pp.53-71).

⑦ Information

Display the input source information: **Input**, **System**, **H-sync freq.**, **V-sync freq.**, **Screen**, **Language**, **Lamp status**, **Lamp counter**, **Filter counter**, **Power management**, **Key lock**, **PIN code lock**, **Shutter management**, **Simple mode**, **Remote control**, and **SERIAL NO.** (p.28).

⑧ Network

See the user manual of “Network Set-up and Operation”.

⑨ Guide

The key operation is displayed
<http://www.pureglare.com.au>

Operating with Projector Control

Lens Operation

The following lens operation can be made with the LENS button on the side control.

Press the LENS button to enter each lens operation mode. The selected adjustment display appears on the screen.

Zoom → Focus → Lens Shift →

Zoom Adjustment

Display **Zoom** on the screen. Use the Point ▲ ▼ buttons to zoom in and out the image.

Focus Adjustment

Display **Focus** on the screen. Use the Point ▲ ▼ buttons to adjust focus of the image.

Lens Shift Adjustment

Display **Lens shift** on the screen. Use the Point ◀ ▶ buttons to position the screen to the desired point without having picture distortion.

The screen can be moved up or down to 60 percent, or sideways up to 10 percent from the central axis of the lens shift.

Press and hold the LENS button for more than 5 seconds to return to the central position.

✓ **Note:**

- The arrow disappears at the maximum lens shift in each direction.
- The arrows turn red when the lens shift comes to the center position of the screen.

Shutter Function

Shutter function allows you to completely block out light to the screen. Press the SHUTTER button to close the shutter inside the projector. To open up the shutter, press the SHUTTER button again. Refer to p.67 for details of setting for the Shutter function.

✓ **Note:**

- The SHUTTER button on the side control and the remote control cannot be effective when Shutter Protection is **On** in the Setting menu. (p.67)
- The SHUTTER indicator on the projector's top lights blue when the shutter is closed. (pp.12, 85)
- The projector will shut down automatically when the set time on shutter management has passed. (p.67)
- The Power management function does not work when the shutter is closed. (p.63)

<http://www.pureglare.com.au>

Side Control

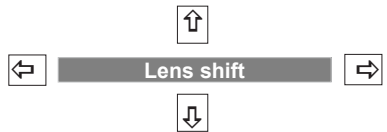
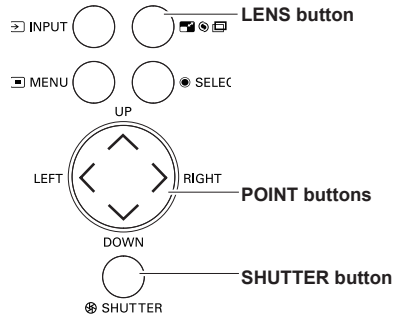

Operating with Remote Control

Using the remote control for some frequently used operations is advisable. Just pressing one of the buttons enables you to make the desired operation quickly without calling up the On-Screen Menu.

SHUTTER button

See pages 27, 67 for details.

IMAGE SEL. button

Press the IMAGE SEL. button on the remote control, the last stored image will be displayed on the screen for about 4 seconds. For its further functions, see pages 39 and 47 for details.

D.ZOOM button

Press the D.ZOOM button on the remote control to enter to the Digital zoom +/- mode. See page 44 for details.

LENS SHIFT button

See page 27 for details.

ZOOM buttons

Press the ZOOM buttons on the remote control to zoom in and out the image.

AUTO PC button

Press the AUTO PC button on the remote control to operate the Auto PC adj. function. The computer screen adjustment can be done easily by pressing this button. See page 36 for details.

SCREEN button

Press the SCREEN button on the remote control to select the desired screen size. The selected screen size symbol appears on the screen for 4 seconds. See pages 43-45 and 51-52 for details.

Press and hold the SCREEN button for more than 5 seconds to return all the screen size adjustment setting to the factory default setting.

INFO. button

Information display can be used to confirm the current operating condition of the projector and the signal being projected through the projector.

The information menu changes each time you press the INFO. button on the remote control as follows:

page 1/2 → page 2/2 → hide → page 1/2 →

While the information menu is displayed, press the Point ◀▶ buttons to display the previous or next page.

The information window can also be selected from the menu.

✓ Note:

- The H-sync freq. and V-sync freq. values described in the figure may be different from the actual values.
- SERIAL NO. is used to service the projector.

FOCUS buttons

Press the FOCUS buttons on the remote control to adjust focus of the image.

Remote Control

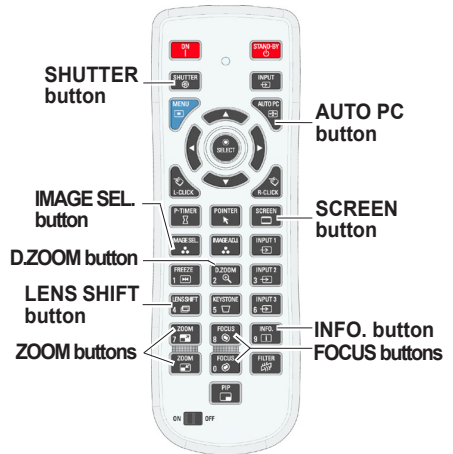

✓ Note:

See the next page for the description of other buttons.

Information Menu

Input	Input 1	RGB(PC analog)
PC adjust	System	WXGA1
Image select	H-sync freq.	48.4 KHz
Image adjust	V-sync freq.	80.0 Hz
Screen	Screen	Normal
Setting	Language	English
Information	Lamp status	▲
Network	Lamp counter	165 H
	Fairer counter	100 H
	Power management	Ready
		5 Min

1/2

Key lock	Key lock	☑
Shutter management	Shutter management	180 Min
Protection	Protection	☑
Release key	Release key	Any
Simple mode	Simple mode	On
Remote control	Remote control	Codes1
SERIAL NO.	SERIAL NO.	G7802377

2/2

MOUSE POINTER button

Move the pointer on the screen with this button.

POINTER button

Press POINTER button on the remote control to display the Pointer on the screen. (see pages 31, 64)

P-TIMER button

Press the P-TIMER button on the remote control to operate the Count up/Count down function. See page 64 for details of Setting for the P-timer function.

To stop the count time, press the P-TIMER button. To cancel the P-timer function, press and hold the P-TIMER button for a few seconds.

IMAGE ADJ. button

Press the IMAGE ADJ. button on the remote control to display the On-Screen Menu of Image Adjustment. See pages 40-42 and 48-50 for details of its functions. To cancel its function, press the IMAGE ADJ. button directly over again.

FREEZE button

Press the FREEZE button on the remote control to freeze the picture on the screen. To cancel the FREEZE function, press the FREEZE button again or press any other button.

Fig.1 will appear when the Freeze function is working.

Fig.1



FILTER button

Press and hold the FILTER button for more than 5 seconds to operate electrically operated filter to replace the filter.

- ✓ **Note:**
- The filter cannot be rewound.
 - When the filter is replaced, the total accumulated time of the filter use is automatically set to 0.

PIP button

Press the PIP button on the remote control several times until the desired mode of Picture in Picture appears. Each user mode (User 1-5) appears only when it has stored data. Press and hold the PIP button for more than 3 seconds to display the setting dialog box of Picture in Picture. See pages 57-58 for details of Picture in Picture function.

<http://www.pureglare.com.au>

Remote Control

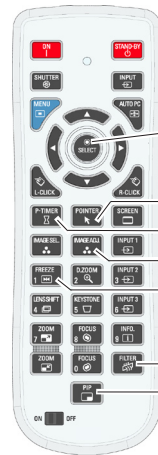

- MOUSE POINTER button
- POINTER button
- P-TIMER button
- IMAGE ADJ. button
- FREEZE button
- FILTER button
- PIP button

✓ **Note:**
See the previous page for the description of other buttons.

User 1 of PIP (example)



User 2 of PIP (example)

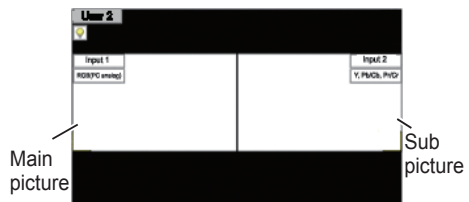

Keystone Correction

If a projected picture still has keystone distortion after pressing the AUTO PC button on the remote control, correct the image manually as follows:
 Press the KEYSTONE button on the remote control to switch the Standard (for Vertical/Horizontal) /Corner correction adjustment. The Standard or Corner correction adjustment dialog box appears. Use the Point ▲▼◀▶ buttons to correct the Standard or Corner distortion. The Standard or Corner correction adjustment can be stored (see pages 45, 52).

Remote Control

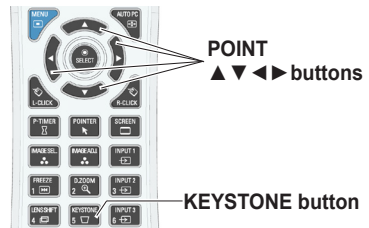

Standard



Reduce the lower width with the Point ▼ button. Reduce the upper width with the Point ▲ button.



Reduce the right part with Point ▶ button. Reduce the left part with Point ◀ button.



Corner correction



Press the KEYSTONE button on the remote control to switch Corner correction adjustment, press the SELECT button on the remote control to select the corner you want to adjust.

Reduce the top left corner part with the Point ▶▼ buttons. Reduce the top right corner part with the Point ◀▼ buttons.

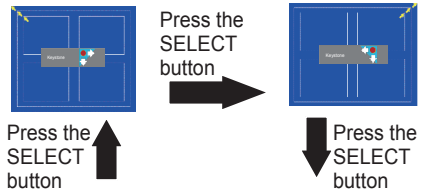

Reduce the bottom left corner part with the Point ▶▲ buttons. Reduce the bottom right corner part with the Point ◀▲ buttons.

✓ **Note:**

- The white arrows indicate that there is no correction.
- A red arrow indicates the direction of correction.
- An arrow disappears at the maximum correction.
- If you press and hold the KEYSTONE button for more than 3 seconds while the Standard or Corner correction dialog box is being displayed, the Standard or Corner correction adjustment will be released.
- The Corner pattern can be set to **Off**, **Red**, **White** or **Blue** in the Corner pattern function. See "Keystone" on pages 45, 52.
- The adjustable range is limited depending on the input signal.
- Standard and Corner correction functions cannot be adjusted at the same time. If one of the functions is adjusted, and then the other one will be reset automatically.

The top left corner adjustment as an example:

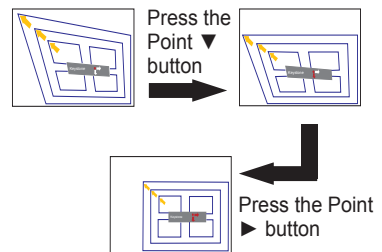

Pointer Function

You can move the Pointer of the projector with the remote control to emphasize a part of the projected image.

- 1 Press the POINTER button to activate the Pointer function.
- 2 Use the MOUSE POINTER button to move the Pointer.
- 3 To cancel the Pointer function, press the POINTER button again or press any other button.



MOUSE POINTER button

POINTER button

Dot

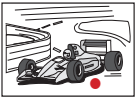

Arrow

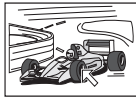

Finger

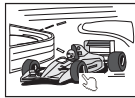

✓ **Note:**

You can choose the pattern of Pointer (**Dot/Arrow/Finger**) in the Setting Menu (p.64)

Wireless Mouse Operation

The remote control can be used as a wireless mouse for your computer.

- 1 Before operating the wireless mouse, connect your computer and the projector with a USB cable (p.20).
When the Pointer function is used, the wireless mouse is not available.
- 2 When a USB cable is connected to the computer and the projector, turn on the projector first, then the computer. If you turn on the computer first, the wireless mouse function may not operate properly.



L-CLICK button
Acts as left (click) mouse button while the projector and a computer are connected with a USB cable.

MOUSE POINTER button
Move the pointer on the screen with this button.

R-CLICK button
Acts as right (click) mouse button while the projector and a computer are connected with a USB cable.

Direct Operation

Side Control/Remote Control Operation

Side Control

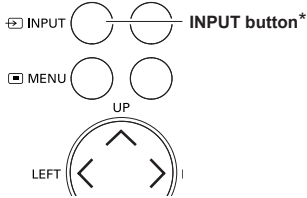

Remote Control

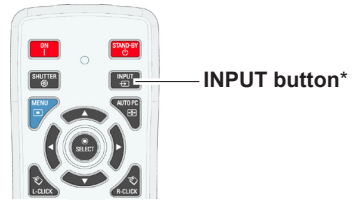

* Only the Input button function is set **Mode 1** in the Setting menu, the INPUT button is used for switching input source. (p.53)

The input source changes each time you press the INPUT button on the side control or the remote control as follows:

Input 1 → Input 2 → Input 3 → ...

Before using the INPUT button on the side control or the remote control, you must select a correct input source by On-Screen Menu and the latest input source will be displayed.

Remote Control Operation

Press the INPUT 1, INPUT 2, or INPUT 3 button on the remote control. The input source appears on the screen as you press each button. Select the connected input source.

INPUT 1 button

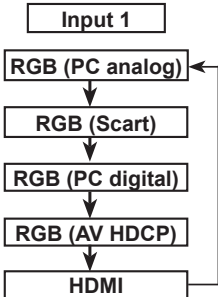

INPUT 2 button

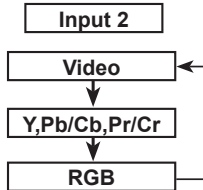

INPUT 3 button

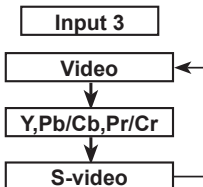

Remote Control

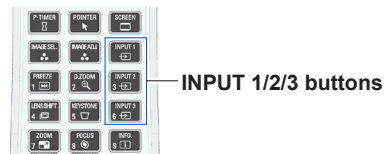

Computer Input Source Selection

Menu Operation

- 1 Press the MENU button to display the On-Screen Menu. Use the Point ▲▼ buttons to select **Input** and then press the Point ► or the SELECT button.
- 2 Use the Point ▲▼ buttons to select the desired input and then press the Point ► button to access the submenu items.
- 3 Use the Point ▲▼ buttons to select the desired source and then press the SELECT button.

WHEN SELECTING INPUT 1 (COMPUTER INPUT TERMINALS)

RGB(PC analog)

When your computer is connected to the INPUT 1 (ANALOG) terminal, select **RGB (PC analog)**.

✓ **Note:**
Input source changes if the INPUT 1 button on the remote control is pressed.

WHEN SELECTING INPUT 2 (5 BNC INPUT JACKS)

When connecting the computer output [5 BNC Type (Green, Blue, Red, Horiz. Sync, and Vert. Sync.)] from the computer to G, B, R, H/HV, and V jacks:

RGB

When your computer is connected to the INPUT 2 (5 BNC INPUT JACKS) terminal, select **RGB**.

INPUT MENU

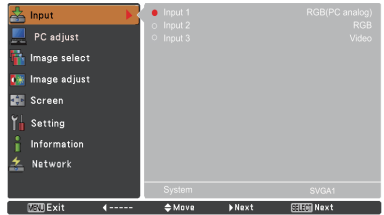

INPUT 1 MENU

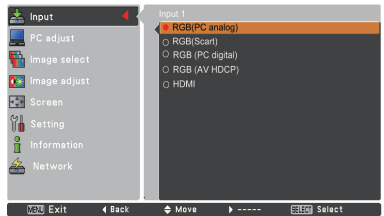

INPUT 2 MENU

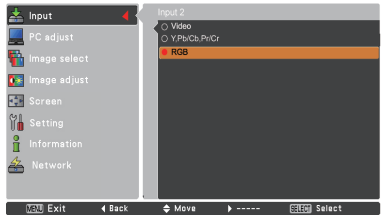

Video Input Source Selection

Menu Operation

- 1 Press the MENU button to display the On-Screen Menu. Use the Point ▲▼ buttons to select **Input** and then press the Point ► or the SELECT button.
- 2 Use the Point ▲▼ buttons to select the desired input and then press the Point ► button to access the submenu items.
- 3 Use the Point ▲▼ buttons to select the desired source and then press the SELECT button.

WHEN SELECTING INPUT 1 (COMPUTER INPUT TERMINALS)

When connecting to video equipment, select the type of Video source in the Source Select Menu.

RGB(Scart)

When scart video equipment is connected to the INPUT 1 (ANALOG) terminal, select **RGB (Scart)**.

HDMI

When the video signal is connected to the HDMI terminal, select **HDMI**.

RGB(AV HDCP)

If the HDCP-compatible signal source is connected to the INPUT 1 (DIGITAL) terminal, select **RGB (AV HDCP)**.

WHEN SELECTING INPUT 2 (5 BNC INPUT JACKS)

When connecting to video equipment, select the type of Video source in the Source Select Menu.

Video

When the video input signal is connected to the VIDEO jack, select **Video**.

Y,Pb/Cb,Pr/Cr

When the video input signal is connected to the Y-Pb/Cb-Pr/Cr jacks, select **Y,Pb/Cb,Pr/Cr**.

✓Note:

- When the video input signal is connected to the Y-Pb/Cb-Pr/Cr jacks, **Y,Pb/Cb,Pr/Cr** takes precedence of **RGB**.
- Y,Pb/Cb,Pr/Cr input can accept the component signal and the analog RGB signal. When analog RGB signal is not recognized in Y,Pb/Cb,Pr/Cr input source, set to **RGB** input manually.

WHEN SELECTING INPUT 3 (AV TERMINALS)

When connecting to video equipment, select the type of Video source in the Source Select Menu.

Video

When the video input signal is connected to the VIDEO jack, select **Video**.

Y,Pb/Cb,Pr/Cr

When the video input signal is connected to the Y-Pb/Cb-Pr/Cr jacks, select **Y,Pb/Cb,Pr/Cr**.

S-video

When the video input signal is connected to the S-VIDEO jack, select **S-video**.

<http://www.pureglare.com.au>

INPUT 1 MENU

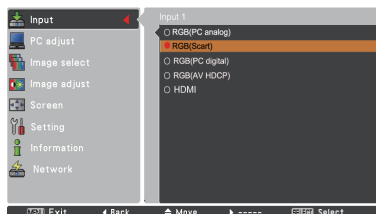

INPUT 2 MENU

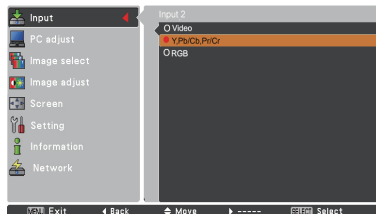

INPUT 3 MENU

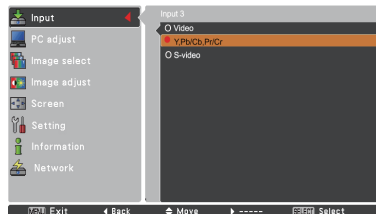

Computer System Selection

Automatic Multi-Scan System

This projector automatically tunes to various types of computers with its Multi-scan system and Auto PC adjustment. If a computer is selected as a signal source, this projector automatically detects the signal format and tunes to project a proper image without any additional settings. (Signal formats provided in this projector are shown on pages 88-89)

One of the following messages may appear when:

Auto When the projector cannot recognize the connected signal conforming to the provided PC Systems, **Auto** is displayed on the System Menu box and the Auto PC adjustment function works to display proper images. If the image is not projected properly, a manual adjustment is required (pp. 37-38).

----- There is no signal input from the computer. Check the connection between your computer and the projector. (See "Troubleshooting" on pp. 78-80.)

Mode 1 The preset system is manually adjusted in the PC adjust Menu. The adjusted data can be stored in **Mode 1-10** (pp.37-38).

SVGA 1 PC Systems provided in this projector is chosen. The projector chooses a proper system provided in the projector and displays it.

***Mode 1** and **SVGA 1** are examples.

PC System Menu



The PC System Menu Selected system is displayed.

Selecting Computer System Manually

PC system can also be selected manually.

- 1 Press the MENU button to display the On-Screen Menu. Use the Point ▲ ▼ buttons to select **Input** and then press the Point ► or the SELECT button.
- 2 Use the Point ▲ ▼ buttons to select **System** and then press the Point ► or the SELECT button.
- 3 Use the Point ▲ ▼ buttons to select the desired system and then press the SELECT button.

PC System Menu

Customized **Mode (1-10)** set in the PC adjust Menu (pp.37-38).

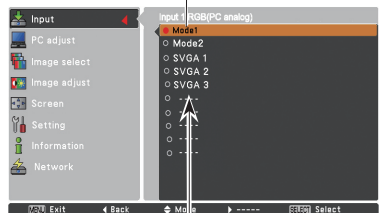

Systems in this dialog box can be selected.

Auto PC Adjustment

Auto PC Adjustment function is provided to automatically adjust Fine sync, Total dots, Position H and Position V to conform to your computer.

Direct Operation

The Auto PC adjustment function can be operated directly by pressing the AUTO PC button on the remote control.

Remote Control

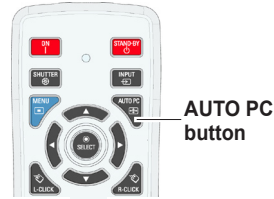

Menu Operation

Auto PC adj.

- 1 Press the MENU button to display the On-Screen Menu. Use the Point ▲ ▼ buttons to select **PC adjust** and then press the Point ► or the SELECT button.
- 2 Use the Point ▲ ▼ buttons to select **Auto PC adj.** and then press the SELECT button.

To store the adjusted parameters:

The adjusted parameters from the Auto PC Adjustment can be stored in the projector. Once the parameters are stored, the setting can be done just by selecting Mode in PC SYSTEM Menu (p.35). See "Manual PC Adjustment" on pages 37-38.

✓ **Note:**

- *Fine sync, Total dots, Position H and Position V of certain computers cannot be fully adjusted with the Auto PC Adjustment function. When the image is not provided properly with this operation, manual adjustments are required. (pp.37-38)*
- *The Auto PC adjustment cannot be operated when **480i, 575i, 480p, 575p, 720p, 1035i, 1080i or 1080p** is selected in the PC System Menu (p.35), or when the signal is coming from the HDMI or DVI-D terminal.*
- *Depending on the condition of signals and the type and length of cables, the signals may not be properly viewed.*

PC adjust Menu

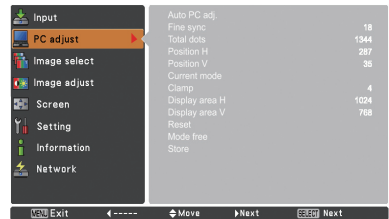

Use the Point ▲ ▼ buttons to select **Auto PC adj.** and press the SELECT button.
Please wait... appears while the Auto PC adjustment is in process.

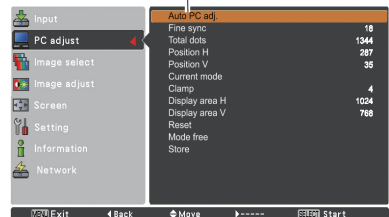

Manual PC Adjustment

Some computers employ special signal formats which may not be tuned by Multi-Scan system of this projector. Manual PC Adjustment enables you to precisely adjust several parameters to match those special signal formats. The projector has 10 independent memory areas to store those parameters manually adjusted. It allows you to recall the setting for a specific computer.

- 1 Press the MENU button to display the On-Screen Menu. Use the Point ▲▼ buttons to select **PC adjust** and then press the Point ► or the SELECT button.
- 2 Use the Point ▲▼ buttons to select the desired item and then press the SELECT button to display the adjustment dialog box. Use the Point ◀▶ buttons to adjust the setting value.

Fine sync

Use the Point ◀▶ buttons to adjust the value, eliminating a flicker from the image displayed (from 0 to 31).

Total dots

Use the Point ◀▶ buttons to adjust the number of total dots in one horizontal period to match your PC image.

Position H

Use the Point ◀▶ buttons to adjust the horizontal picture position.

Position V

Use the Point ◀▶ buttons to adjust the vertical picture position.

Current mode

Press the SELECT button to show H-sync freq. and V-sync freq. of the connected computer.

Clamp

Use the Point ◀▶ buttons to adjust the clamp level. When the image has dark bars, try this adjustment.

Display area H

Use the Point ◀▶ buttons to adjust the horizontal area displayed by this projector.

Display area V

Use the Point ◀▶ buttons to adjust the vertical area displayed by this projector.

PC adjust Menu

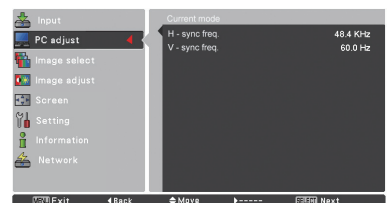
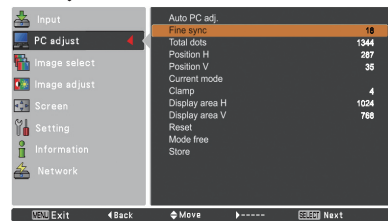
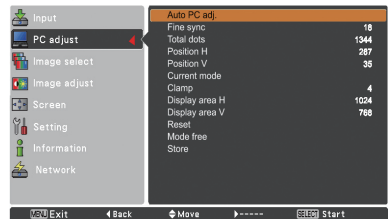
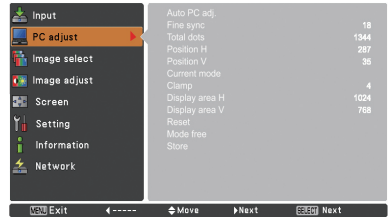

Reset

To reset the adjusted data, select **Reset** and press the SELECT button. A confirmation box appears and then select **Yes**. All adjustments will return to their previous figures.

Mode free

To clear the stored data, select **Mode free** and then press the Point ► or the SELECT button. Move the highlight to the Mode that you want to clear and then press the SELECT button.

Store

To store the adjusted data, select **Store** and then press the Point ► or the SELECT button. Move the highlight to one of the Modes 1 to 10 in which you want to store, and then press the SELECT button.

Mode free

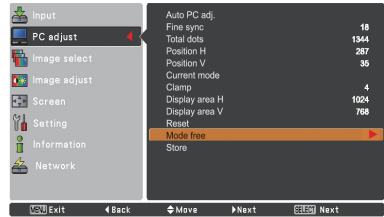

This mode has stored parameters.

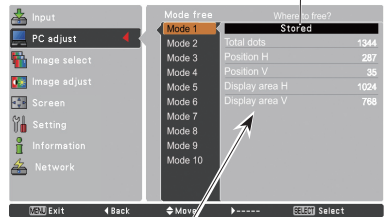

Values of **Total dots**, **Position H**, **Position V**, **Display area H** and **Display area V**.

Press the SELECT button to clear the stored data.

Store

Vacant

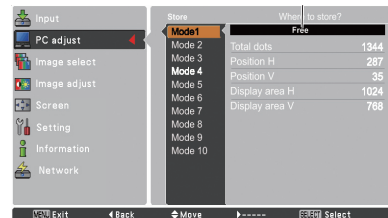

Press the MENU button to close this dialog box.

Press the SELECT button to store the data.

✓ Note:

- **Display area (H/V)** cannot be selected when **480i**, **575i**, **480p**, **575p**, **720p**, **1035i**, **1080i** or **1080p** is selected in the PC System Menu (p.35).
- When input computer signal to the projector, PC adjust function will become available.
<http://www.pureglare.com.au>

Image Level Selection

Direct Operation

The Image Selection function can be operated directly by pressing the IMAGE SEL. button on the remote control. the last stored image will be displayed on the screen for about 4 seconds.



Menu Operation

- 1 Press the MENU button to display the On-Screen Menu. Use the Point ▲▼ buttons to select **Image select** and then press the Point ► or the SELECT button. The factory default setting is Standard.
- 2 Use the Point ▲▼ buttons to select the desired item and then press the SELECT button.

* The factory default setting is Standard.

Dynamic

For viewing pictures in a bright room.

Standard

Normal picture level preset on the projector.

Real

Picture level with improved halftone for graphics.

Image 1-10

User preset picture adjustment in the Image adjust Menu. (pp.40-42)

Image select Menu

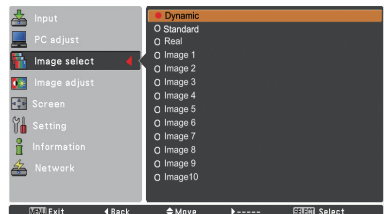
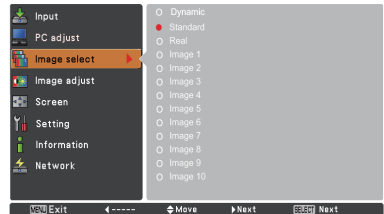

Image Adjustment

- 1 Press the MENU button to display the On-Screen Menu. Use the Point ▲ ▼ buttons to select **Image adjust** and then press the Point ► or the SELECT button.
- 2 Use the Point ▲ ▼ buttons to select the desired item and then press the SELECT button to display the adjustment dialog box. Use the Point ◀ ▶ buttons to adjust the setting value.

Contrast

Press the Point ◀ button to decrease the contrast; press the Point ▶ button to increase the contrast (from 0 to 63).

Brightness

Press the Point ◀ button to decrease the brightness; press the Point ▶ button to increase the brightness (from 0 to 63).

Color management

The Color Management function can be used to adjust the LEVEL, PHASE, and GAMMA of the selected display colors (except for black, white, and gray) on the screen and replace these colors with other colors if required. You can store up to eight (8) color management data.

- 1 Select and highlight Color Management by using the Point ▲ ▼ buttons and press the SELECT button. The projected image freezes, and the COLOR MANAGEMENT POINTER appears.
- 2 Use the Point ▲ ▼ ◀ ▶ buttons to move the pointer to the spot where you want to adjust the color and then press the SELECT button. The COLOR SELECTION window appears, and the color in the center of the pointer is selected and you can adjust the color.
- 3 Use the Point ▲ ▼ ◀ ▶ buttons to adjust the LEVEL and PHASE of the color, and then press the SELECT button to confirm the setting. Then use the Point ▲ ▼ buttons to adjust the GAMMA for the color and press the SELECT button to accept the setting. After adjusting, press the SELECT button to go to the COLOR MANAGEMENT LIST.

COLOR SELECTION MODE

LIST

Go to the COLOR MANAGEMENT LIST.

COLOR M.

Return to the COLOR MANAGEMENT POINTER. (If you press the MENU button on the side control or the remote control, it returns to the COLOR MANAGEMENT POINTER and you will need to reselect and readjust the color.)

Image adjust Menu

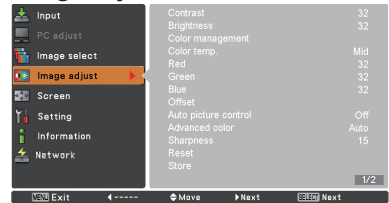

Selected Image mode

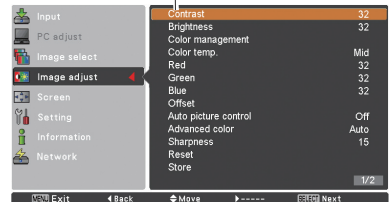

Use the Point ◀ ▶ buttons to adjust the setting value.



✓ Note:

When White balance Red, Green or Blue is adjusted, **Color temp.** will change to **Adj.**

POINTER MODE

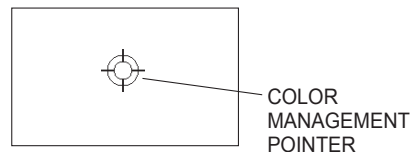

MENU

Return to the IMAGE ADJUST Menu. Any settings that have been changed will not be stored. To store the changed settings, be sure to select **LIST** and go to the COLOR MANAGEMENT LIST.

- 4 In the COLOR MANAGEMENT LIST, the adjusted color data are checkmarked. You can decide whether or not to apply the adjusted color data in the list to the projected image (see below).

LIST MODE



Clear the check mark if you do not want to apply the adjusted color data; select the check mark and then press the SELECT button. The check mark disappears.

COLOR PALETTE

Return to the COLOR SELECTION mode so that you can readjust the setting for the color in that line. (This option is not available if the check mark is cleared.)

DEL

Select the DEL box if you want to delete the adjusted data. Press the SELECT button and a confirmation box appears and then select **Yes**.

ALL DEL

Delete all the data in the list. Press the SELECT button and a confirmation box appears and then select **Yes**.

MENU

The same function as stated above.

COLOR M.

The same function as stated above.

COLOR SELECTION MODE

Level and phase adjustment palette. Gamma adjustment palette.

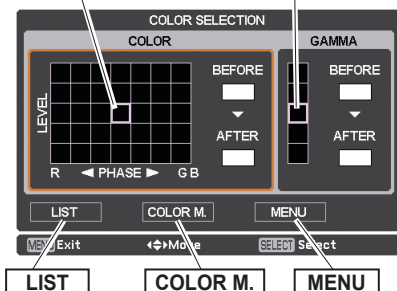

LIST MODE

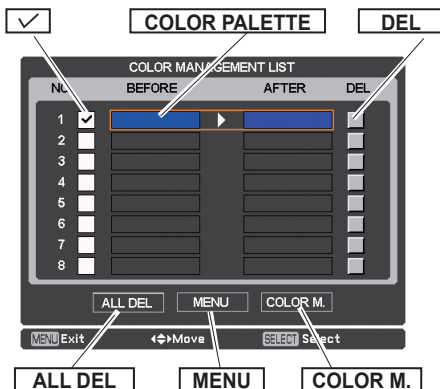

Color temp.

Use the Point ◀▶ buttons to select the desired Color temp. level (High, Mid, Low or XLow).

White balance (Red)

Press the Point ◀ button to lighten red tone; press the Point ▶ button to deepen red tone (from 0 to 63).

White balance (Green)

Press the Point ◀ button to lighten green tone; press the Point ▶ button to deepen green tone (from 0 to 63).

White balance (Blue)

Press the Point ◀ button to lighten blue tone; press the Point ▶ button to deepen blue tone (from 0 to 63).

Offset (Red/Green/Blue)

Press the Point ◀ button to lighten red/green/blue tone of the black level of an image; press the Point ▶ button to deepen red/green/blue tone of the black level of an image.

Auto picture control

Use the Point ◀▶ buttons to select the desired Auto picture control option (**Off**, **L1** or **L2**).

- Off**..... Auto picture control OFF position.
- L1**..... Auto picture control LEVEL 1 position.
- L2**..... Auto picture control LEVEL 2 position.

Advanced color*

Use the Point ◀▶ buttons to select the advanced color mode.

- Off**..... Advanced color mode is **Off**.
- Auto**..... Advanced color according to the type of image.

* This function controls the operation of the Color Control Devic, which independently and automatically regulates the amount of yellow light passing through the LCD panel, to accurately reproduce both image color and image brightness. Normally leave Auto (default setting).

✓ **Note:**

- *White balance may change depending on the image.*

Sharpness

Press the Point ◀ button to decrease the sharpness of the image; press the Point ▶ button to increase the sharpness of the image (from 0 to 31).

Gamma

Use the Point ◀▶ buttons to adjust the gamma value to obtain a better balance of contrast (from 0 to 15).

Reset

To reset the adjusted data, select **Reset** and press the SELECT button. A confirmation box appears and then select **Yes**. All adjustments will return to their previous figures.

Store

To store the adjusted data, select **Store** and press the Point ▶ or the SELECT button. Use the Point ▲▼ buttons to select one from Image 1 to 10 and press the SELECT button.

A confirmation box appears and then select **Yes**. Stored data can be called up by selecting an **Image (1-10)** in the Image Level Selection on page 39.

<http://www.pureglare.com.au>

Store

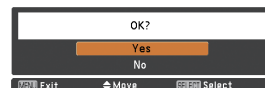
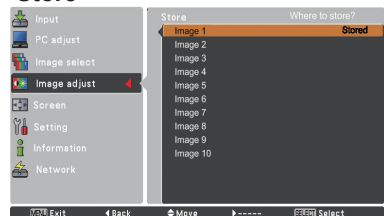

A confirmation box appears and then select **Yes**.

Screen Size Adjustment

Select the desired screen size that conforms to the input signal source.

- 1 Press the MENU button to display the On-Screen Menu. Use the Point ▲▼ buttons to select **Screen** and then press the Point ► or the SELECT button.
- 2 Use the Point ▲▼ buttons select the desired item and then press the SELECT button.

Normal

Provide the image within a screen size keeping its original aspect ratio.

Full

Provide the image to fit full screen size.

Wide (16:9)

Provide the image at the 16:9 wide screen ratio.

Zoom

Scale the image proportionally to fit the entire screen. Either side of image may go over the screen.

True

Provide the image in its original size. When the original image size is larger than the screen size (1920 x 1080), the projector goes to the panning mode automatically. Use the Point ▲▼◀▶ buttons to pan the image. When adjusted, the arrows will turn red. When reaching to the correction limits, the arrows will disappear.

Custom

Provide the last stored aspect screen image.

SCREEN MENU

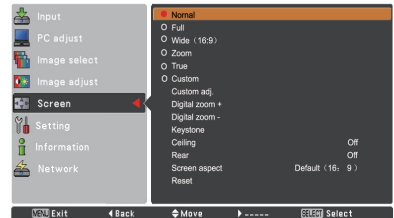
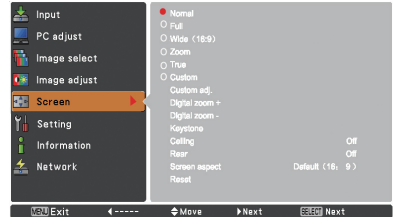

✓ Note:

- The projector cannot display any resolution higher than 1920 x 1200. If your computer's screen resolution is higher than 1920 x 1200, lower the resolution before connecting the projector.
- The image data other than 1920 x 1080 is modified to fit the screen size in initial mode.
- Full, Zoom, True, Custom adj. and Digital zoom +/- cannot be selected when no signal is detected in the PC System Menu. (p.35)

Custom adj.

Adjust the screen scale and position manually with this function.

Press the Point ► button or the SELECT button at **Custom adj.** and **Custom adj.** is displayed on the screen, you can use the Point ▲ ▼ buttons to choose the item you want to adjust.

- Scale H/V** Adjust the Horizontal/Vertical screen scale.
- H&V** When set to **On**, the aspect ratio is fixed. **Scale V** appears dim and becomes unavailable. Adjust **Scale H**, and then the screen scale is automatically modified based on the aspect ratio.
- Position H/V** ... Adjust the Horizontal/Vertical screen position.
- Common** Save the adjusted scale to all the inputs. Press the SELECT button at **Common** to display a confirmation box. To save the scale, press the SELECT button at **Yes**. When **Custom** is selected, the saved scale is used.
- Reset** Reset all the adjusted values. Press the SELECT button at **Reset** to display a confirmation box. To reset, press the SELECT button at **Yes**.

Custom adj.

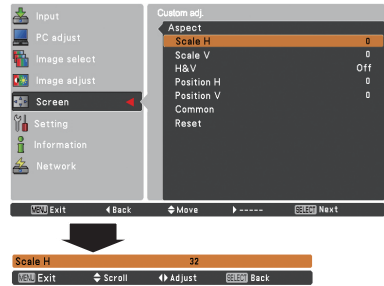

✓ Note:

- When no signal is detected, **Normal** is set automatically and the **Aspect** dialog box disappears.
- The adjustable range for **Scale H/V** and **Position H/V** is limited depending on the input signal.

Digital zoom +

Select **Digital zoom +**. The On-Screen Menu disappears and **D. zoom +** appears. Press the SELECT button to expand the image size. Use the Point ▲ ▼ ◀ ▶ buttons to pan the image. The Panning function can work only when the image is larger than the screen size.

You can also enter the Digital zoom + mode by pressing the D.ZOOM button on the remote control.

Digital zoom -

Select **Digital zoom -**. The On-Screen Menu disappears and **D. zoom -** appears. Press the SELECT button to compress image size.

The projected image can be also compressed by pressing the D.ZOOM button on the remote control.

You can also enter the Digital zoom - mode by pressing the D.ZOOM button on the remote control.

To return to the previous screen size, select a screen size from the Screen Size Adjustment Menu or select an input source from the Input Source Selection Menu (see pages 32-34) again or adjust the screen size with the D.ZOOM button.

<http://www.pureglare.com.au>

✓ Note:

- The panning function may not operate properly if the stored Mode in the PC adjust Menu is used (p.38).
- The minimum compression ratio is limited depending on the input signal, when the Keystone function is working or when the custom is selected for the screen size.
- **True** and **Digital zoom +/-** cannot be selected when **480i**, **575i**, **480p** or **575p** is selected in the PC System Menu (p.35).
- **Digital zoom +/-** cannot be selected when **True** is selected.
- **Digital zoom -** cannot be operated when **Custom** is selected.

Keystone

This function is used to adjust keystone distortion of the projected image. Use the Point ▲ ▼ buttons to choose the item you want to adjust.

Standard

Adjust the Horizontal/Vertical keystone distortion of the projected image.

Corner correction

Adjust the corner distortion of the projected image.

Corner pattern

Choose a Corner pattern mode among **Red**, **White**, **Blue**, and **Off**.

Store

Store Keep the keystone correction even when the AC power cord is unplugged.

Reset.... Release the keystone correction when the AC power cord is unplugged.

Press the KEYSTONE button on the remote control to switch the Standard (for Vertical/Horizontal) / Corner correction adjustment. The Standard or Corner correction adjustment dialog box appears. Use the Point ▲ ▼ ◀ ▶ buttons to correct the Standard or Corner distortion (p.30).

Keystone

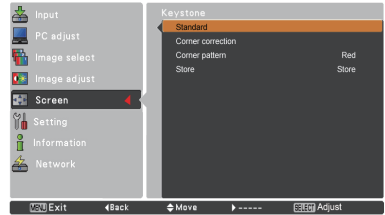

Ceiling

When this function is set to **On**, the picture will be top/ bottom and left/right reversed. This function is used to project the image from a ceiling-mounted projector.

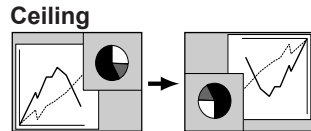

Rear

When this function is set to **On**, the picture will be left/right reversed. This function is used to project the image from rear of the screen.

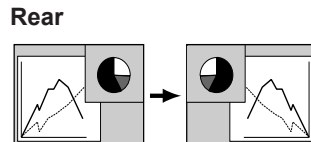

Screen aspect

This function is used to project the image to a 4:3 or 16:10 projection screen.

- Default (16:9)**16:9 is the aspect of the LCD panel.
The original Screen Menu is available.
- 16:10** Set to a 16:10 projection screen.
- 4:3**Set to a 4:3 projection screen.

Reset

This function returns all adjusted values to the factory default settings. Press the SELECT button at **Reset** to display a confirmation box. To reset, press the SELECT button at **Yes**.

<http://www.pureglare.com.au>

✓ **Note:**

- **Natural wide** cannot be selected when **720p**, **1035i**, **1080i** or **1080p** is selected on AV System Menu (p.46).
- When the 16:9 function is selected, **Wide (16:9)** is not available in the PC and AV screen (pp.43, 51).
- When the 4:3 function is selected, **Natural wide** is not available in the AV screen (p.51).

Video System Selection

- 1 Press the MENU button to display the On-Screen Menu. Use the Point ▲▼ buttons to select **Input** and then press the Point ► or the SELECT button.
- 2 Use the Point ▲▼ buttons to select **System** and then press the Point ► or the SELECT button.
- 3 Use the Point ▲▼ buttons to select the desired system and then press the SELECT button.

Video Jack or S-video Jack

Auto

The projector automatically detects an incoming video system, and adjusts itself to optimize its performance. When Video System is **PAL-M** or **PAL-N**, select the system manually.

PAL/SECAM/NTSC/NTSC4.43/PAL-M/PAL-N

If the projector cannot reproduce proper video image, select a specific broadcast signal format from among **PAL**, **SECAM**, **NTSC**, **NTSC 4.43**, **PAL-M**, and **PAL-N**.

Y, Pb/Cb, Pr/Cr Jacks

Auto

The projector automatically detects an incoming video signal, and adjusts itself to optimize its performance. When the Video System is **1035i**, **1080i** or **1080p**, select the system manually.

Y, Pb/Cb, Pr/Cr SIGNAL FORMAT

If the projector cannot reproduce proper video image, select a specific component video signal format from among **480i**, **575i**, **480p**, **575p**, **720p**, **1035i**, **1080i**, and **1080p**.

✓ **Note:**

The AV System Menu cannot be selected when selecting **RGB (Scart)**.

AV System Menu (Video or S-video)

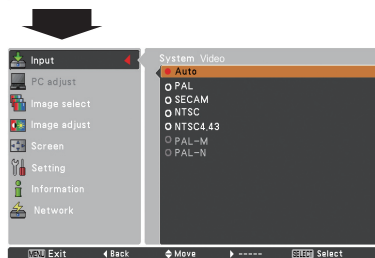

AV System Menu (Y, Pb/Cb, Pr/Cr)

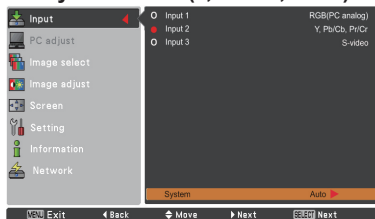

Image Level Selection

Direct Operation

The Image Selection function can be operated directly by pressing the IMAGE SEL. button on the remote control. the last stored image will be displayed on the screen for about 4 seconds.



Menu Operation

- 1 Press the MENU button to display the On-Screen Menu. Use the Point ▲ ▼ buttons to select **Image select** and then press the Point ► or the SELECT button.
- 2 Use the Point ▲ ▼ buttons to select the desired item and then press the SELECT button.

* The factory default setting is Standard.

Dynamic

For viewing pictures in a bright room.

Standard

Normal picture level preset on the projector.

Natural

Natural picture level preset on the projector.

Cinema

Picture level adjusted with fine tone.

Image 1–10

User preset picture adjustment in the Image adjust Menu. (p.48-50)

Image select Menu

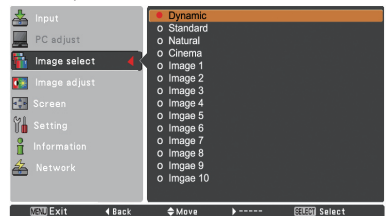
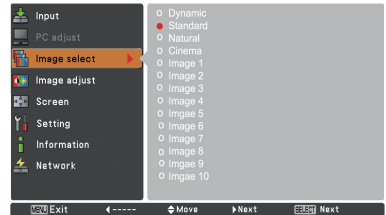

Image Adjustment

- 1 Press the MENU button to display the On-Screen Menu. Use the Point ▲▼ buttons to select **Image adjust** and then press the Point ► or the SELECT button.
- 2 Use the Point ▲▼ buttons to select the desired item and then press the SELECT button to display the adjustment dialog box. Use the Point ◀▶ buttons to adjust the setting value.

Contrast

Press the Point ◀ button to decrease the contrast; press the Point ► button to increase the contrast (from **0** to **63**).

Brightness

Press the Point ◀ button to decrease the brightness; press the Point ► button to increase the brightness (from **0** to **63**).

Color

Press the Point ◀ button to decrease the intensity of the color; press the Point ► button to increase the intensity of the color (from **0** to **63**).

Tint

Press the Point ◀▶ buttons to adjust the tint value to get a proper color balance (from **0** to **63**).

Color management

Refer to pages 40 and 41.

Color temp.

Use the Point ◀▶ buttons to select the desired Color temp. level (**High**, **Mid**, **Low** or **XLow**).

White balance (Red)

Press the Point ◀ button to lighten red tone; press the Point ► button to deepen red tone (from **0** to **63**).

White balance (Green)

Press the Point ◀ button to lighten green tone; press the Point ► button to deepen green tone (from **0** to **63**).

White balance (Blue)

Press the Point ◀ button to lighten blue tone; press the Point ► button to deepen blue tone (from **0** to **63**).

✓ Note:

- When White balance Red, Green or Blue is adjusted, the Color temp. level will change to **Adj.**
- Tint cannot be selected when the video system is **PAL**, **SECAM**, **PAL-M** or **PAL-N** (p.46).

Image adjust Menu

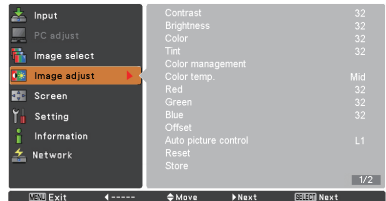

Selected Image mode

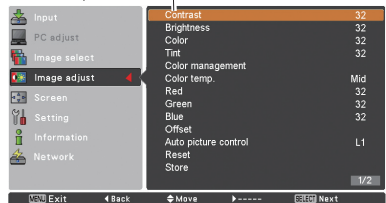

Use the Point ◀▶ buttons to adjust the setting value.



Offset (Red/Green/Blue)

Press the Point ◀ button to lighten red/green/blue tone of the black level of an image; press the Point ▶ button to deepen red/green/blue tone of the black level of an image (from 0 to 63).

Auto picture control

Use the Point ◀▶ buttons to select the desired Auto picture control option (Off, L1 or L2).

- Off..... Auto picture control OFF position.
- L1..... Auto picture control LEVEL 1 position.
- L2..... Auto picture control LEVEL 2 position.

Advanced color*

Use the Point ◀▶ buttons to select the advanced color mode.

- Off..... Advanced color mode is Off.
- Auto..... Advanced color according to the type of image.

* This function controls the operation of the Color Control Devic, which independently and automatically regulates the amount of yellow light passing through the LCD panel, to accurately reproduce both image color and image brightness. Normally leave Auto (default setting).

- ✓ **Note:**
 - White balance may change depending on the image.

Sharpness

Press the Point ◀ button to decrease the sharpness of the image; press the Point ▶ button to increase the sharpness of the image (from 0 to 31).

Gamma

Use the Point ◀▶ buttons to adjust the gamma value to obtain a better balance of contrast (from 0 to 15).

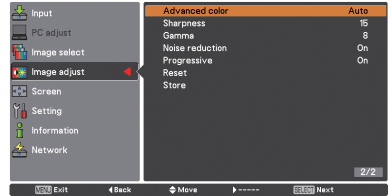

Noise reduction

Noise interference on the screen can be reduced. Press the Point ◀▶ buttons to change the noise reduction mode.

- Off**..... Noise reduction mode is **Off**.
- On**..... Noise reduction mode is **On**.

Progressive

An interlaced video signal can be displayed in progressive mode. Press the Point ◀▶ buttons to change the progressive scan mode.

- Off**..... Progressive scan mode is **Off**.
- On**..... Progressive scan mode is **On**.
- Film**..... For watching a film. With this function, the projector reproduces pictures faithful to the original film quality.

Reset

To reset the adjusted data, select **Reset** and press the SELECT button. A confirmation box appears and then select **Yes**. All adjustments will return to their previous figures.

Store

To store the adjusted data, select **Store** and press the Point ▶ or the SELECT button. Use the Point ▲▼ buttons to select one from Images 1 to 10 and press the SELECT button. A confirmation box appears and then select **Yes**. Stored data can be called up by selecting an **Image (1-10)** in the Image Mode Selection on page 47.

✓ **Note:**

- **Progressive** cannot be selected when **480p, 575p, 720p, or 1080p** is selected (p.46).
- **Noise reduction** cannot be selected with the computer input and when the video signal format is **1080p** (p.46).

Store

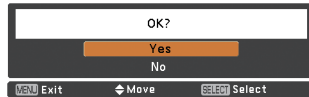

A confirmation box appears and then select **Yes**.

Screen Size Adjustment

- 1 Press the MENU button to display the On-Screen Menu. Use the Point ▲▼ buttons to select **Screen** and then press the Point ► or the SELECT button.
- 2 Use the Point ▲▼ buttons to select the desired item and then press the SELECT button.

Normal

Provide the image within a screen size keeping its original aspect ratio.

Full

Provide the image to fit full screen size.

Wide (16:9)

Provide the image at the 16:9 wide screen ratio.

Zoom

Scale the image proportionally to fit the entire screen. Either side of image may go over the screen.

Natural Wide

Expand the right and left side of images naturally without changing the center areas.

Custom

Provide the last stored aspect screen image.

Custom adj.

Adjust the screen scale and position manually with this function.

Press the **Point ►** button at **Custom adj.** and the Custom adjustment menu is displayed on the screen, you can use the Point ▲▼ buttons to choose the item you want to adjust.

Scale H/V Adjust the Horizontal/Vertical screen scale.

H&V.....When set to **On**, the aspect ratio is fixed. **Scale V** appears dimmed and becomes unavailable. Adjust **Scale H**, then the screen scale is automatically modified based on the aspect ratio.

Position H/V...Adjust the Horizontal/Vertical screen position.

Common.....Save the adjusted scale or position to all the inputs. Press the SELECT button at Common to display a confirmation box. To save the scale or position, press the SELECT button at "Yes". When Custom is selected, the saved scale or position is used.

Reset.....Reset all the adjusted values. Press the SELECT button at **Reset** to display a confirmation box. To reset, press the SELECT button at **Yes**.

<http://www.pureglare.com.au>

Custom adj.



✓ **Note:**

- When no signal is detected, **Normal** is set automatically and the Aspect dialog box disappears.
- The adjustable range for Scale H/V and Position H/V are limited depending on the input signal.
- **Natural wide** cannot be selected when **720p**, **1035i**, **1080i** or **1080p** is selected on AV System Menu (p.46).

Video Input

Keystone

This function is used to adjust keystone distortion of the projected image. Use the Point ▲ ▼ buttons to choose the item you want to adjust.

Standard

Adjust the Horizontal/Vertical keystone distortion of the projected image.

Corner correction

Adjust the corner distortion of the projected image.

Corner pattern

Choose a Corner pattern mode among **Red**, **White**, **Blue**, and **Off**.

Store

Store ... Keep the keystone correction even when the AC power cord is unplugged.

Reset... Release the keystone correction when the AC power cord is unplugged.

Press the KEYSTONE button on the remote control to switch the Standard (for Vertical/Horizontal) / Corner correction adjustment. The Standard or Corner correction adjustment dialog box appears. Use the Point ▲ ▼ ◀ ▶ buttons to correct the Standard or Corner distortion. (p.30)

Keystone

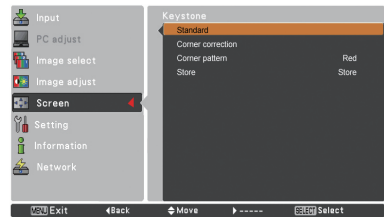

Ceiling

When this function is set to **On**, the picture will be top/ bottom and left/right reversed. This function is used to project the image from a ceiling-mounted projector.

Ceiling

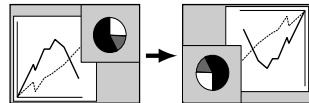

Rear

When this function is set to **On**, the picture will be left/right reversed. This function is used to project the image from rear of the screen.

Rear

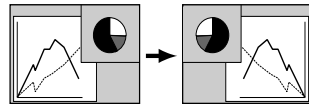

Screen aspect

This function is used to project the image to a 4:3 or 16:10 projection screen.

Default (16:9)16:9 is the aspect of the LCD panel. The original Screen Menu is available.

16:10 Set to a 16:10 projection screen.

4:3 Set to a 4:3 projection screen.

Reset

This function returns all adjusted values to the factory default settings. Press the SELECT button at **Reset** to display a confirmation box. To reset, press the SELECT button at **Yes**.

✓ Note:

- When the 16:9 function is selected, **Wide (16:9)** is not available in the PC and AV screen (pp.43, 51).
- When the 4:3 function is selected, **Natural wide** is not available in the AV screen (p.51).

Setting

This projector has a Setting menu that allows you to set up the other various functions described below.

- 1 Press the MENU button to display the On-Screen Menu. Press the Point ▲▼ buttons to select **Setting** and press the Point ► or the SELECT button to access the submenu items.
- 2 Use the Point ▲▼ buttons to select the desired item and then press the Point ► or the SELECT button to access the selected item.
- 3 Use the Point ▲▼ buttons to select the desired item and then press the SELECT button.

Language

The language used in the On-Screen Menu is available in English, German, French, Italian, Spanish, Portuguese, Dutch, Swedish, Russian, Chinese, Korean and Japanese.

Menu

Position

This function is used to adjust the On-Screen Menu display position. Press the SELECT button and the adjustment screen appears (arrows appear). Use the Point ▲▼◀▶ buttons to adjust the position. After making the adjustment, press the SELECT button to return to the Menu screen.

Menu size

This function is used to change the display size of the On-Screen Menu. Select **Menu size** and press the SELECT button.

Normal...Display the On-Screen Menu on the screen in its normal size.

Double...Display the On-Screen Menu on the screen in its double normal size. The on-screen menu is temporarily cleared while **Color Management** adjustment is in progress.

Input button

This function detects the input signal automatically. When a signal is found, the search will stop. Use the Point ▲▼ buttons to select one of the following options.

Mode 1..... Input search will not work.

Mode 2..... Input search works under the following situation:

- When pressing the INPUT button on the side control or the remote control.

Mode 3..... Input search works under the following situation:

- When turning on the projector by pressing the ON/STAND-BY button on the side control or pressing the ON button on the remote control.
- When pressing the INPUT button on the remote control or on the side control.

When no signal is detected.

<http://www.pureglare.com.au>

Setting Menu

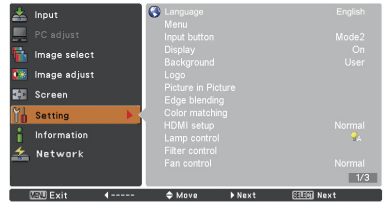

Language

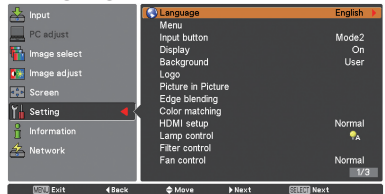

Position

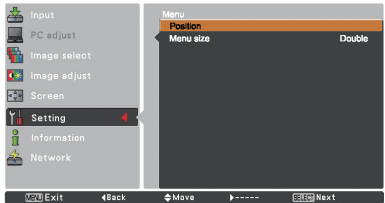

✓ Note:

- When the **4:3** function is selected in **Screen aspect**, **Double** is not available; it will be forced to return to **Normal** in **Menu size**.

✓ Note:

- While **Input button** is set to **Mode 3**, and no signal is detected, if the **Shutter** or **Freeze** function is active, cancel it to activate the **Input search**.
- Only the last selected input source can be detected.
- If the **INPUT**, **INPUT 1**, **INPUT 2**, **INPUT 3**, **ON / STAND-BY** or **MENU** button is pressed during **Input search** is in progress, **Input search** will stop and go back to the previous input signal.

Setting

Display

This function decides whether to display On-Screen Displays.

- On**..... Show all the On-Screen displays. Use this function when you want to project images after the lamp becomes bright enough. The factory default setting is in this option.
- Countdown Off**.... Show the input image instead of the countdown when turning on the projector. Use this function when you want to project the image as early as possible even when the lamp is not bright enough.
- Off** Hide the On-Screen Displays except:
 - **On-Screen Menu**
 - **Power off?** (p.24)
 - **No signal** for Power management. (p.62)
 - **Please wait ...**
 - **White Arrows** for panning mode (p.44)
 - **P-timer**
 - **Simple mode**
 - **Video delay control**
 - **Picture in Picture**
 - **Corner pattern**

Background

Select the background screen for when no input signal is detected. Press the Point ▲ ▼ buttons to switch among each option.

- Blue**.....Project a blue background.
- User**.....Project an image captured in the Logo setting. It is invalid when there is no image.
- Black**.....Project a black background.

Logo (Logo and Logo PIN code lock settings)

This function allows you to customize the screen logo with **Logo select**, **capture**, **Logo PIN code lock** and **Logo PIN code change** functions.

✓ **Note:**

When **On** is selected in the **Logo PIN code lock** function, **Logo select**, **Capture** and **Logo PIN code change** cannot be selected.

Logo select

This function decides on the starting-up display from among following options.

- Off** Show the countdown display only.
- User**..... Show the image you capture.
- Default** ... Show the factory-set logo.

<http://www.pureglare.com.au>

Logo select

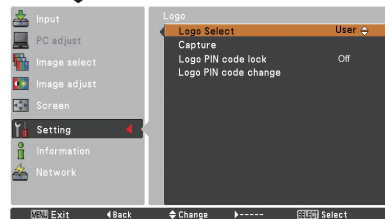
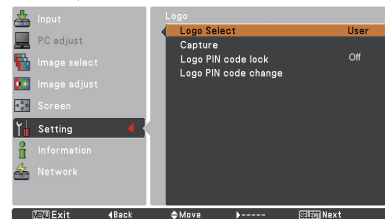
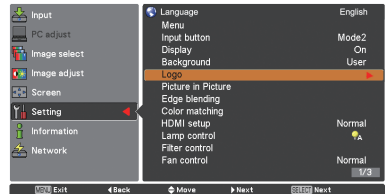

Capture

This function enables you to capture an image being projected to use it for a starting-up display or interval of presentations.

Select **Capture** and press the SELECT button. A confirmation box appears and select **Yes** to capture the projected image.

After capturing the projected image, go to the Logo select function and set it to **User**. Then the captured image will be displayed the next time you turn on the projector.

To cancel the capture function, select **Yes** in the "Quit?" confirmation box.

- ✓ **Note:**
 - Before capturing an image, select **Standard** in the Image Select Menu to capture a proper image (pp.39, 47).
 - A signal from a computer can be captured up to 1920 x 1080 dots.
 - When capturing the image that has been adjusted by the Keystone function, the adjusted data is automatically reset and the projector captures an image without keystone correction.
 - When **Logo PIN code lock** is set to **On**, **Capture** cannot be selected.
 - When starting to capture a new image, the previously stored image is cleared even if you cancel the capturing.
 - When there is no captured image or it is interrupted while capturing an image, **User** can not be selected, you can only switch between **Default** and **Off**.
 - Capture function is not available when the Picture in Picture function is set to **User 1-5**.

Capture

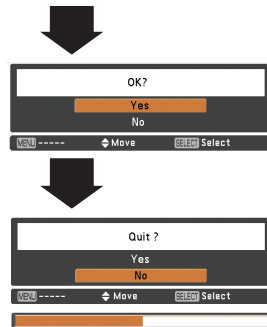
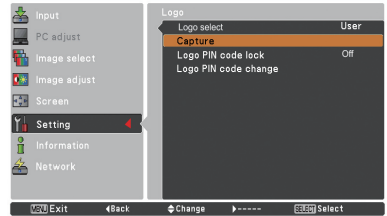

Logo PIN code lock

This function prevents an unauthorized person from changing the screen logo.

- On**..... The screen logo cannot be changed without a Logo PIN code.
- Off** The screen logo can be changed freely from the Logo Menu (p.54).

If you want to change the **Logo PIN code lock** setting, press the SELECT button and the Logo PIN code dialog box appears. Enter a Logo PIN code by following the steps below. The initial **Logo PIN code** is set to "4321" at the factory.

Logo PIN code lock

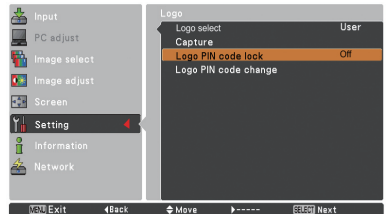

Enter a Logo PIN code

Use the Point ▲ ▼ buttons on the side control or Number buttons on the remote control to enter a number.

When using side control

Use the Point ▲ ▼ buttons on the side control to select a number. Press the Point ► button to fix the number and move the red frame pointer to the next box. The number changes to *. If you fix an incorrect number, use the Point ◀ button to move the pointer to the number you want to correct, and then enter the correct number.

Repeat this step to complete entering a four-digit number.

After entering the four-digit number, move the pointer to "Set". Press the SELECT button so that you can start to operate the projector.

When using remote control

Press the Number buttons on the remote control to enter a number (p.14). When you complete entering a four-digit number, the pointer moves to "Set". Press the SELECT button so that you can start to operate the projector.

If you enter an incorrect Logo PIN code, **Logo PIN code** and the number (****) will turn red for a moment. Enter the correct Logo PIN code all over again.

Change the Logo PIN code lock setting

Use the Point ▲ ▼ buttons to switch **On** or **Off**, and then press the SELECT button to close the dialog box.

Logo PIN code change

Logo PIN code can be changed to your desired four-digit number. Press the SELECT button to select Logo PIN code change. Current logo PIN code dialog box appears, use the Point ▲ ▼ buttons to enter the correct code. The New Logo PIN code input dialog box appears. Set a new Logo PIN code, confirmation box appears, choose Yes to set the new Logo PIN code.

Be sure to note the new Logo PIN code and keep it on hand. If you lost the number, you could no longer change the Logo PIN code setting.

CAUTION:

WHEN YOU HAVE CHANGED THE LOGO PIN CODE, WRITE DOWN THE NEW PIN CODE IN COLUMN OF THE LOGO PIN CODE NO. MEMO ON PAGE 93, AND KEEP IT SECURELY. SHOULD THE LOGO PIN CODE BE LOST OR FORGOTTEN, THE LOGO PIN CODE SETTING CAN NO LONGER BE CHANGED.

Enter a Logo PIN code



After a correct Logo PIN code is entered, the following dialog box appears.

Change the Logo PIN code lock setting

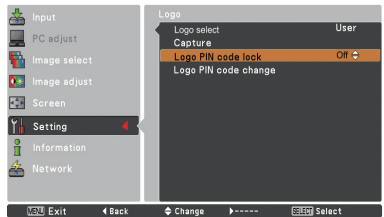

Change the Logo PIN code

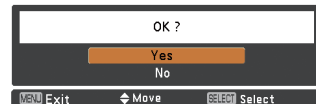
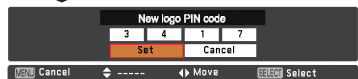
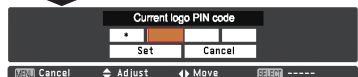
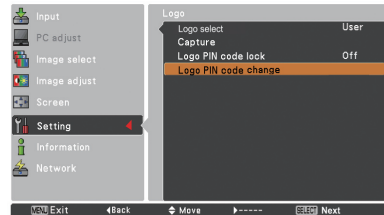

Picture in Picture

This function is used to project two images simultaneously by placing a separate small sub screen within or next to the main screen.

Use the Point ▲ ▼ buttons to select **Picture in Picture** and then press the SELECT button to display a dialog box. You can also display the dialog box by pressing and holding the PIP button on the remote control for more than 3 seconds. (In **P in P**, the larger picture is main picture, and the smaller one is sub picture; in **P by P**, the left picture is main picture, and the right one is sub picture.)

User setting

Show the selected mode (**Off/User 1-5**) and its status (**Stored /Free/ Adj.**). **User 1** and **User 2** have stored default values. See page 29 for details.

P in P/P by P

P in P: Provide the images of Main picture and Sub picture at the ratio of Screen aspect in the Screen Menu.

P by P: Provide the images of Main picture and Sub picture at the ratio of 4:3.

Main picture / Sub picture

- Input.....** Select an input from Input 1-3.
- Source...** Select an input source. The display varies depending on the selected input.
- Size.....** Select the display size. Main picture can be changed between 10 and 100%, and Sub picture can be changed between 10 to 50% in increments of 10%. When P by P is selected in Mode, the projection size is fixed to 50%.
- Position...** Press the SELECT button at Position and the display position setting screen appears.

Use the Point ▲ ▼ ◀ ▶ buttons to adjust the display position of active frame indicated in white. The frame will disappear after 10 seconds or when the SELECT button is pressed.

Selecting the Main picture or Sub picture

During Picture in Picture mode, and being undisplayed on Screen Menu, press the SELECT button to select Main or Sub picture. (A red frame will be displayed on the selected picture.)

Switching Input and Source

When selecting Main picture or Sub picture, input and source can be set by pressing the INPUT button on the side control or INPUT 1/2/3 button on the remote control. Operation on the On Screen Menu is not necessary.

Picture in Picture

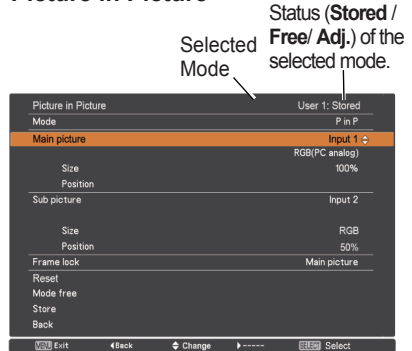

✓ **Note:**

- When **PIP** is selected, **screen is not available**.

Position Menu

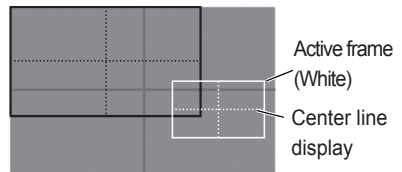

✓ **Note:**

- The **Picture in Picture** function is not available depending on the input signals and the selected input terminals. Refer to **List of Picture in Picture** for details. (p.95)
- When the input signal(s) is/are incompatible, **X** mark will be displayed for 10 seconds on the Main/Sub picture.

Frame lock

Set the Frame Lock to Main picture or Sub picture.

Reset

Press the SELECT button at **Reset** to display a confirmation box. To reset, press the SELECT button at **Yes**.

Mode free

Delete the data stored in the Mode and return to **Free**. Use the Point ▲▼ buttons to select **Mode free** and press the SELECT button to show the **Where to free?** dialog box. Move the highlight to one of the mode (**User 1 - 5**) which you want to delete and press the SELECT button. Then the confirmation box appears. To delete, select **Yes**.

Store

Store the adjusted data in the **User 1-5**. Use the Point ▲▼ buttons to select **Store** and press the SELECT button to show the **Where to store?** dialog box. Move the highlight to one of the mode (**User 1 - 5**) which you want to store and press the SELECT button. Then the confirmation box appears. To store adjusted data, select **Yes**.

To store the adjusted data.

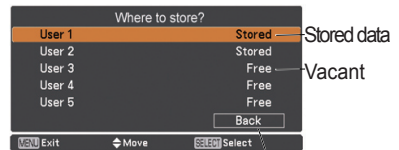

Return to Picture in Picture menu.

Edge blending

This function allows multiple projector images to be seamlessly overlapped.

Use the Point ▲▼ buttons to select Edge blending and then press the SELECT button to display a dialog box. Use the Point ▲▼◀▶ buttons to adjust the setting value.
On/Off Set to **On** to activate the Edge blending function.

Start The point at which edge blending starts. The edges of a green frame around an image shift in accordance with the values specified here. Specify a value in the 0 - 960 range for Left and Right and a value in the 0 - 540 for Top and Bottom.

Width..... Adjusts the width of correction.
 Right/Left: Set the width. (from 0 to 960).
 Top/Bottom: Set the width. (from 0 to 540).

Black level... Adjusts the black level of projected image.
 All: The values of R, G, and B will be changed simultaneously.

R/G/B: Adjusts the value (up to ± 127).
Test pattern . Select **On** to display a suitable pattern (white: 50%).

Menu off..... Closes the menu and hides all edge lines (in green, red, and gray) temporarily.

Reset..... Select **Reset** and press the SELECT button. Then Return to factory default of Edge Blending? message appears . To reset, press the SELECT button at **Yes**.

Back Hides the Edge blending setting menu and returns to the Setting menu.



Color matching

When displaying multiple screens, eliminates the difference in color between the images that are projected from the projectors.

When multiple sets are used simultaneously, this projector allows the user to correct the difference of colors among the sets.

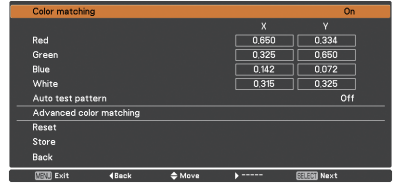

Use the Point ▲▼ buttons to select **Color matching** and then press the SELECT button to display a dialog box. Use the Point ▲▼◀▶ buttons to adjust the setting value.

Color matching Set to **On** to activate the Color matching function. When the color matching is set to **Off**, all items except for **Advanced color matching** and **Back** are displayed in grayout and cannot be adjusted.

Color adjustment .. Adjusts the color setting of Red/Green/Blue/White. The chromatic coordinate (X,Y) of Red, Green, Blue, and White can be adjusted respectively. The adjustable range is from 0.000 to 1.000.

Auto test pattern... Select **On** to display a suitable pattern when setting items.

Advanced color matching..... Select **Advanced color matching** and press the SELECT button for more detailed settings. Another setting screen will appear.

Reset..... Select **Reset** and press the SELECT button. Then the confirmation message appears. Press the SELECT button at Yes to reset to the previously stored values.

Store Select **Store** and press the SELECT button to display the Confirmation box. To store adjusted data, select **Yes**.

Advanced color matching

- Measured Information** When selecting **Measured Information**, the window shown right appears. Current image level is shown. To go back to the **Advanced color matting** window, press any key.
- Advanced color matching** Press the POINT ▲ ▼ buttons to switch between **On** and **Off**. Selecting **On** displays the values which link to the Color Match values.
- Measured** Displays the measured values of Red, Green, and Blue.
- Target** Adjusts the chromatic coordinate (X,Y) and the gain value (g) of Red, Green, Blue, Cyan, Magenta, Yellow, and White. Use the Point ▲ ▼ buttons to move the red frame pointer to an item of which you want to adjust the value and then press the SELECT button. Use the Point ▲ ▼ buttons to adjust the value. To move to the next digit, use the Point ▲ ▼ buttons. Press the SELECT button to set the value.
- Auto test pattern** Select **On** to display a suitable pattern when setting items.
- Menu off**..... Close the menu temporarily.
- Factory default**..... Select **Factory default** and press the SELECT button. Then Return to factory default of Color matching? message appears. To reset the selected Measured value and Target value, select **Yes**. Then, the confirmation box appears. Press the SELECT button at **Yes** again.
- Reset**..... Select **Reset** and press the SELECT button. Then the confirmation message appears. Press the SELECT button at **Yes**. to reset to the previously stored values.
- Store** Select **Store** and press the SELECT button. Then the Confirmation box appears. To store adjusted data, select **Yes**.
- Test pattern** Displays the **Test pattern** menu.
- Back**..... Cancels the **Advanced color matching** menu display.

Measured information

Measured information	
Dynamic	Default
Standard	Default
Real/Natural	Default
Cinema	Default

Advanced color matching

Advanced color matching		On
Measured		Information
Red	x 0.674 y 0.325	L 1.127
Green	x 0.386 y 0.690	L 0.818
Blue	x 0.141 y 0.070	L 0.069
Target		
Red	x 0.650 y 0.334	g 1.000
Green	x 0.326 y 0.650	g 1.000
Blue	x 0.142 y 0.072	g 1.000
Cyan	x 0.223 y 0.393	g 1.000
Magenta	x 0.302 y 0.164	g 1.000
Yellow	x 0.443 y 0.836	g 1.000
White	x 0.315 y 0.325	g 1.000
Auto test pattern		Off
Menu off		Test pattern
Factory default		Store Reset Back
Exit		Back Move Next

Test pattern

Test pattern	
Measured	Red
	Green
	Blue
Target	Red
	Green
	Blue
	Cyan
	Magenta
	Yellow
	White
	Exit

HDMI setup

Select **Normal** or **Enhanced** according to the output signal of video equipment. Press the Point ▲ ▼ buttons to switch between each option.

Normal When the output of video equipment is set to "STANDARD."

Enhanced When the output of video equipment is set to "ENHANCED."

<http://www.pureglare.com.au>

✓ Note:

- The names for the output setting of video equipment vary from equipment to equipment. For details, refer to the manual of video equipment.

Lamp control

Lamp control

This function allows you to change brightness of the screen.

- Ⓐ Auto Brightness according to the input signal.
- Ⓒ Normal . . Normal brightness.
- Ⓐ Eco 1 . . . Lower brightness and decrease of fan speed. Lower brightness reduces the lamp power consumption and extends the lamp life.
- Ⓑ Eco 2 . . . Lower brightness and increase of fan speed. Lower brightness reduces the lamp power consumption and extends the lamp life. It is recommended to use Eco 2 when using the projector continuously over a long period of time. The fan noise becomes louder in Eco 2 than in Eco 1. Select the suitable mode for the operating environment.

✓ **Note:**

The fan noise becomes louder in Eco 2 than in Eco 1. Select the suitable mode for the operating environment.

Filter control

You can replace the filter with this function. Press the SELECT button at **Filter control** to display a confirmation box. To replace, press the SELECT button at **Yes** and the electrically operated filter starts to scroll.

✓ **Note:**

- Filter replacement icon and **Please wait...** message appear on the screen when the filter is being scrolled.
- The filter cannot be rewind.
- When the filter is replaced, the total accumulated time of the filter use is automatically set to 0.
- Scrolling will be carried out even if the FILTER button on the remote control is pressed.

Fan control

Choose the running speed of cooling fans from the following options.

- Normal** .. Operate in this mode under normal conditions.
- Max**..... Use this mode when you want to increase the cooling effect when operating the projector in high ambient temperature environment. Fan noise is louder than **Normal**.

Filter control

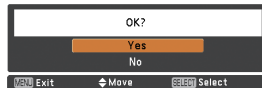
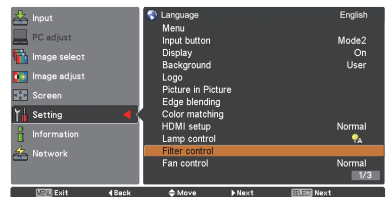

A confirmation box appears and then select **Yes**.

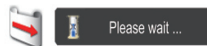

Simple mode

This function decides whether to activate the simple mode.

Off . . . Simple mode function is off.

On . . . Only the simple mode buttons are active.

✓ **Note:**

*Warning icon and **Simple mode : On** message appear on the screen for about 4 seconds when press the button which is not the simple mode button.*

Remote control

The eight different remote control codes (**Code 1- Code 8**) are assigned to the projector; the factory-set, initial code (**Code 1**) and the other seven codes (**Code 2 to Code 8**). The same code should be set on both the projector and the remote control. For example, operating the projector in **Code 7**, the remote control code also must be switched to **Code 7**.

To change the code for the projector:

Select a remote control code in this Setting Menu.

To change the code for the remote control:

Press and hold the MENU button and a number button (1-8) on the remote control for more than five seconds to switch among the codes. See "Remote Control Code" on page 16.

✓ **Note:**

- *When different codes are set on the projector and on the remote control, no operation can be made. In that case, switch the code on the remote control to fit the code on the projector.*
- *If the batteries are removed from the remote control for a long period of time, the remote control code will be reset.*

RC sensor

Select a location of the infrared remote receiver of the remote control. See "Remote Control Receivers and Operating Range" on page 15 for details.

Both Activate both the front and back receiver.

Front Activate only the front receiver.

Back Activate only the back receiver.

Simple mode buttons



Only these buttons are active when the simple mode is set to **On**. [ON, STAND-BY, SHUTTER, INPUT, MENU, AUTO PC, SCREEN, SELECT (Mouse Pointer included), L-CLICK, R-CLICK, P-TIMER, POINTER, PIP, ON-OFF switch] Number buttons (p. 14) also become active only when setting the remote control codes numbers or entering the PIN code numbers (pp. 56, 66).



Simple mode : On

Power management

For reducing power consumption as well as maintaining the lamp life, the Power management function turns off the projection lamp when the projector is not operated for a certain period.

Select one of the following options:

- Ready 1** When the lamp has been fully cooled down, the POWER indicator changes to green blinking. In this condition, the projection lamp will be turned on if the input signal is reconnected or any button on the side control or remote control is pressed.
- Ready 2** When 3 hours have elapsed since power management has been carried out, the lamp will turn off and the power will switch off. The operations during the initial 3 hours are the same as for **Ready 1**.
- Shut down** When the lamp has been fully cooled down, the power will be turned off.
- Off** Power management function is off.
- Timer** If the input signal is interrupted and no button is pressed for more than 30 seconds, the timer display with **No signal** appears. It starts the countdown until the lamp is turned off. Use the Point ▲▼ buttons to set the Timer (1~30 Min).

- ✓ **Note:**
 - Factory default is **OFF: 5 Min.**
 - When the shutter is closed while the Power management function is working, the Power management function is released.

Direct on

When this function is set to **On**, the projector will be automatically turned on just by connecting the AC power cord to the wall outlet.

- ✓ **Note:**

Be sure to turn off the projector properly (see "Turning Off the Projector" on page 24). If the projector is turned off in the incorrect sequence, the Direct on function does not work properly.

Power management



Timer left before Lamp is off.

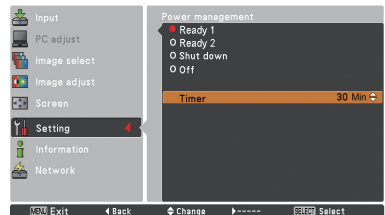
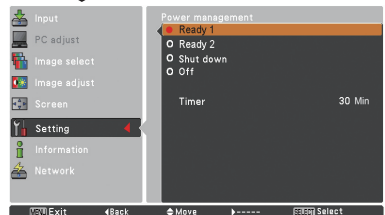
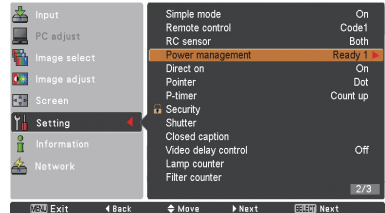

Pointer

You can emphasize a part of the projected image with this function. Use the Point ▲▼ buttons to select a pattern of the Pointer (Dot, Arrow or Finger). (p.31)

P-timer

This function allows you to change the presentation of the P-timer and execute it.

Select one of the following options:

Count up The P-timer display **000:00** appears on the screen and the count starts (**000:00–180:00**)

Count down The time set in the Timer setting appears on the screen and the countdown starts.

Timer Use the Point ▲▼ buttons to set the Timer (**1–180 Min**). Only set to **Count down**, **Timer** is active. Factory default value is **10 Min**.

Start It executes the count up or count down function. Press the SELECT button at **Start**, **Start** changes to **Stop** in the Screen Menu. At that time, press the SELECT button at **Stop** to stop **Count up** or **Count down**, and **Stop** changes to **Restart** in the Screen Menu. Press the SELECT button at **Restart** to resume **Count up** or **Count down**.

Reset Reset the P-timer values. Press the SELECT button at **Reset** to return to the following value;
Count up "000:00"
Count down ... Timer that you set.

Exit To exit the P-timer operation.

Stop or Cancel the P-timer via Remote Control

To stop the P-timer, press the P-TIMER button.
 To cancel the P-timer, press and hold the P-TIMER button for a few seconds.

P-TIMER



P-timer display.

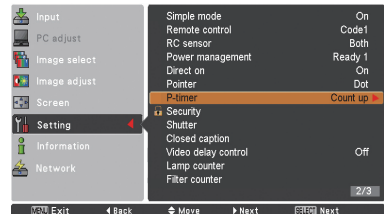

Security (Key lock and PIN code lock)

This function allows you to use the Key lock and PIN code lock function to set the security for the projector operation.

Key lock

This function locks the side control and remote control buttons to prevent operation by unauthorized persons.

 ...Unlocked.

 ...Lock the operation of the side control.
To unlock, use the remote control.

 ...Lock the operation of the remote control.
To unlock, use the side control.

If the side control accidentally becomes locked and you do not have the remote control nearby or there is something wrong with your remote control, contact the dealer where you purchased the projector or the service center.

PIN code lock

This function prevents the projector from being operated by unauthorized persons and provides the following setting options for security.

Off.....Unlocked.

On 1.....Enter the PIN code every time turning on the projector.

On 2.....Enter the PIN code to operate the projector once the power cord is disconnected; as long as the AC power cord is connected, the projector can be operated without a PIN code.

Whenever you change the PIN code lock setting or the PIN code (the four-digit number), you are required to enter the PIN code. The "1234" is set as the initial PIN code at the factory.

If you want to change the PIN code lock setting, Press the SELECT button and the PIN code dialog box appears.

Key lock

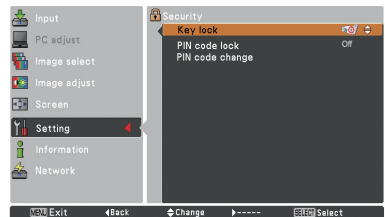
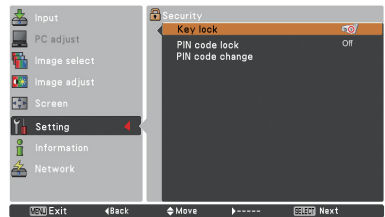
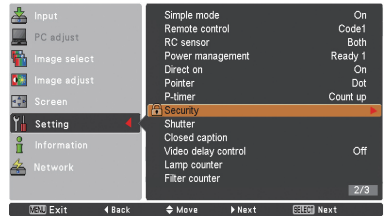

PIN code lock

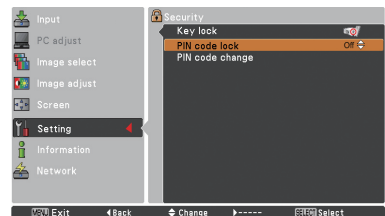

Enter a PIN code

Use the Point ▲ ▼ buttons on the side control or Number buttons on the remote control to enter a number.

When using side control

Use the Point ▲ ▼ buttons on the side control to select a number. Press the Point ► button to fix the number and move the red frame pointer to the next box. The number changes to *. If you fix an incorrect number, use the Point ◀ button to move the pointer to the number you want to correct, and then enter the correct number.

Repeat this step to complete entering a four-digit number.

After entering the four-digit number, move the pointer to **Set**. Press the SELECT button so that you can start to operate the projector.

When using remote control

Press the Number buttons on the remote control to enter a number (p.14). When you complete entering a four-digit number, the pointer moves to "Set". Press the SELECT button so that you can start to operate the projector.

If you enter an incorrect PIN code, **PIN code** and the number (****) will turn red for a moment. Enter the correct PIN code all over again.

Change the PIN code lock setting

Use the Point ▲ ▼ buttons to select **Off**, **On 1** or **On 2**. Press the SELECT button to close the dialog box.

PIN code change

The PIN code can be changed to your desired four-digit number. Press the Point ▼ button to select **PIN code change** and press the SELECT button. The Current PIN code dialog box appears. Use the Point ▲ ▼ buttons to set the current PIN code. The New PIN code dialog box appears. Set a new PIN code, the confirmation box appears, and choose **Yes** to set the new PIN code.

CAUTION:

WHEN YOU HAVE CHANGED THE PIN CODE, WRITE DOWN THE NEW PIN CODE IN COLUMN OF THE PIN CODE NO. MEMO ON PAGE 93, AND KEEP IT SECURELY. IF YOU FORGET YOUR PIN CODE, THE PROJECTOR CAN NO LONGER BE STARTED.

<http://www.pureglare.com.au>

Enter a PIN code

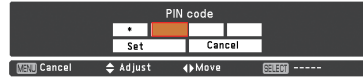

Change the PIN code

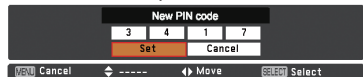
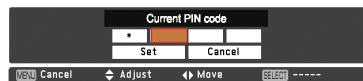
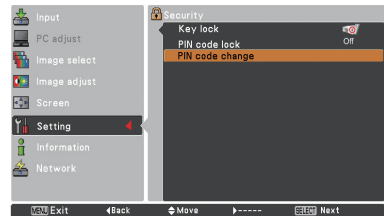



Shutter

Shutter function is available to block out light to the screen, so that the screen can be used for the other presenters.

Protection

Prohibit the shutter operation from the remote control and the projector's side control.

 Permit the shutter operation from both the remote control and the projector's side control.

 Prohibit the shutter operation from the remote control.

 Prohibit the shutter operation from the side control.

 Prohibit the shutter operation from both the remote control and the projector's side control.

Release key

By using the Release function from the following options, the Shutter can be released when it stays activated (i.e. when it is closed.)

AnyBy pressing any button on the projector's side control or the remote control, the shutter can be released when it is closed, and meanwhile the function of the selected item will come into effect.

SHUTTER... Only by pressing the SHUTTER button on the projector's side control or the remote control the shutter can be released when it is closed.

In addition, when the Shutter is functioning, only the following buttons are active:

- INPUT button and ON/STAND-BY button on the projector's side control
- INPUT 1/2/3 buttons and STAND-BY button on the remote control

Management

The Shutter Management function turns off the projection lamp when the projector is left with the shutter closed and the set time has passed away. The count-down time can be set between 5 and 480 minutes. When the count-down time has elapsed, the shutter will be opened up automatically and the lamp will be turned off to cool itself down. The LAMP/SHUTTER indicator is blinking blue during this cooling-off period. When the lamp has been fully cooled down, the POWER indicator turns green lighting and the LAMP/SHUTTER indicator keeps blinking. Should the ON / STAND-BY button be pressed in this condition, the projection lamp will be turned on and the LAMP/SHUTTER indicator turns off.

✓ **Note:**

The Shutter Management function cannot be halted.
<http://www.pureglare.com.au>

Shutter

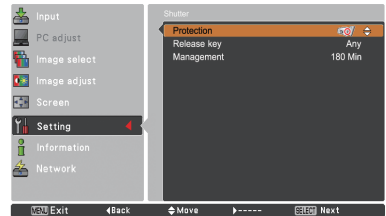
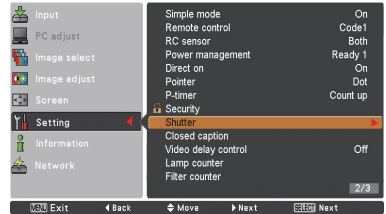

✓ **Note:**

When the shutter is closed, if the projector is turned off and on, the shutter will be released.

Closed caption

Closed caption is a printed version of the program sound or other information displayed on the screen. If the input signal contains Closed captions, you can turn on the feature and switch the channels. Press the Point ▲ ▼ buttons to select **Off**, **CC1**, **CC2**, **CC3** or **CC4**.

If the Closed caption is not clear, you can change the text from **Color** to **White**.

✓ Note:

The Closed caption is available only under the situation below.

- When the input signal is **NTSC** of composite and **S-video**, and the system is set according to the signal or set on **Auto**.
- The system must be set on **NTSC** or **Auto** in Video System Selection. (p.46)
- The item of Closed caption is displayed in gray while it is not available.
- **Closed caption** is unavailable when On-Screen Menu and P-timer are displayed.

Video delay control

When you want to make a digital processing of a projected image faster, set this function.

Use the Point ▲ ▼ buttons, select an item of **Off/Low/Mid/High**.

Digital processing speed becomes fast by order of Low → Mid → High. **High** is the fastest.

✓ Note:

-The following functions are not available respectively when Video delay control is set to **Low/Mid/High**.

Low ... Keystone can not be selected.

Mid ... Progressive and Noise reduction can not be selected.

High ... Keystone, Progressive and Noise reduction can not be selected.

-When Video delay control function is set to **Low** or **High** and press the **KEYSTONE** button on the remote control, Fig. 1 will be displayed on the bottom left screen about for 4 seconds.

<http://www.pureglare.com.au>

Closed caption

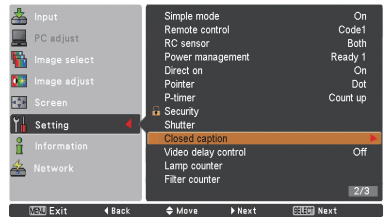

Press the Point ▲ ▼ buttons to select **Off**, **CC1**, **CC2**, **CC3** or **CC4**, and then Press **Select** button.

Fig.1



Video delay : On

Lamp counter

Be sure to reset the Lamp replacement counter after the lamp is replaced. (p. 65)

Press the Point ▲▼ buttons to choose the Lamp counter function and then press the Point ► or the SELECT button to access the submenu items.

Lamp counter This item shows the total accumulated time of the lamp usage.

Lamp counter reset Press the SELECT button to choose **Lamp counter reset**. Select **Yes** in the confirmation box if you want to reset the lamp counter, and then choose **Yes** in the second confirmation box to reset lamp counter.

Lamp counter reset

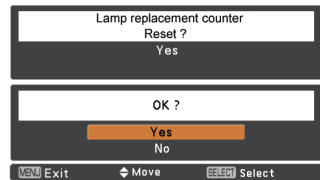
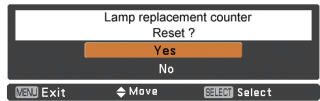
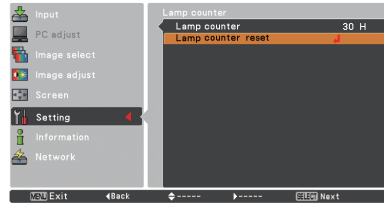

Filter counter

This function is used to set a frequency for the filter replacement.

Use the Point ▲▼ buttons to select **Filter counter** and then press the Point ► or the SELECT button to access the submenu items.

Filter counter..... Show the total accumulated time of the filter use timer setting.

Timer..... To set a timer, when the projector reaches the time, the Filter replacement icon (Fig.1) appears on the screen and the total accumulated time turns red, indicating that the filter replacement is necessary. If the filter is out of scroll and the projector reaches a time set in the timer setting, Fig.2 appears on the screen, indicating that the filter cartridge replacement is necessary.

Filter counter reset... When replacing the Filter cartridge, reset the Filter counter and the Scroll remaining (p.73).

Scrolls remaining... When the filter scroll is counted down to 1, Scroll remaining on the screen is showing **0 scroll(s)**, the last scroll icon (Fig.3) appears on the screen. When the filter scroll is counted down to 0, the Filter cartridge replacement icon (Fig.4) appears on the screen and the WARNING FILTER indicator lights orange, indicating that the filter cartridge replacement is necessary.

Scroll counter Reset... When replacing the Filter cartridge, reset the Filter counter and the Scroll remaining (p.73).

✓ **Note:**

- Do not reset the counter when the filter or the filter cartridge is not replaced.
- Timer setting notifies that the filter needs replacement. To replace the filter, use the filter control function (p.61).

Test pattern

Various test pattern are available for use when setting up the projector: Color, Gradation1-4, All white, All black and Cross.

Factory default

This function returns all setting values except for **User logo**, **PIN code lock**, **Logo PIN code lock** and **Filter counter** to the factory default settings.
<http://www.pureglare.com.au>

Filter counter



Press the SELECT button to select **Timer** and then use the Point ▲▼ buttons to set the timer. Select from (**Off/400H/700H/1000H**) depending on the operating environment.

✓ **Note:**

When the set time of Filter counter is not reached, Timer cannot be selected; while when the maximum time value 1000H is surpassed, 1000H can be selected again.

Fig.1 Filter replacement icon



Filter replacement icon appears on the screen at a set time.

Fig.2



Fig.3 Last scroll icon



Last scroll icon appears on the screen when the filter is down to the last scroll.

Fig.4 Filter cartridge replacement icon



Filter cartridge replacement icon appears on the screen when the filter scroll is counted down to 0 scroll.

✓ **Note:**

- Fig.1, Fig. 2, Fig. 3 and Fig. 4 appear at turning on and selecting input source.
- Fig.1, Fig. 2, Fig. 3 and Fig. 4 will not appear when the Display function is set to **Off** (p.54) or during "Freeze" (p.29).

Filter Instructions

Filter prevents dust from accumulating on the optical elements inside the projector. Should the filter becomes clogged with dust particles, it will reduce cooling fans' effectiveness and may result in internal heat buildup and adversely affect the life of the projector. This projector has an electrically operated filter which helps you to replace the filter easily. The projector monitors the condition of the filter at all time and replaces a filter with a new one automatically when it detects the clogging.

If the projector reaches a time set in the timer setting (p.70), a Filter replacement icon (Fig.1) appears on the screen and the WARNING FILTER indicator on the top panel lights up (p.87). When you see this icon, replace the filter as soon as possible (pp.29, 61). If the filter is out of scroll and the projector reaches a time set in the timer setting, Fig. 2 appears on the screen, indicating that the filter cartridge replacement is necessary.

When the filter scroll is counted down to 0, the Last scroll icon (Fig.3) appears on the screen, indicating that there is one scroll left in the filter cartridge (p.70).

If the projector detects that the filter is clogged and no scroll is left in the filter cartridge, a Filter cartridge replacement icon (Fig. 4) appears on the screen and the WARNING FILTER indicator on the top panel lights up (p.87). When you see this icon, replace the filter cartridge (p.72) and reset the Filter counter (p.73) and the Scroll counter (p.73).

When the filter is being scrolled using the remote control (p.29) or the Filter control function in the setting menu (p.61), a Filter replacement icon and **Please wait...** message (Fig.5) appear on the screen and the WARNING FILTER indicator blinks slow (approx. 2 seconds ON, 2 seconds OFF) (p.85).

The WARNING FILTER indicator blinks fast when the projector detects an abnormal condition, the filter cartridge is not installed properly, or the filter scroll is not working properly (p.87).

✓ **Note:**

- Fig. 1, Fig. 2, Fig. 3, Fig. 4 and Fig.5 will not appear when the Display function is set to **Off** (p.54) or during "Freeze" (p.29).
 - The filter cannot be rewound.
 - The filter can be scrolled 9 times since in the filter cartridge there are 10 scrolls in total.
 - The filter cartridge is disposable. Do not clean and reuse the filter cartridge.
 - Do not expose the filter cartridge to water or liquid, or it may cause a breakdown.
 - Replace the filter cartridge after all the scrolls are used up. If you replace the filter cartridge when there are some scrolls left in the filter cartridge, the filter counter and the scroll counter do not recognize the correct number of remaining scrolls and the reset function cannot work properly. It may cause a breakdown.
 - Do not use the filter cartridge with other projector.
- <http://www.pureglare.com.au>



Fig.1 Filter replacement icon



Fig.2



Fig.3 Last scroll icon



Fig.4 Filter cartridge replacement icon

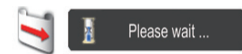



Fig.5 Filter replacement icon and **Please wait...** message.

The filter counter and the scroll counter do not recognize the correct number of remaining scrolls of the used filter cartridge and the reset function cannot work properly. It may cause a breakdown.

- Make sure that the projection lamp is turn off when you are replacing the filter cartridge. If you replace the filter cartridge when the projection lamp is turn on, the projector will be shut down automatically for safety purpose.
- Do not forget to reset the filter counter and the scroll counter in the setting menu after replacing the filter cartridge. If you forget to reset the filter counter and the scroll counter, the projector cannot recognize the correct number of remaining scrolls and may cause a breakdown.
- If you continue to use the projector without replacing the air filter cartridge and resetting the filter counter after the filter cartridge replacement icon is displayed, the power will switch off automatically approximately 10 hours after projection starts in order to protect the optical parts. After this, the power will switch off automatically 3 minutes after it is turned back on and projection starts.

Replacing the Filter Cartridge

- 1 Turn off the projector, and unplug the AC power cord from the AC outlet.
- 2 First, clean up the dust on the projector and around the air vents.
- 3 Press  on the filter cover to release the latch and open the filter cover.
- 4 Pull out the filter cartridge. When taking out the filter cartridge, put your finger on the filter cartridge's tab and then pull.
- 5 Put the new one back into the position and close the filter cover. Make sure that the filter cartridge is properly and fully inserted.
- 6 Connect the AC power cord to the projector and turn on the projector.
- 7 Reset the filter counter and the scroll counter (p.73).



CAUTION

Make sure the filter cartridge is inserted in the projector. If the filter cartridge is not inserted, the projector cannot be turned on. Do not put anything into the air vents. Doing so may result in malfunction of the projector.

RECOMMENDATION

We recommend avoiding dusty/smoky environments when operating the projector. Usage in these environments may cause a poor image quality.

When using the projector under dusty or smoky conditions, dust may accumulate on a lens, liquid crystal panels, or optical elements inside the projector. Such condition may degrade the quality of the projected image. When the symptoms above are noticed, contact your authorized dealer or service center for proper cleaning.

ORDER REPLACEMENT FILTER CARTRIDGE

Replacement filter cartridge can be ordered through your dealer. When ordering, give the following information to the dealer.

- **Model No. of your projector**
LHD700
- **Replacement Filter Cartridge Type No.**
003-003965-01 (Service Parts No. 610 342 9571)

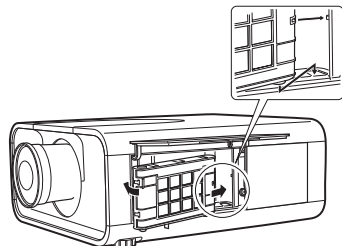
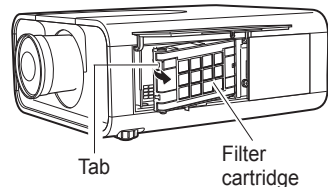
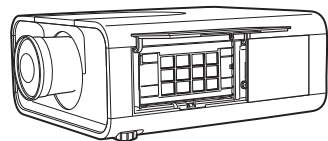
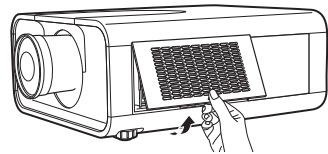
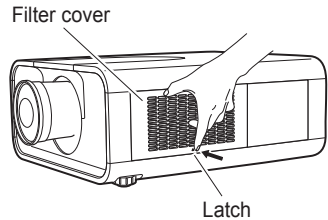

Resetting the Filter Counter

Be sure to reset the Filter counter after replacing the filter cartridge.

- 1 Press the MENU button to display the On-Screen Menu. Use the Point ▲▼ buttons to select **Setting** and then press the Point ► or the SELECT button.
- 2 Use the Point ▲▼ buttons to select **Filter counter** and then press the SELECT button. Use the Point ▲▼ buttons to select **Filter counter reset** and then press the SELECT button. **Filter counter Reset?** appears. Select **Yes** to continue.
- 3 Another confirmation dialog box appears, select **Yes** to reset the Filter counter.

Filter counter

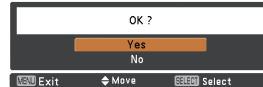
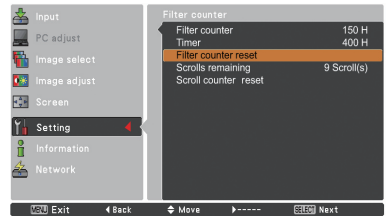

Filter counter Reset? appears.

Select **Yes**, then another confirmation box appears.

Select **Yes** again to reset the Filter counter.

Resetting the Scroll Counter

Be sure to reset the Scroll counter after replacing the filter cartridge.

- 1 Press the MENU button to display the On-Screen Menu. Use the Point ▲▼ buttons to select **Setting** and then press the Point ► or the SELECT button.
- 2 Use the Point ▲▼ buttons to select **Filter counter** and then press the SELECT button. Use the Point ▲▼ buttons to select **Scroll counter reset** and then press the SELECT button. **Scroll counter Reset?** appears. Select **Yes** to continue.
- 3 Another confirmation dialog box appears, select **Yes** to reset the Scroll counter.

Scroll counter

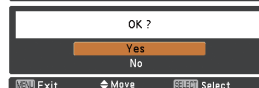

Scroll counter Reset? appears.

Select **Yes**, then another confirmation box appears.

Select **Yes** again to reset the Scroll counter.

Lamp Replacement

When the projection lamp of the projector reaches its end of life, the Lamp replacement icon appears on the screen and LAMP REPLACE indicator lights orange. Replace the lamp with a new one promptly. The timing when the LAMP REPLACE indicator should light is depending on the lamp mode.

Top Panel

LAMP / SHUTTER

LAMP REPLACE

WARNING FILTER

WARNING TEMP.



Lamp replacement icon

LAMP REPLACE indicator

✓ Note:

The Lamp replacement icon will not appear when the Display function is set to **Off** (p.54) or during "Freeze" (p.29)

Follow these steps to replace the lamp.

- 1 Turn off the projector and unplug the AC power cord. Let the projector cool for at least 45 minutes.
- 2 Open the filter cover (p.72).
- 3 Loosen the screw and open the lamp cover. Pull out the lamp by using the built in handle.
- 4 Replace the lamp with a new one. Make sure that the lamp is properly and fully inserted.
- 5 Close the lamp cover and secure the screw.
- 6 Close the filter cover.
- 7 Connect the AC power cord to the projector and turn on the projector.
- 8 Reset the Lamp counter (p.69).

✓ Note:

Be sure to insert the lamp in the correct direction.

CAUTION

When replacing the lamp because it has stopped illuminating, there is a possibility that the lamp may be broken. If replacing the lamp of a projector which has been installed on the ceiling, you should always assume that the lamp is broken, and you should stand to the side of the lamp cover, not underneath it. Remove the lamp cover gently. Small pieces of glass may fall out when the lamp cover is opened. If pieces of glass get into your eyes or mouth, seek medical advice immediately.

CAUTION

Allow a projector to cool for at least 45 minutes before you open the lamp cover. The inside of the projector can become very hot.

<http://www.pureglare.com.au>

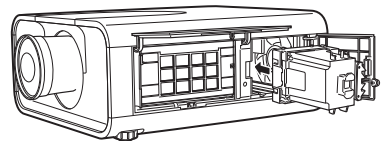
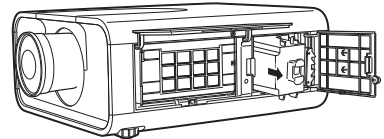
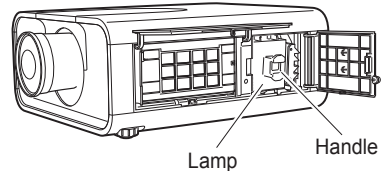
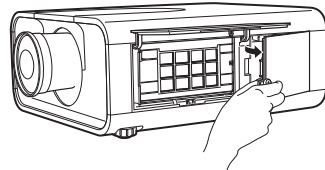
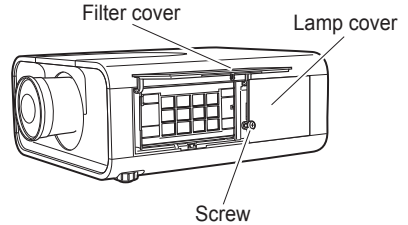

CAUTION

For continued safety, replace with a lamp of the same type. Do not drop the lamp or touch the glass bulb! The glass can shatter and may cause injury.



LAMP HANDLING PRECAUTIONS

This projector uses a high-pressure lamp which must be handled carefully and properly. Improper handling may result in accidents, injury, or create a fire hazard.

- Lamp lifetime may differ from lamp to lamp and according to the environment of use. There is no guarantee of the same lifetime for each lamp. Some lamps may fail or terminate their lifetime in a shorter period of time than other similar lamps.
- If the projector indicates that the lamp should be replaced, i.e., if the LAMP REPLACE indicator lights up, replace the lamp with a new one IMMEDIATELY after the projector has cooled down. (Follow carefully the instructions in the Lamp Replacement section of this manual.) Continuous use of the lamp with the LAMP REPLACE indicator lighted may increase the risk of lamp explosion.
- Lamp may explode as a result of vibration, shock or degradation as a result of hours of use as its lifetime draws to an end. Risk of explosion may differ according to the environment or conditions in which the projector and lamp are being used.

IF A LAMP EXPLODES, THE FOLLOWING SAFETY PRECAUTIONS SHOULD BE TAKEN.

If a lamp explodes, disconnect the projector's AC plug from the AC outlet immediately. Contact an authorized service center for a checkup of the unit and replacement of the lamp. Additionally, check carefully to ensure that there are no broken shards or pieces of glass around the projector or coming out from the cooling air circulation holes. Any broken shards found should be cleaned up carefully. No one should check the inside of the projector except those who are authorized trained technicians and who are familiar with projector service. Inappropriate attempts to service the unit by anyone, especially those who are not appropriately trained to do so, may result in an accident or injury caused by pieces of broken glass.

ORDER REPLACEMENT LAMP

Replacement lamp can be ordered through your dealer. When ordering, give the following information to the dealer.

- **Model No. of your projector** : LHD700
- **Replacement Lamp Type No.** : 003-120641-01
(Service Parts No.610 357 0464)

Cleaning the Projection Lens

Unplug the AC power cord before cleaning.

Gently wipe the projection lens with a cleaning cloth that contains a small amount of non-abrasive camera lens cleaner, or use a lens cleaning paper or commercially available air blower to clean the lens.

Avoid using an excessive amount of cleaner. Abrasive cleaners, solvents, or other harsh chemicals might scratch the surface of the lens.

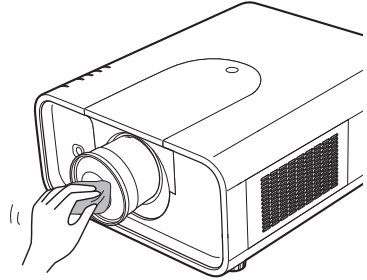

Cleaning the Projector Cabinet

Unplug the AC power cord before cleaning.

Gently wipe the projector body with a soft dry cleaning cloth. When the cabinet is heavily soiled, use a small amount of mild detergent and finish with a soft dry cleaning cloth. Avoid using an excessive amount of cleaner. Abrasive cleaners, solvents, or other harsh chemicals might scratch the surface of the cabinet.

When the projector is not in use, put the projector in an appropriate carrying case to protect from dust and scratches.

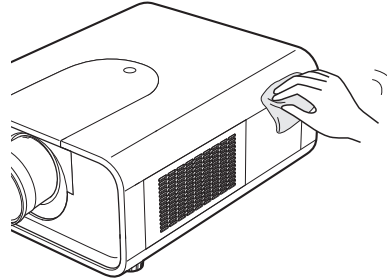

CAUTION

Do not use any flammable solvents or air sprays on the projector and in its vicinity. The explosion or fire hazard may occur even after the AC power cord is unplugged because the temperature inside the projector is extremely high due to the lamps. In addition, there is a risk that the internal parts may be damaged not only by the flammable air spray but also by the cold air.

Warning Indicators

The WARNING indicators show the state of the function which protects the projector. Check the state of the WARNING indicators and the POWER indicator to take proper maintenance.

The projector is shut down and the WARNING TEMP. indicator is blinking red.

When the temperature inside the projector reaches a certain level, the projector will be automatically shut down to protect the inside of the projector. The POWER indicator is blinking while the projector is being cooled down. When the projector has cooled down enough (to its normal operating temperature), it can be turned on again by pressing the ON/STAND-BY button.

✓ **Note:**

The WARNING TEMP. indicator continues to blink even after the temperature inside the projector returns to normal. When the projector is turned on again, the WARNING TEMP. indicator stops blinking.

Top Panel

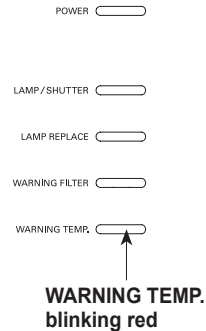

Then check the matters below:

- Did you provide appropriate space for the projector to be ventilated? Check the installing condition to see if the air vents of the projector are not blocked.
- Has the projector been installed near an Air-Conditioning/ Heating Duct or Vent? Move the installation of the projector away from the duct or vent.
- Is the filter clean? Replace the filter with a new one.

The projector is shut down and the LAMP/SHUTTER indicator is lighting and other indicators are blinking.

When the projector detects an abnormal condition, it will be automatically shut down to protect the inside of the projector and the LAMP/SHUTTER indicator lights on and other indicators blink. In this case, unplug the AC power cord and plug it, and then turn on the projector once again to verify operation. If the projector cannot be turned on and these indicators are still lighting and blinking, unplug the AC power cord and contact the service center.

Top Panel

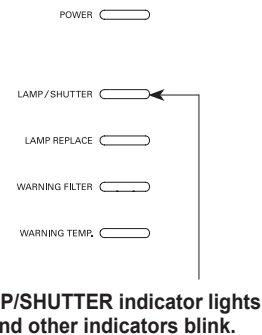

CAUTION

DO NOT LEAVE THE PROJECTOR WITH THE AC POWER CORD CONNECTED UNDER AN ABNORMAL CONDITION. IT MAY RESULT IN FIRE OR ELECTRIC SHOCK.

Troubleshooting

Before calling your dealer or service center for assistance, check the items below once again.

1. Make sure you have properly connected the projector to peripheral equipment as described on pages 20-21.
2. Check the cable connection. Make sure that all computers, video equipment, and power cords are properly connected.
3. Make sure that all power is switched on.
4. If the projector still does not produce an image, restart your computer.
5. If an image still does not appear, disconnect the projector from your computer and check your computer monitor's display. A problem may be noticed with your graphics controller rather than with the projector. (When you reconnect the projector, be sure to turn the computer and monitor off before you turn on the projector. Turn on equipment in the order of the projector and computer.)
6. If a problem still persists, check the following solutions.

Problem:	Solutions
No power.	<ul style="list-style-type: none"> – Plug the power cord of the projector into the AC outlet. – Wait until the POWER indicator stops blinking to turn on the projector again. (See page 23) – Check the WARNING TEMP. indicator. If the WARNING TEMP. indicator is blinking, the projector cannot be turned on. (See page 77) – Unlock the Key lock function for the projector. (See page 65) – See if the filter cartridge is inserted. (See page 72) – Check the projection lamp. (See pages 74-75)
PIN code dialog box appears at start-up.	<ul style="list-style-type: none"> – PIN code lock is being set. Enter a PIN code; the "1234" or numbers you have set. (See pages 23, 65-66)
The initial display is not shown.	<ul style="list-style-type: none"> – Make sure Off or Countdown Off is not chosen at Display function. (See "Setting" section on page 54)
The initial display is not same with the default one.	<ul style="list-style-type: none"> – Make sure User or Off is not chosen at Logo select function. (See "Setting" section on page 54)
When the projector is on and you press the input button, an icon other than the Lamp mode icon appears.	<ul style="list-style-type: none"> – That is the Filter warning icon. (See page 71)
An icon other than Input mode or Lamp mode icon appears.	<ul style="list-style-type: none"> – That is the Lamp replacement icon or the Filter warning icon. (See pages 71, 74)
No image.	<ul style="list-style-type: none"> – Check the connection between your computer or video equipment and the projector. – See if the input signal is correctly output from your computer. Some laptop computers may need to be changed the setting for monitor output when connected to the projector. See your computer's instruction manual for the setting. – It takes about 30 seconds to display an image after turning on the projector. – See if the selected system is corresponding with your computer or video equipment. – Select correct input source once again through menu operation. (See pages 29-34) – Make sure the temperature is not out of Operating Temperature (41°F–104°F [5°C–40°C]). – Make sure that the shutter is opened. (pp.27, 67)
 appears on the screen http://www.pureglare.com.au	<ul style="list-style-type: none"> – End of lamp life is approaching. Replace the lamp with a new one promptly. (See page 74)

 <p>appears on the screen</p>	<ul style="list-style-type: none"> - Filter is out of scroll. Replace the filter cartridge with a new one promptly. (See pages 72-73)
<p>The image is out of focus.</p>	<ul style="list-style-type: none"> - Adjust the focus of the projector. - Check Projection Lens to see if it needs cleaning. ✓ Note: <i>Moving the projector from a cool temperature location to a warm temperature location may result in moisture condensation on Projection Lens. In such cases, leave the projector OFF and wait until condensation evaporates.</i> - Projecting from excessive slant angle to the screen may cause keystone distortion and partial imperfect focus.
<p>The image is not bright enough.</p>	<ul style="list-style-type: none"> - Check if Contrast or Brightness is adjusted properly. (See pages 40, 48) - Check if Image level is selected properly. (See pages 39, 47) - Check the Lamp control function. (See "Setting" section on page 61) - Check the LAMP REPLACE indicator. If it lights, the end of lamp life is approaching. Replace the lamp with a new one promptly. (See page 74)
<p>The color is strange.</p>	<ul style="list-style-type: none"> - Check the Input signal, color system, video system, or computer system mode. - Adjust the Image Level properly. (See pages 40, 47)
<p>The image is Left/ Right reversed.</p>	<ul style="list-style-type: none"> - Check the Ceiling / Rear function. (See pages 45, 52)
<p>The image is Top/ Bottom reversed.</p>	<ul style="list-style-type: none"> - Check the Ceiling function. (See pages 45, 52)
<p>The image is distorted or runs off.</p>	<ul style="list-style-type: none"> - Check PC adjust Menu or Screen Menu and adjust them.
<p>Auto PC adjustment function does not work.</p>	<ul style="list-style-type: none"> - Check the Input signal. Auto PC Adjustment function cannot work when 480p, 575p, 720p, 480i, 575i, 1035i, 1080i or 1080p is selected or when the digital signal is input into HDMI or DVI-D terminal. See page 36.
<p>Some displays are not seen during the operation.</p>	<ul style="list-style-type: none"> - Check the Display function. (see page 54)
<p>The setting does not remain after turning off power.</p>	<ul style="list-style-type: none"> - Make sure you selected Store after adjusting settings. Some settings cannot be stored if not registered with Store function.
<p>Power management function does not work.</p>	<ul style="list-style-type: none"> - Power management function cannot work while Freeze function is running or the shutter is closed.
<p>Image disappears automatically.</p>	<ul style="list-style-type: none"> - Check the power management function in the Setting. The power management is set to On at the factory.
<p>Capture function does not work.</p>	<ul style="list-style-type: none"> - Check the connection to see if there is signal. - Capture function is not available when the Picture in Picture function is set to User1-5.
<p>Some menus cannot be selected.</p>	<ul style="list-style-type: none"> - Each of the Video Input and Computer Input has a limit on selectable menus.
<p>The shutter does not work.</p>	<ul style="list-style-type: none"> - Check "Protection" or "Release key" of the Shutter function. (See p.67)

<p>The power is turned off automatically.</p>	<ul style="list-style-type: none"> – Power management function runs by initial setting. Check “Setting” section on page 63. – If you continue to use the projector without replacing the air filter cartridge and resetting the filter counter after the filter cartridge replacement icon is displayed, the power will switch off automatically approximately 10 hours after projection starts in order to protect the optical parts. After this, the power will switch off automatically 3 minutes after it is turned back on and projection starts. (See pages 71, 87) – Do not cover the ventilation slots on the projector. (See pages 4, 6) – Projector may be used in high ambient temperature environment. Make sure the temperature is not out of Operating Temperature (41°F–104°F [5°C–40°C]). (See page 77)
<p>You cannot operate with the side control.</p>	<ul style="list-style-type: none"> – If the side control is locked at "Key lock" under "Security" of Setting menu, the side control is not available. Please check “Setting” section on page 65.
<p>The Remote Control does not work.</p>	<ul style="list-style-type: none"> – Check the batteries. – Check if the RC sensor is set properly. (See page 62) – Make sure no obstruction is between the projector and remote control. – Make sure you are not too far from the projector when using the remote control. Maximum operating range is 16.4’ (5m). (See page 15) – Make sure that the remote control code conforms to the projector’s code. (See “SETTING” section on page 62.) – Unlock the Key lock function for the remote control. (See page 65) – Wireless remote control does not work when the remote control cable is connected to the projector. (See page 15) – Check if the ON/OFF switch on the remote control is set to “ON.” – Make sure that the simple mode in the remote control function is set to Off (See page 62).
<p>Wireless mouse function does not work.</p>	<ul style="list-style-type: none"> – Check the cable connection between the projector and your computer. (See pages 20, 31) – Check the mouse setting on your computer. – Turn on the projector before you turn on the computer.
<p>Indicators blink or light.</p>	<ul style="list-style-type: none"> – Check the status of the projector with referring to “Indicators and projector condition” on pages 85-87.
<p> appears on the screen</p>	<ul style="list-style-type: none"> – Your operation is invalid. Operate correctly.
<p>Unable to unlock the Logo PIN code lock, Security key lock or Security PIN code lock.</p>	<ul style="list-style-type: none"> – Contact the dealer where you've purchased the projector or the service center.
<p>Forget the Logo PIN code or Security PIN code.</p>	<ul style="list-style-type: none"> – Contact the dealer where you've purchased the projector or the service center.

WARNING:

High voltages are used to operate this projector. Do not attempt to open the cabinet.

If problems still persist after following all operating instructions, contact the dealer where you purchased the projector or the service center. Specify the model number and explain about the problem. We will advise you how to obtain service.

<http://www.pureglare.com.au>

Menu Tree

Computer Input/HDMI Input/Video Input

Input

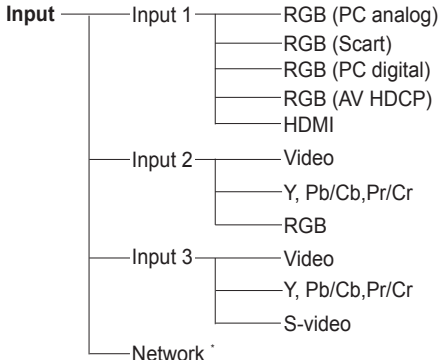

* Network will be displayed only when an optional Network unit is attached.

Information

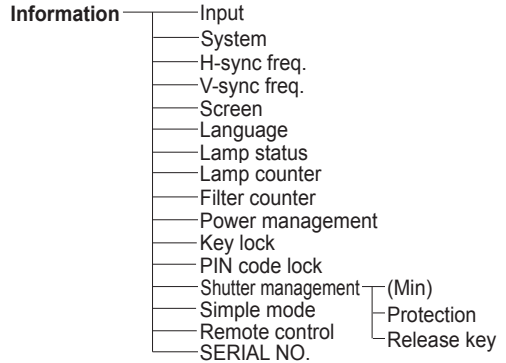

Computer Input

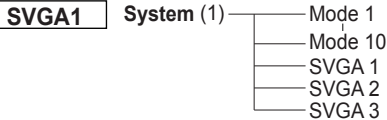

* System displayed in the System Menu varies depending on the input signal.

Image adjust

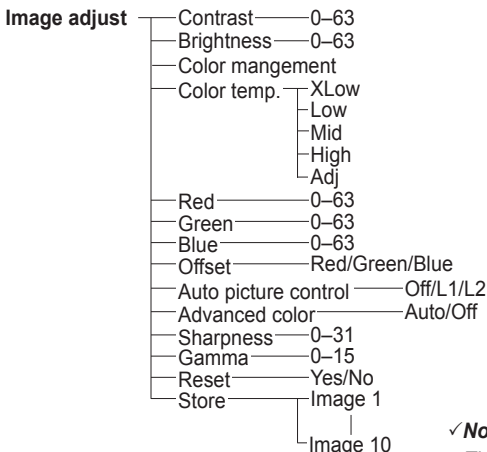
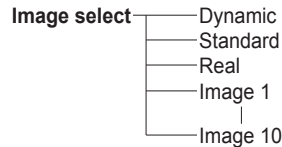
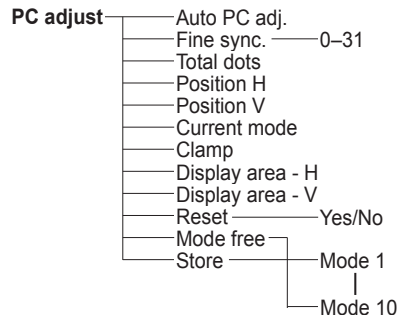

Image select



PC adjust



✓ **Note:**

The Menu display varies depending on the input signal.

<http://www.pureglare.com.au>

Screen

- Screen
 - Normal
 - Full
 - Wide(16:9)
 - Zoom
 - True
 - Custom
 - Custom adj.
 - Scale — H / V
 - H & V — On/Off
 - Position — H / V
 - Common
 - Reset
 - Digital zoom +
 - Digital zoom -
 - Keystone
 - Standard
 - Corner correction
 - Corner pattern
 - Store
 - Ceiling — On/Off
 - Rear — On/Off
 - Screen aspect — Default(16:9)/16:10/4:3
 - Reset

Video Input

- System (2)
 - Auto
 - PAL
 - SECAM
 - NTSC
 - NTSC 4.43
 - PAL-M
 - PAL-N

- System (3)
 - Auto
 - 1080p
 - 1080i
 - 1035i
 - 720p
 - 575p
 - 480p
 - 575i
 - 480i

✓ **Note:**

The Menu display varies depending on the input signal.

HDMI Input/Video Input

Image adjust

- Image adjust
 - Contrast — 0-63
 - Brightness — 0-63
 - Color — 0-63
 - Tint — 0-63
 - Color mangement
 - Color temp.
 - XLow
 - Low
 - Mid
 - High
 - Adj
 - Red — 0-63
 - Green — 0-63
 - Blue — 0-63
 - Offset — Red/Green/Blue
 - Sharpness — 0-31
 - Auto picture control — Off/L1/L2
 - Advanced color — Auto/Off
 - Gamma — 0-15
 - Noise reduction — Off/On
 - Progressive — Off/On/Film
 - Reset — Yes/No
 - Store
 - Image 1
 - Image 10

Image select

- Image select
 - Dynamic
 - Standard
 - Natural
 - Cinema
 - Image 1
 - Image 10

Screen

- Screen
 - Normal
 - Full
 - Wide(16:9)
 - Zoom
 - Natural wide
 - Custom
 - Custom adj.
 - Scale — H / V
 - H & V — On/Off
 - Position — H / V
 - Common
 - Reset
 - Keystone
 - Standard
 - Corner correction
 - Corner pattern
 - Store
 - Ceiling — On/Off
 - Rear — On/Off
 - Screen aspect — Default(16:9)/16:10/4:3
 - Reset

Computer Input/HDMI Input/Video Input

Setting

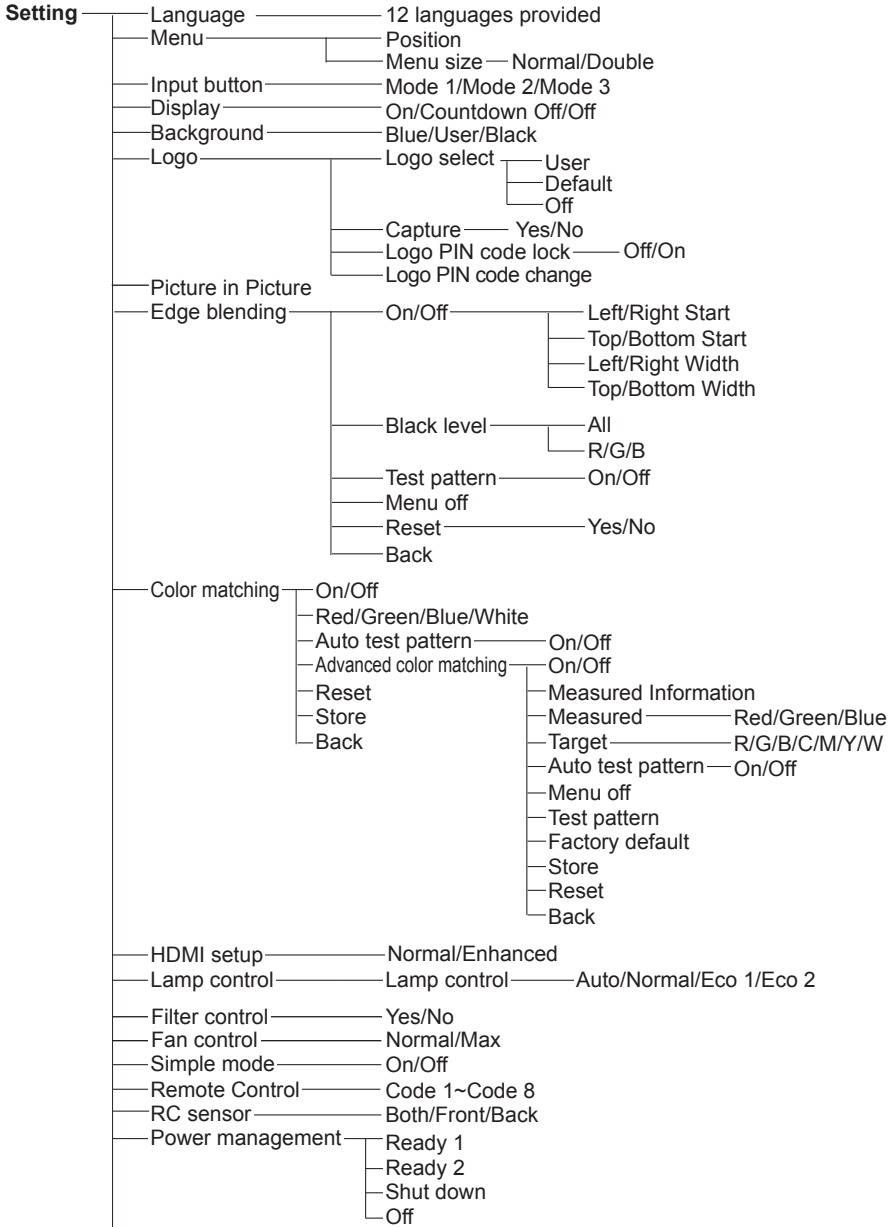

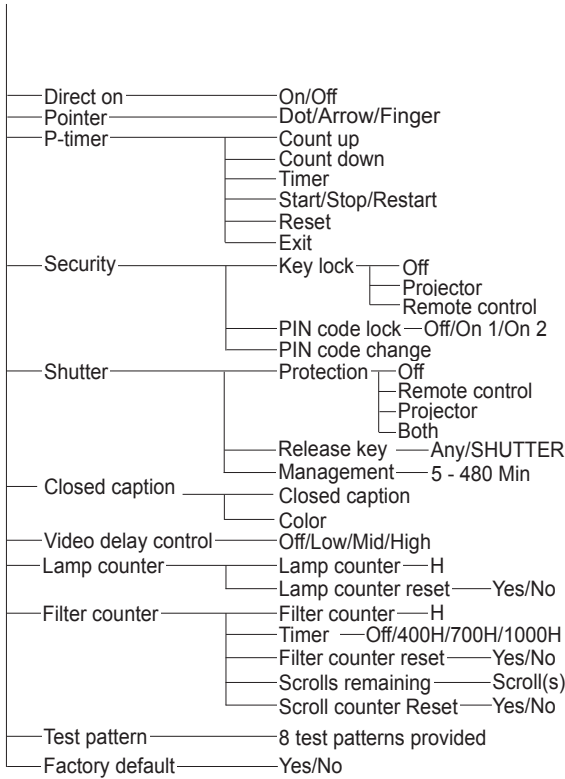

Indicators and Projector Condition

Check the indicators for the projector condition.

The projector is operating normally.

Indicators					Projector Condition
POWER green	LAMP/ SHUTTER red/blue	LAMP REPLACE orange	WARNING FILTER orange	WARNING TEMP. red	
●	●	●	●	●	The projector is off. (The AC power cord is unplugged.)
○	⊕	*	*	*	The projector is in stand-by mode. Press the ON/STAND-BY button to turn on the projector.
○	⊕	*	*	*	The projector is operating normally. (The shutter is open)
○	⊗	*	*	*	The projector is operating normally. (The shutter is closed)
●	⊕	*	*	*	The projector is preparing for stand-by or the projection lamp is being cooled down. The projector cannot be turned on until cooling is completed and the POWER indicator lights green.
●	⊕	*	*	*	The projection lamp is being cooled down in the Power management mode.
○	⊕	*	*	*	The projector is in the Power management mode.
●	⊗	*	*	●	The projection lamp is being cooled down in the Shutter management mode.
○	⊗	*	*	●	The projector is in the Shutter management mode. Press the ON/STAND-BY button to turn on the projector.
○	*	*	⊕	*	The filter is scrolled using the FILTER button on the remote control or the Filter control function in the setting menu. When the filter is being scrolled, the Filter replacement icon and Please wait... message (Fig. 1) appear on the screen for about 30 seconds.



Fig.1 Filter replacement icon and **Please wait....**

- ... on
- ⊕ ... on (red)
- ⊗ ... on (blue)
- ... dim
- ⊕ ... dim (red)
- ... blinking at the normal rate (approx. 1 second ON, 1 second OFF)
- ⊗ ... blinking at the normal rate (blue and dim red) (approx. 1 second ON, 1 second OFF)
- ... off
- ⊕ ... blinking fast (approx. 0.5 seconds ON, 0.5 seconds OFF)
- ⊗ ... blinking fast (blue and dim red) (approx. 0.5 seconds ON, 0.5 seconds OFF)
- ⊕ ... blinking slow (approx. 2 seconds ON, 2 seconds OFF)

* ... Differ according to conditions.

<http://www.pureglare.com.au>

The projector is detecting abnormal condition.

Indicators					Projector Condition
POWER green	LAMP/ SHUTTER red/blue	LAMP REPLACE orange	WARNING FILTER orange	WARNING TEMP. red	
○	⊕	*	*	☉	The temperature inside the projector is elevated close to the abnormally high level.
●	⊕	*	*	☉	The temperature inside the projector is abnormally high. The projector cannot be turned on. When the projector is cooled down enough and the temperature returns to normal, the POWER indicator lights green and the projector can be turned on. (The WARNING TEMP. indicator keeps blinking.) Check and replace the filter.
○	⊕	*	*	☉	The projector has been cooled down enough and the temperature returns to normal. When turning on the projector, the WARNING TEMP. indicator stops blinking. Check and replace the filter.
●	⊕	☉	*	*	The lamp cannot light up. (The projector is preparing for stand-by or the projection lamp is being cooled down. The projector cannot be turned on until cooling is completed.)
○	⊕	☉	*	*	The lamp cannot light up. (The lamp has been cooled down enough and the projector is in stand-by mode and ready to be turned on with the ON/STAND-BY button.)
○	*	○	*	*	The lamp has been used overtime. Replace the lamp immediately.











WARNING FILTER

When the filter detects clogging, reaches a time set in the timer setting or runs out of the filter scroll, the WARNING FILTER indicator lights orange. When this indicator lights orange, replace the filter or the filter cartridge with a new one promptly. Reset the Filter counter and Scroll counter after replacing the filter cartridge (p.73).

LAMP REPLACE

When the projection lamp reaches its end of life, the LAMP REPLACE indicator lights orange. When this indicator lights orange, replace the projection lamp with a new one promptly (p.74).

The projector is detecting abnormal condition.

Indicators					Projector Condition
POWER green	LAMP/ SHUTTER red/blue	LAMP REPLACE orange	WARNING FILTER orange	WARNING TEMP. red	
○	*	*	○	*	<p>If the Filter counter reaches a time set in the timer setting, a Filter replacement icon (Fig.2) will appear on the screen and the WARNING FILTER indicator on the top panel will light up. Replace the filter as soon as possible. If the filter is out of scroll and the projector reaches a time set in the timer setting, Fig. 3 will appear on the screen and the WARNING FILTER indicator will light up. Replace the filter cartridge as soon as possible. If the filter is clogged and no scroll is left in the filter cartridge, a Filter cartridge replacement icon (Fig.4) will appear on the screen and the WARNING FILTER indicator will light up. Replace the filter cartridge as soon as possible.</p> <p>✓ Note: Fig.2, Fig.3 and Fig.4 icon will not appear when the Display function is set to Off (p.54) or during "Freeze" (p.29).</p>
 <p>Fig.2 Filter replacement icon</p>					
 <p>Fig.3</p>  <p>Fig.4 Filter cartridge replacement icon</p>					
					<p>The filter cartridge is not installed in the projector. Check the filter compartment to see if the filter cartridge is installed in the projector. When the filter cartridge is installed and the indicators continue to light and blink, read the column below.</p> <p>The projector detects an abnormal condition and cannot be turned on. Unplug the AC power cord and plug it again to turn on the projector. If the projector is turned off again, unplug the AC power cord and contact the dealer or the service center. Do not leave the projector on. It may cause an electric shock or a fire hazard.</p>
*		*	*	*	The shutter is out of control.
●		*	*	●	The shutter is out of control. (The projector is in the cooling mode.)
○		*	*	●	The shutter is out of control. (The projector is in the stand-by mode.) In that case, contact the service center immediately.

Compatible Computer Specifications

Basically this projector can accept the signal from all computers with the V- and H-Frequency mentioned below and less than 162 MHz of Dot Clock. When the input signal is Analog, refer to the chart below.

ON-SCREEN DISPLAY	RESOLUTION	H-Freq. (kHz)	V-Freq.(Hz)
VGA 1	640x480	31.470	59.880
VGA 2	720x400	31.470	70.090
VGA 3	640x400	31.470	70.090
VGA 4	640x480	37.860	74.380
VGA 5	640x480	37.860	72.810
VGA 6	640x480	37.500	75.000
VGA 7	640x480	43.269	85.000
MAC LC13	640x480	34.970	66.600
MAC 13	640x480	35.000	66.670
480p	640x480	31.470	59.880
575p	768x575	31.250	50.000
575i	768x576 (Interface)	15.625	50.000
480i	640x480 (Interface)	15.734	60.000
SVGA 1	800x600	35.156	56.250
SVGA 2	800x600	37.880	60.320
SVGA 3	800x600	46.875	75.000
SVGA 4	800x600	53.674	85.060
SVGA 5	800x600	48.080	72.190
SVGA 6	800x600	37.900	61.030
SVGA 7	800x600	34.500	55.380
SVGA 8	800x600	38.000	60.510
SVGA 9	800x600	38.600	60.310
SVGA 10	800x600	32.700	51.090
SVGA 11	800x600	38.000	60.510
MAC 16	832x624	49.720	74.550
XGA 1	1024x768	48.360	60.000
XGA 2	1024x768	68.677	84.997
XGA 3	1024x768	60.023	75.030
XGA 4	1024x768	56.476	70.070
XGA 5	1024x768	60.310	74.920
XGA 6	1024x768	48.500	60.020
XGA 7	1024x768	44.000	54.580
XGA 8	1024x768	63.480	79.350
XGA 9	1024x768 (Interface)	36.000	87.170
XGA 10	1024x768	62.040	77.070
XGA 11	1024x768	61.000	75.700
XGA 12	1024x768 (Interface)	35.522	86.960
XGA 13	1024x768	46.900	58.200
XGA 14	1024x768	47.000	58.300
XGA 15	1024x768	58.030	72.000
MAC 19	1024x768	60.240	75.080
SXGA 1	1152x864	64.200	70.400
SXGA 2	1280x1024	62.500	58.600
SXGA 3	1280x1024	63.900	60.000
SXGA 4	1280x1024	63.340	59.980
SXGA 5	1280x1024	63.740	60.010
SXGA 6	1280x1024	71.690	67.190
SXGA 7	1280x1024	81.130	76.107
SXGA 8	1280x1024	63.980	60.020
SXGA 9	1280x1024	79.976	75.025
SXGA 10	1280x960	60.000	60.000
SXGA 11	1152x900	61.200	65.200
SXGA 12	1152x900	71.400	75.600

ON-SCREEN DISPLAY	RESOLUTION	H-Freq. (kHz)	V-Freq.(Hz)
SXGA 13	1280x1024 (Interface)	50.000	86.000
SXGA 14	1280x1024 (Interface)	50.000	94.000
SXGA 15	1280x1024	63.370	60.010
SXGA 16	1280x1024	76.970	72.000
SXGA 17	1152x900	61.850	66.000
SXGA 18	1280x1024 (Interface)	46.430	86.700
SXGA 19	1280x1024	63.790	60.180
SXGA 20	1280x1024	91.146	85.024
SXGA+ 1	1400x1050	63.970	60.190
SXGA+ 2	1400x1050	65.350	60.120
SXGA+ 3	1400x1050	65.120	59.900
SXGA+ 4	1400x1050	64.030	60.010
SXGA+ 5	1400x1050	62.500	58.600
SXGA+ 6	1400x1050	64.744	59.948
SXGA+ 7	1400x1050	65.317	59.978
MAC 21	1152x870	68.680	75.060
MAC	1280x960	75.000	75.080
MAC	1280x1024	80.000	75.080
WXGA 1	1366x768	48.360	60.000
WXGA 2	1360x768	47.700	60.000
WXGA 3	1376x768	48.360	60.000
WXGA 4	1360x768	56.160	72.000
WXGA 6	1280x768	47.776	59.870
WXGA 7	1280x768	60.289	74.893
WXGA 8	1280x768	68.633	84.837
WXGA 9	1280x800	48.360	60.050
WXGA 10	1280x800	41.200	50.000
WXGA 11	1280x800	49.702	59.810
WXGA 12	1280x800	63.980	60.020
WXGA 17	1280x800	58.289	69.975
WXGA 18	1280x800	60.044	71.995
WXGA 19	1280x800	62.790	74.928
WXGA 20	1280x800	71.553	84.879
WXGA 21	1280x800	55.993	69.991
WXGA 22	1280x800	57.675	72.004
WUXGA 1	1920x1200	74.556	59.885
WUXGA 2	1920x1200	74.038	59.950
WSXGA +1	1680x1050	65.290	59.954
WXGA +1	1440x900	55.935	59.887
WXGA +2	1440x900	74.918	60.000
UXGA 1	1600x1200	75.000	60.000
UXGA 2	1600x1200	81.250	65.000
UXGA 3	1600x1200	87.500	70.000
UXGA 4	1600x1200	93.750	75.000
UXGA 5	1600x1200	106.250	85.000
720p	1280x720	45.000	60.000
720p	1280x720	37.500	50.000
1035i	1920x1035 (Interface)	33.750	60.000
1080i	1920x1080 (Interface)	33.750	60.000
	1920x1080 (Interface)	28.125	50.000

✓ **Note:**

* **True cannot be selected when * is selected. (p.43)**

When the input signal is digital from HDMI/DVI-D terminal, refer to the chart below.

ON-SCREEN DISPLAY	RESOLUTION	H-Freq. (kHz)	V-Freq.(Hz)	ON-SCREEN DISPLAY	RESOLUTION	H-Freq. (kHz)	V-Freq.(Hz)
1080p	1920x1080	33.750	30.000	D-WXGA 20	1280x800	71.553	84.879
	1920x1080	28.125	25.000	D-WXGA 21	1280x800	55.993	69.991
	1920x1080	27.000	24.000	D-WXGA 22	1280x800	57.675	72.004
	1920x1080	67.500	60.000	D-SXGA 1	1280x1024	63.980	60.020
	1920x1080	56.250	50.000	D-SXGA 2	1280x1024	60.276	58.069
1080psf/30	1920x1080	33.750	60.000	D-SXGA+ 1	1400x1050	63.970	60.190
1080psf/25	1920x1080	28.125	50.000	D-SXGA+ 2	1400x1050	65.350	60.120
1080psf/24	1920x1080	27.000	48.000	D-SXGA+ 3	1400x1050	65.120	59.900
D-VGA	640x480	31.470	59.940	D-SXGA+ 4	1400x1050	64.030	60.010
D-480i	720x480	15.734	60.000	D-SXGA+ 5	1400x1050	62.500	58.600
D-575i	720x576	15.625	50.000	D-SXGA+ 6	1400x1050	64.744	59.948
D-480p	720x480	31.470	60.000	D-SXGA+ 7	1400x1050	65.317	59.978
D-575p	720x575	31.250	50.000	D-UXGA	1600x1200	75.000	60.000
D-SVGA	800x600	37.879	60.320	D-WUXGA 2	1920 x 1200	74.038	59.950
D-XGA	1024x768	43.363	60.000	D-WSXGA+ 1	1680 x 1050	65.290	59.954
D-WXGA 1	1366x768	48.360	60.000	D-WXGA+ 1	1440x900	55.935	59.887
D-WXGA 2	1360x768	47.700	60.000	D-720p	1280x720	45.000	60.000
D-WXGA 3	1376x768	48.360	60.000	D-720p	1280x720	37.500	50.000
D-WXGA 4	1360x768	56.160	72.000	D-1035i	1920x1035 (Interlace)	33.750	60.000
D-WXGA 5	1366x768	46.500	50.000	D-1080i	1920x1080 (Interlace)	33.750	60.000
D-WXGA 6	1280x768	47.776	59.870		1920x1080 (Interlace)	28.125	50.000
D-WXGA 7	1280x768	60.289	74.893		D-1080psf/30	1920x1080	33.750
D-WXGA 8	1280x768	68.633	84.837	D-1080psf/25	1920x1080	28.125	50.000
D-WXGA 9	1280x800	49.600	60.050	D-1080psf/24	1920x1080	27.000	48.000
D-WXGA 10	1280x800	41.200	50.000	D-1080p	1920x1080	33.750	30.000
D-WXGA 11	1280x800	49.702	59.810		1920x1080	28.125	25.000
D-WXGA 12	1280x800	63.980	60.020		1920x1080	27.000	24.000
D-WXGA 17	1280x800	58.289	69.975		1920x1080	67.500	60.000
D-WXGA 18	1280x800	60.044	71.995		1920x1080	56.250	50.000
D-WXGA 19	1280x800	62.790	74.928				

✓ **Note:**

- Depending on the condition of signals and the type and length of cables, these signals may not be properly viewed.
 - Specifications are subject to change without notice.
 - You might be able to project images even when signals other than above are inputted, however the functions of the projector could be limited.
 - Depending on your PC settings, the digital signals of your PC may not be projected correctly. In such a case, confirm your PC settings.
 - When you project a DVI signal, connect the cables, turn the projector on, then select the input. Finally, turn on your PC.
- Be sure to follow this procedure, otherwise an image may not be projected on the screen. If an image is not projected correctly, restart your PC.
- Do not disconnect the cable while the projector is running. If the cable has been disconnected and then reconnected, an image may not be correctly projected.

CE The CE Mark is a Directive conformity mark of the European Community (EC).

Licensed under USP 5,717,422 USP 6,816,141



This symbol on the nameplate means the product is Listed by Underwriters Laboratories Inc. It is designed and manufactured to meet rigid U.L. safety standards against risk of fire, casualty and electrical hazards.

Technical Specifications

Mechanical Information

Projector Type	Multi-media Projector
Dimensions (W x H x D)	14.56" x 7.36" x 17.32" (370.0 mm x 187.0 mm x 439.9 mm)
Net Weight	25.6 lbs (11.6 kg)
Feet Adjustment	0' to 6.5'

Panel Resolution

LCD Panel System	1.2" TFT Active Matrix type, 3 panels
Panel Resolution	1,920 x 1,080 dots
Number of Pixels	6,220,800 (1,920 x 1,080 x 3 panels)

Signal Compatibility

Color System	PAL, SECAM, NTSC, NTSC4.43, PAL-M, and PAL-N
SD/HD TV Signal	480i, 480p, 575i, 575p, 720p, 1035i, 1080i and 1080p
Input Scanning Frequency	H-sync. 15 kHz–120 kHz, V-sync. 48 Hz–100 Hz

Optical Information

Projection Lamp	380 W lamp
-----------------	------------

Interface

Input 1	DVI [RGB(PC digital), RGB(AV HDCP)] / HDMI (1.3 with Deepcolor) / Mini D-sub15pin [RGB, RGB (Scart)]
Input 2	BNC Type x 5 (G or Video/Y, B or Pb-Cb, R or Pr-Cr, H/HV and V)
Input 3	RCA Type x 3 (Video/Y, Pb/Cb, Pr/Cr), Mini DIN 4 pin x 1 (S-video)
Monitor Out	Analog RGB (Mini D-sub 15 pin) Terminal x 1
R/C Jack	Mini jack (Wired Remote) x 1
Control Port	D-sub 9 pin x 1
USB Connector	USB Series B x 1
Option	Network unit Terminal x 1
LAN Connection Terminal	RJ-45

Power

Voltage and Power Consumption	AC 100-120 V (5.9A Max.), 50/60 Hz (The U.S.A and Canada) AC 100-240 V (5.9-2.4A Max.), 50/60Hz (For other countries)
-------------------------------	--

Operating Environment

Operating Temperature	41°F–104°F (5°C–40°C)
Storage Temperature	14°F–140°F (-10°C–60°C)

Remote Control

Battery	AAA or LR03 Type x 2
Operating Range	16.4' (5 m/±30')
Dimensions	1.9" (W) x 1.1" (H) x 5.7" (D) (48 mm x 27 mm x 145 mm)
Net Weight	3.6 oz (102 g) (including batteries)

Accessories

User manual (CD-ROM)	Lens Attachment (For option lens)
Network Application (CD-ROM)	Light-block sheet (For option lens)
Quick Reference Guide	Spacer (For option lens)
AC Power Cord	VGA Cable
Remote Control and Batteries	
PIN Code Label	

- The specifications are subject to change without notice.
- LCD panels are manufactured to the highest possible standards. Even though 99.99% of the pixels are effective, a tiny fraction of the pixels (0.01% or less) may be ineffective by the characteristics of the LCD panels.

Optional Parts

The parts listed below are optionally available. When ordering those parts, specify the item name and Model No. to the sales dealer.

	Model No.
Standard Zoom Lens	: 103-142108-01
Long Zoom Lens	: 103-143109-01
Ultra Long Zoom Lens	: 38-809068-51, 103-123107-01
Short Zoom Lens	: 103-141107-01
Short Fixed Lens	: 103-140106-01
Network option	: 103-115108-02

Lens Replacement

The lens of this projector can be replaced with other optional lens. This feature enables you to use the projector for wide variety of uses.
 For installation and replacement of the lens, always contact the sales dealer. The projector lens must be installed or replaced by well-trained sales or service engineers. Do not attempt to install and replace the lens by yourself as it may cause injury.



Do not hold the lens when carrying or lifting the projector. It may cause serious damage to the projector.

To the sales and service

For the lens replacement and lens installation, refer to the installation manual of the optional lens. Before replacing and installing the lens, make sure that you are using the lens with the correct Type No.

Configurations of Terminals

ANALOG/ ANALOG OUT (Mini D-sub 15 pin)

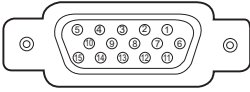

Input

1	Red Input	9	+5V Power
2	Green Input	10	Ground (Vert.sync.)
3	Blue Input	11	Ground
4	No Connect	12	DDC Data
5	Ground (Horiz.sync.)	13	Horiz. sync. Input (Composite H/V sync.)
6	Ground (Red)	14	Vert. sync. Input
7	Ground (Green)	15	DDC Clock
8	Ground (Blue)		

Output

1	Red Output	9	No Connect
2	Green Output	10	Ground (Vert.sync.)
3	Blue Output	11	No Connect
4	No Connect	12	No Connect
5	Ground (Horiz.sync.)	13	Horiz. sync. Output
6	Ground (Red)	14	Vert. sync. Output
7	Ground (Green)	15	No Connect
8	Ground (Blue)		

DIGITAL DVI-D (DVI 24 PIN)

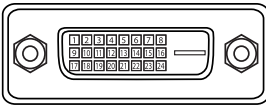

1	T.M.D.S. Data2-	9	T.M.D.S. Data1-	17	T.M.D.S. Data0-
2	T.M.D.S. Data2+	10	T.M.D.S. Data1+	18	T.M.D.S. Data0+
3	T.M.D.S. Data2 Shield	11	T.M.D.S. Data1 Shield	19	T.M.D.S. Data0 Shield
4	No Connect	12	No Connect	20	No Connect
5	No Connect	13	No Connect	21	No Connect
6	DDC Clock	14	+5V Power	22	T.M.D.S. Clock Shield
7	DDC Data	15	Ground (for +5V)	23	T.M.D.S. Clock+
8	No Connect	16	Hot Plug Detect	24	T.M.D.S. Clock-

HDMI (19 Pin Type A)

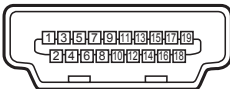

1	TMDS Data 2+ Input	11	Ground (TMDS Clock)
2	Ground (TMDS Data 2)	12	TMDS Clock- Input
3	TMDS Data 2- Input	13	-----
4	TMDS Data 1+ Input	14	-----
5	Ground (TMDS Data 1)	15	SCL
6	TMDS Data 1- Input	16	SDA
7	TMDS Data 0+ Input	17	Ground (DDC/CEC)
8	Ground (TMDS Data 0)	18	+5V Power
9	TMDS Data 0- Input	19	Plug insert detection
10	TMDS Clock+ Input		

USB CONNECTOR (Series B)

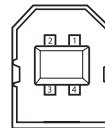

1	Vcc
2	- Data
3	+ Data
4	Ground

CONTROL PORT CONNECTOR (D-sub 9 pin)

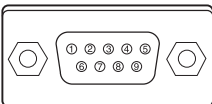

Serial	
1	-----
2	RXD
3	TXD
4	-----
5	SG
6	-----
7	-----
8	-----
9	-----

LAN TERMINAL

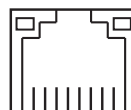

87654321

1	TX +	5	-----
2	TX -	6	RX -
3	RX +	7	-----
4	-----	8	-----

PIN Code Number Memo

Write down the PIN code number in the column below and keep it with this manual securely. If you forgot or lost the number and unable to operate the projector, contact the service center.

PIN Code Lock No.	<input type="text"/> <input type="text"/> <input type="text"/> <input type="text"/>
	Factory default set No: 1 2 3 4*
Logo PIN Code Lock No.	<input type="text"/> <input type="text"/> <input type="text"/> <input type="text"/>
	Factory default set No: 4 3 2 1*
	<small>*Should the four-digit number be changed, the factory set number will be invalid.</small>

While the projector is locked with the PIN code...

Put the label below (supplied) on in a prominent place of the projector's body while it is locked with a PIN code.

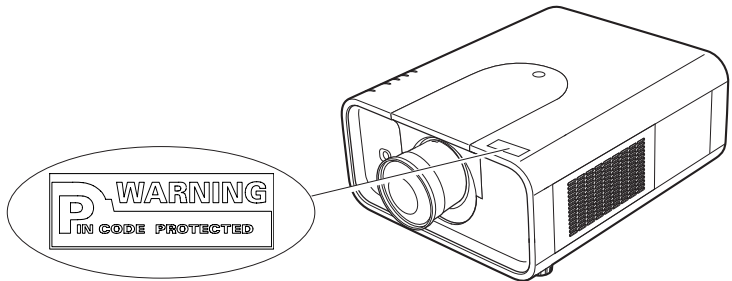

Dimensions

Unit: inch (mm)

- ↘ Screw Holes for Ceiling Mount
- Screw: M6
- Depth: 0.393 (10.0)

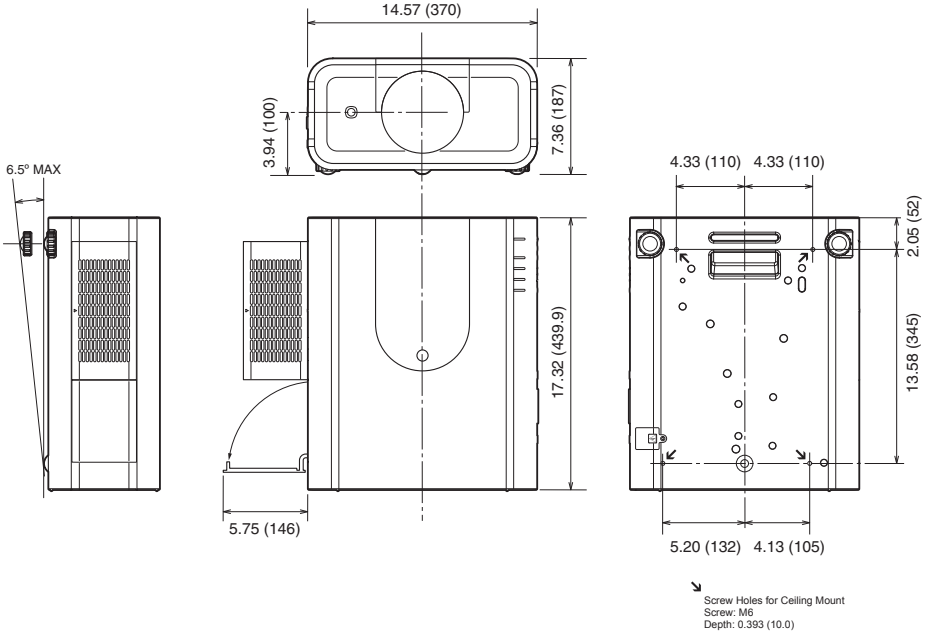

List of Picture in Picture

Sub Window		INPUT1				INPUT2			INPUT3		
Main Window		PC	SCART	DVI	HDMI	PC	YCbCr	VIDEO	YCbCr	VIDEO	S-VIDEO
INPUT1	PC	x	x	○	○	○	○	○	○	○	○
	SCART	x	x	○	○	○	○	x	○	x	x
	DVI	○	○	x	x	○	○	○	○	○	○
	HDMI	○	○	x	x	○	○	○	○	○	○
INPUT2	PC	○	○	○	○	x	x	x	○	○	○
	YCbCr	○	○	○	○	x	x	x	○	○	○
	VIDEO	○	x	○	○	x	x	x	x	x	x
INPUT3	YCbCr	○	○	○	○	○	○	x	x	x	○
	VIDEO	○	x	○	○	○	○	x	x	x	x
	S-VIDEO	○	x	○	○	○	○	x	○	x	x

○ : Picture in Picture combinations are enabled.

x : Picture in Picture combinations are disabled.

✓ **Note:**

- When the input signal(s) is/are incompatible, **X** mark will be displayed on the Main/Sub picture.
- Depending on the frequency or signal type of PC/AV input, the display resolution may be lowered or images may not be displayed on the Main/Sub picture.
<Display resolution is lowered when;>
 - Inputting PC analog signals: Between 100-162 MHz
- <Images are not displayed and X mark appears when;>
 - Inputting PC analog signals: More than 162 MHz
 - Inputting PC digital signals: More than 100 MHz
 - Inputting AV digital signals: 1080p
- <Picture in Picture is disabled when;>
 - Inputting signal formats: WUXGA 1, WXGA+2, UXGA 2, UXGA 3, UXGA4, D-1080p

Serial Control Interface

This projector provides a function to control and monitor the projector's operations by using the RS-232C serial port.

Operation

- 1 Connect a RS-232C serial cross cable to CONTROL PORT on the projector and serial port on the PC. (See p.19)
- 2 Launch a communication software provided with PC and setup the communication condition as follows:

Baud rate	: 9600 / 19200 bps
Parity check	: none
Stop bit	: 1
Flow control	: none
Data bit	: 8

✓ **Note:**

*The default of the baud rate is set to **19200 bps**. If an error occurs in the communication, change the serial port and the communication speed (baud rate).*

- 3 Type the command for controlling the projector and then enter the "Enter" key.

Example

When you want to change the input to INPUT 2,
Type 'C' '0' '6' 'Enter'.
<http://www.pureglare.com.au>

✓ **Note:**

Enter with ASCII 64-byte capital characters and one-byte characters.

Functional Execution Command

Format

The command is sent from PC to the projector with the format below;

'C' [Command] 'CR'

Command: two characters (refer to the command table below.

-The projector decodes the command and returns the 'ACK' with the format below;

'ACK' 'CR'

-When the projector can not decode the command, it returns with format below.

'?' 'CR'

Command	Function
C00	Turn the projector ON
C01	Turn the projector OFF (immediately OFF)
C02	Turn the projector OFF
C05	Select Input 1
C06	Select Input 2
C07	Select Input 3
C08	Select Network
C0D	Video mute ON
C0E	Video mute OFF
C0F	Screen Normal Size
C10	Screen Full Size
C1C	Menu ON
C1D	Menu OFF
C20	Brightness UP
C21	Brightness DOWN
C23	Select Input 2 Video
C24	Select Input 2 Y, Pb/Cb,Pr/Cr
C25	Select Input 2 RGB
C28	Direct on ON
C29	Direct on OFF
C33	Select Input 3 Video
C34	Select Input 3 S-video
C35	Select Input 3 Y, Pb/Cb,Pr/Cr

Command	Function
C3A	Pointer RIGHT
C3B	Pointer LEFT
C3C	Pointer UP
C3D	Pointer DOWN
C3F	Enter
C46	Zoom DOWN
C47	Zoom UP
C4A	Focus DOWN
C4B	Focus UP
C4F	Select Input 1 HDMI
C50	Select Input 1 Analog RGB
C51	Select Input 1 SCART
C52	Select Input 1 DVI (PC Digital)
C53	Select Input 1 DVI (AV HDCP)
C5D	Lens shift UP
C5E	Lens shift DOWN
C5F	Lens shift LEFT
C60	Lens shift RIGHT
C89	Auto PC adj.
C8E	Keystone UP
C8F	Keystone DOWN
C90	Keystone RIGHT
C91	Keystone LEFT

Status Read Command

Format

The command is sent from PC to the projector with the format below;

'CR' [Command] 'CR'

Command: one character (refer to the command table below).

The projector decodes the command and returns the 'Character string' with the format below;

Command	Function	Projector Return	Projector status
CR0	Status Read	00	Power On
		80	Stand-by mode
		40	Countdown
		20	Cooling down
		10	Power Malfunction
		28	Cooling down at the temperature anomaly
		24	Cooling down at Power Management mode
		04	Power Management mode after Cooling down
		21	Cooling down after the projector is turned off when the lamps are out.
		81	Stand-by mode after Cooling down when the lamps are out.
		88	Stand-by mode after Cooling down at the temperature anomaly.
		2C	Cooling down when the projector is turned off by the shutter management function.
8C	Stand-by mode after cooling down by the shutter management function.		
CR6	Temperature Read	%1 %2 %3	%1 = Temperature at Sensor 1 (°C) %2 = Temperature at Sensor 2 (°C) %3 = Temperature at Sensor 3 (°C) (ex.) %1 = 12.3°C, %2 = 23.4°C, %3 = 34.5°C --> The projector displays "12.3 23.4 34.5" (For each sensor, two digit and the tenth place numbers are displayed with a space between each temperature.)
		?	Communication failure

The tables on page 96 and 97 show the typical command lists for controlling the projector. Please consult your local dealer for further information of other commands.

CHRISTIE®

Americas

USA

Christie Digital Systems USA, Inc.
10550 Camden Drive
Cypress CA 90630
PH: 714-236-8610
FX: 714-503-3375
Customer Service: 1-866-880-4462
sales-us@christiedigital.com

Canada

Christie Digital Systems Canada, Inc.
809 Wellington St. N.
Kitchener, Ontario N2G 4Y7
PH: 519-744-8005
FX: 519-749-3321
Customer Service: 1-800-265-2171
sales-canada@christiedigital.com

Chile

**Representative Office
Christie Digital Systems USA, Inc.**
Av. Pedro Fontova 7619 of 60
Santiago
PH: 56-2-721 11 75
Mobile: 5699 436 6555

Europe, Middle East & Africa

United Kingdom

**Branch Office
Christie Digital Systems Canada, Inc.**
ViewPoint
200 Ashville Way
Wokingham
Berkshire, U.K.
RG41 2PL
PH: +44 (0) 118 977 8000
FX: +44 (0) 118 977 8100
sales-europe@christiedigital.com

France

**Representative Office
Christie Digital Systems Canada, Inc.**
Blätmont D-Hall 4
Parc Louis Roche
96/114 Avenue Louis Roche
F-92230 Gennevilliers
France
PH: +33 (0)1 41 21 44 04
FX: +33 (0)1 41 21 00 36
sales-france@christiedigital.com

Germany

**Representative Office
Christie Digital Systems Canada, Inc.**
Willcher Damm 129
D-41066
Mönchengladbach
PH: +49 2161 664540
FX: +49 2161 664546
sales-germany@christiedigital.com

Eastern Europe

**Representative Office
Christie Digital Systems Canada, Inc.**
Regus Bank Centre
Szabadsag ter 7.
H-1054 Budapest
Hungary
PH: +36 (0)1 47 48 100
FX: +36 (0)1 47 48 452
sales-europe@christiedigital.com

Middle East

**Representative Office
Christie Digital Systems Canada, Inc.**
C/O Emirates Group Security
Building
C Block, Room 207, 208, 209
Airport Free Zone
PO Box 293762
Dubai, UAE
PH: +971 (0) 4 299 7575
FX: +971 (0) 4 299 8077

Spain

Christie Authorized Reseller
Antonio Abad
Polígono Industrial Ventorro Del
Cano
Esquina C/ Aldea del Fresno, 3
3ª Puerta. Izqda
28925 Alcorcón, Madrid
PH: + 34 91 633 9990
FX: + 34 91 633 9991

Italy

Christie Authorized Reseller
Angelo Tacca
Via Garibaldi, 88
20024 Garbagnate Milanese (MI)
PH: +39 02 9902 1161
FX: +39 02 9902 2641

Africa

**Representative Office
Christie Digital Systems Canada, Inc.**
4 Patricia Road
Gillitts
KwaZulu Natal
3610
Republic of South Africa
PH: +27 (0) 317 671 347
FX: +27 (0) 317 671 347
MB: +27 (0) 823 045 442

Asia Pacific

Singapore

**Branch Office
Christie Digital Systems USA, Inc.**
627A Aljunied Road
05-02 Biz Tech Centre
Singapore, 389842
PH: +65 6877-8737
FX: +65 6877-8747
sales-singapore@christiedigital.com

China - Beijing

**Representative Office
Christie Digital Systems USA, Inc.**
7B15, Hanwei Plaza
Guanghua Road
Chaoyang District,
Beijing, 100004
PH: +86 10 6561 0240
FX: +86 10 6561 0546
sales-china@christiedigital.com

China - Shanghai

**Representative Office
Christie Digital Systems USA, Inc.**
Room 1109-1116 Shartex Plaza
No. 88 Zun Yi South Road
Shanghai 200336
PH: +86 21 6278 7708
FX: +86 21 6278 5816
sales-china@christiedigital.com

Japan

**Representative Office
Christie Digital Systems USA, Inc.**
A-bldg., 2nd Floor
Ariake Frontier Building
3-1-25, Ariake, Koto-ku
Tokyo, 135-0063
PH: 81-3-3599-7481
FX: 81-3-3599-7482
sales-japan@christiedigital.com

South Korea

**Representative Office
Christie Digital Systems USA, Inc.**
6F, ILSIN Building, 15-15
Yeouido-dong,
Yeongdeungpo-gu, Seoul,
150-872 South Korea
PH: +82 2 702 1601
FX: +82 2 702 1602

India

**Representative Office
Christie Digital Systems USA, Inc.**
Unit No. 03, Navigator Building
International Technology Park
Whitefield Road
Bangalore 560 066
India
PH: (080) 41468941 – 48
FX: (080) 41468949

www.christiedigital.com

Corporate offices

USA – Cypress
ph: 714-236-8610

Canada – Kitchener
ph: 519-744-8005

Worldwide offices

United Kingdom
ph: +44 118 977 8000

France
ph: +33 (0) 1 41 21 00 36

Germany
ph: +49 2161 664540

Eastern Europe
ph: +36 (0) 1 47 48 100

Middle East
ph: +971 (0) 4 299 7575

Spain
ph: + 34 91 633 9990

Singapore
ph: +65 6877-8737

Beijing
ph: +86 10 6561 0240

Shanghai
ph: +86 21 6278 7708

Japan
ph: 81-3-3599-7481

South Korea
ph: +82 2 702 1601

