

Canon

MULTIMEDIA PROJECTOR

WUX5000

WUX4000

WX6000

SX6000

**User's Manual /
Installation
Manual**



AISYS
Aspectual Illumination
System

HDMI™
HIGH DEFINITION MULTIMEDIA INTERFACE

PJLink™

Table of Contents

Safety Instructions

Before Use

Projecting an Image

Useful Functions Available
During a Presentation

Setting Functions from Menus

Installation

Connecting to a Network

Maintenance

Appendix

Index

User's Manual

Installation Manual

Appendix

ENG

How to Use This Manual

Thank you for purchasing a Canon projector.

The WUX5000 / WUX4000 / WX6000 / SX6000 Multimedia Projector (hereinafter referred to as “the projector”) is a high-performance projector that is capable of projecting a high-resolution computer screen and high-quality digital image on a large screen.

User’s Manual (Operation) / Installation Manual (Installation and Maintenance) (This Manual)

This manual combines the user’s manual and the installation manual for the WUX5000 / WUX4000 / WX6000 / SX6000 Multimedia Projectors. The user’s manual provides information on how to use the projector. The installation manual describes how to install the projector and connect to a network, as well as perform maintenance. Read this manual thoroughly to make the most of your projector. Installation of the projector should be performed by a qualified technician. Contact the Canon Customer Support Center for further information.

Symbols of Button Operations

The projector can be operated using the buttons on the remote control or on the side of the projector. The remote control allows you to operate all functions of the projector. In this document, the button’s operations are shown as below.

Operation of buttons on side of projector

Remote control button operation

Adjusting the Image Size
The size of the projected image can be adjusted by remote control or the LENS button on the projector. Change the projector installation position if you do adjust it with the zoom function. (P155)

7 Press either the ZOOM button on the remote control

WUX5000 / WUX4000 www.canon.com WX6000 / SX6000

Indicate the buttons to be pressed

Symbols Used in This Manual

Meanings of the symbols used in this manual are as follows.

⚠ A precaution about operation or restriction is given here.

WUX5000 / WUX4000 These descriptions are for WUX5000 / WUX4000.

WX6000 / SX6000 These descriptions are for WX6000 / SX6000.

WUX4000 These descriptions are for WUX4000.

WX6000 These descriptions are for WX6000.

COPYRIGHT NOTICE

Please note that enlarging or reducing the size of an image for commercial purposes or public presentation may infringe on the legally protected copyright or the copyright holder of the original material.

About Trademarks

- Ethernet is a registered trademark of Xerox Corporation.
- Microsoft, Windows, Windows XP, Windows Vista and Windows 7 are registered trademarks or trademarks of Microsoft Corporation in the United States and / or other countries.
- Mac, Mac OS and Macintosh are trademarks of Apple Inc., registered in the United States and / or other countries.
- HDMI, the HDMI logo and High-Definition Multimedia Interface are trademarks or registered trademarks of HDMI Licensing, LLC.
- PjLink is a registered trademark, or an application has been submitted for trademark, in Japan, the United States and / or other countries or regions.

Quick Reference Guide

This Quick Reference Guide will help you find functions that make full use of the projector and are useful for producing an attractive presentation, etc.

Connecting the Projector

Connecting to the Computer (P47 - P51)
Connecting to AV Equipment (P52 - P55)

Projecting an Image

Starting Projection (P56 - P58)
Selecting an Input Signal (P59 - P60)

Adjusting the Image

Adjusting the Image Size and Focus (P71 - P73)
Adjusting Keystone Distortion (P76)
Adjusting Aspect Ratio (P63 - P70)
Eliminating Flickers from Computer Screen and Adjusting Positional Shift (P96, P97)

Adjusting Colors and Image Quality

Projecting an Image on a Greenboard (P103)
Selecting an Image Mode Suitable for the Projecting Image (P109)
Making Fine Color Adjustments (P114)
Removing Noise (P116)

Producing a Presentation

Temporarily Blacking Out an Image (P82)
Freezing the Picture (P82)
Adjusting the Volume (P83)
Muting the Sound (P83)
Zooming an Image (P84)
WUX5000 / WUX4000
Showing the Elapsed Time (P85)

Changing the Remote Control Channel (P124)

Resetting Projector Setting

Resetting Password (P128)
Initializing the Network Setting (P176)
Resetting to the Default Setting (P140)

Miscellaneous Functions

Using the Power Saving Mode (P120)
Turning on the Projector by Connecting the Power Cord (P121)
Disabling the Beep During Operation (P122)
Disabling Buttons (P123)
Hiding Guide Messages (P126)
Setting a Password (P128)
WUX4000
Reducing the Lamp Brightness (P119)
WX6000 / SX6000
Displaying Test Pattern (P138)
Selecting Audio In Terminal (P139)

Table of Contents

How to Use This Manual	2
Quick Reference Guide	4
Safety Instructions	12
Safety Precautions	13
CAUTION ON HANGING FROM THE CEILING	13
■ READ AND KEEP THIS OWNER'S MANUAL FOR LATER USE	14
AC Power Cord Requirement	16
Federal Communication Commission Notice	17
Canadian Radio Interference Regulations	17
Precautions for Use	18
Precautions for Installation	19
Precautions on the lamp	21
Precautions for the batteries of the remote control	22
Before Use	25
Supplied Accessories	26
■ Installing Remote Control Batteries	27
Preparing the Remote Control	29
■ Remote Control Operating Range	29
■ When a remote control is connected using a cable (WX6000 / SX6000)	30
Part Names	31
Main Unit (The illustration shows WUX5000.)	31
■ Front Side	31
■ Rear Side	32
■ Bottom Side	32
Remote Control	34
■ RS-RC04	34
■ RS-RC05	36
Side Control	38
■ LED Indicator Displays	39
Input Terminal	40

User's Manual (Operation)

43

Projecting an Image	45
Steps for Connecting the Projector and Projecting an Image	46
Connecting the Projector	47
Connecting the Projector to a Computer	47
■ Connecting to RGB Monitor Output Terminal (Analog Connection)	47
■ Connecting to DVI Monitor Output Terminal (Digital Connection)	50
■ Connecting with a HDMI Cable (Input signal type: [HDMI] – P59)	51
■ Outputting Audio to Speakers	51

Table of Contents

Connecting to AV Equipment	52	
■ Connecting to Digital Video Output Terminal (Digital Connection)	52	
■ Connecting to Analog Video Output Terminal (Analog Connection)	53	
■ Outputting Audio to Speakers.....	55	
Starting Projection	56	
■ When the Language Selection Screen Appears.....	57	
■ When the Password Input Screen Appears.....	58	
■ When “No signal” Appears	58	
■ When Notebook Computer Screen Does Not Appear	58	
■ Adjusting Image.....	58	
Changing Notebook Computer Screen Output.....	58	
■ Turning on External Monitor Output.....	58	
Selecting an Input Signal (INPUT)	59	
■ Types of Input Signals	59	
■ Selecting an Input Signal.....	60	
Adjusting the Image.....	61	
Setting the Display Resolution of the Computer.....	61	
■ Windows 7.....	61	
■ Windows Vista.....	61	
■ Windows XP	61	
■ Mac OS X.....	62	
AUTO PC	62	
■ Performing the Auto PC Function.....	62	
Selecting Screen Aspect and Aspect	63	
■ Selecting Screen Aspect	63	
■ Selecting Aspect Ratio.....	69	
Adjusting the Image Size.....	71	
Adjusting the Focus.....	73	
Adjusting the Image Position.....	74	
■ Resetting the Position	75	
Adjusting Keystone Distortion	76	
■ Resetting the Keystone Adjustment.....	77	
Selecting an Image Mode	78	
■ Image Modes	78	
■ How to Select an Image Mode.....	79	
Turning Off the Projector	80	
Useful Functions Available During a Presentation	81	
Useful Functions Available During a Presentation.....	82	
Temporarily Blacking Out an Image.....	BLANK	82
Freezing the Picture	FREEZE	82
Adjusting the Volume	VOL	83
Muting the Sound	MUTE	83
Zooming an Image	D.ZOOM.....	84
Showing the Elapsed Time (WUX5000 / WUX4000)	P-TIMER	85

Setting Functions from Menus.....	87
How to Use Menu	88
■ Menu Configuration	88
■ Basic Menu Operations	90
Setting Display Status	93
Selecting an Image Projection Mode	93
Automatic Display Adjustment (WX6000 / SX6000)	94
Selecting an Input Signal Type (Analog PC)	94
Selecting an Input Signal Type (Component) (WUX5000 / WUX4000)	95
Adjust Input Signal Type (Analog PC) Total Dots	95
Adjust Input Signal Type (Analog PC) Tracking	96
Adjust Input Signal Type (Analog PC) Horizontal Position	96
Adjust Input Signal Type (Analog PC) Vertical Position	97
Adjust Input Signal Type (Analog PC) Horizontal Pixels	97
Adjust Input Signal Type (Analog PC) Vertical Pixels	98
Selecting HDMI Input Level	98
HDMI Color Format	99
Select HDMI Over Scan	100
Performing Progressive Processing	101
Selecting a Menu Position	102
Correcting the Screen Color	103
Reversing Projection	104
No Signal Screen	105
Screen When Blank	106
Selecting a Logo at Startup	106
Selecting Aspect Ratio of Screen	107
Adjusting Keystone Distortion (WX6000 / SX6000)	108
Image Shift Adjustment (WX6000 / SX6000)	108
Selecting an Image Quality	109
Image Adjustment	109
Saving the Desired Image Quality	110
Adjusting the Brightness	111
Adjusting the Contrast	112
Adjusting the Sharpness	113
Performing Gamma Correction	113
Adjusting Color	114
Correcting the Image According to the Ambient Light	115
Noise Reduction	116
Dynamic Gamma	116
Memory Color Correction	117
6-axis Color Adjust (Detailed Color Adjustment)	117
Detailed Gamma Correction	118

Table of Contents

Reducing the Lamp Brightness (WUX4000)	119
Resetting the Image Adjustment Settings	119
Setting Various Functions.....	120
Selecting the Power Management Mode	120
Skip the POWER Button Operation.....	121
Enabling / Disabling the Beep	122
Key Repeat (WX6000 / SX6000).....	122
Prohibiting Operations.....	123
Main Unit and Remote Control Channel Settings.....	124
Selecting a Display Language.....	125
Showing / Hiding the Guide Screen	126
Showing / Hiding the Input Status	127
Selecting the HDMI Input	127
Setting a Password	128
Registering a Password	129
Prohibiting Operation of the Lens (WUX5000 / WUX4000).....	130
Lens Shift Reset.....	131
Extending the Menu Display Time.....	132
Showing / Hiding the High Temperature Warning Icon	133
Reducing Flickering (WUX5000 / WUX4000).....	134
Gamma Restore (WX6000 / SX6000)	134
Lamp Warning Display (WX6000 / SX6000)	135
Resetting the Lamp Counter	135
■ About the Display of the Lamp Counter.....	136
Filter Warning Display (WX6000 / SX6000)	137
Resetting the Air Filter Counter (WX6000 / SX6000).....	137
Displaying Test Pattern (WX6000 / SX6000)	138
Selecting Audio In Terminal (WX6000 / SX6000)	139
Locking Installation Related Functions (WX6000 / SX6000).....	139
Resetting to the Default Setting.....	140
Checking Projector Information	141

Installation Manual (Installation and Maintenance) 143

Installation	145
Installation Precautions.....	146
Precautions When Carrying the Projector.....	146
Installation Precautions	146
Precautions When Carrying and Transporting the Projector.....	146
■ When using mounted on the ceiling	148

■ Install facing in the correct direction	148
Installation Procedure.....	149
Selecting the Projection Method and Installation Location	150
■ Ceiling Mounting or Rear Projection	150
■ Adjusting the projection position when installed on the floor	150
Installing / Removing the Lens Unit	151
■ Installing the Lens Unit	151
■ Removing the Lens Unit	155
Setting Up the Projector	156
■ Positioning the Projector in Front of the Screen	156
■ Relationship Between Image Size and Projecting Distance	156
■ Lens Shift Function	160
Connecting to AV Equipment.....	162
■ Connectable Equipment and Input Terminals.....	162
■ Connection Terminal and Connection Cable	164
Connecting to a Network.....	165
 Preparing the Remote Control	166
Connection Methods.....	166
Setting an IP Address	167
■ Windows 7	167
■ Windows Vista	168
■ Windows XP.....	169
■ Mac OS X.....	170
■ Resetting the IP Address Setting of the Computer.....	170
 Network Settings on the Projector	171
Locking the Network Settings	171
Turning the Network Function On / Off	172
Setting a Network Password.....	173
Registering a Network Password.....	173
Turning the PjLink Function On / Off	174
Turning DHCP Function On / Off	175
TCP / IP Setting	175
Initializing Network Settings.....	176
 Configuring the Network From the Computer	177
■ Displaying and Configuring the Network Configuration Screen.....	177
■ Resetting to Factory Defaults	180
■ Setting Errors.....	180
 Setting Up the Network.....	182
■ Setting Basic Information [Network].....	182
■ Setting Up Email [Mail].....	183
■ Mail Authentication Settings [Mail auth]	184
■ Sending a Test Mail [Send test mail].....	185
■ SNMP Settings [SNMP]	185
■ Setting Projector Information [Projector info.].....	186
■ Setting PjLink [PjLink].....	187

Table of Contents

Controlling the Projector from a Computer.....	188
Error Mail	190
Maintenance	191
Cleaning the Projector.....	192
Cleaning and Replacing the Air Filter	193
Replacing the Air Filter.....	193
Cleaning the Air Filter.....	194
Replacing the Lamp.....	195
Replacement Lamp	196
Replacing the Lamp	196

Appendix 199

Appendix.....	201
Troubleshooting.....	202
LED Indicator Meanings.....	202
Symptoms and Solutions.....	203
■ You Cannot Turn on the Projector.....	203
■ You Cannot Project an Image from the Projector	203
■ There is no Sound.....	204
■ The Projected Image Is Blurred	205
■ You Cannot Project an Image Appropriately	205
■ The Projector Power Turns Off.....	205
■ You Cannot Operate the Remote Control	206
Relationship between Aspect and Screen Aspect.....	207
WUX5000 / WUX4000.....	207
■ When the image is projected on a 16:10 screen.....	207
■ When the image is projected on a 16:9 screen	208
■ When the image is projected on a 4:3 screen	208
■ When projecting on a 16:10 screen in the aspect ratio of the connected device.....	209
■ When projecting on a 16:9 screen in the aspect ratio of the connected device.....	209
■ When projecting on a 4:3 screen in the aspect ratio of the connected device.....	210
WX6000.....	210
■ When the image is projected on a 16:10 screen.....	210
■ When the image is projected on a 16:9 screen	211
■ When the image is projected on a 4:3 screen	211
■ When projecting on a 16:10 screen in the aspect ratio of the connected device.....	212
■ When projecting on a 16:9 screen in the aspect ratio of the connected device.....	212
■ When projecting on a 4:3 screen in the aspect ratio of the connected device.....	213
SX6000.....	213
■ When the image is projected on a 4:3 screen	213
■ When the image is projected on a 16:10 screen.....	214
■ When the image is projected on a 16:9 screen	214
■ When projecting on a 4:3 screen in the aspect ratio of the connected device.....	215





- When projecting on a 16:10 screen in the aspect ratio of the connected device..... 215
- When projecting on a 16:9 screen in the aspect ratio of the connected device..... 216
- Displayed Test Patterns.....217**
- Supported Signal Types218**
- Product Specifications219**
 - Projector 219
 - Remote control 221
 - Specification of Each Lens Unit (Option) 221
 - External View 223
 - ANALOG PC (WUX5000 / WUX4000), ANALOG PC-1 (WX6000 / SX6000) /
COMPONENT IN Terminal 223
 - Service Port (CONTROL)..... 224
- Index228**
- Menu Configuration232**

Safety Instructions

Before installing and operating the projector, read this manual thoroughly. This projector provides many convenient features and functions. Operating the projector properly enables you to manage those features and maintain it in good condition for many years to come.

Improper operation may result in not only shortening the product life, but also malfunctions, fire hazards, or other accidents.

If your projector does not seem to be operating properly, read this manual again, check operations and cable connections, and try the solutions in the “Troubleshooting” section in the back of this manual. If the problem still persists, contact the Canon Customer Support Center.

	CAUTION RISK OF ELECTRIC SHOCK DO NOT OPEN	
CAUTION: TO REDUCE THE RISK OF ELECTRIC SHOCK, DO NOT REMOVE COVER (OR BACK). NO USER-SERVICEABLE PARTS INSIDE EXCEPT LAMP REPLACEMENT. REFER SERVICING TO QUALIFIED SERVICE PERSONNEL.		
	THIS SYMBOL INDICATES THAT DANGEROUS VOLTAGE CONSTITUTING A RISK OF ELECTRIC SHOCK IS PRESENT WITHIN THIS UNIT.	
	THIS SYMBOL INDICATES THAT THERE ARE IMPORTANT OPERATING AND MAINTENANCE INSTRUCTIONS FOR THIS UNIT IN THE OWNER'S MANUAL.	

CAUTION Not for use in a computer room as defined in the Standard for the Protection of Electronic Computer / Data Processing Equipment, ANSI / NFPA 75.
--

Safety Precautions

WARNING:

- **THIS APPARATUS MUST BE GROUNDED.**
- **TO REDUCE THE RISK OF FIRE OR ELECTRIC SHOCK, DO NOT EXPOSE THIS APPLIANCE TO RAIN OR MOISTURE.**
- This projector produces intense light from the projection lens. Do not stare directly into the lens, otherwise eye damage could result. Be especially careful that children do not stare directly into the beam.
- Install the projector in a proper position. Otherwise it may result in a fire hazard.
- Allowing the proper amount of space on the top, sides, and rear of the projector cabinet is critical for proper air circulation and cooling of the unit. The diagrams shown here indicate the minimum space required. If the projector is to be built into a compartment or similarly enclosed, these minimum distances must be maintained.

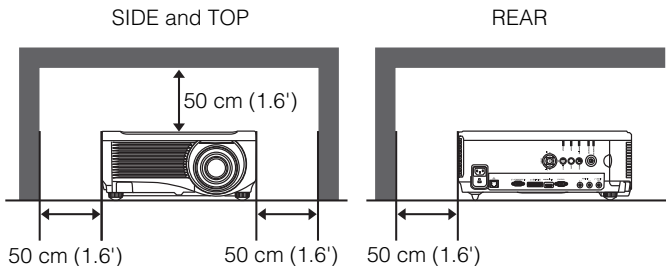

- Do not cover the ventilation slots on the projector. Heat build-up can reduce the service life of your projector, and can also be dangerous.
- If the projector is unused for an extended time, unplug the projector from the power outlet.
- Do not project the same image for a long time. An afterimage may remain on the LCD panels due to the characteristics of the panels of the projector.

CAUTION ON HANGING FROM THE CEILING

When hanging the projector from the ceiling, clean the air intake vents and top of the projector periodically with a vacuum cleaner. If you leave the projector unclean for a long time, the cooling fans can be clogged with dust, and it may cause a breakdown or a disaster.

DO NOT SET THE PROJECTOR IN GREASY, WET, OR SMOKY CONDITIONS SUCH AS IN A KITCHEN TO PREVENT A BREAKDOWN OR A DISASTER. IF THE PROJECTOR COMES IN CONTACT WITH OIL OR CHEMICALS, IT MAY BECOME DETERIORATED.

Safety Instructions

■ READ AND KEEP THIS OWNER'S MANUAL FOR LATER USE.

All the safety and operating instructions should be read before beginning to operate the product.

Read all of the instructions given here and retain them for later use. Unplug this projector from the AC power supply before cleaning. Do not use liquid or aerosol cleaners on the projector. Use a damp cloth for cleaning.

Follow all warnings and instructions marked on the projector.

For added protection of the projector during a lightning storm, or when it is left unattended or unused for long periods of time, unplug it from the wall outlet. This will prevent damage due to lightning and power surges.

Do not expose this unit to rain or use near water... for example, in a wet basement, near a swimming pool, etc...

Do not use attachments not recommended by the manufacturer as they may result in hazards.

Do not place this projector on an unstable cart, stand, or table. The projector may fall, causing serious injury to a child or adult, and serious damage to the projector. Use only with a cart or stand recommended by the manufacturer, or sold with the projector. Wall or shelf mounting should be carried out in accordance with the manufacturer's directions, and should use a mounting kit approved by the manufacturers.

An appliance and cart combination should be moved with care.

Sudden stops, excessive force, and uneven surfaces may cause the appliance and cart combination to overturn.



Slots and openings in the rear and front of the cabinet are provided for ventilation, to insure reliable operation of the equipment and to protect it from overheating.

The openings should never be covered with cloth or other materials, and the bottom opening should not be blocked by placing the projector on a bed, sofa, rug, or other similar surface. This projector should never be placed near or over a radiator or heat register.

This projector should not be placed in a built-in installation such as a book case unless proper ventilation is provided.

Never push objects of any kind into this projector through cabinet slots as they may touch dangerous voltage points or short out parts that could result in a fire or electric shock. Never spill liquid of any kind onto the projector.

Do not install the projector near the ventilation duct of air-conditioning equipment.

This projector should be operated using only the type of power source indicated on the marking label. If you are not sure of the type of power supplied, contact the Canon Customer Support Center or local power company.

Do not overload wall outlets and extension cords as this can result in fire or electric shock. Do not allow anything to rest on the power cord. Do not locate this projector where the cord may be damaged by people walking on it.

Do not attempt to service this projector yourself as opening or removing covers may expose you to dangerous voltages or other hazards. Refer all servicing to qualified service personnel.

Unplug this projector from the wall outlet and refer servicing to qualified service personnel under the following conditions:

- a. When the power cord or plug is damaged or frayed.
- b. If liquid has been spilled into the projector.
- c. If the projector has been exposed to rain or water.
- d. If the projector does not operate normally after following the operating instructions. Adjust only those controls that are covered in the operating instructions as improper adjustment of other controls may result in damage and will often require extensive work by a qualified technician to restore the projector to normal operating condition.
- e. If the projector has been dropped or the cabinet has been damaged.
- f. When the projector exhibits a distinct change in performance-this indicates a need for servicing.

When replacement parts are required, be sure the service technician uses replacement parts specified by the manufacturer that have the same characteristics as the original parts. Unauthorized substitutions may result in fire, electric shock, or injury.

Upon completion of any service or repairs to this projector, ask the service technician to perform routine safety checks to determine that the projector is in safe operating condition.

AC Power Cord Requirement

The AC Power Cord supplied with this projector meets the requirements for use in the country you purchased it.

AC Power Cord for the United States and Canada:

The AC Power Cord used in the United States and Canada is listed by the Underwriters Laboratories (UL) and certified by the Canadian Standard Association (CSA).

The AC Power Cord has a grounding-type AC line plug. This is a safety feature to ensure the plug fits into the power outlet. Do not try to tamper with this safety feature. Should you be unable to insert the plug into the outlet, contact your electrician.

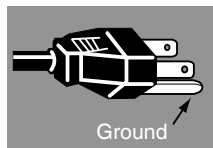

THE SOCKET-OUTLET SHOULD BE INSTALLED NEAR THE EQUIPMENT AND EASILY ACCESSIBLE.

NOTE FOR CUSTOMERS IN THE US

 LAMP(S) INSIDE THIS PRODUCT CONTAIN MERCURY AND MUST BE RECYCLED OR DISPOSED OF ACCORDING TO LOCAL, STATE OR FEDERAL LAWS.



European Union (and EEA) only.

These symbols indicate that this product is not to be disposed of with your household waste, according to the WEEE Directive (2002/96/EC), the Battery Directive (2006/66/EC) and / or your national laws implementing those Directives. If a chemical symbol is printed beneath the symbol shown above, in accordance with the Battery Directive, this indicates that a heavy metal (Hg = Mercury, Cd = Cadmium, Pb = Lead) is present in this battery or accumulator at a concentration above an applicable threshold specified in the Battery Directive. This product should be handed over to a designated collection point, e.g., on an authorized one-for-one basis when you buy a new similar product or to an authorized collection site for recycling waste electrical and electronic equipment (EEE) and batteries and accumulators. Improper handling of this type of waste could have a possible impact on the environment and human health due to potentially hazardous substances that are generally associated with EEE. Your cooperation in the correct disposal of this product will contribute to the effective usage of natural resources. For more information about the recycling of this product, please contact your local city office, waste authority, approved scheme or your household waste disposal service or visit www.canon-europe.com/environment.



(EEA: Norway, Iceland and Liechtenstein)

Federal Communication Commission Notice

Multimedia Projector, Model: WUX5000 / WUX4000 / WX6000 / SX6000

This device complies with Part 15 of the FCC Rules. Operation is subject to the following two conditions:

- (1) This device may not cause harmful interference, and
- (2) this device must accept any interference received, including interference that may cause undesired operation.

Note: This equipment has been tested and found to comply with the limits for a Class B digital device, pursuant to Part 15 of the FCC Rules. These limits are designed to provide reasonable protection against harmful interference in a residential installation. This equipment generates, uses and can radiate radio frequency energy and, if not installed and used in accordance with the instructions, may cause harmful interference to radio communications. However, there is no guarantee that interference will not occur in a particular installation. If this equipment does cause harmful interference to radio or television reception, which can be determined by turning the equipment off and on, the user is encouraged to try to correct the interference by one or more of the following measures:

- Reorient or relocate the receiving antenna.
- Increase the separation between the equipment and receiver.
- Connect the equipment into an outlet on a circuit different from that to which the receiver is connected.
- Consult the dealer or an experienced radio / TV technician for help.

The cable with a ferrite core provided with the projector must be used with this equipment in order to comply with Class B limits in Subpart B of Part 15 of the FCC rules. Use of a shielded cable is required to comply with class B limits in Subpart B of Part 15 of FCC Rules.

Do not make any changes or modifications to the equipment unless otherwise specified in the instructions. If such changes or modifications should be made, you could be required to stop operation of the equipment.

Canon U.S.A. Inc.

One Canon Plaza, Lake Success, NY 11042-1198, U.S.A.

Tel No. (516) 328-5600

Canadian Radio Interference Regulations

This Class B digital apparatus complies with Canadian ICES-003.

Precautions for Use

As this section contains important safety-related information, be sure to read the following carefully beforehand in order to use your projector correctly and safely.

Warning

If the following situations occur, turn the power off, remove the power plug from the power outlet and contact the Canon Customer Support Center. Failure to do so could cause a fire or result in an electric shock.

- If smoke is emitted
- If an unusual smell or noise is emitted
- If a loud noise is heard and the lamp turns off
- If water or other liquid has entered the projector
- If metal or any other foreign material has entered the projector
- If the projector is knocked over or dropped and the cabinet is damaged

Warning

Pay attention to the following points for handling the power cord. Failing to pay attention to these points could cause a fire, electric shock or personal injury.

- Do not place any objects on the power cord and do not allow it to become trapped under the projector. The power cord may be damaged.
- Do not cover the power cord with a carpet.
- Do not excessively bend, twist, pull or make modifications to the power cord.
- Keep the power cord away from heaters and other sources of heat.
- Do not use the power cord when it is bent finely, coiled or bundled.
- Do not use a damaged power cord. If your power cord is damaged, contact the Canon Customer Support Center.
- Do not use any power cord other than the type that is included with this projector.
- Be sure to connect the ground wire of the power cord to ground. Failure to do so could result in an electric shock.
- Be sure to connect the ground wire before connecting the power plug to the outlet. Also when you disconnect the ground wire, be sure to unplug the power plug from the outlet beforehand.

Warning

Pay attention to the following points regarding the power source, power plug and handling of the connector. Failure to do so could result in a fire, electric shock or personal injury.

- Do not use any power source with a voltage other than the voltage indicated (AC 100 – 240 V).
- Do not pull the power cord and be sure to hold the power plug or connector when removing. The cord could be damaged as a result.
- Do not insert any metal objects into the contact parts of the power plug or connector.
- Remove the power plug from the outlet before performing cleaning or maintenance of the projector.
- Do not remove the power plug or connector with wet hands.
- Insert the power plug and connector securely up to the base. Additionally, do not use a damaged power plug or an outlet that is loose.
- If using an extension cord attached to the outlet, make sure that the total electric power consumption of connected devices does not exceed the rated capacity.
- Periodically inspect the power plug and outlet and remove any dust or dirt from between the plug and the outlet.

Precautions for Installation

Warning

Pay attention to the following points regarding installation and handling of the projector. Failure to do so may cause a fire, electric shock or personal injury.

- Do not use the projector in a bathroom or shower room.
- Do not use the projector in rain or snow, by the sea, or in close proximity to a body of water.
- Do not place containers containing a liquid on top of the projector.
- Do not place the projector in any location where it will be exposed to oily smoke or steam, such as a kitchen work surface or table etc.
- Do not touch the projector itself, the power cord, or the cable if lightning strikes.

Warning

Pay attention to the following points regarding installation and handling of the projector. Failure to do so may cause a fire, electric shock or personal injury.

- Do not move the projector until you have switched off the power, removed the power plug from the power outlet and unplugged any other cables.
- Before installing or replacing a lens unit, make sure to remove the power plug from the outlet. Failure to do so could result in an electric shock or injury.
- Do not remove the cabinet from the projector or disassemble it. The interior of the projector contains high-voltage components as well as parts that are hot. These could cause an electric shock or burn. If inspection, maintenance or repair is required, contact the Canon Customer Support Center.
- Do not disassemble or modify the projector (including consumable parts) or the remote control.
- Do not insert any object into vents in the projector, such as the air intake vent or exhaust vents.
- Do not place a pressurized can in front of the exhaust vents. The pressure of the contents of the can may increase due to heat from the exhaust vents and this could result in an explosion.
- As strong light beams are emitted while the projector is in use, do not look directly into the projector lens. Doing so could cause an eye injury. Pay particular attention in preventing young children to do so.
- When giving a presentation in front of the projector while it is projecting an image, conduct your presentation from a position where your shadow will not be cast on the screen and where you do not feel blinded by light from the projector.

Caution

Pay attention to the following points regarding installation and handling of the projector.

- If the projector will not be used for a long period of time, be sure to remove the power plug from the power outlet to ensure safety. Failure to do so could cause a fire.
- The temperature of the cabinet around and above the exhaust vents can become hot during projector operation. Touching these areas during operation could cause burns to the hands.
Do not touch these areas. Doing so may cause burns. Pay particular attention in preventing young children from touching these parts. Additionally, do not place any metal objects on these areas. Due to the heat from the projector, doing so could cause an accident or personal injury.

Caution

Pay attention to the following points regarding installation and handling of the projector.

- Do not place any heavy objects on top of the projector or sit / stand on it. Pay particular attention to prevent small children from doing so. The projector may be knocked over and this could result in damage or a personal injury.
- Do not place the projector on an unstable or slanted surface. Doing so may cause the projector to fall or be knocked over and could result in a personal injury.
- Do not place any objects in front of the lens while the projector is operating. Doing so could cause a fire.
- When cleaning off dust or dirt from the projector lens etc., do not use any kind of spray that is flammable. As the temperature of the lamp inside the projector is high, it could ignite, causing a fire.
- Using the lens shift function the lens in the projector moves up / down / left / right powered by a motor. Do not touch the lens when the lens is moving. Doing so could cause a personal injury.
- Before replacing the lens unit, wait at least one hour after the projector is turned off to allow the projector to cool thoroughly. Failure to do so could result in a burn or injury.
- If the projector is used for a long period of time, dust could accumulate inside the projector. This could cause a fire or malfunction. It is recommended that periodic maintenance of the projector be performed. For details of maintenance costs, contact the Canon Customer Support Center.
- When hanging the projector from a ceiling, put the projector down on the floor or a workbench before attaching or replacing the lens unit. Failure to do so could result in parts falling off the projector and may cause an accident or personal injury.

Precautions on the lamp

Warning

When replacing the lamp, or when the lamp is damaged, pay attention to the following points. Failure to do so could result in an electric shock or personal injury.

- Be sure to remove the power plug from the power outlet before replacing the lamp.
- When the lamp is damaged, shards of glass may be scattered inside the projector. Contact the Canon Customer Support Center for cleaning and inspection of the projector interior and lamp replacement.

Caution

When handling the lamp, pay attention to the following points.

- Be sure not to handle the lamp immediately after it has been used. Be sure to switch off the power and wait for approximately 1 hour for the lamp and the projector to cool down sufficiently. Failure to do so could result in a burn or personal injury due to heat from the lamp or projector.
- When an instruction to replace the lamp has been displayed (LAMP Indicator Displays (P39)), the possibility of the lamp breaking will increase. Replace the lamp with a new one as soon as possible.
- If the lamp is damaged, gas inside the lamp (containing mercury) and dust may be emitted from the exhaust vents. If this happens, immediately open the windows and doors to provide ventilation to the room. If you inhale any gas emitted from the lamp or it has come into contact with your eyes or mouth, consult a doctor immediately.
- When disposing of a used mercury lamp, dispose of it in the same way as a fluorescent lamp and in accordance with the local regulations where you live.

Precautions for the batteries of the remote control

Warning

Pay attention to the following points regarding handling of batteries. Failure to do so could result in a fire or injury.

- Do not place the batteries in a fire or apply heat to, short circuit or disassemble the batteries.
- Do not attempt to recharge the batteries that are included with the remote control.
- Remove the batteries when they have been fully used, or if they will not be used for a long period of time.
- When replacing the batteries, replace both at the same time. Also, do not use two batteries of a different type at the same time.
- Insert the batteries in the correct + / - positions.
- If any liquid leaks from the batteries and comes into contact with skin, wash off thoroughly with water.

For Safe Use

Pay attention to the following points when carrying or transporting the projector.

- This projector is a precision instrument. Do not knock it over or subject it to impacts. Doing so may cause a malfunction.
- When carrying or holding up the projector after attaching the lens unit, be sure not to hold the lens. Doing so may cause damage to the lens unit.
- Do not reuse any packaging or shock-absorbent materials that were supplied with the projector at the time of purchase for transporting or shipping the projector. Protection of the projector cannot be guaranteed if used packaging or shock-absorbent materials are reused. Fragments from shock-absorbent material may also enter the interior of the projector which could cause a malfunction.
- If transportation is necessary, the lens unit should be removed before transporting the projector. If the projector is subjected to excessive impacts during transportation, the lens unit may be damaged. Removal and installation of the lens unit should not be performed by the user. Be sure to have the procedure performed by a qualified technician or contact the Canon Customer Support Center.

For Safe Use

Pay attention to the following points when installing or using the projector.

- Be sure to install the projector in a location where the air intake and exhaust vents are separated from the wall by more than 50 cm (1.6'). Failure to do so could cause a malfunction.
- Do not install the projector in a location that is damp, or where there is a lot of dust, oily smoke or tobacco smoke. Doing so could cause contamination of optical components such as the lens and the mirror and may result in deterioration of image quality.
- Do not touch the lens with bare hands. Doing so may result in deterioration of image quality.
- If the projector is suddenly moved from a location where the temperature is low to a location where the temperature is high, or if the temperature in the location where the projector is installed increases suddenly, moisture in the air could cause condensation to form on the projector lens or mirror. This may cause a blurred image. Wait until the condensation has evaporated for the image projected to return to normal.
- Do not install the projector in a location where the temperature is high or low. Doing so may cause a malfunction.

Operating temperature: 5°C to 35°C Humidity level: up to 85%

Storage temperature: -10°C to 60°C

- Do not install the projector near high-voltage electrical power lines or an electrical power source.
- Do not use the projector on a soft surface such as carpet or sponge mat, etc. Doing so could cause heat to build up inside the projector and this could result in a malfunction.
- Do not block the air intake or exhaust vents of the cooling fan. Doing so could cause heat to build up inside the projector and may cause a malfunction.
- Installing the projector in the wrong direction may cause a malfunction or accident. Install the projector so that the left / right incline is within 10°.
- Do not place any objects on top of the projector that may change shape or color due to heat.
- When using the projector at altitudes greater than 2,300 m, or for projecting upward / downward:

When using the projector at altitudes greater than 2,300 m, or for upward projection or downward projection, it is necessary to change the settings of the projector. For further details, contact the Canon Customer Support Center.

Before Use

Table of Contents

Safety Instructions

Before Use

Projecting an Image

Useful Functions Available
During a Presentation

Setting Functions from Menus

Installation

Connecting to a Network

Maintenance

Appendix

Index

User's Manual

Installation Manual

Appendix

Supplied Accessories

Check that the following accessories have been supplied with the projector.

- Remote control

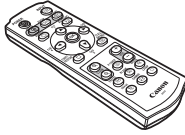

(part No.: RS-RC04)

WUX5000 / WUX4000

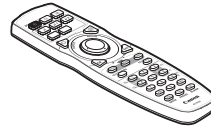

(part No.: RS-RC05)

WX6000 / SX6000

- Batteries for the remote control



(AAA size x2)

WUX5000 / WUX4000

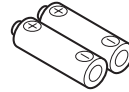

(AA size x2)

WX6000 / SX6000

- Power cord (1.8 m)

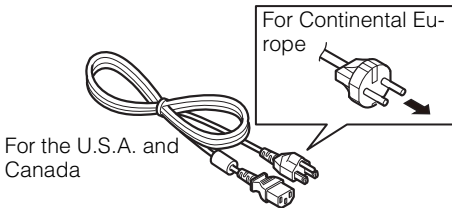

- VGA cable (1.8 m) for connection to a computer (part No.: YH7-2307) (mini D-sub 15-pin / mini D-sub 15-pin)

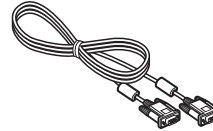

- User's Manual / Installation Manual (CD-ROM)



- Warranty Card
- Important Information

■ Installing Remote Control Batteries

WUX5000 / WUX4000

- 1** Open the battery compartment lid. Slide the lid while pressing it down.

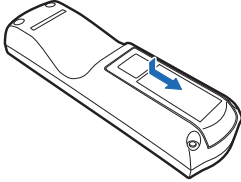

- 2** Insert batteries. Insert 2 new AAA batteries in the compartment with the + and - poles positioned correctly.

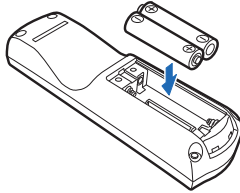

- 3** Close the compartment lid. Slide the lid until you hear a click to securely close it.

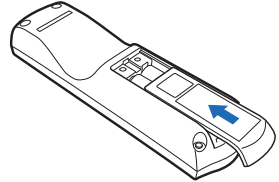

WX6000 / SX6000

- 1** Open the battery compartment lid. Raise the battery cover tab while pushing it.

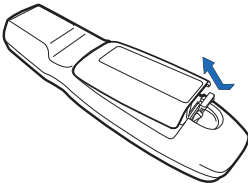

- 2** Insert batteries. Insert 2 new AA batteries in the compartment with the + and - poles positioned correctly.

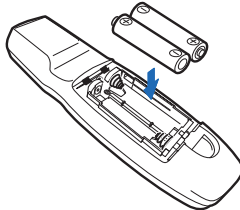

- 3** Close the compartment lid. Insert the tab into the remote control notch (1) and push the battery cover down (2).

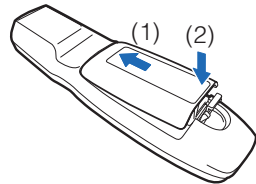

- If buttons on the remote control are inoperative when you attempt to operate the projector, replace the batteries with new ones.
- Do not drop the remote control or subject it to impact.
- Do not spill any liquids on the remote controller. Doing so could damage it.

Supplied Accessories



Pay attention to the following points when handling the batteries. Failing to do so could result in a fire or personal injury.



Prohibition

- Do not heat, short circuit or disassemble the batteries, or place them in a fire.
- Do not attempt to recharge the batteries that are included with the remote control.



Caution

- Remove the batteries when they are flat or when the remote control will not be used for a long period of time.
- When replacing the batteries, replace both batteries at the same time and do not use two batteries of a different type together.
- Insert the batteries with the + and - terminals in the correct directions.
- If any liquid from inside the batteries leaks out and contacts your skin, be sure to wash the liquid off thoroughly.

Preparing the Remote Control

■ Remote Control Operating Range

The remote control is an infrared type. Point it at the infrared remote receiver on the front or rear of the projector to operate it.

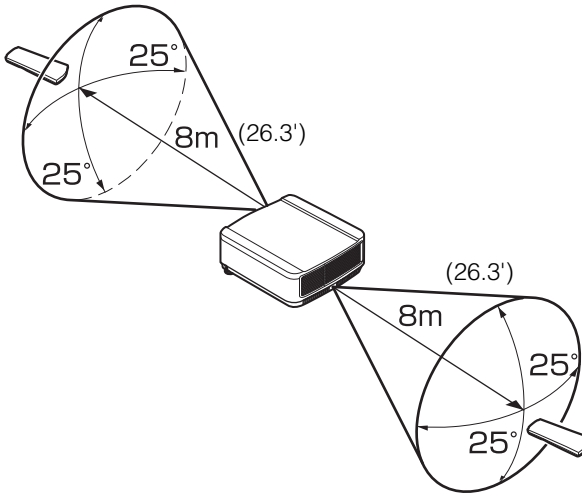

Before Use



- Use the remote control within a distance of approximately 8 m (26.3') from the projector.
- Use the remote control within an angle of 25° in any direction from directly in front of the infrared remote receiver.
- The remote control may be inoperative if there is an obstacle between the remote control and main unit or the infrared remote receiver on the main unit is exposed to direct sunlight or strong light of lighting equipment.
- When you use 2 or more projectors at the same time, you can change the channel settings to prevent the 2 remote controls from interfering with each other. (P124)

Preparing the Remote Control

■ When a remote control is connected using a cable (WX6000 / SX6000)

The remote control for WX6000 / SX6000 (RS-RC05) can be used connected to the projector with a cable.

Use a cable with a Ø3.5 mm stereo mini jack (not included).

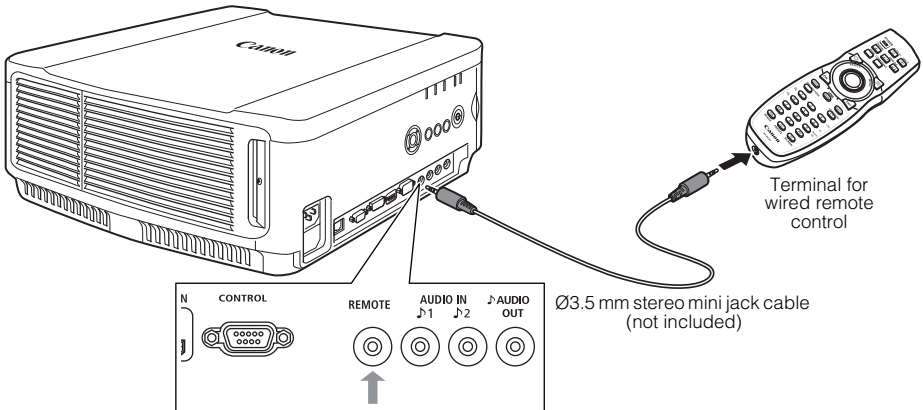

- Infrared operations cannot be performed if a cable is connected to the projector or the remote control.
- Use a cable with a Ø3.5 mm stereo mini jack (not included) with a length of 30 m or less.

Part Names

Main Unit (The illustration shows WUX5000.)

■ Front Side

Power cord connector (P56)

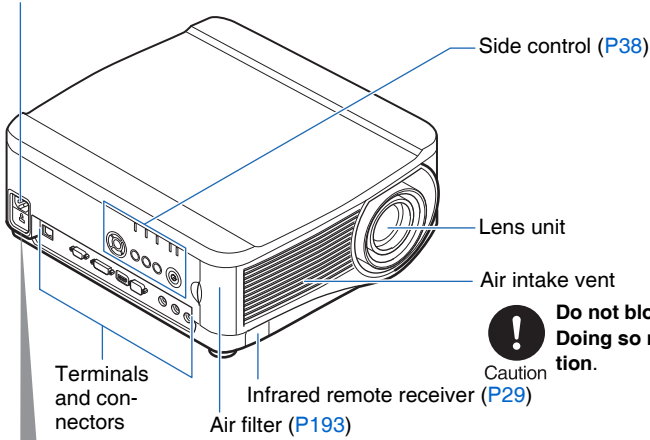

Do not block the air intake.
Doing so may cause a malfunction.

Caution



Anti-theft lock hole

An anti-theft wire cable (not included) can be connected.

Part Names

■ Rear Side

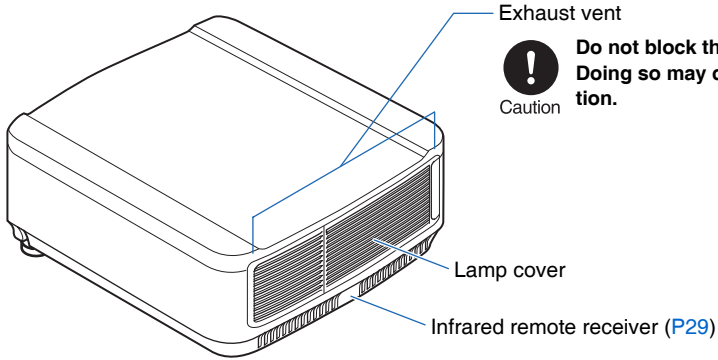

■ Bottom Side

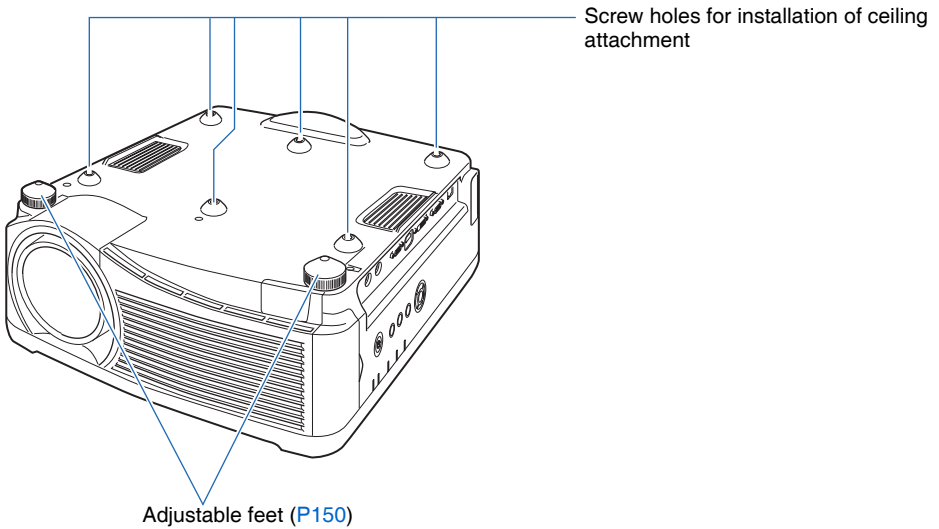

Mounting the Projector on the Ceiling

You can mount the projector on the ceiling. The ceiling attachment (part No.: RS-CL11) is required in order to mount the projector on the ceiling. Depending on the installation environment, an extension pipe (part No.: RS-CL08 or RS-CL09) may also be required. Contact the Canon Customer Support Center for more detailed information.



Caution

- **Make sure to use the optional ceiling attachment.**
- **You should never install the ceiling attachment by yourself.**



If you mount the projector on the ceiling, you have to invert the projected image by selecting [Image flip H/V] from the menu. (P104)

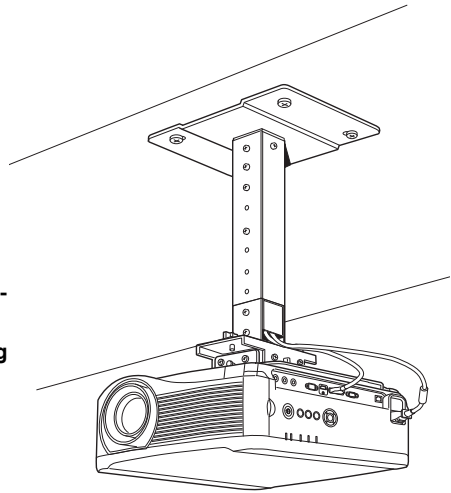

Remote Control

The projector can be operated using buttons on the remote control or the side control on the main unit. The RS-RC04 remote control is included with WUX5000 / WUX4000 and the RS-RC05 remote control is included with WX6000 / SX6000.

The remote control allows you to operate all functions of the projector.

■RS-RC04

WUX5000 / WUX4000

POWER button (P56, P80)

Turns the projector on or off.

FOCUS button (P73)

Adjusts focusing.

[▲] / [▶] buttons: Moves the focus position farther away.

[▼] / [◀] buttons: Moves the focus position nearer.

ASPECT button (P70)

Changes the aspect ratio mode.

D.SHIFT/KEystone button (P76)

Corrects keystone distortion.

[▲], [▼], [◀] / [▶] buttons: For keystone adjustment.

Press D.SHIFT/KEystone to correct keystone distortion.

- Moves the image up, down, left, or right when the screen aspect setting is [16:9 D. image shift] or [4:3 D. image shift] is selected. (P67, P68)

- To move the image, use the [▲] / [▼] or the [◀] / [▶] buttons.

D. ZOOM button (P84)

Zooms the image in or out digitally.

[+] button: Zooms the image in (up to 12x).

[-] button: Zooms the image out (1x minimum).

[▲], [▼], [◀] / [▶] buttons: Move the zoom-in location.

FREEZE button (P82)

Freezes the projected image.

IMAGE button (P79)

Switches the image mode (image quality).

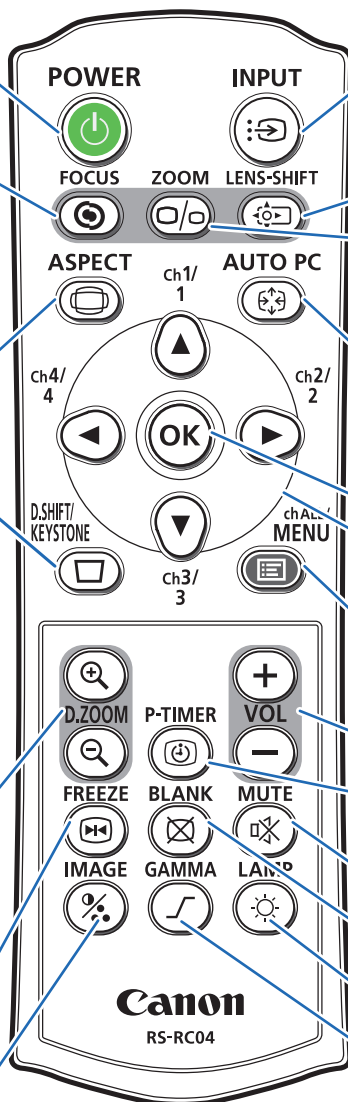

INPUT button (P60)

Switches the input signal.

ZOOM button (P71)

Adjusts the image size.

[▲] / [▶] buttons: Increase the image size.

[▼] / [◀] buttons: Decrease the image size.

AUTO PC button (P62)

Adjusts tracking etc. automatically in accordance with the signal from a computer when the analog PC input is selected.

LENS-SHIFT button (P74)

Moves the lens up, down, left, or right.

[▲], [▼], [◀] / [▶] buttons: Move the lens.

OK button (P92)

Confirms the item selected from the menu.

Pointer buttons (P90)

Selects the upper, lower, left or right item in the menu and performs remote control channel settings. (P127)

MENU button (P88)

Displays the menu on the screen and performs remote control channel settings.

VOL button (P83)

Adjusts the sound volume.

[+] button: Increases the volume.

[-] button: Decreases the volume.

P-TIMER button (P85)

Displays the time elapsed since this button was pressed.

MUTE button (P83)

Mutes the sound.

BLANK button (P82)

Toggles between display / non-display of image.

LAMP button (WUX4000) (P119)

Toggles the lamp mode between Standard and Silent.

GAMMA button (P113)

Adjusts the gamma of the image.

[▶] button: Corrects dark parts of the image so that they are easier to see.

[◀] button: Corrects bright parts of the image so that they are easier to see.

Part Names

■RS-RC05

WX6000 / SX6000

POWER button (P56, P80)

Turns the projector on or off.

ASPECT button (P70)

Changes the aspect ratio mode.

Pointer buttons (P90)

Selects the upper, lower, left or right item in the menu. Performs remote control channel settings when the remote control is used via the infrared transmitter. (P124)

OK button (P92)

Determines the item selected from the menu.

ZOOM button (P71)

Adjusts the image size.

[▲] / [▶] buttons: Increase the image size.

[▼] / [◀] buttons: Decrease the image size.

FOCUS button (P73)

Adjusts focusing.

[▲] / [▶] buttons: Moves the focus position further away.

[▼] / [◀] buttons: Moves the focus position nearer.

TEST PATTERN button (P138, P217)

Displays the test pattern.

D.ZOOM button (P84)

Zooms the image in or out digitally.

[1] button: Zooms the image in (up to 12x).

[4] button: Zooms the image out (1x minimum).

[▲] / [▼] / [◀] / [▶] buttons: Move the zoom-in location.

Ch button (P124)

Changes the remote control channel when the remote control is used via the infrared transmitter.

IMAGE button (P79)

Switches the image mode (image quality).

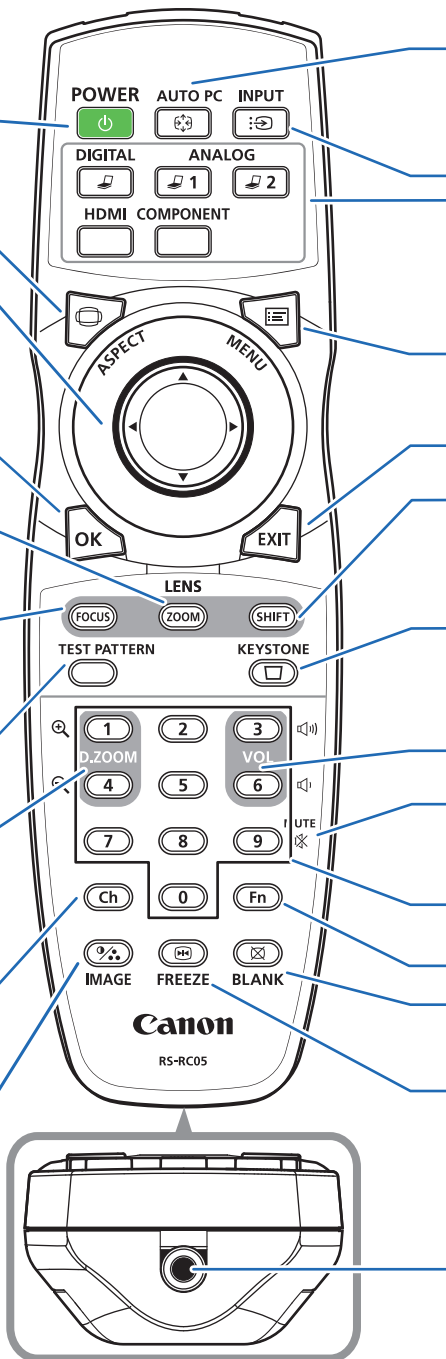

AUTO PC button (P62)

Adjusts tracking etc. automatically in accordance with the signal from a computer when the analog PC input is selected.

Change input buttons (P60)

Change the input signal between Digital PC, Analog PC-1, Analog PC-2, HDMI and Component.

INPUT button (P60)

Switches the input signal.

MENU button (P89)

Displays the menu on the screen. Performs remote control channel settings when the remote control is used via the infrared transmitter. (P127)

EXIT button (P92)

Cancels functions such as menu display or test pattern during operation and returns to the image display.

SHIFT button (P74)

Moves the lens up, down, left or right.
[▲] / [▼] / [◀] / [▶] buttons: Move the lens.

KEYSTONE button (P76)

Corrects keystone distortion.
To move the image, use the [▲] / [▼] or [◀] / [▶] buttons.

VOL button (P83)

Adjusts the sound volume.
[3] button: Increases the volume.
[6] button: Decreases the volume.

MUTE button (P83)

Mutes the sound.

Numerical buttons (P129, P173, P175)

Enter password and TCP/IP setting values.

Fn button

Cannot be used on this product.

BLANK button (P82)

Toggles between display / non-display of the image.

FREEZE button (P82)

Freezes the projected image.

Terminal for wired remote control (P30)

Connects a cable to the projector for remote control operation.

Side Control

(1) LED indicators (P39)

The projector status is shown by the LED indicators (off / on / flashing).
For indicator status, refer to [page 39](#).

- POWER ON (green): Lights up or flashes when the power is on.
- STAND BY (red) : Lights up or flashes during standby or when the projector is shut down.
- WARNING (red) : Lights up or flashes when an error occurs.
- LAMP (orange) : Flashes when the time for replacing the lamp is near. When a lamp cover error occurs, the [WARNING] indicator will also flash. When a lamp error occurs, it will illuminate at the same time as the [WARNING] indicator.
- TEMP (red) : When the temperature inside the projector is high, it will flash. If the temperature inside the projector increases further and a temperature error occurs, it will illuminate at the same time that the [WARNING] indicator illuminates.

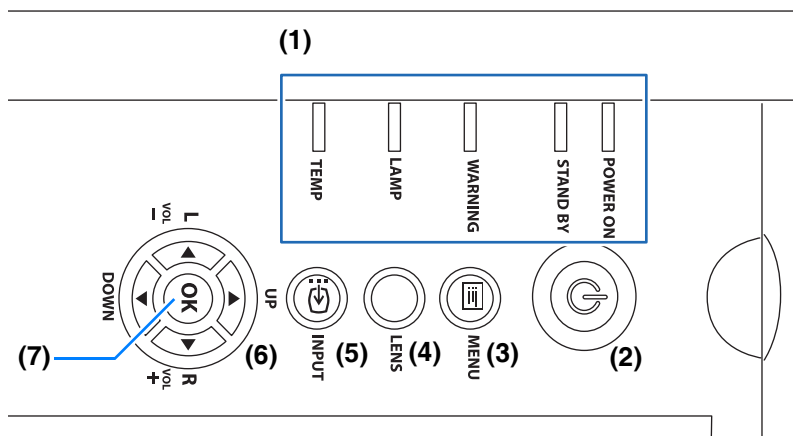

(2) **POWER button (P56, P80)**
Turns the projector on or off.

(5) **INPUT button (P60)**
Switches the input signal.

(3) **MENU button (P88, P89)**
Displays a menu on the screen.

(6) **Pointer / VOL buttons (P90)**
Adjust the sound volume.
[◀] button: Decreases the volume.
[▶] button: Increases the volume.
Selects the upper, lower, left or right item in the menu.



















































(4) **LENS button**
Each time the button is pressed, the screen changes to focus adjustment (P73), zoom (image size) adjustment (P71), or lens shift (image position) adjustment (P74). To adjust, use the [▲] / [▼] or the [◀] / [▶] buttons.

(7) **OK button (P92)**
Determines the item selected from the menu.

LED Indicator Displays

The LED indicators flash or illuminate to indicate the operating status of the projector.

: Off : Lit : Flashing

LED indicator					Operating status
POWER ON (green)	STAND BY (red)	WARN-ING (red)	LAMP (orange)	TEMP (red)	
					Power is not connected.
					Ready to turn power on (standby).
					Power is on.
					Power-saving mode engaged.
 *	 *				The time for replacing the lamp is near.
					Internal temperature is high.
					A lamp error has occurred.
					Power was turned off due to high internal temperature.
					The lamp cover is open.
					Another error has occurred.

* Either the [POWER ON] or [STAND BY] indicator illuminates, depending on the power status.

Input Terminal

WUX5000 / WUX4000

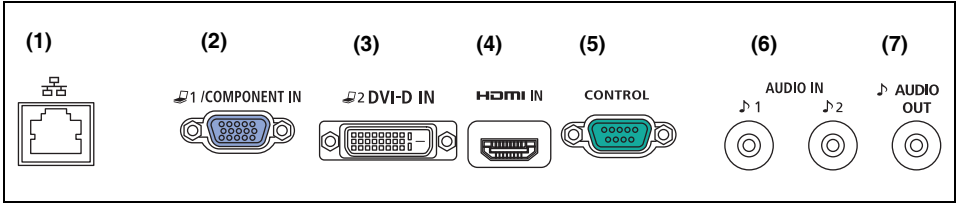

(1) LAN port (P166)

Connects the LAN cable.

Used to connect the projector to a network.

(2) ANALOG PC / COMPONENT IN terminal

(1 / COMPONENT IN) (P47, P53)

Receives the analog PC signal (Analog PC).

A component cable can be used to receive the component image signal (Component).

(3) DVI-D IN terminal (2 DVI-D IN) (P50)

Connects the external monitor output from a computer.

Receives the digital signal (Digital PC).

(4) HDMI IN terminal (HDMI IN) (P51)

Receives the digital content image signal (HDMI).

Carries both video and audio signals across a single cable.

(5) Service port (CONTROL)

This terminal is used by servicing technicians. It is not used during ordinary use.

(6) AUDIO IN terminal (AUDIO IN) (P47, P50, P53)

Receives the audio input corresponding to 2 image input systems other than HDMI IN.

The internal speaker outputs the audio for the selected image signal.

(7) AUDIO OUT terminal (AUDIO OUT) (P51, P55)

Outputs the audio to external AV equipment. This outputs the audio signal that corresponds to the projected image signal.

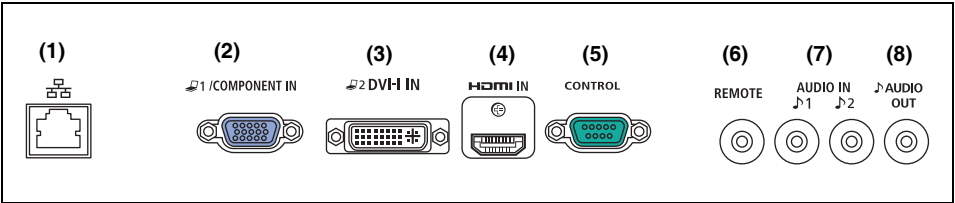
WX6000 / SX6000**(1) LAN port (P166)**

Connects the LAN cable.
Used to connect the projector to a network.

**(2) ANALOG PC-1 / COMPONENT IN terminal
(1 / COMPONENT IN) (P47, P53)**

Receives the analog PC signal (Analog PC-1).
A component cable can be used to receive the component image signal (Component).

(3) ANALOG PC-2 / DVI-I IN terminal (2 DVI-I IN) (P50)

Connects the external monitor output from a computer.
Receives the digital PC signal (Digital PC) or analog PC signal (Analog PC-2).

(4) HDMI IN terminal (HDMI IN) (P51)

Receives the digital content image signal (HDMI).
Carries both video and audio signals across a single cable.

(5) Service port (CONTROL)

This terminal is used by servicing technicians. It is not used during ordinary use.

(6) Terminal for wired remote control (REMOTE) (P30)

This terminal is used to connect the remote control using a cable.

(7) AUDIO IN terminal (AUDIO IN) (P47, P50, P53)

Receives the audio signal input for 2 kinds of image input except HDMI IN.
The internal speaker outputs the audio for the selected image signal.

(8) AUDIO OUT terminal (AUDIO OUT) (P51, P55)

Outputs the audio to external AV equipment. This outputs the audio signal that corresponds to the projected image signal.

MULTIMEDIA PROJECTOR

WUX5000

WUX4000

WX6000

SX6000

User's Manual (Operation)



Projecting an Image

Table of Contents

Safety Instructions

Before Use

Projecting an Image

Useful Functions Available
During a Presentation

Setting Functions from Menus

Installation

Connecting to a Network

Maintenance

Appendix

Index

User's Manual

Installation Manual

Appendix

Steps for Connecting the Projector and Projecting an Image



Installation work should be performed by a qualified technician.
Contact the Canon Customer Support Center for further information.

Connecting the Projector to Equipment (P162)



Starting Projection (P56)



Do you want to project an image from a notebook computer?

No

Yes

For a notebook computer, turn on the monitor output (P58) and then proceed.

Selecting an Input Signal (P59)

Is the image projected properly?

No

Yes

Projection is complete.

Adjusting the Image (P61)

Make the following adjustments.

- Setting the Display Resolution of the Computer (P61)
- Selecting an Aspect Ratio of Projected Image (Screen aspect) and a Screen Mode (Aspect) (P63, P69)
- Adjusting Misaligned Images or Flickering of the Screen Using the Auto PC (P62)
- Adjusting the Image Size (P71)
- Adjusting the Focus (P73)
- Adjusting the Image Position (Lens shift) (P74)
- Adjusting Keystone Distortion (P76)

Making Fine Adjustments

- Selecting an Image Mode (P78)

Connecting the Projector

Connecting the Projector to a Computer

Connect the projector to the computer.

A digital connection (P50) is recommended when projecting an image in high quality. When using a computer with an HDMI output terminal, a digital connection (P51) can be made using an HDMI cable.



Before connecting the cables, turn off both the projector and computer.

Caution

■ Connecting to RGB Monitor Output Terminal (Analog Connection)

Connecting with a VGA cable (Input signal type: [Analog PC] (WUX5000 / WUX4000), [Analog PC-1] (WX6000 / SX6000) P59)

WUX5000 / WUX4000

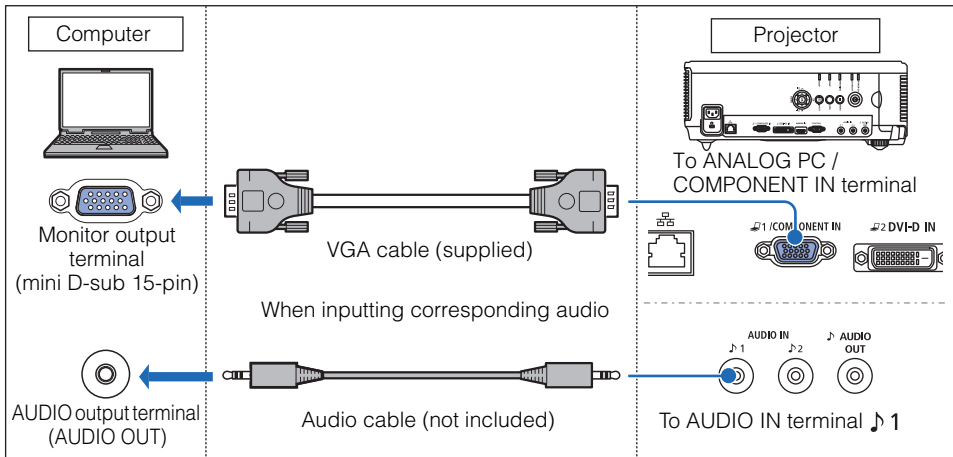

Connecting the Projector

WX6000 / SX6000

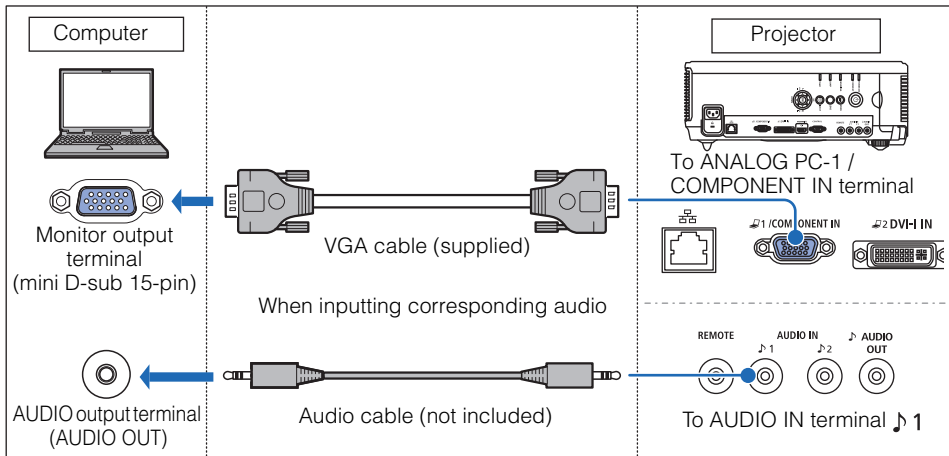

Connecting with VGA-DVI cable (Input signal type: [Analog PC-2] P59)

WX6000 / SX6000

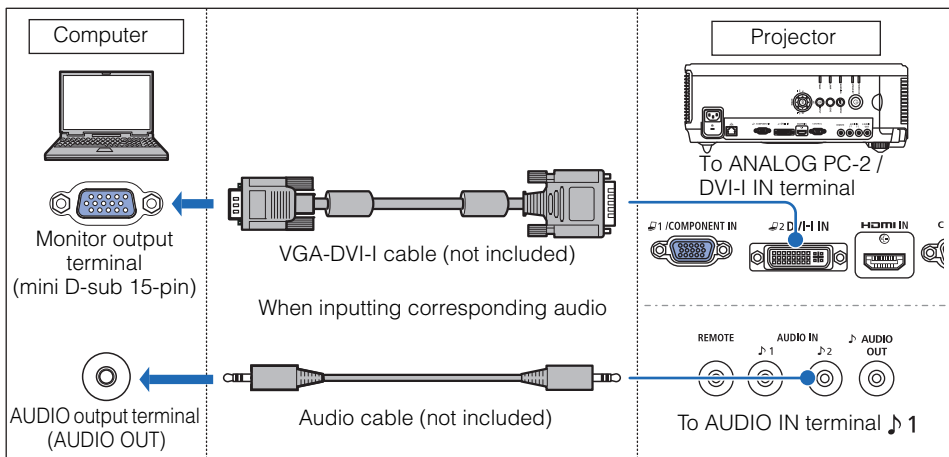

- Use a VGA cable in which all pins are connected. If the cable is a type in which all pins are not connected, the image may not be correctly displayed.
- Use an audio cable without a built-in resistor. Using an audio cable with a built-in resistor will reduce the audio volume.
- The AUDIO IN terminal can be changed in the Audio in terminal select screen (P139). (WX6000 / SX6000)

Connecting with a BNC cable (Input signal type: [Analog PC] (WUX5000 / WUX4000), [Analog PC-1] (WX6000 / SX6000) [P59](#))

WUX5000 / WUX4000

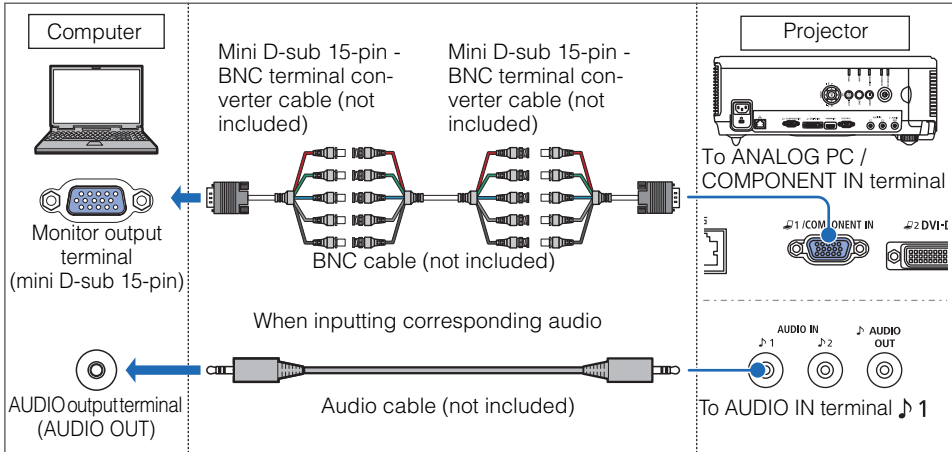

WX6000 / SX6000

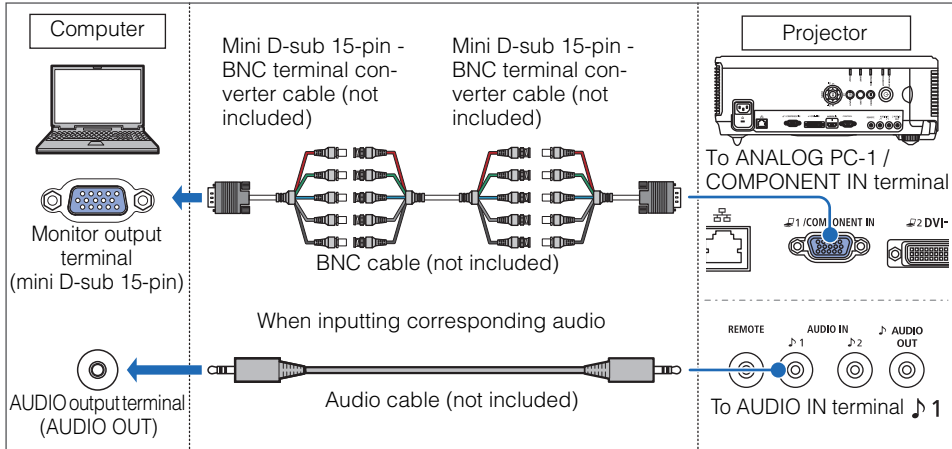

- A signal with a dot clock higher than 162 MHz cannot be projected.
- Use an audio cable without a built-in resistor. Using an audio cable with a built-in resistor will reduce the audio volume.
- The AUDIO IN terminal can be changed in the Audio in terminal select screen ([P139](#)). (WX6000 / SX6000)

Connecting the Projector

■ Connecting to DVI Monitor Output Terminal (Digital Connection)

Connecting with a DVI cable (Input signal type: [DVI-D] (Digital PC) – P59)

WUX5000 / WUX4000

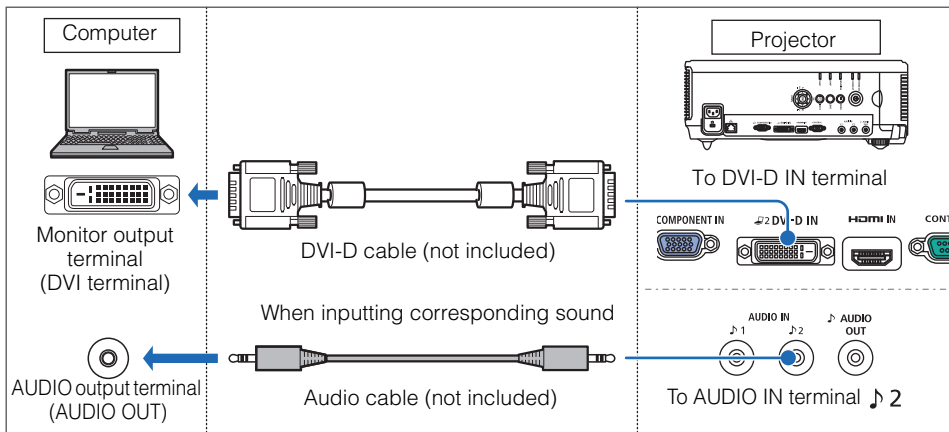

WX6000 / SX6000

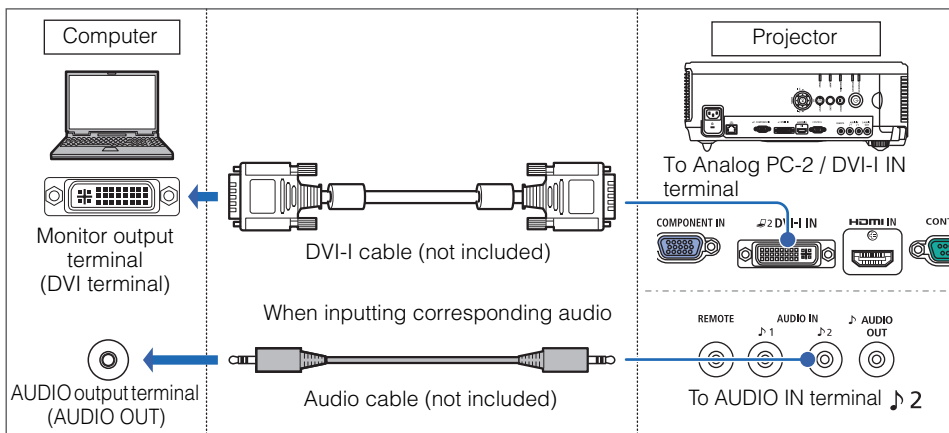

- Use an audio cable without a built-in resistor. Using an audio cable with a built-in resistor will reduce the audio volume.
- The AUDIO IN terminal can be changed in the Audio in terminal select screen (P139). (WX6000 / SX6000)

■ Connecting with a HDMI Cable (Input signal type: [HDMI] – P59)

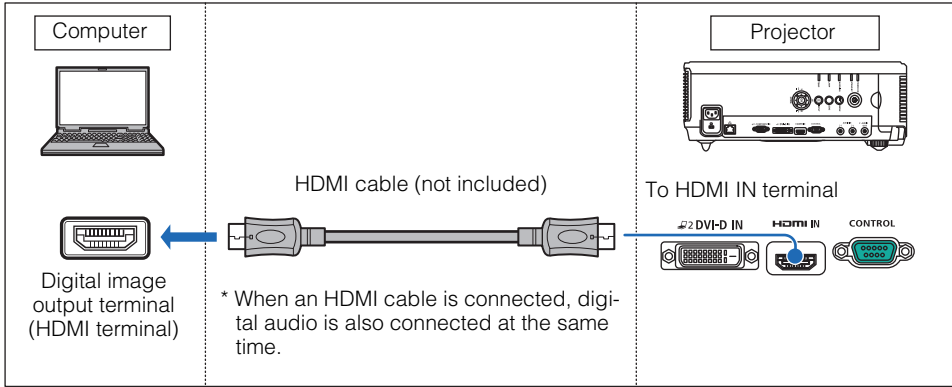

■ Outputting Audio to Speakers

It is possible to output audio from the projected images to amplified speakers.

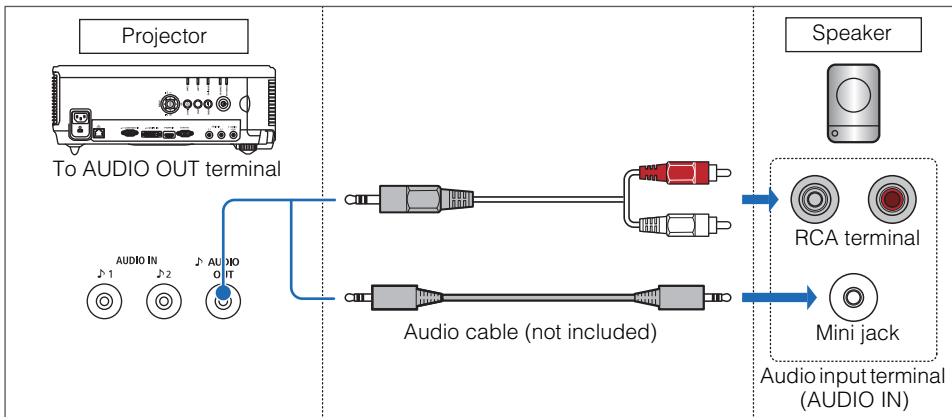

! Use an audio cable without a built-in resistor. Using an audio cable with a built-in resistor will reduce the audio volume.

Connecting the Projector

Connecting to AV Equipment

Connect the projector and AV equipment.

The description provided here is one example. For more detailed information, refer to the manual for the connected AV equipment.



Before connecting the cables, turn off both the projector and AV equipment.

Caution

■ Connecting to Digital Video Output Terminal (Digital Connection)

Connecting with a HDMI cable (Input signal type: [HDMI] – P59)

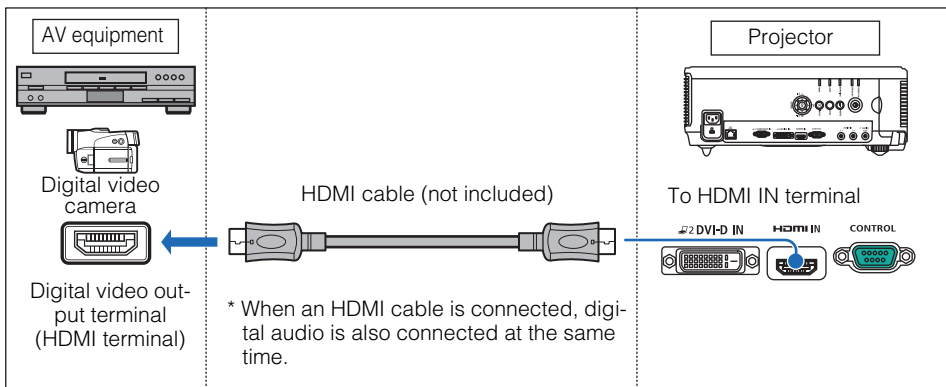

■ Connecting to Analog Video Output Terminal (Analog Connection)

Connecting with a component cable (Input signal type: [Component] – P59)

A component video signal from the AV equipment can be inputted into the projector by connecting the component cable to the COMPONENT IN terminal of the projector.

Use a commercially available component cable (not included) that fits the terminal type of the AV equipment to create a relay connection.

WUX5000 / WUX4000

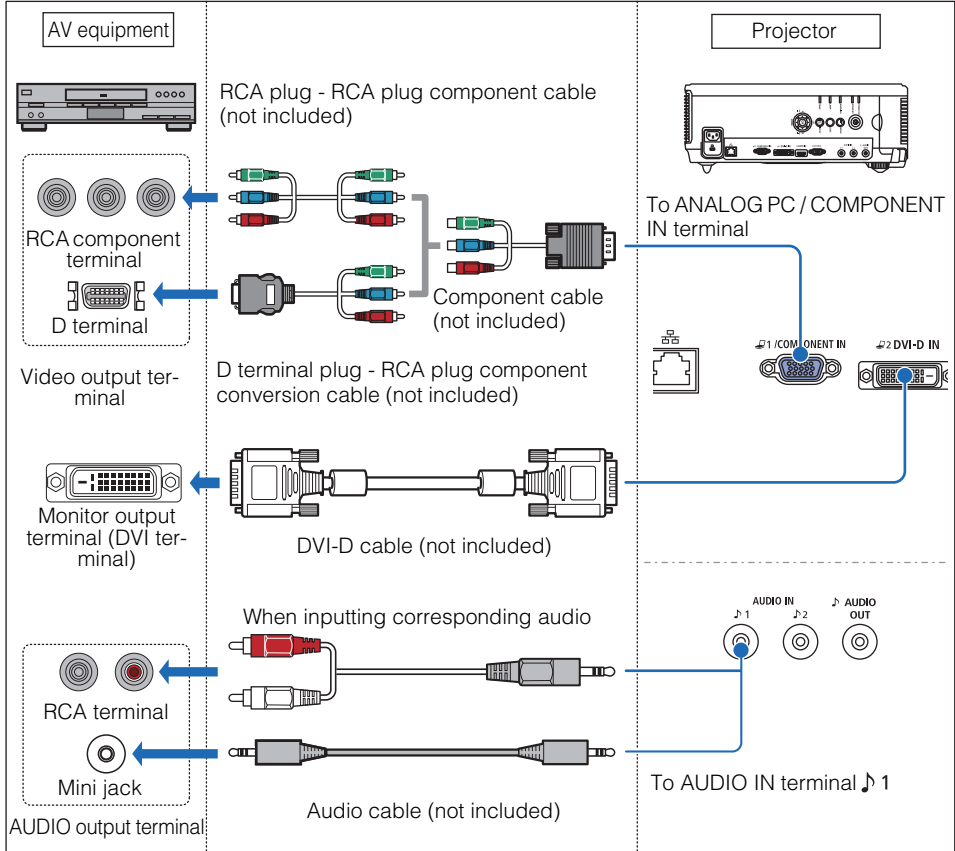

Connecting the Projector

WX6000 / SX6000

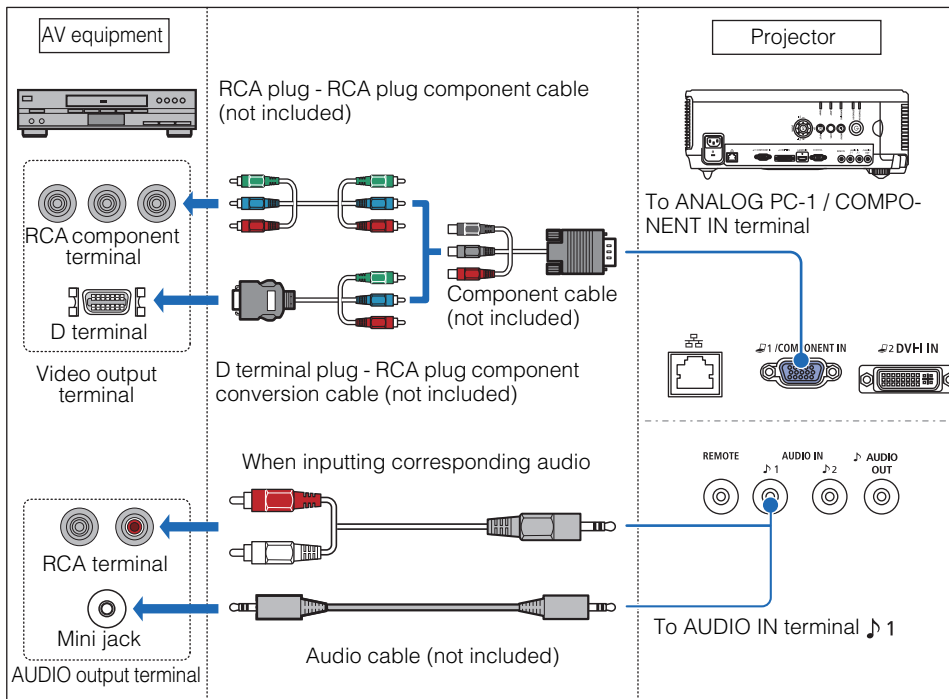

- Use an audio cable without a built-in resistor. Using an audio cable with a built-in resistor will reduce the audio volume.
- The AUDIO IN terminal can be changed in the Audio in terminal select screen (P139). (WX6000 / SX6000)

■ Outputting Audio to Speakers

It is possible to output audio from the projected images to AV equipment or amplified speakers.

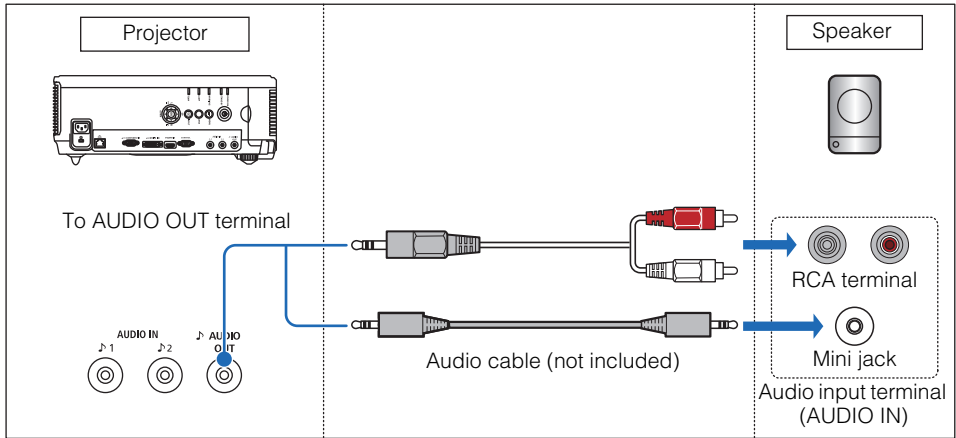

Use an audio cable without a built-in resistor. Using an audio cable with a built-in resistor will reduce the audio volume.

Starting Projection

- 1 Check the connection between the projector and the computer or AV equipment. (P52 – P55)
- 2 Connect the power cord and make sure that the [STAND BY] indicator is lit (red).

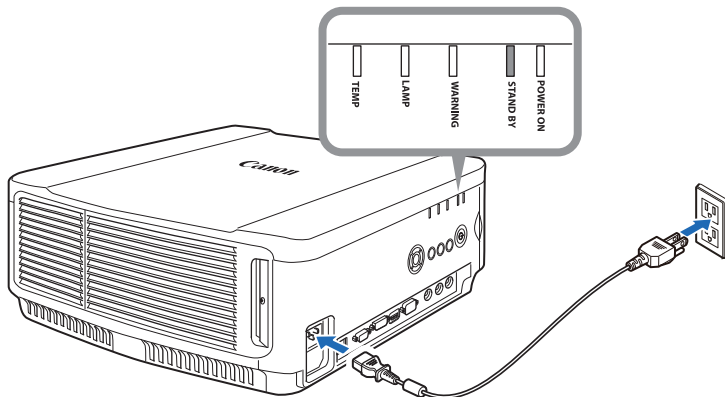

Warning

Connect the ground terminal on the power plug to ground. Not doing so could result in an electric shock. Also the computer may suffer electromagnetic interference or be subject to poor TV and radio reception.



- Fully insert the power cord plug into the socket.
- After turning off the projector, wait at least 5 minutes before turning it on again. It may shorten the lamp life if you turn on the projector immediately after turning it off.
- Unplug the power cord when not in use.

- 3 Press the POWER button.

The [POWER] indicator flashes green, and then stops flashing and remains lit.

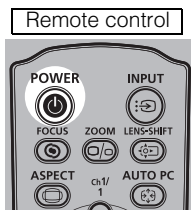

WUX5000 / WUX4000

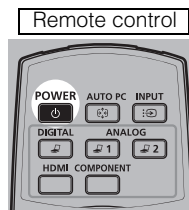
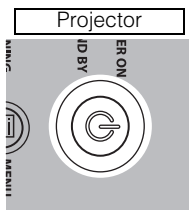

WX6000 / SX6000

The countdown window is displayed for approximately 20 seconds, and then the projection is started. Press the **OK** or **EXIT** button (WX6000 / SX6000) to make the countdown window disappear.

4 Turn on the computer or AV equipment power.

Changing Operations When Projector is Turned On

You can change operations when the projector is turned on as follows.

- You can turn on the projector by connecting the power cord, without pressing the **POWER** button. (P121)
- You can change the countdown window. (P106)
- You can skip the countdown window. (P56)

Using the Power Saving Mode (Power Management)

When you enable the power management mode, the lamp is automatically turned off if the projector receives no signal input for a certain period of time. (P120)

■ When the Language Selection Screen Appears

A window appears when the projector is turned on for the first time. You can select a language to be used by the projector for displaying menus and messages in the window. Select the desired language with the pointer buttons and press the **OK** button.

You can change the language from the menu at a later time. (P125)

If the language selection screen is out of focus, press the **FOCUS** button to perform focus adjustment. (P73)

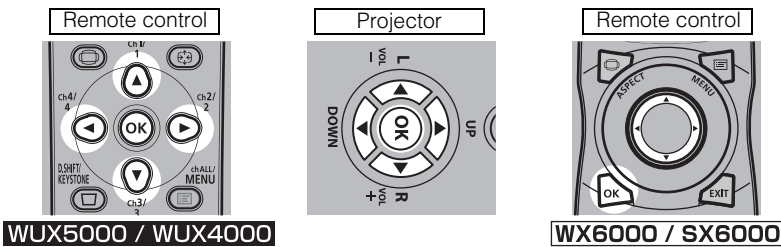

Language		
▶ English	Русский	Čeština
Deutsch	Nederlands	Dansk
Français	Suomi	انٹلزي
Italiano	Norsk	中文简体
Español	Türkçe	中文繁體
Português	Polski	한국어
Svenska	Magyar	日本語

An item highlighted in orange will be selected.

Starting Projection

■ When the Password Input Screen Appears

If you have set a password, the Password input screen appears. Enter your password. (P128)

■ When “No signal” Appears

With a notebook computer, the user must turn on the external monitor output. (P58)

Press the INPUT button to select the input signal. (P60)

■ When Notebook Computer Screen Does Not Appear

Set your notebook computer to output signals to an external monitor. For more details, refer to “Changing Notebook Computer Screen Output” below.

■ Adjusting Image

- Set the display resolution of the computer to the highest resolution or the resolution closest to that setting. (P61)
- Use the auto PC function to adjust shift in computer image or the flickering of the screen. (P62)
- Use the ZOOM button to adjust the size of the projected image. (P71)
- Use the FOCUS button to correct the focus adjustment if necessary. (P73)
- Use the D.SHIFT/KEystone button (WUX5000 / WUX4000) or KEystone button (WX6000 / SX6000) to adjust keystone correction if necessary. (P76)
- Select the aspect ratio of the projected image (screen aspect) or a screen mode (aspect) according to the aspect ratio of the screen, type of input image signal etc. (P63 - P70)
- Select an image mode depending on the projected image. (P78)

Changing Notebook Computer Screen Output

With a notebook computer, the user must turn on the external monitor output on the computer side.

This operation is not required for a desktop computer.

■ Turning on External Monitor Output

You can turn on the external monitor output via keyboard operation.

To turn on the external monitor output with most computers, press the function key ([F1] to [F12]) which is marked with the external monitor icon while holding down the [Fn] key.

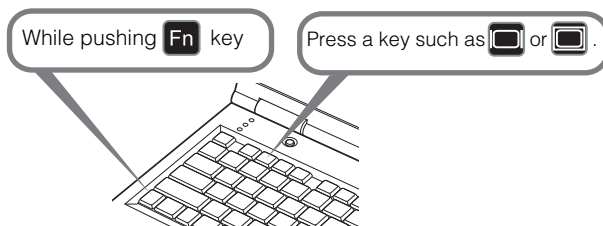

- The function key you use and the method used to turn on the external monitor output vary depending on the model. For details, see the manual for your notebook computer.
- With Windows 7, you can turn on image output by holding down the Windows logo key and pressing the [P] key.







Selecting an Input Signal (INPUT)

Select the input signal in the [Input] menu when you want to project a digital PC or AV equipment signal, or to switch between inputs when multiple computers or multiple sets of AV equipment are connected.

Skip this step if you have not changed the input signal since the last projection.

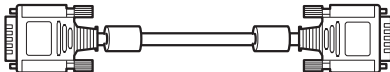
Types of Input Signals

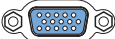
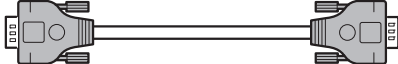
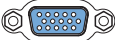
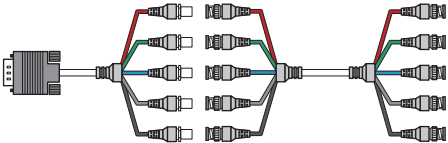
The table below shows the relationship among input signals supported by the projector, input terminals and connection cables.

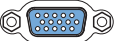
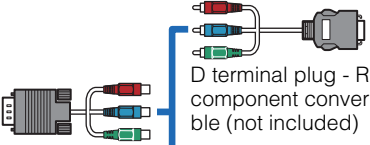
Input signal	Supported projectors	Input terminal	Types of connection cables
HDMI	WUX5000 WUX4000 WX6000 SX6000	HDMI IN 	HDMI cable (not included) 
Digital PC	WUX5000 WUX4000	2 DVI-D IN 	DVI cable (not included) 
	WX6000 SX6000	2 DVI-I IN 	
Analog PC Analog PC-1	WUX5000 WUX4000 WX6000 SX6000	1 / COMPONENT IN 	VGA cable (supplied) 
	WUX5000 WUX4000 WX6000 SX6000	1 / COMPONENT IN 	BNC cable (not included)  Mini D-sub 15-pin - BNC terminal converter cable (not included)
Analog PC-2	WX6000 SX6000	2 DVI-I IN 	VGA-DVI cable (not included) 
Component	WUX5000 WUX4000 WX6000 SX6000	1 / COMPONENT IN 	Component cable (not included)  D terminal plug - RCA plug component conversion cable (not included) RCA plug - RCA plug component cable (not included)

Selecting an Input Signal (INPUT)

■ Selecting an Input Signal

1 Press the INPUT button to display the window shown below.

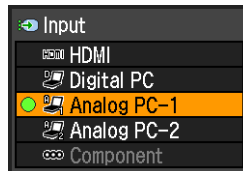
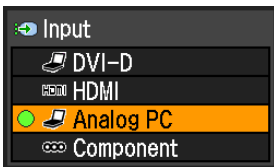
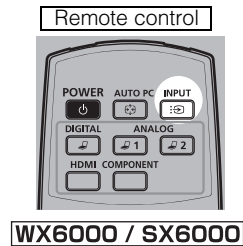
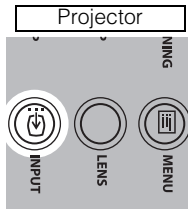
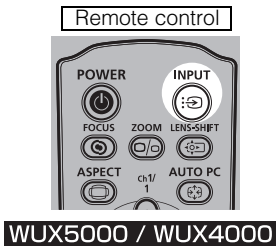

The currently active input signal is marked with a circle and highlighted in orange. An input signal that is ready for projection is displayed in white. When no signal is received, it is displayed in gray. However [HDMI] and [DVI-D] (WUX5000 / WUX4000) (Digital PC), or [Digital PC] (WX6000 / SX6000) may be displayed in gray even if they are ready for projection.

2 You can switch the available input signal types by pressing the INPUT button.

- You can select the target input signal with [▲] / [▼].
- Only the input signals displayed in white can be selected.

3 Press the OK button to confirm the input signal type.

Change the input signal with the input signal buttons. (WX6000 / SX6000)

For WX6000 / SX6000, you can also switch to the input signal you want by pressing the button that corresponds to that signal.

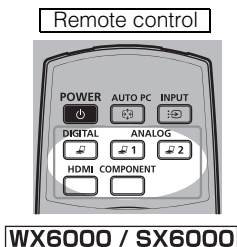

Adjusting the Image

Setting the Display Resolution of the Computer

Based on the maximum resolution of the projector, set the display resolution of the computer to the resolution closest to the output signal resolution of the projector. (P218)

Maximum resolution

WUX5000 / WUX4000: 1920 X 1200 dots

SX6000: 1400 X 1050 dots

WX6000: 1440 X 900 dots

■ Windows 7

- 1 Open the [Control Panel] from the start menu, then select [Appearance and Personalization] - [Adjust screen resolution] in the [Control Panel Home].
- 2 Click the [Resolution] tab, and move the slider to select or the resolution closest to the maximum output signal resolution of the computer.
- 3 Click the OK button.

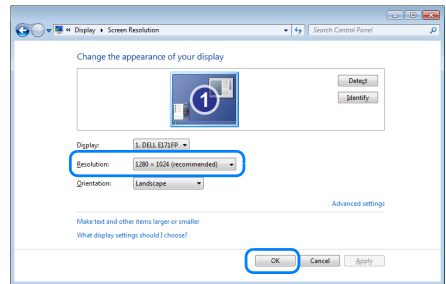

■ Windows Vista

- 1 Open the [Control Panel] from the start menu, then select [Appearance and Personalization] - [Adjust screen resolution] in the [Control Panel Home].
- 2 Select the resolution closest to the maximum output signal resolution of the computer from the [Resolution] list.
- 3 Click the OK button.

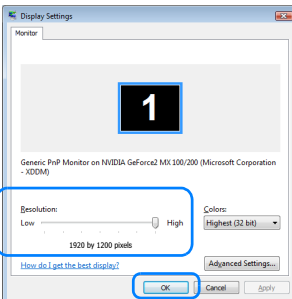

■ Windows XP

- 1 Right-click on the desktop background and select [Properties] to open the [Display Properties].
- 2 Click the [Settings] tab, and under [Screen Resolution], select the resolution closest to the maximum output signal resolution of the computer.
- 3 Click the OK button.

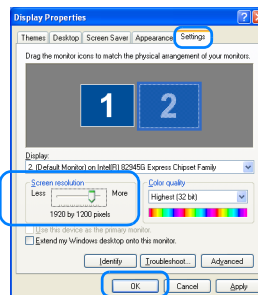

Adjusting the Image

■ Mac OS X

- 1 Open the Apple Menu and select [System Preferences].
- 2 In the [System Preferences] window, click the [Displays] icon to display the Display window.
- 3 Select the [Display] tab and select the resolution closest to the maximum output signal resolution of the computer from the [Resolutions] list.
- 4 Close the [System Preferences] window.

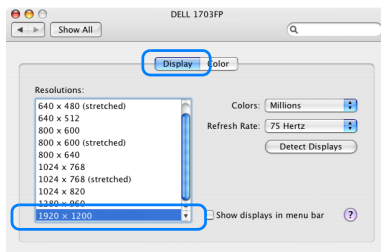

AUTO PC

If the image display is shifted or there is flickering of the screen when [Analog PC] (WUX5000 / WUX4000) or [Analog PC-1] [Analog PC-2] (WX6000 / SX6000) is selected, press the **AUTO PC** button to adjust the projector to the optimal condition.

The adjustment results will be stored. If the projector is used again with the same computer, when the input signal is selected the image will be projected automatically under the same conditions that were previously adjusted.

■ Performing the Auto PC Function

Press the **AUTO PC** button to perform projector adjustment.

Remote control

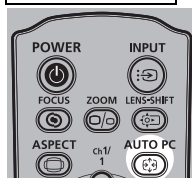

WUX5000 / WUX4000

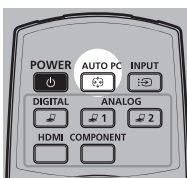

WX6000 / SX6000



If the projected image was not properly adjusted with the [AUTO PC] function, perform the following steps.

- From [Input signal select], select an input signal type based on the resolution of the computer. (P94)
- If the adjustment is still insufficient, from [Input signal settings] select [Total dots], [Tracking], [Horizontal position], [Vertical position], [Horizontal pixels] and [Vertical pixels] to make adjustments. (P95 - P98)
- For the signal types supported by the projector, see the table on [page 218](#).

Selecting Screen Aspect and Aspect

Select an optimum aspect ratio of the projected image (screen aspect) or an optimum screen mode (aspect) according to the aspect ratio of the screen, type of input image signal and so on for the projection to make best use of the screen size.

[Screen aspect] Select the same screen aspect ratio as the screen you are using.
[Aspect] In general, select [Auto].

You may need to change the setting depending on the resolution of the computer or other AV equipment connected. If the image is not projected with the desired aspect ratio, refer to [page 207](#).

■ Selecting Screen Aspect

Select the correct aspect ratio for the screen which is used.

Perform the following steps to select the aspect ratio of the projected image.

- 1 Press the MENU button to display a menu window.

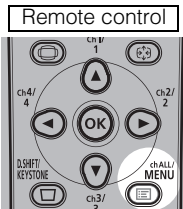

WUX5000 / WUX4000

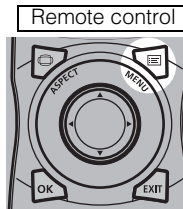
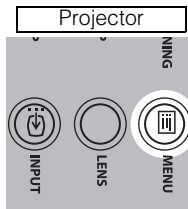

WX6000 / SX6000

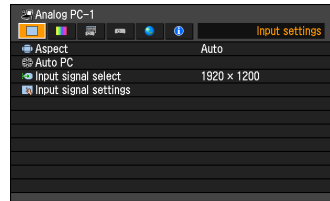
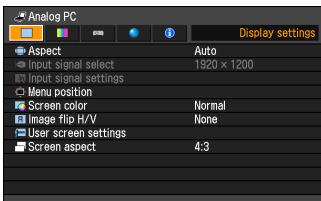

Adjusting the Image

2 Use the [◀] / [▶] buttons to select the [Display settings] tab (WUX5000 / WUX4000) or [Install settings] (WX6000 / SX6000).

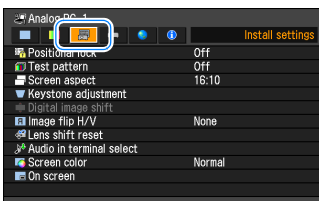
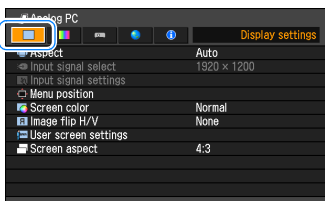
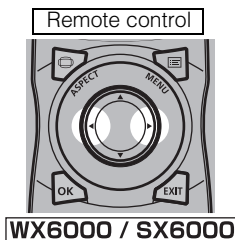
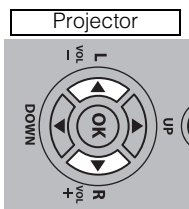
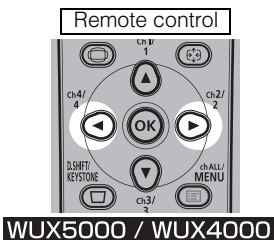

3 Select [Screen aspect] with the [▲] / [▼], and then press the OK button.

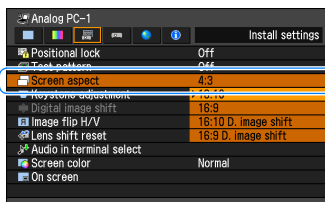
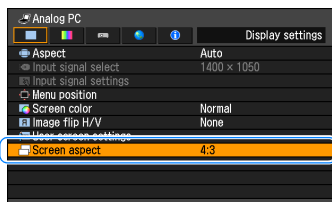
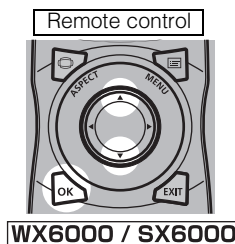
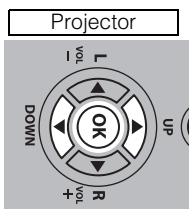
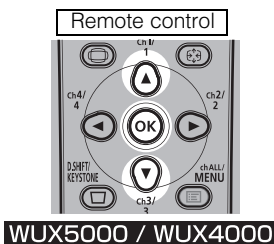

4 Use the [▲] / [▼] buttons to select the desired contents.

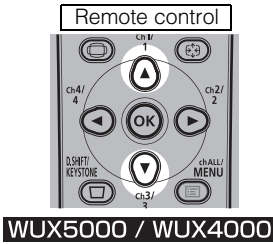

WUX5000 / WUX4000

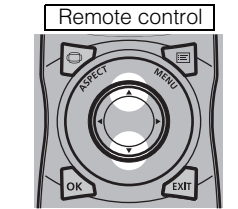
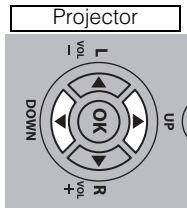
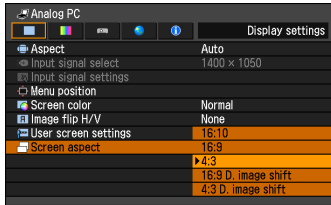

WX6000 / SX6000

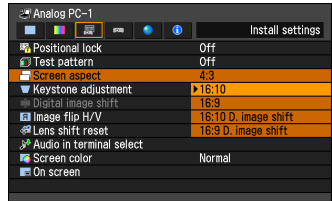

Screen aspect compatibility for each model of projector is as follows.

	WUX5000	WUX4000	WX6000	SX6000
16:10	○	○	○	○
16:9	○	○	○	○
4:3	○	○	○	○
16:10 D. image shift	—	—	○	—
16:9 D. image shift	○	○	○	○
4:3 D. image shift	○	○	—	○

○ : Compatible — : Not compatible

Adjusting the Image

16:10

Select this when you use a screen with aspect ratio of 16:10. Also, select this when you project an image on a wall. You can correct keystone distortion with this mode. (P76)



16:10 screen

16:9

Select this when you use a screen with aspect ratio of 16:9. You can correct keystone distortion with this mode. (P76)



16:9 screen

4:3

Select this when you use a screen with aspect ratio of 4:3. You can correct keystone distortion with this mode. (P76)



4:3 screen

16:10 D. image shift (SX6000)

Select when the screen aspect ratio is 16:10. Keystone correction cannot be performed in this mode. However when projecting level, it is possible to shift the image up or down.

For details about how to shift the image, refer to [page 67](#).

16:9 D. image shift

Select this when you use a screen with aspect ratio of 16:9. You cannot correct keystone distortion in this mode, but you can move the image up or down with images being projected horizontally.

For the details on how to move the image, refer to [page 67](#).

4:3 D. image shift (WUX5000 / WUX4000 / WX6000)

Select this when you use a screen with aspect ratio of 4:3.

You cannot perform the keystone adjustment in this mode; however, you can move the image to the left or right while projecting the image horizontally.

For the details on how to move the image, refer to [page 68](#).

5 Press the OK button to confirm your setting and then press the MENU button.

Moving Image with 16:9 D. Image Shift / 16:10 D. Image Shift (SX6000)

16:10 D. image shift cannot be used for the WUX5000, WUX4000 and WX6000.

- For the WUX5000 / WUX4000, when the screen aspect is [16:9 D. image shift], if the D.SHIFT/KEYSTONE button is pressed, the screen below on the right is displayed.

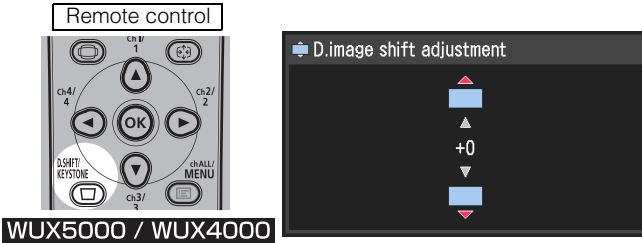

For the WX6000 / SX6000, when the screen aspect is [16:9 D. image shift], and for the SX6000, when the screen aspect is set to [16:10 D. image shift], press the MENU button, select the [Installation settings] tab with the [◀] and [▶] buttons, and then select [Digital image shift] with the [▼] and [▲] buttons. (P108)

- Use the [▼] / [▲] buttons to move the image.

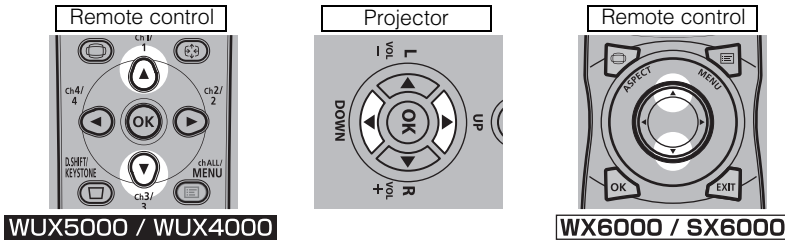

Screen

[▲] button

Moves image up

[▼] button

Moves image down



- When the image fits the screen, press the OK button.

Adjusting the Image

Moving Image with 4:3 D. Image Shift (WUX5000 / WUX4000 / WX6000)

4:3 D image shift cannot be used for SX6000.

- 1 For the WUX5000 / WUX4000, when the screen aspect is [4:3 D. image shift], if the D.SHIFT/KEYSTONE button is pressed, the screen below on the right is displayed.

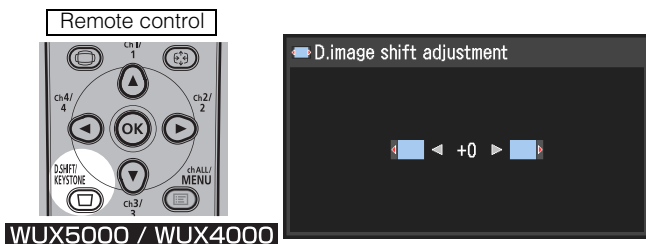

For the WX6000, when the screen aspect is set to [4:3 D. image shift], press the MENU button, select the [Installation settings] tab with the [◀] and [▶] buttons, and then select [Digital image shift] with the [▼] and [▲] buttons. (P108)

- 2 Use [◀ / ▶] to move the image.

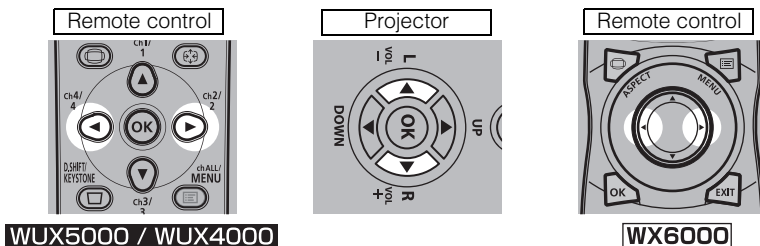

Screen

[◀] button

Moves the image left



[▶] button

Moves the image right



- 3 When the image fits the screen, press the OK button.

Resetting the Image Shift

Perform the following steps to reset the image shift adjustment.

Press the **D.SHIFT/KEYSTONE** button (WUX5000 / WUX4000), twice to display the [D. image shift reset] window.

Then, select [OK] with the [◀] button and press the **OK** button.

■ Selecting Aspect Ratio

Select [Aspect] based on the input signal type, aspect ratio of the screen and resolution. For more details about aspect ratios, refer to [page 207](#).

Types of Aspect Ratios

Auto

The image is projected at the aspect ratio of the input signal. Select this mode for normal image projection.

Full (WUX5000 / WUX4000)

The image is projected using an input signal aspect ratio of 16:10.

Select this to project computer screen images having an aspect ratio of 16:10 (WUXGA, WSXGA+, WXGA+ and WXGA (1280 x 800)) fully on the screen.

 This can only be selected when the screen aspect is 16:10.

16:10 (WX6000 / SX6000)

The image is projected using an input signal aspect ratio of 16:10.

Select this if an image of 16:10 aspect ratio cannot be correctly projected in [Auto] mode when using video software.

16:9

The image is projected using an input signal aspect ratio of 16:9. Select this if an image of 16:9 aspect ratio cannot be correctly projected in [Auto] mode.

4:3

The image is projected using an input signal aspect ratio of 4:3. Select this if an image of 4:3 aspect ratio cannot be correctly projected in [Auto] mode.

Zoom

This cuts the upper/lower or left/right part of the image according to the screen aspect and zooms in or out of the center of the image. Select this if a letter box is displayed (black lines at the top/bottom of the screen) when using video software.

 There may be some cases when this cannot be selected, depending on the input signal and/or resolution.

True size

The image is projected with the original resolution of the input signal. Select this to clearly project a computer screen image which has a resolution of WUXGA or lower.

 There may be some cases when this cannot be selected, depending on the input signal and/or resolution.

Adjusting the Image

How to Select an Aspect Ratio

Press the **ASPECT** button on the remote control and select an appropriate aspect ratio. Press the **ASPECT** button to change the aspect ratio type.

For more details about aspect ratios, refer to [page 207](#).

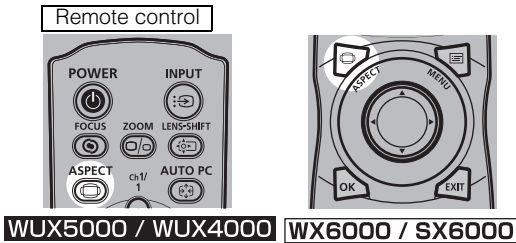

Example:

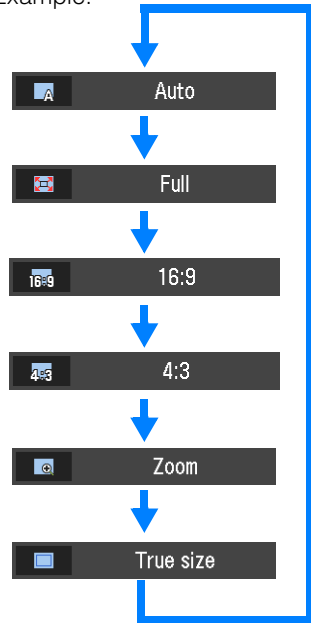

You can also select any aspect ratio from [Aspect] in the menu. (P93)



Some aspect ratios may not appear depending on the type of input signal.

Adjusting the Image Size

The size of the projected image can be adjusted by pressing the **ZOOM** button on the remote control or the **LENS** button on the projector. Change the projector installation position if your desired image is too large or too small to adjust it with the zoom function. (P156)

- 1 Press either the **ZOOM** button on the remote control or the **LENS** button on the projector twice in order to display the window shown below.

Remote control

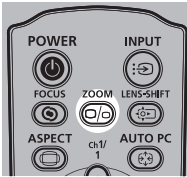

WUX5000 / WUX4000

Projector

Push twice

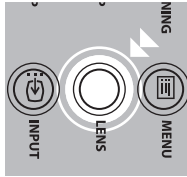

Remote control

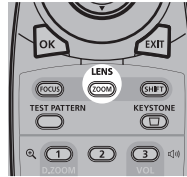

WX6000 / SX6000

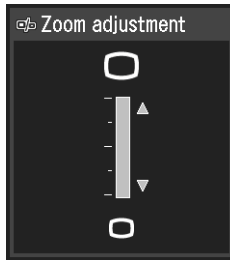

Adjusting the Image

2 Press the pointer buttons to adjust the image size.

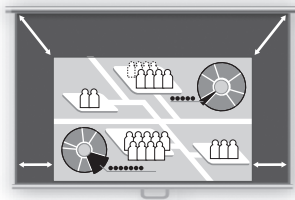
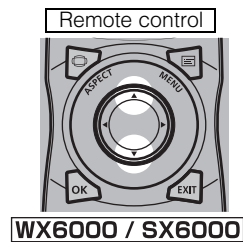
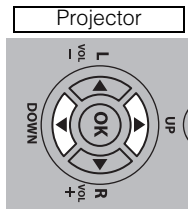
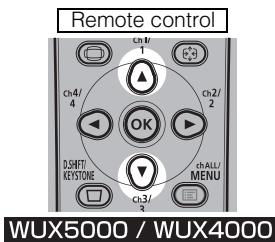

Use the [▲] button on the remote control, or the UP button on the projector to increase the image size.

Use the [▼] button on the remote control, or the DOWN button on the projector to decrease the image size.

3 When the desired image size is selected, press the OK button or the ZOOM button.



When the Short Fixed Lens (RS-IL03WF) is attached, zoom adjustment cannot be performed.

Adjusting the Focus

To adjust the focus, press the **FOCUS** button on the remote control or the **LENS** button on the projector.

For the projection distances of the lens unit, refer to [page 156](#).

- 1 Press either the **FOCUS** button on the remote control or the **LENS** button on the projector in order to display the window shown below.

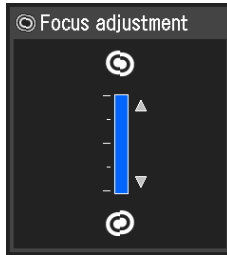
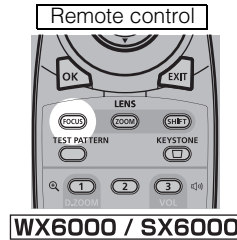
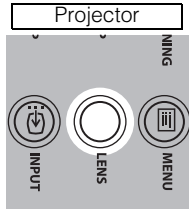
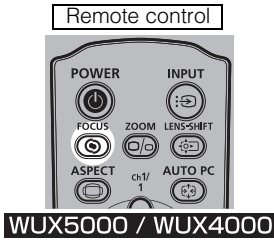

- 2 Press the pointer buttons to adjust the focus.

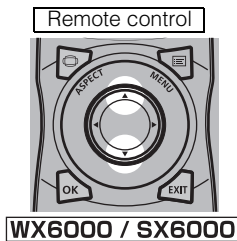
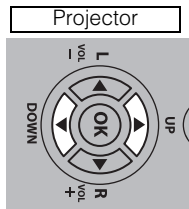
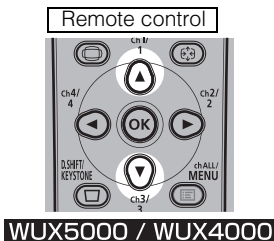

Use the **[▲]** button on the remote control, or the **UP** button on the projector to adjust the focus position.

Use the **[▼]** button on the remote control, or the **DOWN** button on the projector to perform fine adjustment.

- 3 When the focus is adjusted optimally, press the **OK** button or the **FOCUS** button.

Adjusting the Image Position

To adjust the screen position up, down, left, or right, press the **LENS-SHIFT** button (WUX5000 / WUX4000) or **SHIFT** button (WX6000 / SX6000) on the remote control, or the **LENS** button on the projector. This function is referred to as “lens shift”. It can change the projected screen to the most suitable position by moving the position of the lens up/down/left/right. (P160)

- ◆ The available range for lens shift (percentage of movement relative to the screen size) varies depending on the lens unit which is used. (P161)
- There are areas where each lens is unable to move. With the Short Fixed Lens (RS-IL03WF), the areas are at the four corners and for the other lenses, the areas are at the top left and bottom right. (P161)

1 Press either the **LENS-SHIFT** button (WUX5000 / WUX4000) or the **SHIFT** button (WX6000 / SX6000) on the remote control, or the **LENS** button on the projector 3 times in order to display the window shown below.

* If the Short Fixed Focus Lens (RS-IL03WF) is attached, when the **LENS** button on the projector is pressed twice, the window below will be displayed.

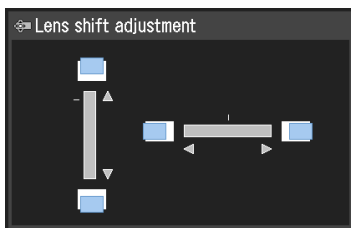
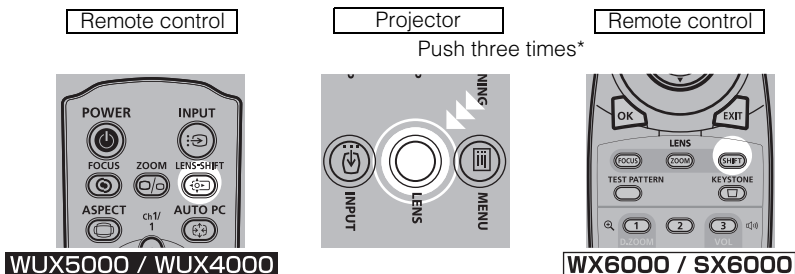

2 Press the pointer buttons to adjust.

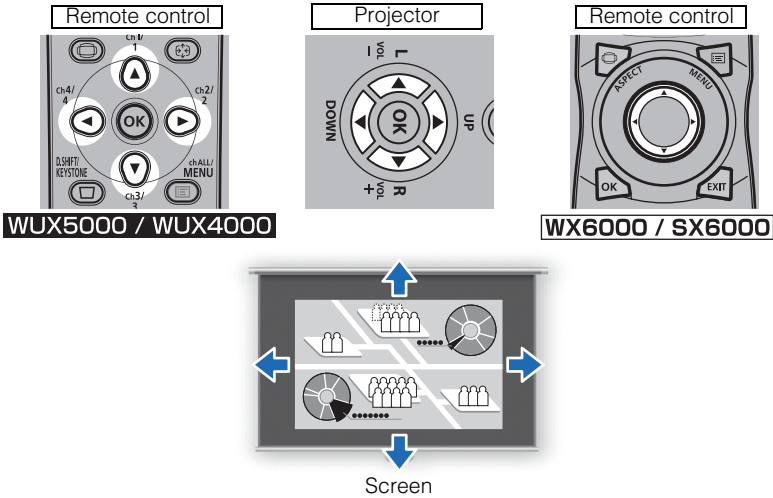

3 When the desired position is reached, press the OK button.

Resetting the Position

The lens position after movement with the lens shift function is not returned when the power is turned off. To return it to its original position, perform reset.

During screen position adjustment, press and hold the **LENS-SHIFT** button (WUX5000 / WUX4000) or **SHIFT** button (WX6000 / SX6000) on the remote control, or the **LENS** button on the projector to display the [Lens shift Reset] window.

The selections for the lens currently used are displayed. Use the pointer buttons to select one of them, then press the **OK** button.

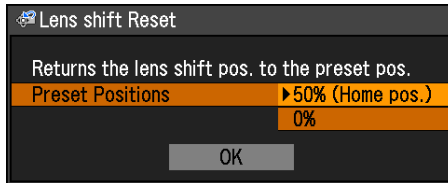

Lens unit type	Available items
Standard Zoom Lens RS-IL01ST	
Long Zoom Lens RS-IL02LZ	50% (Home position) : Up 50%, left / right 0% 0% : Up / down / left / right 0%
Ultra Long Zoom Lens RS-IL04UL	
Short Fixed Lens RS-IL03WF	0% (Home position) : Up / down / left / right 0%

Adjusting Keystone Distortion

The **D.SHIFT/KEYSTONE** button (WUX5000 / WUX4000) or **KEYSTONE** button (WX6000 / SX6000) can be used to correct keystone distortion.

- ◆ Keystone can be adjusted within the range of ± 20 degrees. If the keystone distortion is too large to adjust, move the projector installation position so that it is completely straight.
- The result of keystone adjustment is stored in memory. If you place the projector in the same position, the keystone adjustment is not necessary.
- Signals are processed digitally when keystone distortion is corrected. The image may look different from the original one. In addition, the aspect ratio of the image may change.
- Perform keystone distortion correction with the lens shift position in the home position. Correction will not be performed correctly if the position is not the home position.

1 Press the **D.SHIFT/KEYSTONE** button (WUX5000 / WUX4000) or **KEYSTONE** button (WX6000 / SX6000) to display the window in the center illustration below.

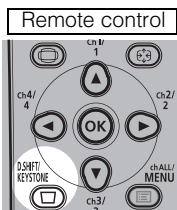

WUX5000 / WUX4000

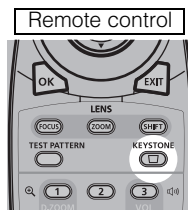
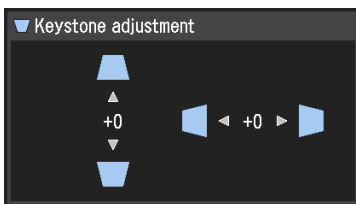

WX6000 / SX6000

2 Press the pointer buttons to adjust.

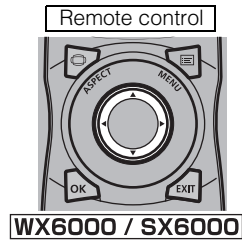
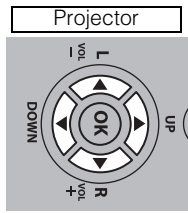
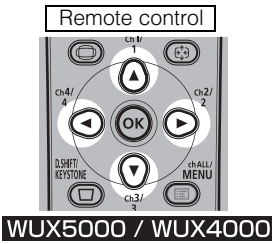

[▲] button

Reduces the dimensions of the upper edge

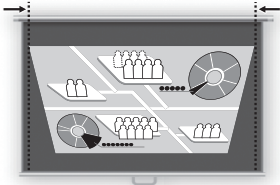

[▼] button

Reduces the dimensions of the lower edge

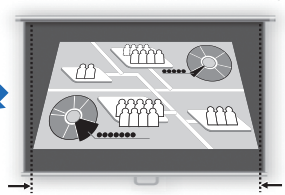

[◀] button

Reduces the dimension of the left edge

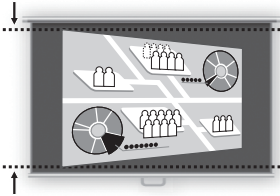

[▶] button

Reduces the dimension of the right edge

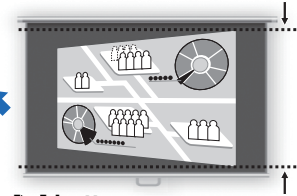

Screen

3 When keystone distortion has been corrected, press the OK button.

■ Resetting the Keystone Adjustment

Perform the following steps to reset the keystone adjustment.

Press the **D.SHIFT/KEYSTONE** button (WUX5000 / WUX4000) or **KEYSTONE** button (WX6000 / SX6000) twice to display the [Keystone reset] window.

Then, select [OK] with the [◀] button, and press the OK button.

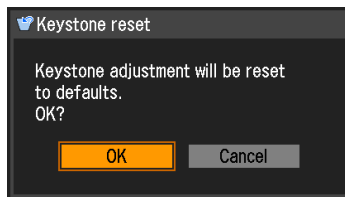

Selecting an Image Mode

You can select an image mode to suit the projected image.

In each image mode, you can further adjust the brightness, contrast, sharpness, gamma, color adjustment, advanced adjustment, and lamp mode (WUX4000). (P109)

■ Image Modes

The image modes which can be selected vary somewhat depending on the selected input signal.

Image Mode	Compatible input signals		Explanation
	Digital PC Analog PC (WUX5000 / WUX4000) Analog PC-1, 2 (WX6000 / SX6000) HDMI (when [HDMI In] is [Computer])	Component HDMI (when [HDMI In] is [Auto])	
Standard	○	○	Suitable for projecting a computer screen or watching media played with video software in a brightish room. This image mode emphasizes white tones.
Presentation	○	—	Suitable for viewing text-based images in a brightish room.
Dynamic	—	○	Suitable for watching media played with video software in a brightish room.
VividPhoto	○	—	Suitable for viewing images with vibrant colors in a moderately dark room. This image mode emphasizes color saturation.
Photo/sRGB	○	○	Suitable for viewing images taken with a digital camera that supports sRGB in a moderately dark room. This image mode supports the sRGB standard.
Video	—	○	Suitable for watching video taken with a video camera in a moderately dark room.
Cinema	—	○	Suitable for watching media played with video software in a dark room. This image mode enables viewers to enjoy the atmosphere of a movie theater.
User 1 - 5	○*	○*	* Up to 5 user-selected combinations of image quality settings can be stored in the memory. (P110) Stored settings can be selected as an image mode.

○: Compatible —: Not compatible

How to Select an Image Mode

Press the **IMAGE** button on the remote control to select.

The image mode changes each time the **IMAGE** button is pressed. (The displayed image modes vary depending on the selected input signal.)

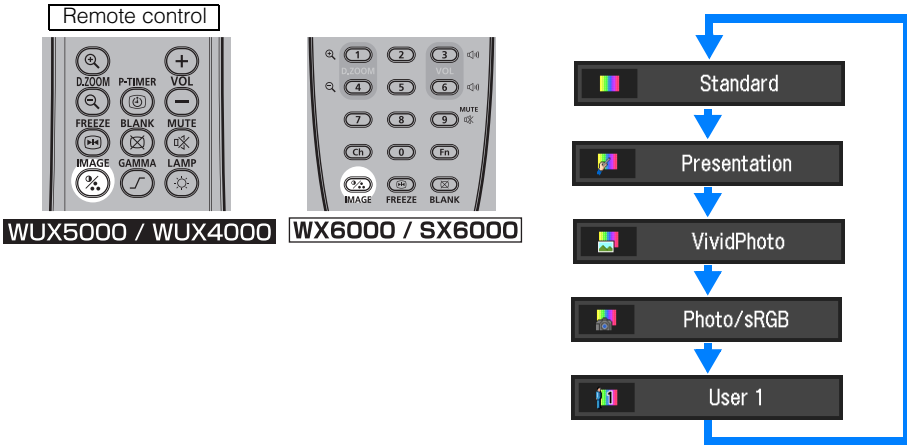

You can also select any image mode from the [Image mode] menu. (P109)

- User settings 1 - 5 are displayed when the desired image settings have been created and stored using the user memory function in the image adjustment menu. (P110)

Turning Off the Projector

1 Press the **POWER** button to display the window shown below.

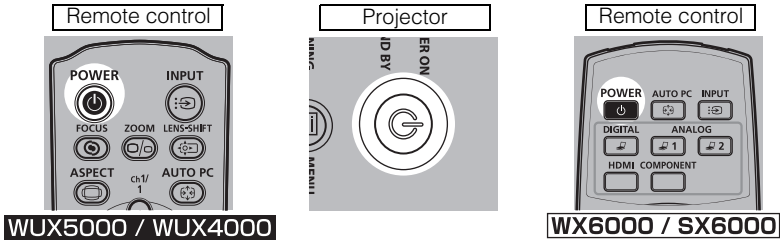

When this window is displayed, press the **POWER** button again to turn off the power. The lamp goes off, the [STAND BY] indicator starts flashing in red and the cooling process starts.



- You cannot turn the projector on while the cooling process is in operation.
- If you want to continue projecting without turning off the power, press a button other than **POWER**, or else wait until the confirmation message disappears.
- After turning off the projector, wait at least 5 minutes before turning it on again. It may shorten the lamp life if you turn on the projector immediately after turning it off.
- Using the projector for a long time may shorten the life of the lamp and internal optical components.

2 Disconnect the power cord from the electrical outlet.

If the power plug is left connected, the [STAND BY] indicator will switch from flashing to constantly illuminated after the cooling process is completed.

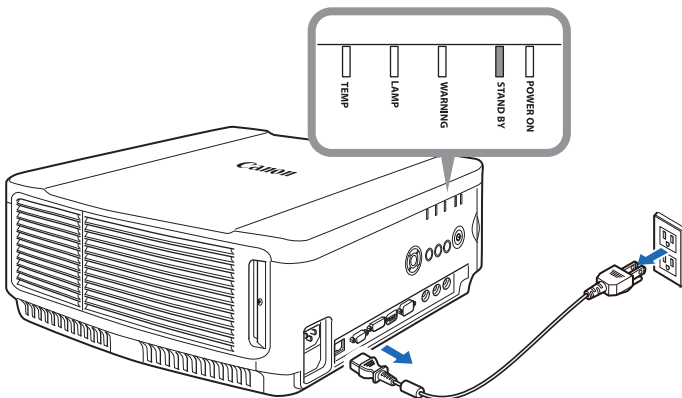

Useful Functions Available During a Presentation

Table of Contents

Safety Instructions

Before Use

Projecting an Image

Useful Functions Available During a Presentation

Setting Functions from Menus

Installation

Connecting to a Network

Maintenance

Appendix

Index

User's Manual

Installation Manual

Appendix

Useful Functions Available During a Presentation

Temporarily Blacking Out an Image

Useful when:

- You have finished the presentation.
- You want to divert attendees' attention from the screen.

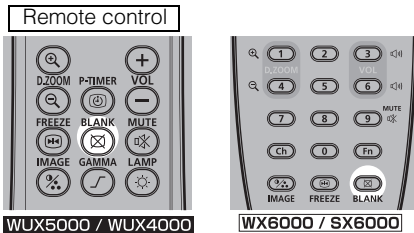

Press the **BLANK** button to black out the image.

Press the **BLANK** button again to show the image.

- You can set the screen state while blacking out the image in the menu. (P106)
- The lamp remains illuminated while the image is blacked out.

Freezing the Picture

Useful when:

- You want to perform a computer operation which is irrelevant to the proceedings of the presentation.
- You want to stop a moving image.

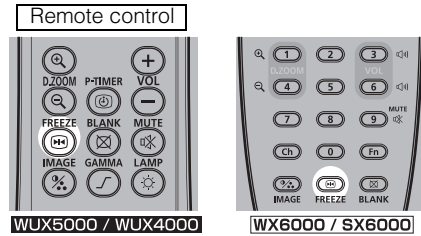

Press the **FREEZE** button to freeze the moving image. The projector shows the following icon.

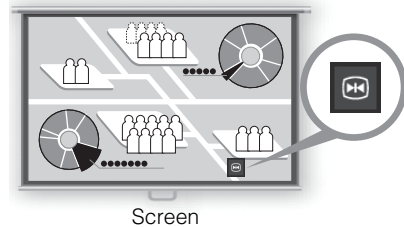

Press the **FREEZE** button again to cancel the FREEZE function.

- It is also cancelled when the input signal is terminated.

Adjusting the Volume

Useful when:

- You want to adjust the volume level of the projector or external speakers.

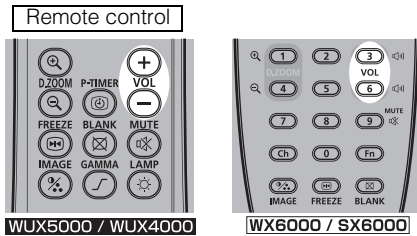

Press the **VOL** button. The following screen appears.

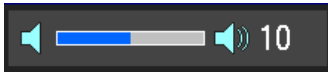

- You can also adjust the volume level with the [◀] / [▶] buttons of the projector.
- Adjust the volume or mute setting on the computer if the volume level is too low.
- You can also adjust the volume level of the speakers connected via the audio output terminal.

⚠ For the WX6000 / SX6000, depending on whether the AUDIO IN terminal has been set in the Audio in terminal select screen (P139), there may be no audio output in some cases.

Muting the Sound

Useful when:

- You want to temporarily mute unnecessary sound.
- You want to immediately mute the sound.

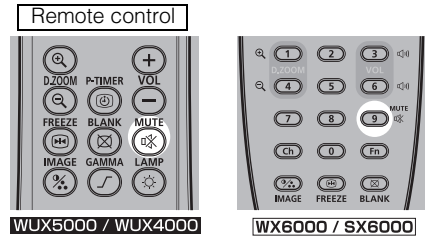

Press the **MUTE** button to mute the sound. The projector shows the following icon.

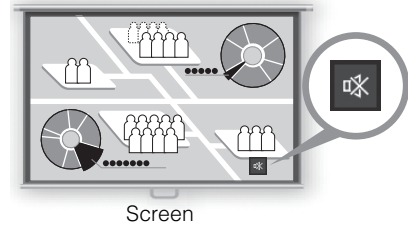

Press the **MUTE** button again to cancel the mute function.

- You can also mute the sound of the speakers connected via the audio output terminal.

Zooming an Image

Useful when:

- Zooming in on an object such as a small graph during a presentation (up to 12x).
- Focusing on the current subject.

Press the + **D.ZOOM** button to enlarge a part of the image. Press the - **D.ZOOM** button to reduce the image size.

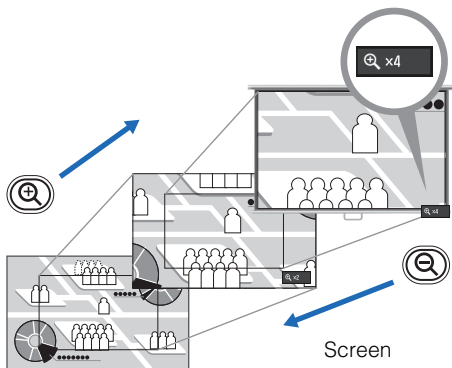
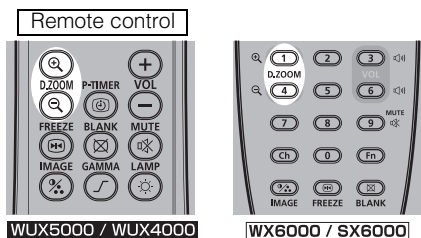

- The magnification appears on the screen.

You can move the area you want to zoom in on by using the [▲] / [▼] / [◀] / [▶] buttons.

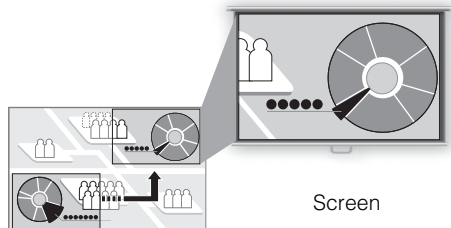
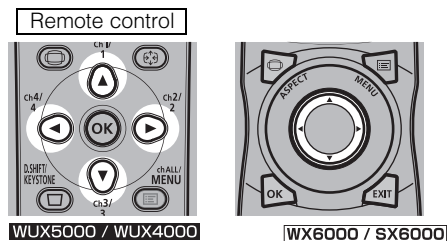

You can restore the original size of the image by pressing the **OK** button.

Showing the Elapsed Time

WUX5000 / WUX4000

Useful when:

- You want to manage the timing of the presentation.

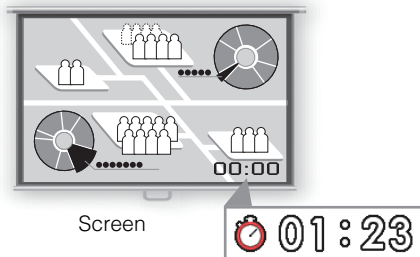

Press the **P-TIMER** button to start counting.

- The elapsed time is displayed on the lower right corner of the screen.
- Time is counted up to 59:59. The timer then returns to 00:00.

Remote control



Press the **P-TIMER** button again to stop the timer.

- Press the **P-TIMER** button while the timer is stopped. The timer disappears from the screen. Then press the **P-TIMER** button to start counting from 00:00.

Setting Functions from Menus

Table of Contents

Safety Instructions

Before Use

Projecting an Image

Useful Functions Available
During a Presentation

Setting Functions from Menus

Installation

Connecting to a Network

Maintenance

Appendix

Index

User's Manual

Installation Manual

Appendix

How to Use Menu

Use the menus to set the operation of the projector in detail.

■ Menu Configuration

WUX5000 / WUX4000

The menu screen is divided into 5 tabs as shown below.

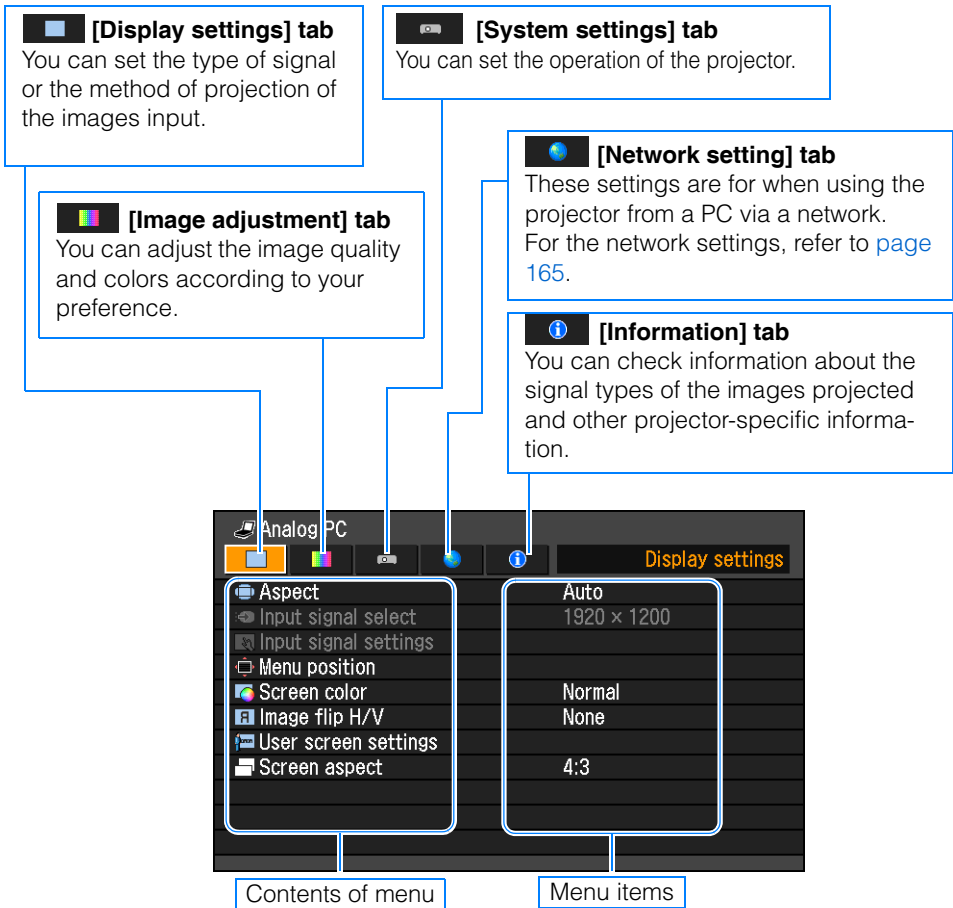

Input Signal Types for which a Menu Item is Displayed

Different menu items are displayed for different input signal types.

In the following explanation of each menu item, the input signal type for which the menu item is displayed is indicated as follows:

- Input signal for which the menu item is displayed
- Input signal for which the menu item is not displayed



WX6000 / SX6000

The menu screen is divided into 6 tabs as shown below.

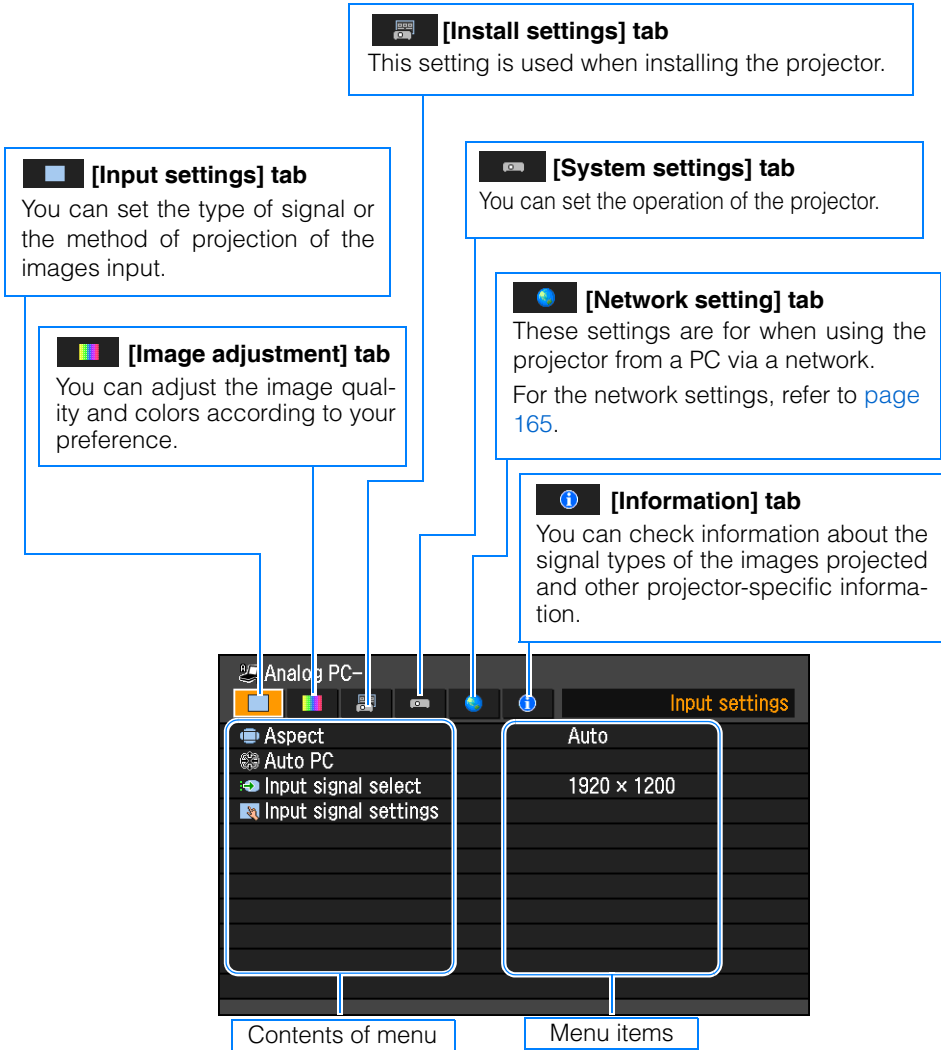

How to Use Menu

Basic Menu Operations

The menus shown below are for WUX5000.

1 Press the [MENU] button to display the menu window.

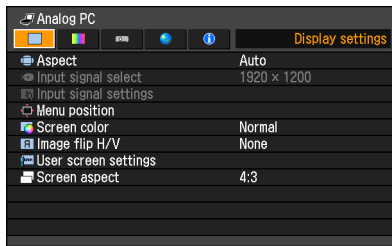
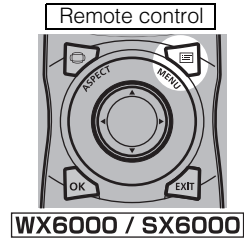
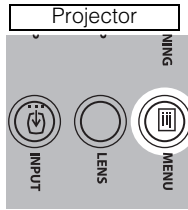
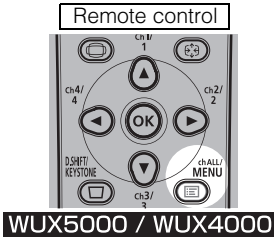

2 Use the [◀] / [▶] buttons to select a tab.

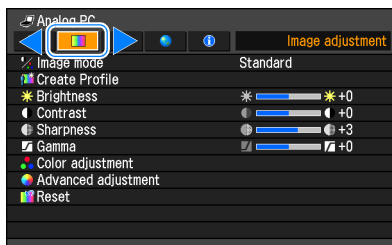
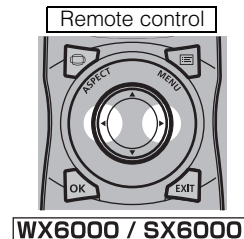
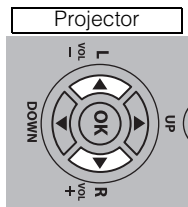
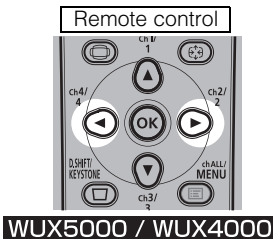

- If the tab position is not highlighted in orange, use the [▲] / [▼] buttons to move the highlight to the top.

3 Use the [▲] / [▼] buttons to select an item.

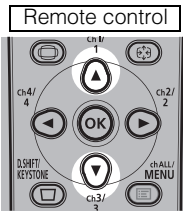

WUX5000 / WUX4000

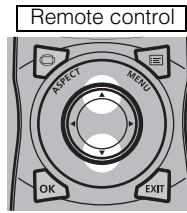
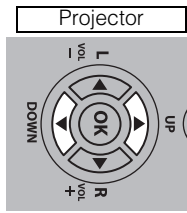

WX6000 / SX6000

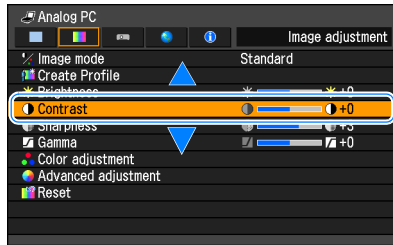

How to Use Menu

4 Select contents.

How to select the contents varies depending on the item.

Selecting from a list Example: Aspect

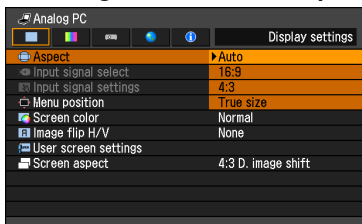

1. Select Aspect.
2. Press the **OK** button or **[▶]** button to display a list of the contents.
3. Use the **[▲]** / **[▼]** buttons to select the desired contents.
4. When you have found the contents you desired, press the **OK** button or **[▶]**.

Adjusting with the **[◀]** / **[▶]** buttons Example: Contrast

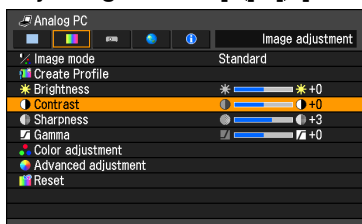

1. Select Contrast.
2. Use the **[◀]** / **[▶]** buttons to adjust the setting.

Selecting from a different screen (1) Example: Menu position

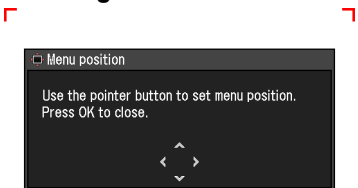

1. Select Menu position.
2. Press the **OK** button to display a different screen.
3. Then follow the instruction on the screen.

Selecting from a different screen (2) Example: Tracking

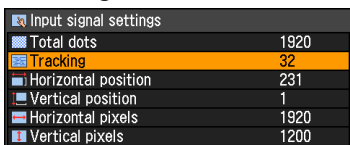

1. Select Input signal settings.
2. Select Tracking.
3. Press the **OK** button to display a different screen.
4. Use the **[▲]** / **[▼]** buttons to select the setting, then use the **[◀]** / **[▶]** buttons to select the value.
5. When you have completed the settings, press the **OK** button.

5 Pressing the MENU button causes the menu screen to disappear.

The menu screen will also disappear if the EXIT button (WX6000 / SX6000) is pressed.

Setting Display Status

Selecting an Image Projection Mode

[Aspect]

- HDMI
- Component
- Digital PC
- Analog PC

You can select a projection mode corresponding to the aspect ratio of the image. (P69)

WUX5000 / WUX4000

MENU > [Display settings] > [Aspect]

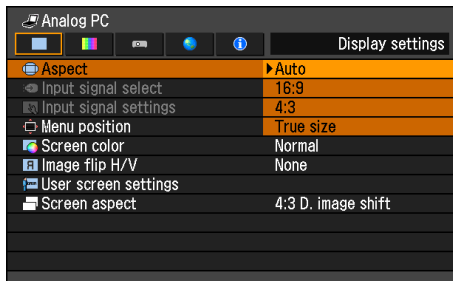

WX6000 / SX6000

MENU > [Input settings] > [Aspect]

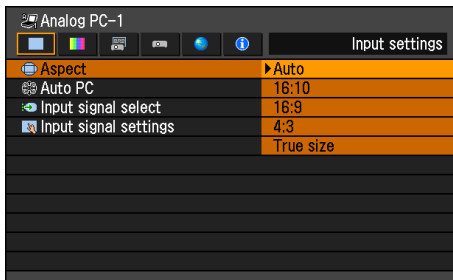

- Different contents are displayed for different screen aspects or input signal types.
- The **ASPECT** button on the remote control can also be used to select the Aspect settings.

Auto An image is projected at the aspect ratio of the input signal. Select this mode for normal image projection.

Full (WUX5000 / WUX4000)

The image is projected using an input signal aspect ratio of 16:10. Select this to project computer screen images with an aspect ratio of 16:10 (WUXGA, WSXGA+, WXGA+ and WXGA (1280 x 800)) fully on the screen.



This can only be selected when the screen aspect is 16:10.

16:10 (WX6000 / SX6000)

The image is projected using an input signal aspect ratio of 16:10.

16:9 The image is projected using an input signal aspect ratio of 16:9. Select this if an image of 16:9 aspect ratio cannot be correctly projected in [Auto] mode.

4:3 The image is projected using an input signal aspect ratio of 4:3. Select this if an image of 4:3 aspect ratio cannot be correctly projected in [Auto] mode.

Zoom This cuts the upper/lower or left/right part of the screen according to the screen aspect and zooms in or out of the center of the image. Select this if a letter box is displayed (black lines at the top/bottom of the screen) when using video software.



There may be some cases when this cannot be selected, depending on the input signal and/or resolution.

True size

The image is projected with the original resolution of the input signal. Select this to clearly project a computer screen image that has a resolution of WUXGA and lower (WUX5000 / WUX4000), WXGA+ and lower (WX6000) or SXGA+ and lower (SX6000).



There may be some cases when this cannot be selected, depending on the input signal and/or resolution.

Press the **OK** button to accept your setting and then press the **MENU** button or **EXIT** button (WX6000 / SX6000).

Automatic Display Adjustment

[Auto PC]

- HDMI
- Component
- Digital PC
- Analog PC

Automatically adjusts display position misalignment and screen flickering. The adjusted result is stored in the memory.

WX6000 / SX6000

MENU > [Input settings] > [Auto PC]

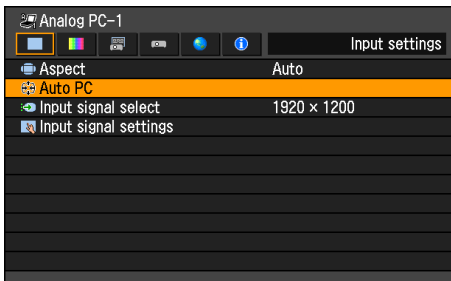

Press the **OK** button to accept your setting and then press the **MENU** button or **EXIT** button (WX6000 / SX6000).



If [Auto PC] adjustment is insufficient, perform the following operations.

- Select the input signal that matches the resolution of the computer from [Input signal select]. (P94)
- If adjustment is insufficient even when using the above operation, adjust [Total dots], [Tracking], [Horizontal/Vertical position] and [Horizontal/Vertical pixels] in [Input signal settings]. (P95 – P98)
- For details about signal formats that are compatible with the projector, refer to [page 218](#).

Selecting an Input Signal Type (Analog PC)

[Input signal select]

- HDMI
- Component
- Digital PC
- Analog PC

You can select a suitable resolution if the auto PC adjustment function (P62) cannot project the correct image from a computer.

WUX5000 / WUX4000

MENU > [Display settings] > [Input signal select]

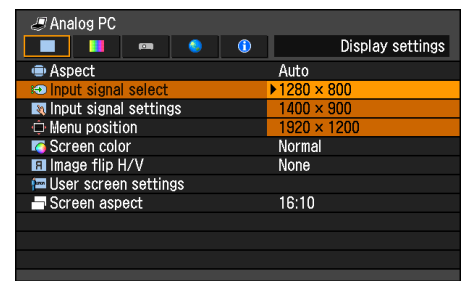

WX6000 / SX6000

MENU > [Input settings] > [Input signal select]

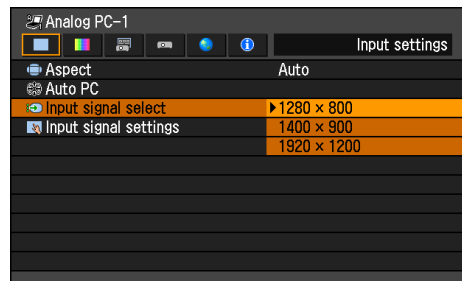

Press the **OK** button to accept your setting and then press the **MENU** button or **EXIT** button (WX6000 / SX6000).

Select an input signal corresponding to the resolution of the computer.

- For the signal types supported by the projector, see the table on [page 218](#).

Selecting an Input Signal Type (Component)

[Input signal select]

- | | |
|----------------------------------|---------------------------------|
| <input type="radio"/> HDMI | <input type="radio"/> Component |
| <input type="radio"/> Digital PC | <input type="radio"/> Analog PC |

You can select the proper component signal type if the video image from AV equipment is not projected correctly.

WUX5000 / WUX4000

MENU > [Display settings]> [Input signal select]

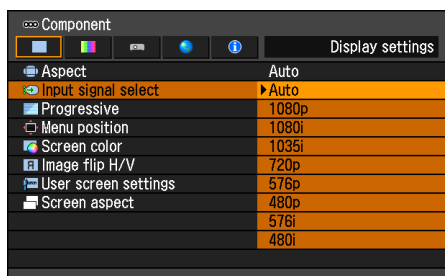

Press the **OK** button to accept your setting and then press the **MENU** button.

- [Auto] is the factory default.
- Refer to the user's manual for the AV equipment connected to the projector to confirm the component signal type.

Adjust Input Signal Type (Analog PC) Total Dots

[Total dots]

- | | |
|----------------------------------|---------------------------------|
| <input type="radio"/> HDMI | <input type="radio"/> Component |
| <input type="radio"/> Digital PC | <input type="radio"/> Analog PC |

You can adjust the total number of dots in the horizontal direction.

Adjust it when stripes are displayed on the screen.

WUX5000 / WUX4000

MENU > [Display settings]> [Input signal settings] > [Total dots]

WX6000 / SX6000

MENU > [Input settings] > [Input signal settings] > [Total dots]

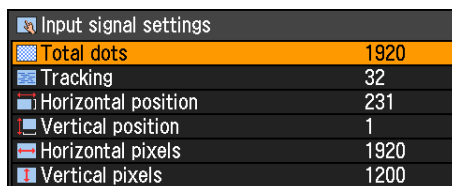

Use [**◀**] / [**▶**] to select a value.

When you have completed the adjustment, press the **OK** button to accept your setting and then press the **MENU** button or **EXIT** button (WX6000 / SX6000).

- Perform this adjustment if the [AUTO PC] function (P62) cannot adjust the projected image correctly.

Adjust Input Signal Type (Analog PC) Tracking

[Tracking]

- HDMI
- Digital PC
- Component
- Analog PC

You can fine-tune the timing for generating an image from the image signal. Adjusts the tracking when the image distorts or flickers.

WUX5000 / WUX4000

MENU > [Display settings]> [Input signal settings] > [Tracking]

WX6000 / SX6000

MENU > [Input settings] > [Input signal settings] > [Tracking]

Input signal settings	
Total dots	1920
Tracking	32
Horizontal position	231
Vertical position	1
Horizontal pixels	1920
Vertical pixels	1200

Use [◀] / [▶] to select a value. When you have completed the adjustment, press the **OK** button to accept your setting and then press the **MENU** button or **EXIT** button (WX6000 / SX6000).

- Perform this adjustment if the [AUTO PC] function (P62) cannot adjust the projected image correctly.

Adjust Input Signal Type (Analog PC) Horizontal Position

[Horizontal position]

- HDMI
- Digital PC
- Component
- Analog PC

You can adjust the horizontal position of the screen when the projected image is shifted in the horizontal direction.

WUX5000 / WUX4000

MENU > [Display settings]> [Input signal settings] > [Horizontal position]

WX6000 / SX6000

MENU > [Input settings] > [Input signal settings] > [Horizontal position]

Input signal settings	
Total dots	1920
Tracking	32
Horizontal position	231
Vertical position	1
Horizontal pixels	1920
Vertical pixels	1200

Use [◀] / [▶] to select a value. As the value increases, the screen moves to the left.

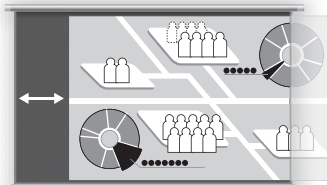

Screen

When you have completed the adjustment, press the **OK** button to accept your setting and then press the **MENU** button or **EXIT** button (WX6000 / SX6000).

- Perform this adjustment if the [AUTO PC] function (P62) cannot adjust the projected image correctly.

Adjust Input Signal Type (Analog PC) Vertical Position

[Vertical position]

- HDMI
- Component
- Digital PC
- Analog PC

You can adjust the vertical position of the screen when the projected image is shifted in the vertical direction.

WUX5000 / WUX4000

MENU > [Display settings]> [Input signal settings] > [Vertical position]

WX6000 / SX6000

MENU > [Input settings] > [Input signal settings] > [Vertical position]

Input signal settings	
Total dots	1920
Tracking	32
Horizontal position	231
Vertical position	1
Horizontal pixels	1920
Vertical pixels	1200

Use [◀] / [▶] to select a value. As the value increases, the screen moves upward.

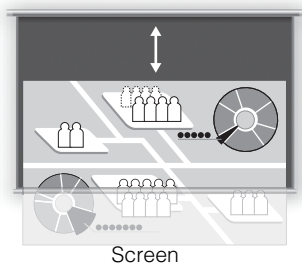

When you have completed the adjustment, press the **OK** button to accept your setting and then press the **MENU** button or **EXIT** button (WX6000 / SX6000).

- Perform this adjustment if the [AUTO PC] function (P62) cannot adjust the projected image correctly.

Adjust Input Signal Type (Analog PC) Horizontal Pixels

[Horizontal pixels]

- HDMI
- Component
- Digital PC
- Analog PC

You can adjust the number of the pixels in the horizontal direction if the length of the screen is too long or too short in the horizontal direction.

WUX5000 / WUX4000

MENU > [Display settings]> [Input signal settings] > [Horizontal pixels]

WX6000 / SX6000

MENU > [Input settings] > [Input signal settings] > [Horizontal pixels]

Input signal settings	
Total dots	1920
Tracking	32
Horizontal position	231
Vertical position	1
Horizontal pixels	1920
Vertical pixels	1200

Use [◀] / [▶] to select a value.

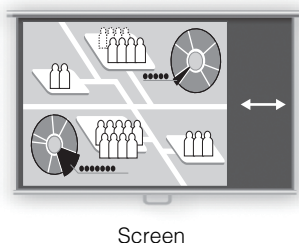

When you have completed the adjustment, press the **OK** button to accept your setting and then press the **MENU** button or **EXIT** button (WX6000 / SX6000).

- Perform this adjustment if the [AUTO PC] function (P62) cannot adjust the projected image correctly.

Adjust Input Signal Type (Analog PC) Vertical Pixels

[Vertical pixels]

- | | |
|-------------------------------------|------------------------------------|
| <input type="checkbox"/> HDMI | <input type="checkbox"/> Component |
| <input type="checkbox"/> Digital PC | <input type="radio"/> Analog PC |

You can adjust the number of the pixels in the vertical direction if the screen is too long or too short in the vertical direction.

WUX5000 / WUX4000

MENU > [Display settings] > [Input signal settings] > [Vertical pixels]

WX6000 / SX6000

MENU > [Input settings] > [Input signal settings] > [Vertical pixels]

Input signal settings	
Total dots	1920
Tracking	32
Horizontal position	231
Vertical position	1
Horizontal pixels	1920
Vertical pixels	1200

Use [◀] / [▶] to select a value.

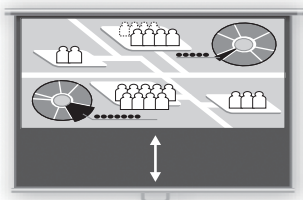

Screen

When you have completed the adjustment, press the **OK** button to accept your setting and then press the **MENU** button or **EXIT** button (WX6000 / SX6000).

- Perform this adjustment if the [AUTO PC] function (P62) cannot adjust the projected image correctly.

Selecting HDMI Input Level

[HDMI input level]

- | | |
|-------------------------------------|------------------------------------|
| <input type="radio"/> HDMI | <input type="checkbox"/> Component |
| <input type="checkbox"/> Digital PC | <input type="checkbox"/> Analog PC |

You can select this as required when you project visual software with an HDMI signal.

WUX5000 / WUX4000

MENU > [Display settings] > [HDMI input level]

HDMI	
Aspect	Auto
HDMI input level	Auto
HDMI color space	Normal
HDMI over scan	Expanded
Progressive	
Menu position	
Screen color	Normal
Image flip H/V	None
User screen settings	
Screen aspect	4:3

WX6000 / SX6000

MENU > [Input settings] > [HDMI input level]

HDMI	
Aspect	Auto
HDMI input level	Auto
HDMI color space	Normal
HDMI over scan	Expanded
Progressive	Auto

Press the **OK** button to accept your setting and then press the **MENU** button or **EXIT** button (WX6000 / SX6000).

- [Auto] is the factory default.
- You can select this only when the type of signal sent from AV equipment is RGB.
- The signal level is selected automatically in [Auto] mode. (Some AV equipment may not support this.)
- If the HDMI output of your AV equipment allows switching between [Normal] and

[Expanded], we recommend you to set [Expanded]. The contrast of images will be improved and dark scenes will be rendered more realistically. In this case, select [Auto] or [Expanded] for the HDMI input level. For more detailed information, refer to the user's manual for the AV equipment connected to the projector.

HDMI Color Format

[HDMI color space]

- HDMI
- Digital PC
- Component
- Analog PC

Select the color space for the HDMI signal.

WUX5000 / WUX4000

MENU > [Display settings] > [HDMI color space]

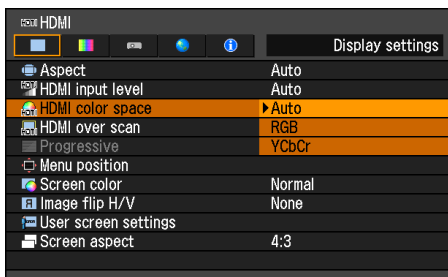

WX6000 / SX6000

MENU > [Input settings] > [HDMI color space]

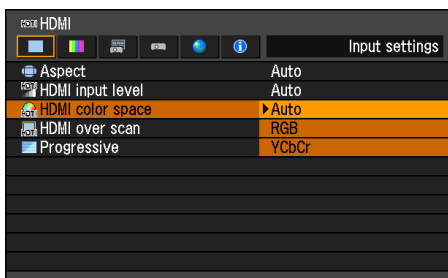

Auto	Selects the optimal color format for the input HDMI signal.
RGB	Forces the projector to handle the input signal as an RGB signal.
YCbCr	Forces the projector to handle the input signal as a color difference signal.

Press the **OK** button to accept your setting and then press the **MENU** button or **EXIT** button (WX6000 / SX6000).

- [Auto] is the factory default.

Setting Display Status

Select HDMI Over Scan

[HDMI over scan]

- HDMI — Component
- Digital PC — Analog PC

You can select this as required when you project visual software using an HDMI signal.

WUX5000 / WUX4000

MENU > [Display settings] > [HDMI over scan]

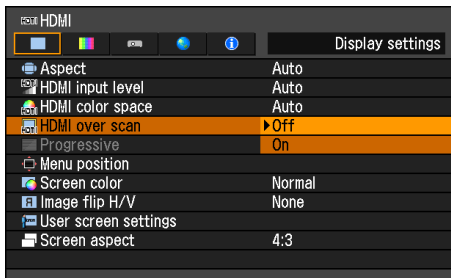

WX6000 / SX6000

MENU > [Input settings] > [HDMI over scan]

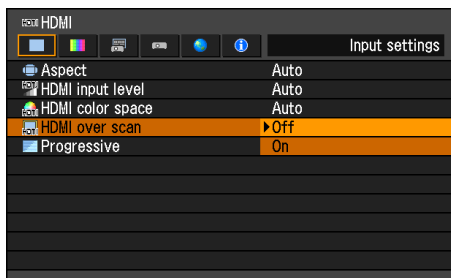

Off The entire input signal (100%) is projected. The images projected may be smaller than the full projection screen.

On Images are projected with distortion at the peripheral section of images trimmed off. (The central 95% of the images are projected.) Part of the peripheral sections of images may be cut out depending on the resolution of the signal. In such a case, select [Off].

Press the **OK** button to accept your setting and then press the **MENU** button or **EXIT** button (WX6000 / SX6000).

- The factory default settings are [On] when [HDMI In] (P127) is set for [Auto] and [Off] when it is set for [Computer].

Performing Progressive Processing

[Progressive]

- | | |
|----------------------------------|---------------------------------|
| <input type="radio"/> HDMI | <input type="radio"/> Component |
| <input type="radio"/> Digital PC | <input type="radio"/> Analog PC |

You can select this as required when the images have low resolution.

WUX5000 / WUX4000

MENU > [Display settings] > [Progressive]

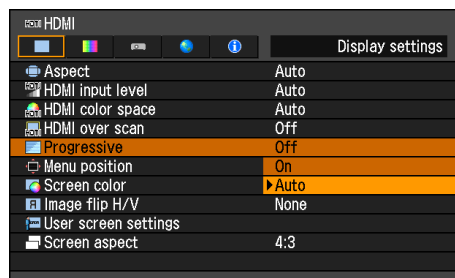

WX6000 / SX6000

MENU > [Input settings] > [Progressive]

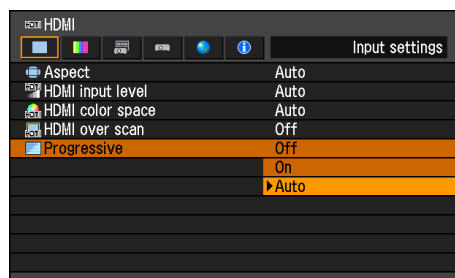

Off	Does not perform progressive processing.
On	Performs progressive processing. This mode is available when the HDMI signal is 1080i, or component signal is 1080i, 1035i, 576i or 480i.
Auto	Performs the appropriate progressive processing according to the input signal.

Press the OK button to accept your setting and then press the MENU button or EXIT button (WX6000 / SX6000).

- [Auto] is the factory default.
- When [HDMI In] (P127) is [Computer], this can only be set when the input signal is 1080i, 1035i, 576i or 480i and the input signal color space is YCbCr422.
- Select [Off] when flickers and horizontal lines are noticeable in media that has a lot of fast-moving action.

Setting Display Status

Selecting a Menu Position

[Menu position]

- HDMI
- Component
- Digital PC
- Analog PC

You can change the position of menus displayed.

WUX5000 / WUX4000

MENU > [Display settings] > [Menu position]

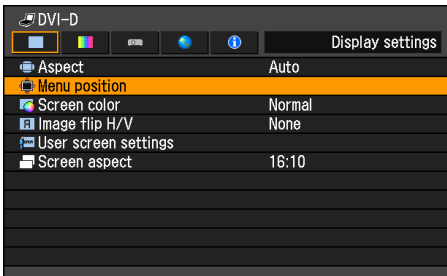

WX6000 / SX6000

MENU > [Install settings] > [On screen] > [Menu position]

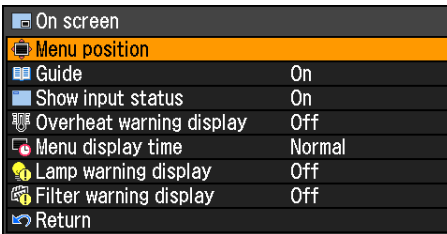

Move the menu to the desired position with the [▲] / [◀] / [▼] / [▶] buttons.



When the menu has been moved to the desired position, press the **OK**, **MENU** or **EXIT** button (WX6000 / SX6000).

Correcting the Screen Color

[Screen color]

- | | |
|----------------------------------|---------------------------------|
| <input type="radio"/> HDMI | <input type="radio"/> Component |
| <input type="radio"/> Digital PC | <input type="radio"/> Analog PC |

You can adjust the color quality of the images projected according to the color of the projection screen.

WUX5000 / WUX4000

MENU > [Display settings] > [Screen color]

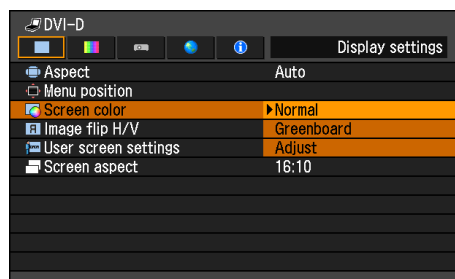

WX6000 / SX6000

MENU > [Install settings] > [Screen color]

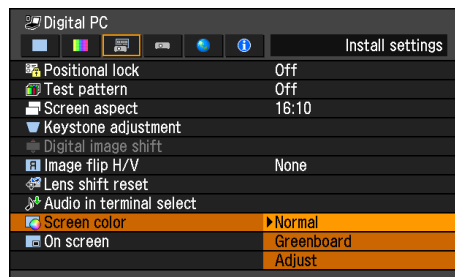

Normal Select this if a standard type of projection screen is used. The images are projected in a light quality similar to that of natural light.

Green-board Select this if a greenboard (dark green color) is used for the projection screen. The color quality similar to [Normal] is obtained on the greenboard.

Adjust Select this to make detailed adjustment. The following popup screen will appear.

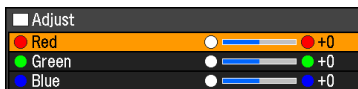

Use the [▲] / [▼] buttons to select a primary color.

[▶] makes the color selected darker.

[◀] makes the color selected lighter.

Press the **OK** button to accept your setting and then press the **MENU** button or **EXIT** button (WX6000 / SX6000).

- [Normal] is the factory default.

Setting Display Status

Reversing Projection

[Image flip H/V]

- | | |
|----------------------------------|---------------------------------|
| <input type="radio"/> HDMI | <input type="radio"/> Component |
| <input type="radio"/> Digital PC | <input type="radio"/> Analog PC |

Select this setting if you want to hang the projector from the ceiling or project an image from behind the screen.

WUX5000 / WUX4000

MENU > [Display settings] > [Image flip H/V]

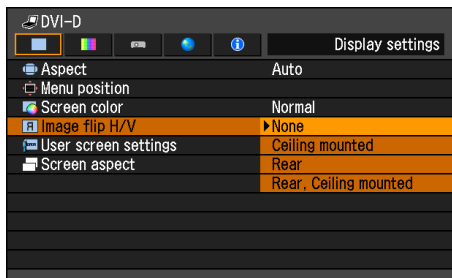

WX6000 / SX6000

MENU > [Install settings] > [Image flip H/V]

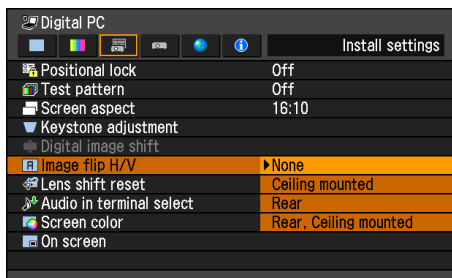

None Select this to project an image normally.

Ceiling mounted Select this to project an image with the projector hung from the ceiling. The projected image is inverted in both vertical and horizontal directions.

Rear Select this to project an image from behind the screen. The projected image is inverted in the horizontal direction.

Rear, Ceiling mounted Select this to project an image from behind the screen with the projector hung from the ceiling. The projected image is inverted in the vertical direction.

Press the **OK** button to accept your setting and then press the **MENU** button or **EXIT** button (WX6000 / SX6000).

- [None] is the factory default.

Normal projection (none)

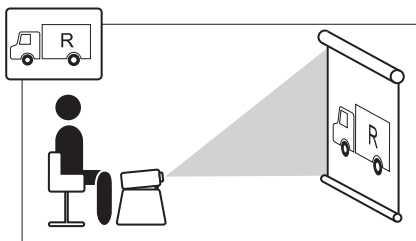

Ceiling mounted projection

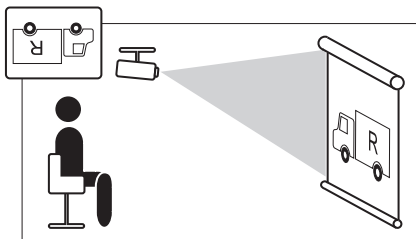

Rear projection

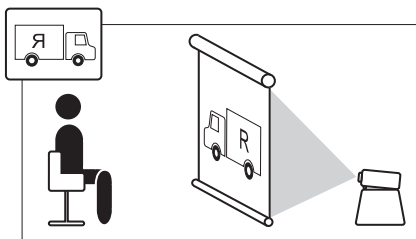

Rear ceiling mounted projection

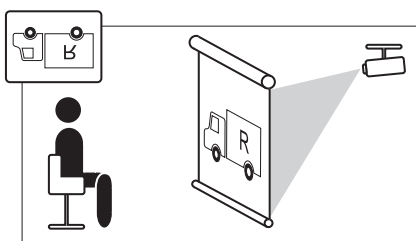

- To hang the projector from the ceiling, use the optional bracket. Contact the Canon Customer Support Center for more detailed information.
- If you flip the image, the keystone distortion adjustment will be reset.

No Signal Screen

[No signal screen]

- HDMI Component
 Digital PC Analog PC

You can display either a black or blue screen when there is no input signal.

WUX5000 / WUX4000

MENU > [Display settings]> [User screen settings] > [No signal screen]

WX6000 / SX6000

MENU > [System settings] > [User screen settings] > [No signal screen]

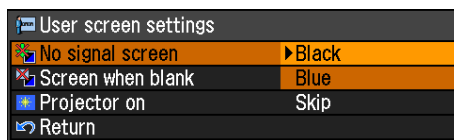

Black	The screen is all black.
Blue	The screen is all blue.

Press the **OK** button to accept your setting and then press the **MENU** button or **EXIT** button (WX6000 / SX6000).

- [Blue] is the factory default.

Setting Display Status

Screen When Blank

[Screen when blank]

- HDMI
- Component
- Digital PC
- Analog PC

You can display a black or blue screen and temporarily blank out the projected image by pressing the **BLANK** button on the remote control.

WUX5000 / WUX4000

MENU > [Display settings] > [User screen settings] > [Screen when blank]

WX6000 / SX6000

MENU > [System settings] > [User screen settings] > [Screen when blank]

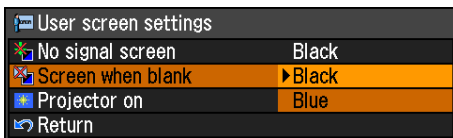

Black	The screen is all black.
Blue	The screen is all blue.

Press the **OK** button to accept your setting and then press the **MENU** button or **EXIT** button (WX6000 / SX6000).

- [Black] is the factory default.

Selecting a Logo at Startup

[Projector on]

- HDMI
- Component
- Digital PC
- Analog PC

You can display a specified logo on the screen from the moment the projector is turned on to the moment it is ready for projection.

WUX5000 / WUX4000

MENU > [Display settings] > [User screen settings] > [Projector on]

WX6000 / SX6000

MENU > [System settings] > [User screen settings] > [Projector on]

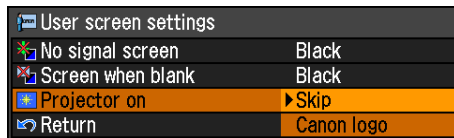

Skip	Projects an input signal immediately after turning on the projector.
Canon logo	Displays the Canon logo that was registered in advance at the factory.

Press the **OK** button to accept your setting and then press the **MENU** button or **EXIT** button (WX6000 / SX6000).

- [Canon logo] is the factory default.

Selecting Aspect Ratio of Screen

[Screen aspect]

- HDMI Component
 Digital PC Analog PC

Select according to the aspect ratio of the projection screen. (P63)

WUX5000 / WUX4000

MENU > [Display settings] > [Screen aspect]

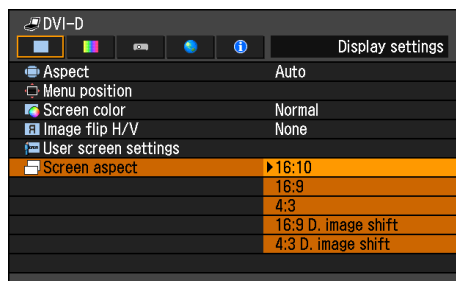

WX6000 / SX6000

MENU > [Install settings] > [Screen aspect]

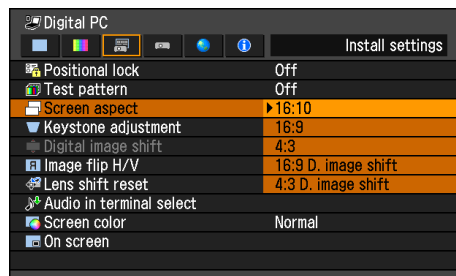

16:10	Select this when you use a screen with an aspect ratio of 16:10.
16:9	Select this when you use a screen with an aspect ratio of 16:9.
4:3	Select this when you use a screen with an aspect ratio of 4:3.
16:10 D image shift (SX6000)	Select this when the screen aspect ratio is 16:10. Keystone correction cannot be performed in this mode. However when projecting level, it is possible to shift the image up or down. For details about how to shift the image, refer to page 67 .

16:9 D. image shift
Select this when you use a screen with an aspect ratio of 16:9. Keystone correction cannot be performed in this mode. However, it is possible to move the image up / down when projecting level. For details about how to move the image, refer to [page 67](#).

4:3 D. image shift (Except for SX6000)
Select this when you use a screen with an aspect ratio of 4:3. Keystone correction cannot be performed in this mode. However, it is possible to move the image left / right when projecting level. For details about how to move the image, refer to [page 68](#).

Press the **OK** button to accept your setting and then press the **MENU** button or **EXIT** button (WX6000 / SX6000).

- The factory default is [16:10] for the WUX5000 / WUX4000 / WX6000, and [4:3] for the SX6000.
- If you select [16:9 D. image shift], [4:3 D. image shift], or [16:10 D. image shift] (for SX6000), the keystone correction will be canceled. For more details, refer to [page 66](#).
- [Auto] may be automatically selected for the aspect depending on the screen aspect setting.

Adjusting Keystone Distortion

[Keystone adjustment]

- | | |
|----------------------------------|---------------------------------|
| <input type="radio"/> HDMI | <input type="radio"/> Component |
| <input type="radio"/> Digital PC | <input type="radio"/> Analog PC |

Corrects keystone distortion.

WX6000 / SX6000

MENU > [Install settings] > [Keystone adjustment]

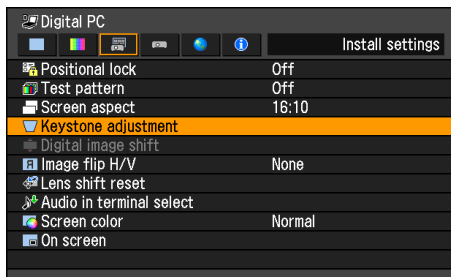

If the **OK** button or **[▶]** button is pressed, the Keystone adjustment screen is displayed.

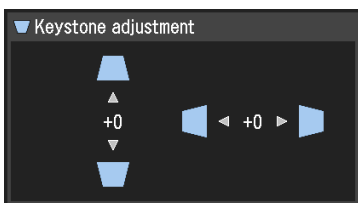

Correct using the **[▲]** / **[◀]** / **[▼]** / **[▶]** buttons. When you have finished correcting, press the **OK** button.

- This cannot be selected when the screen aspect is 16:9D image shift, 16:10D image shift or 4:3D image shift.
- The Keystone adjustment screen can also be displayed by pressing the **KEYSTONE** button on the remote control. (P76)

Image Shift Adjustment

[Digital image shift]

- | | |
|----------------------------------|---------------------------------|
| <input type="radio"/> HDMI | <input type="radio"/> Component |
| <input type="radio"/> Digital PC | <input type="radio"/> Analog PC |

Moves the position of the projected image.

WX6000 / SX6000

MENU > [Install settings] > [Digital image shift]

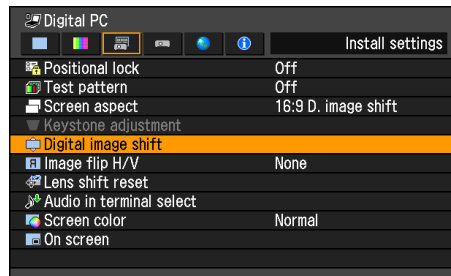

If the **OK** button or **[▶]** button is pressed, the D image shift adjustment screen is displayed.

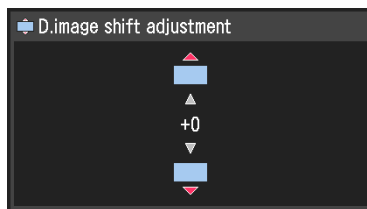

Correct using the **[▲]** / **[▼]** buttons. When you have finished correcting, press the **OK** button.

- This cannot be selected when the screen aspect is 16:9, 16:10 or 4:3.
- When the screen aspect is 16:9D image shift or 16:10D image shift (SX6000), the image can be adjusted vertically, and when the screen aspect is 4:3D image shift (WX6000), it can be adjusted horizontally.

Selecting an Image Quality

Image Adjustment

[Image mode]

- | | |
|----------------------------------|---------------------------------|
| <input type="radio"/> HDMI | <input type="radio"/> Component |
| <input type="radio"/> Digital PC | <input type="radio"/> Analog PC |

You can select an image mode suitable for the projected image. (P78)

You can also select it with the **IMAGE** button on the remote control. (P79)

WUX5000 / WUX4000

MENU > [Image adjustment] > [Image mode]

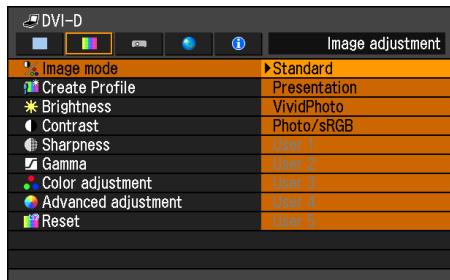

(The screen is for the WUX5000.)

WX6000 / SX6000

MENU > [Image adjustment] > [Image mode]

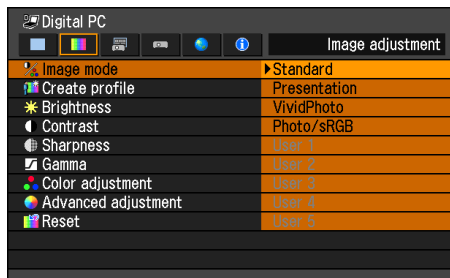

Standard Suitable for projecting a computer screen or watching media played with video software in a brightish room.
This image mode emphasizes white tones.

Presentation Suitable for viewing text-based images in a brightish room.

Dynamic Suitable for watching media played with video software in a brightish room.

VividPhoto Suitable for viewing images with vibrant colors in a moderately dark room.
This image mode emphasizes color saturation.

Photo/sRGB Suitable for projecting images taken with a digital camera that supports sRGB in a moderately dark room. Supports the sRGB standard.

Video Suitable for watching video taken with a video camera in a moderately dark room.

Cinema Suitable for watching media played with video software in a dark room.
This image mode enables viewers to enjoy the atmosphere of a movie theater.

User 1 - 5 Up to 5 user-selected combinations of image quality settings can be stored in the memory. (P110)
Stored settings can be selected as an image mode.

Press the **OK** button to accept your setting and then press the **MENU** button or **EXIT** button (WX6000 / SX6000).

- [Standard] is the factory default.
- You can adjust the image quality by adjusting the following items in each image mode:
[Brightness], [Contrast], [Sharpness], [Gamma], [Color adjustment], [Advanced adjustment] and [Lamp mode] (WUX4000)
- The adjustment you have made is stored as each combination of input signals and an image mode.
- When a user memory that was saved in [Create profile] is selected, [Baseline Image Mode] appears in the menu. This indicates the image mode that was the base when the user memory was saved.

Selecting an Image Quality

WUX5000 / WUX4000

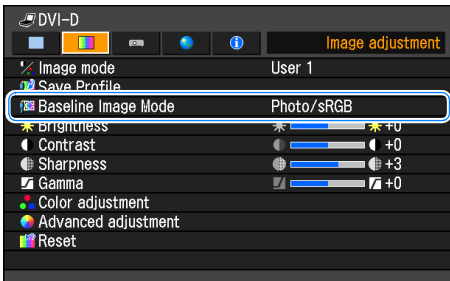

(The screen is for the WUX5000.)

WX6000 / SX6000

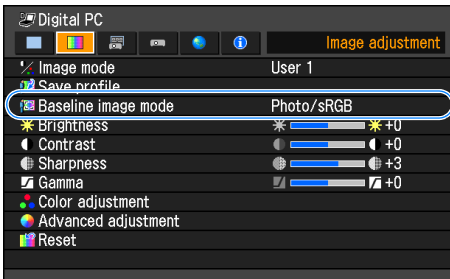

Saving the Desired Image Quality

[Create profile]

- HDMI
- Component
- Digital PC
- Analog PC

Up to 5 combinations of image quality settings can be stored. The stored image quality can be selected as an image mode.

WUX5000 / WUX4000

MENU > [Image adjustment] > [Create Profile]

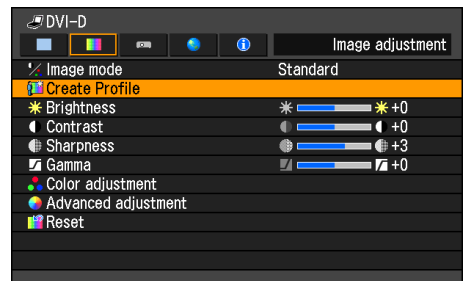

(The screen is for the WUX5000.)

WX6000 / SX6000

MENU > [Image adjustment] > [Create profile]

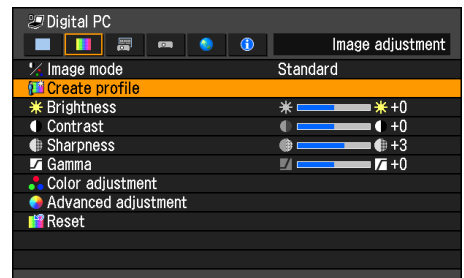

Use the [▲] / [▼] buttons and select the save destination. (Saved memories are indicated by checkmarks.)

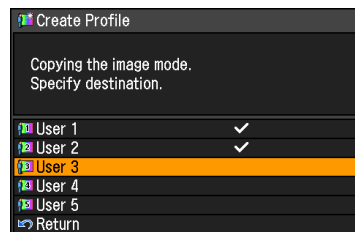

When the desired save destination is selected, press the **OK** button to accept your setting and then press the [Return] button.

- The saved settings consist of the brightness, contract, sharpness, gamma, color adjustment, advanced adjustment, and lamp mode (WUX4000).
- The number of displayed user memories is 5, however it is possible to save different settings for when the connected equipment is a computer (ANALOG PC, DIGITAL PC or HDMI (when [HDMI In] (P127) is [Computer]) and when AV equipment is connected (COMPONENT, HDMI (when [HDMI In] (P127) is [Auto])). As a result, it is possible to save up to 10 settings.
- The image mode name which was the basis for the settings change is also saved in the user memory. When a user memory is selected as the image mode, the image mode that was the base for that user memory is displayed in the menu as [Baseline image mode].

Adjusting the Brightness

[Brightness]

- | | |
|----------------------------------|---------------------------------|
| <input type="radio"/> HDMI | <input type="radio"/> Component |
| <input type="radio"/> Digital PC | <input type="radio"/> Analog PC |

You can adjust the brightness of images.

WUX5000 / WUX4000

MENU > [Image adjustment] > [Brightness]

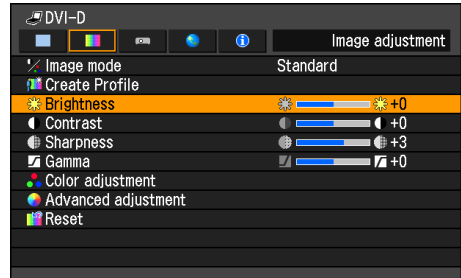

(The screen is for the WUX5000.)

WX6000 / SX6000

MENU > [Image adjustment] > [Brightness]

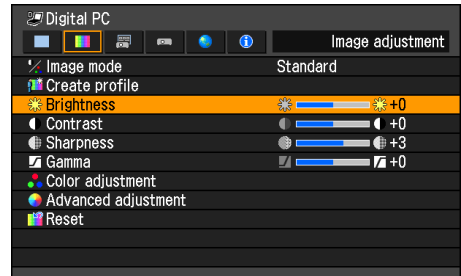

Increases the brightness of an image.

Decreases the brightness of an image.

When you have completed the adjustment, press the **OK** button to accept your setting and then press the **MENU** button or **EXIT** button (WX6000 / SX6000).

- The adjustment you have made is stored as adjusted values for the input signals and image mode of the current projection.

Selecting an Image Quality

Adjusting the Contrast

[Contrast]

- HDMI
- Component
- Digital PC
- Analog PC

You can adjust the contrast of images. Adjust the difference between the light and dark parts of the image to produce an image with emphasized contrast or an image that is soft.

WUX5000 / WUX4000

MENU > [Image adjustment] > [Contrast]



(The screen is for the WUX5000.)

WX6000 / SX6000

MENU > [Image adjustment] > [Contrast]

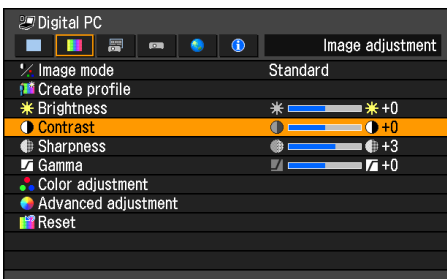

[▶] Increases the contrast of an image. This emphasizes the darker and brighter parts of the image on the projected image.

[◀] Decreases the contrast of an image. The image becomes less vivid.

When you have completed the adjustment, press the **OK** button to accept your setting and then press the **MENU** button or **EXIT** button (WX6000 / SX6000).

- The adjustment you have made is stored as adjusted values for the input signals and image mode of the current projection.

Adjusting the Sharpness

[Sharpness]

- HDMI
- Component
- Digital PC
- Analog PC

You can adjust the sharpness of images.

WUX5000 / WUX4000

MENU > [Image adjustment] > [Sharpness]

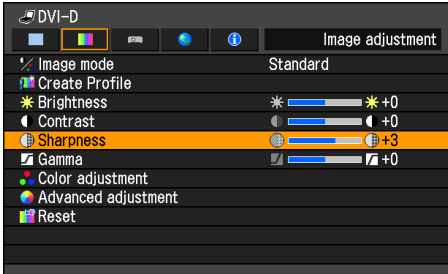

(The screen is for the WUX5000.)

WX6000 / SX6000

MENU > [Image adjustment] > [Sharpness]

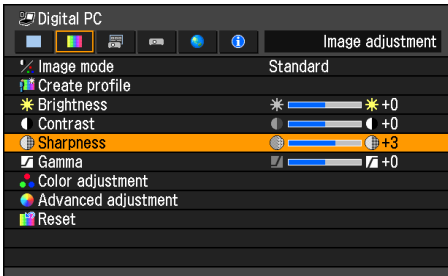

[▶] Increases the sharpness of an image.

[◀] Decreases the sharpness of an image.

When you have completed the adjustment, press the **OK** button to accept your setting and then press the **MENU** button or **EXIT** button (WX6000 / SX6000).

- The adjustment you have made is stored as adjusted values for the input signals and image mode of the current projection.

Performing Gamma Correction

[Gamma]

- HDMI
- Component
- Digital PC
- Analog PC

You can correct portions of an image that are difficult to see because they are too dark or bright.

For the WUX5000 / WUX4000, correction can be made by using the GAMMA button on the remote control.

WUX5000 / WUX4000

MENU > [Image adjustment] > [Gamma]

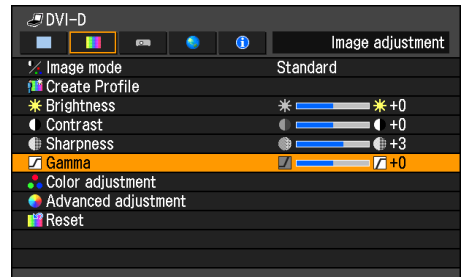

(The screen is for the WUX5000.)

WX6000 / SX6000

MENU > [Image adjustment] > [Gamma]

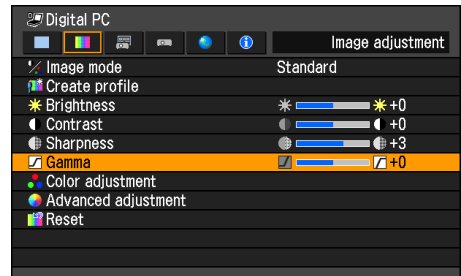

[▶] Brightens the dark portion

[◀] Darkens the bright portion

When you have completed the adjustment, press the **OK** button to accept your

Selecting an Image Quality

setting and then press the **MENU** button or **EXIT** button (WX6000 / SX6000).

- The adjustment you have made is stored as adjusted values for the input signals and image mode of the current projection.
- More detailed adjustment is possible by using the detailed gamma correction (P118).

Adjusting Color

[Color adjustment]

- | | |
|----------------------------------|---------------------------------|
| <input type="radio"/> HDMI | <input type="radio"/> Component |
| <input type="radio"/> Digital PC | <input type="radio"/> Analog PC |

You can adjust the color depth and hue of images for each primary color, red, green and blue. The color temperature can also be adjusted.

MENU > [Image adjustment] > [Color adjustment]

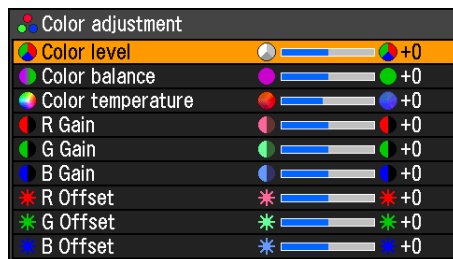

Color level	Adjusts the intensity of each color. [▶] Increases the intensity of color. [◀] Decreases the intensity of color.
Color balance	Adjusts the color balance of a purplish or greenish image. [▶] Corrects a purplish image. [◀] Corrects a greenish image.
Color temperature	Adjusts the color temperature of the image. [▶] Changes to a bluish color (cold color). [◀] Changes to a reddish color (warm color).
R / G / B Gain	Adjust the intensity of each color. [▶] Increases the color intensity. [◀] Decreases the color intensity.
R / G / B Offset	Adjusts the color reproducibility of dark portions of each color. [▶] Increases the color reproducibility. [◀] Decreases the color reproducibility.

When you have completed the adjustment, press the **OK** button to accept your setting and then press the **MENU** button or **EXIT** button (WX6000 / SX6000).

- The adjustments you have made are stored as adjusted values for the input signals and image mode of the current projection.

Correcting the Image According to the Ambient Light

[Ambient light]

- HDMI Component
 Digital PC Analog PC

You can correct and more effectively project an image according to the ambient light on the screen.

MENU > [Image adjustment] > [Advanced adjustment] > [Ambient light]

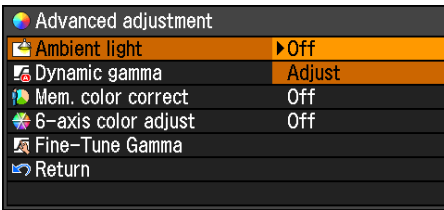

Off Projects an image with no correction.

Adjust You can specify the type and level (brightness) of the ambient light.

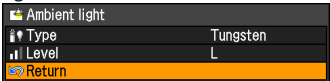

Type	Description
Tungsten	Select this if the ambient light source is a light bulb or bulb color fluorescent.
Fluorescent	Select this if the ambient light source is a day white fluorescent.
Fluorescent H	Select this if the ambient light source is a day-light color fluorescent.



- Level** L Select this if the ambient light is low.
- M Select this if the ambient light is normal.
- H Select this if the ambient light is high (bright).

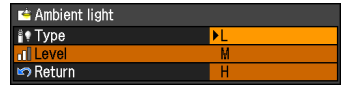

Examples of Ambient Light Level Settings

Level	Example Location
L	Projection room, sports bar, etc.
M	Photo studio, gallery
H	Conference room, lecture room

Press the **OK** button to accept your setting and then press the **MENU** button or **EXIT** button (WX6000 / SX6000).

- [Off] is the factory default.
- [Ambient light] can be set only in the following image modes.
 - HDMI (when [HDMI In] is [Auto]) or COMPONENT: Video, Cinema, Photo/sRGB
 - HDMI (when [HDMI In] is [Computer]), DIGITAL PC or ANALOG PC: Photo/sRGB

Selecting an Image Quality

Noise Reduction

[Noise reduction]

- HDMI Component
- Digital PC Analog PC

You can reduce image noise.

MENU > [Image adjustment] > [Advanced adjustment] > [Noise reduction]

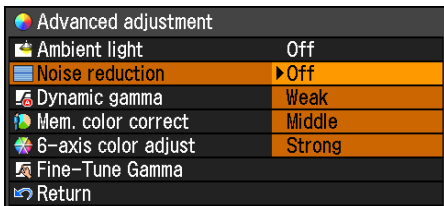

Off	Disables noise reduction.
Weak	Specifies the intensity of the noise reduction in three steps.
Middle	
Strong	

Press the **OK** button to accept your setting and then press the **MENU** button or **EXIT** button (WX6000 / SX6000).

- The factory default for HDMI (when [HDMI In] (P127) is set to [Auto]) is [Off] and when Component is used, it is set to [Weak].
- Noise reduction may produce motion artifacts when projecting fast-moving images.
- Select [Weak] for fast-moving images. Select [Strong] for slow-moving images.
- The adjustment you have made is stored as adjusted values for the input signals and image mode of the current projection.
- When [HDMI In] (P127) is [Computer], this setting is not displayed.

Dynamic Gamma

[Dynamic gamma]

- HDMI Component
- Digital PC Analog PC

You can adjust the gradation representation of light and dark portions of an image automatically.

MENU > [Image adjustment] > [Advanced adjustment] > [Dynamic gamma]

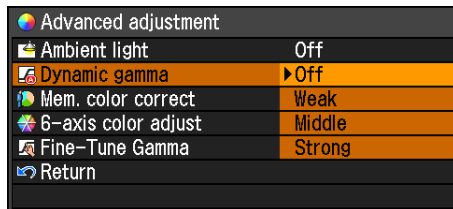

Off	Dynamic gamma is disabled.
Weak	Specifies the intensity of the dynamic gamma in three steps.
Middle	
Strong	

Press the **OK** button to accept your setting and then press the **MENU** button or **EXIT** button (WX6000 / SX6000).

- The factory default settings are [Off] when the connected equipment is a Computer (ANALOG PC, DIGITAL PC, HDMI (when [HDMI In] (P127) is [Computer])) and [Weak] when the connected equipment is AV equipment (COMPONENT, HDMI (when [HDMI In] (P127) is [Auto])).
- The adjustment you have made is stored as adjusted values for the input signals and image mode of the current projection.

Memory Color Correction

[Mem. color correct]

- HDMI
- Component
- Digital PC
- Analog PC

This function produces beautiful skin tones, blues, and other colors.

MENU > [Image adjustment] > [Advanced adjustment] > [Mem. color correct]

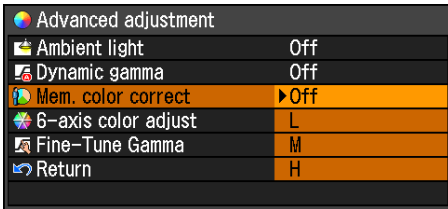

Off Disables the memory color correction function.

L
M
H Specifies the intensity of the memory color correction in three steps.

Press the **OK** button to accept your setting and then press the **MENU** button or **EXIT** button (WX6000 / SX6000).

- The factory default settings are as follows.
 - For HDMI (when [HDMI In] (P127) is set to [Computer]), Digital PC and Analog PC, when any image mode is used except [VividPhoto], the default setting is [Off]. When [VividPhoto] is used, the default setting is [M].
 - For HDMI (when [HDMI In] (P127) is set to [Auto]) and Component, the default setting is [L], regardless of the image mode.
- The adjustment you have made is stored as adjusted values for the input signals and image mode of the current projection.

6-axis Color Adjust (Detailed Color Adjustment)

[6-axis color adjust]

- HDMI
- Component
- Digital PC
- Analog PC

You can make fine adjustments to the image colors with RGB (red, green, blue) and CMY (cyan, magenta, yellow).

MENU > [Image adjustment] > [Advanced adjustment] > [6-axis color adjust]

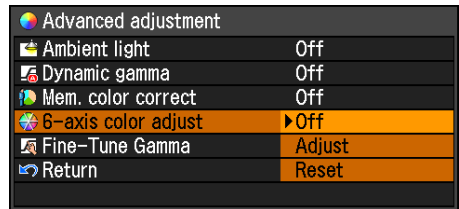

Off Disables 6-axis color adjustment. If you select [Adjust], the previous setting of 6-axis color adjustment becomes active again.

Adjust Enables 6-axis color adjustment.

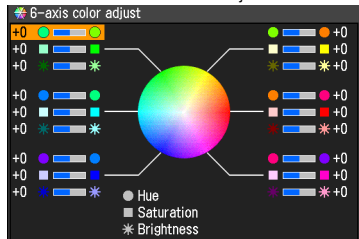

Use the **▲** / **▼** buttons to select [○ Hue], [□ Saturation], or [* Brightness], then adjust them with the **◀** / **▶** buttons.

When color adjustments are completed, press the **OK** button.

Reset Returns all adjustment values to zero.

When you have completed the adjustment, press the **OK** button to accept your setting and then press the **MENU** button or **EXIT** button (WX6000 / SX6000).

- [Off] is the factory default.
- The adjustments you have made are stored as adjusted values for the input signals and image mode of the current projection.

Selecting an Image Quality

Detailed Gamma Correction

[Fine-Tune Gamma]

- | | |
|----------------------------------|---------------------------------|
| <input type="radio"/> HDMI | <input type="radio"/> Component |
| <input type="radio"/> Digital PC | <input type="radio"/> Analog PC |

The four gamma curves (white, red, green, blue) can be adjusted. When the white curve is adjusted, the adjustment is also applied to the other three colors. This function allows more fine-tuned gamma correction. When either of these two functions is adjusted, the settings of the other are overwritten.

MENU > [Image adjustment] > [Advanced adjustment] > [Fine-Tune Gamma]

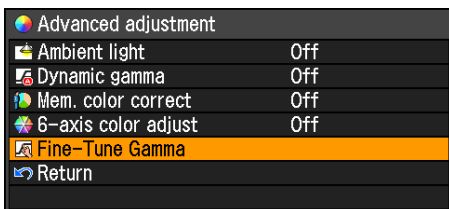

Select [Fine-Tune Gamma] then press the OK button. The following [Fine-Tune Gamma] screen for confirmation appears.

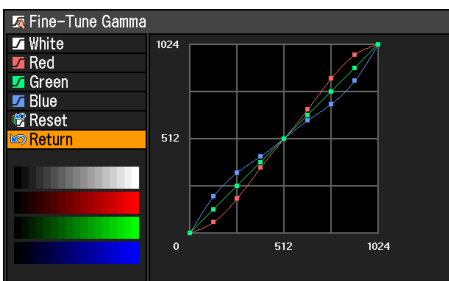

Use the [▲] / [▼] buttons to select the color, then press the OK button. Next use the [◀] / [▶] buttons to select a point on the gamma curve, and use the [▲] / [▼] buttons to adjust the position of the point. When you have completed the adjustment, press the OK button to accept your setting and then press the MENU button or EXIT button (WX6000 / SX6000).

- The adjustments you have made are stored as adjusted values for the input signals and image mode of the current projection.
- For details of gamma correction, refer to [page 113](#).

Reducing the Lamp Brightness

[Lamp mode]

- | | |
|----------------------------------|---------------------------------|
| <input type="radio"/> HDMI | <input type="radio"/> Component |
| <input type="radio"/> Digital PC | <input type="radio"/> Analog PC |

Reducing the lamp brightness reduces power consumption and cooling fan noise. For the WUX4000, you can also enable or disable this mode with the LAMP button on the remote control.

WUX4000

MENU > [Image adjustment] > [Lamp mode]

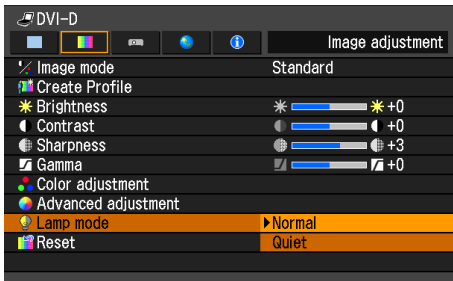

Normal Projects an image at the normal brightness level.

Quiet Reduces the lamp brightness and cooling fan noise.

Press the **OK** button to accept your setting and then press the **MENU** button.

- [Normal] is the factory default.
- The adjustment you have made is stored as adjusted values for the input signals and image mode of the current projection.

Resetting the Image Adjustment Settings

[Reset]

- | | |
|----------------------------------|---------------------------------|
| <input type="radio"/> HDMI | <input type="radio"/> Component |
| <input type="radio"/> Digital PC | <input type="radio"/> Analog PC |

You can reset the current image adjustment settings to the default settings. If reset is performed when user setting 1 - 5 is selected for [Image mode], the settings are returned to the settings that were saved in [User setting 1 - 5].

MENU > [Image adjustment] > [Reset]

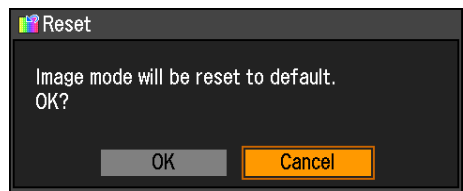

OK Resets the image adjustment settings.

Cancel Cancels resetting of the image adjustment settings.

- Only the setting for the combination of input signal and image mode for the current projection is reset.

Setting Various Functions

Selecting the Power Management Mode

[Power management mode]

- | | |
|----------------------------------|---------------------------------|
| <input type="radio"/> HDMI | <input type="radio"/> Component |
| <input type="radio"/> Digital PC | <input type="radio"/> Analog PC |

You can turn off the lamp or projector automatically in order to save power when the projector is not in use.

WUX5000 / WUX4000

MENU > [System settings] > [Power management mode]

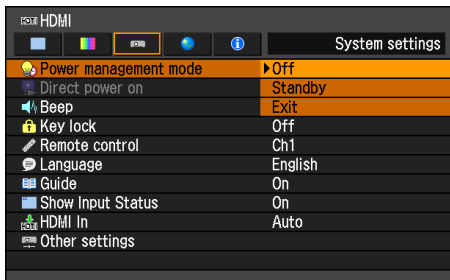

WX6000 / SX6000

MENU > [System settings] > [Power management mode]

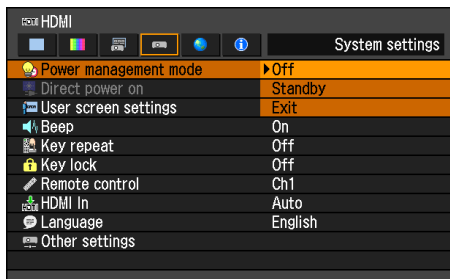

Off Disables the power management mode.

Standby If no input signal is received for 30 seconds, the countdown will be displayed and after 5 minutes, the lamp will turn off. If it receives an input signal or is operated during this period, it resumes projection.

Exit If no input signal is received for 30 seconds, it displays the countdown and turns off the projector after 5 minutes.

Press the **OK** button to accept your setting and then press the **MENU** button or **EXIT** button (WX6000 / SX6000).

- [Off] is the factory default.
- During standby mode, the [POWER ON] indicator and [STAND BY] indicator flash alternately.
- You cannot enable the [Direct power on] function (see the next item), if you select [Off].

Skip the POWER Button Operation

[Direct power on]

- | | |
|----------------------------------|---------------------------------|
| <input type="radio"/> HDMI | <input type="radio"/> Component |
| <input type="radio"/> Digital PC | <input type="radio"/> Analog PC |

You can turn on the projector by connecting the power cable without pressing the POWER button.

WUX5000 / WUX4000

MENU > [System settings] > [Direct power on]

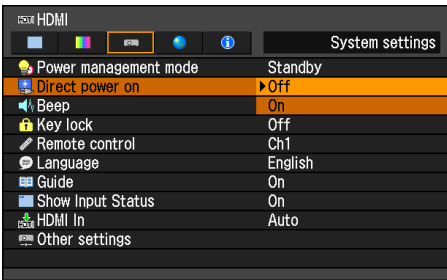

WX6000 / SX6000

MENU > [System settings] > [Direct power on]

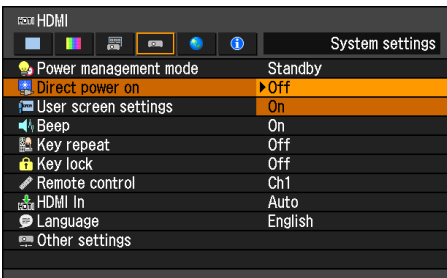

- | | |
|------------|---|
| Off | You need to press the POWER button to turn on the projector. |
| On | You can turn on the projector by connecting the power cable only. |

Press the **OK** button to accept your setting and then press the **MENU** button or **EXIT** button (WX6000 / SX6000).

- [Off] is the factory default.



- Before setting the direct power on to [On], be sure to set the [Power management mode] to [Standby] or [Exit].
- After turning off the projector, wait at least 5 minutes before turning it on again. It may shorten the lamp life if you turn on the projector immediately after turning it off.

Enabling / Disabling the Beep

[Beep]

- | | |
|----------------------------------|---------------------------------|
| <input type="radio"/> HDMI | <input type="radio"/> Component |
| <input type="radio"/> Digital PC | <input type="radio"/> Analog PC |

You can select whether a beep sounds or not when you operate the projector.

WUX5000 / WUX4000

MENU > [System settings] > [Beep]

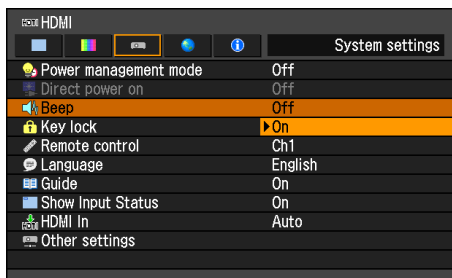

WX6000 / SX6000

MENU > [System settings] > [Beep]

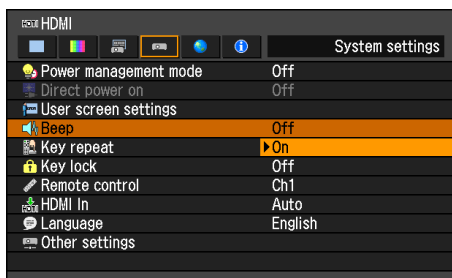

Off Disables the beep.

On Enables the beep.

Press the **OK** button to accept your setting and then press the **MENU** button or **EXIT** button (WX6000 / SX6000).

- [On] is the factory default.
- The beep will not sound if you mute the projector sound with the **MUTE** button on the remote control.

Key Repeat

[Key repeat]

- | | |
|----------------------------------|---------------------------------|
| <input type="radio"/> HDMI | <input type="radio"/> Component |
| <input type="radio"/> Digital PC | <input type="radio"/> Analog PC |

By pressing and holding the button on the projector or the remote control you can operate Key repeat in the same way as when the button is pressed repeatedly.

WX6000 / SX6000

MENU > [System settings] > [Key repeat]

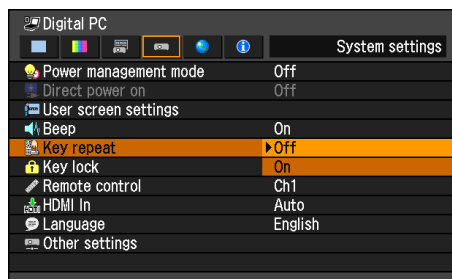

Off Key repeat is not enabled.

On Key repeat is enabled.

Press the **OK** button to accept your setting and then press the **MENU** button or **EXIT** button (WX6000 / SX6000).

- The factory default is [On].
- Even when Key repeat is [Off], Focus adjustment, Zoom Adjustment and Lens shift adjustment can still be used.

Prohibiting Operations

[Key lock]

- | | |
|----------------------------------|---------------------------------|
| <input type="radio"/> HDMI | <input type="radio"/> Component |
| <input type="radio"/> Digital PC | <input type="radio"/> Analog PC |

You can lock the projector to prevent its operation from either the main unit or remote control.

WUX5000 / WUX4000

MENU > [System settings] > [Key lock]

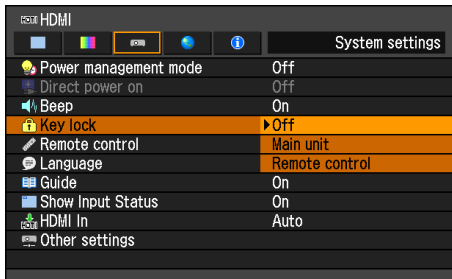

WX6000 / SX6000

MENU > [System settings] > [Key lock]

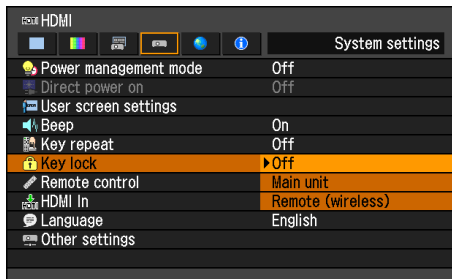

Off	Disables the key lock.
Main unit	Operation is not possible using the main unit. Use the remote control.
Remote control	Infrared remote control operations can no longer be performed. Use the main unit button. If using the WX6000 / SX6000, this can also be set by connecting a cable. (P30)

Press the **OK** button to accept your setting and then press the **MENU** button or **EXIT** button (WX6000 / SX6000).

- [Off] is the factory default.



The key lock function becomes effective from the moment the **OK** button is pressed after selecting [Main unit] or [Remote control]. Control via the item selected will then be disabled.

To Unlock Key Lock Function

Turn off the projector and unplug the power plug. Hold down the **OK** button on the main unit and connect the power plug. Keep holding down the **OK** button until a beep sounds. The key lock will be unlocked.

Setting Various Functions

Main Unit and Remote Control Channel Settings

[Remote control]

- | | |
|----------------------------------|---------------------------------|
| <input type="radio"/> HDMI | <input type="radio"/> Component |
| <input type="radio"/> Digital PC | <input type="radio"/> Analog PC |

When using multiple projectors at the same time (maximum 4), you can assign a different channel to each remote control so that each operates independently.

For the WX6000 / SX6000, set this when performing infrared operations.

Select the main unit channel.

WUX5000 / WUX4000

MENU > [System settings] > [Remote control]

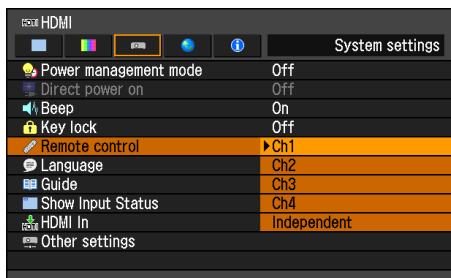

WX6000 / SX6000

MENU > [System settings] > [Remote control]

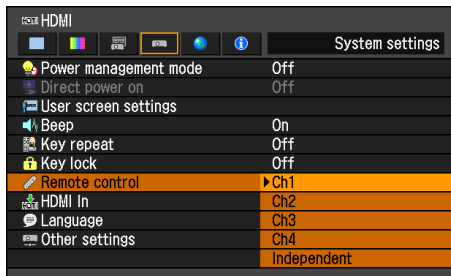

- Ch1 Select the remote control channel to use with this projector.
- Ch2
- Ch3
- Ch4

Independent Remote controls set to any channel can be used.

Press the **OK** button to accept your setting and then press the **MENU** button or **EXIT** button (WX6000 / SX6000).

- The factory default is [Independent] for both projector and remote control.
- After changing the channel on the menu, be sure to change the channel of the remote control too.
- If a cable is connected, it is not necessary to perform remote control channel setting.

Selecting a Channel on the Remote control

You can change the channel on the remote control as follows.

WUX5000 / WUX4000

Ch1 Press and hold the **OK** button and [**▲**] button at the same time for 3 seconds.

Ch2 Press and hold the **OK** button and [**▶**] button at the same time for 3 seconds.

Ch3 Press and hold the **OK** button and [**▼**] button at the same time for 3 seconds.

Ch4 Press and hold the **OK** button and [**◀**] button at the same time for 3 seconds.

Independent Press and hold the **OK** button and **MENU** button at the same time for 3 seconds.

WX6000 / SX6000

Ch1 Press and hold the **Ch** button and **1** button at the same time for 3 seconds.

Ch2 Press and hold the **Ch** button and **2** button at the same time for 3 seconds.

Ch3 Press and hold the **Ch** button and **3** button at the same time for 3 seconds.

Ch4 Press and hold the **Ch** button and **4** button at the same time for 3 seconds.

Independent Independent Press and hold the **Ch** button and **0** button at the same time for 3 seconds.

Selecting a Display Language

[Language]

- HDMI Component
 Digital PC Analog PC

You can select the language in which the menus are displayed.

MENU > [System settings] > [Language]

Language		
▶ English	Русский	Čeština
Deutsch	Nederlands	Dansk
Français	Suomi	إنجليزي
Italiano	Norsk	中文简体
Español	Türkçe	中文繁體
Português	Polski	한국어
Svenska	Magyar	日本語

Use the [▲] / [▼] / [▶] / [◀] buttons to select the menu language, then press the OK button.

English	English
German	Deutsch
French	Français
Italian	Italiano
Spanish	Español
Portuguese	Português
Swedish	Svenska
Russian	Русский
Dutch	Nederlands
Finnish	Suomi
Norwegian	Norsk
Turkish	Türkçe
Polish	Polski
Hungarian	Magyar
Czech	Čeština
Danish	Dansk
Arabic	إنجليزي
Chinese (Simplified)	中文简体
Chinese (Traditional)	中文繁體
Korean	한국어
Japanese	日本語

When the setting is completed, press the OK button to accept your setting and then press the MENU button or EXIT button (WX6000 / SX6000).

Setting Various Functions

Showing / Hiding the Guide Screen

[Guide]

- | | |
|----------------------------------|---------------------------------|
| <input type="radio"/> HDMI | <input type="radio"/> Component |
| <input type="radio"/> Digital PC | <input type="radio"/> Analog PC |

You can select whether to show or hide the guide screen which explains operations.

WUX5000 / WUX4000

MENU > [System settings] > [Guide]

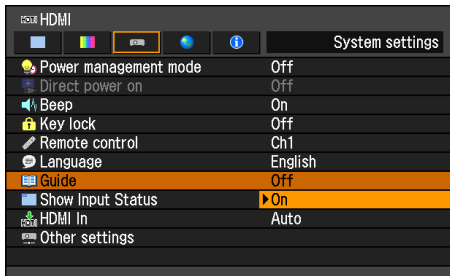

WX6000 / SX6000

MENU > [Install settings] > [On screen] >

[Guide]

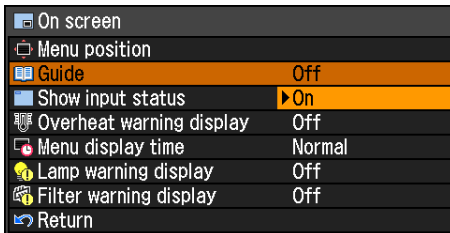

Off Hides the guide screen.

On Shows the guide screen.

Press the **OK** button to accept your setting and then press the **MENU** button or **EXIT** button (WX6000 / SX6000).

- [On] is the factory default.
- The guide screen is shown at the following times.
 - Power is turned off by pressing the **POWER** button. (P80)

- No input signal can be detected. (P58)
- An invalid button is pressed in the [BLANK], [FREEZE] or [D.ZOOM] mode. (P82, P84)
- When the positional lock (P139) is set to [On] (WX6000 / SX6000)

Showing / Hiding the Input Status

[Show Input Status]

- HDMI Component
 Digital PC Analog PC

You can select whether the signal status is displayed on the screen when there is no signal or when making signal settings.

WUX5000 / WUX4000

MENU > [System settings] > [Show Input Status]

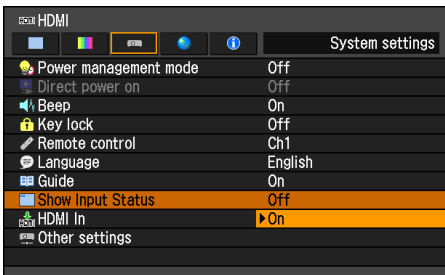

WX6000 / SX6000

MENU > [Install settings] > [On screen] > [Show input status]

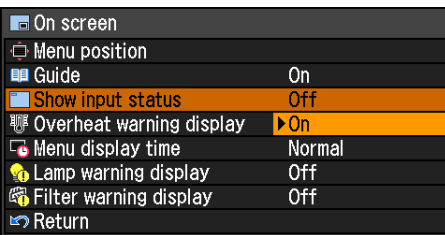

Off The input status is not displayed.

On The input status is displayed.

Press the **OK** button to accept your setting and then press the **MENU** button or **EXIT** button (WX6000 / SX6000).

- [On] is the factory default.

Selecting the HDMI Input

[HDMI In]

- HDMI Component
 Digital PC Analog PC

Set the type of equipment which is connected to the HDMI port.

WUX5000 / WUX4000

MENU > [System settings] > [HDMI In]

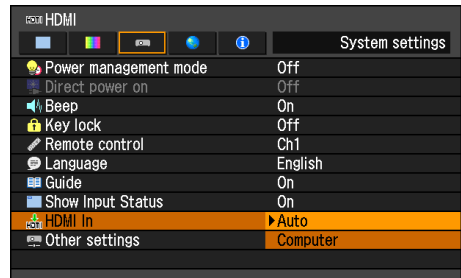

WX6000 / SX6000

MENU > [System settings] > [HDMI In]

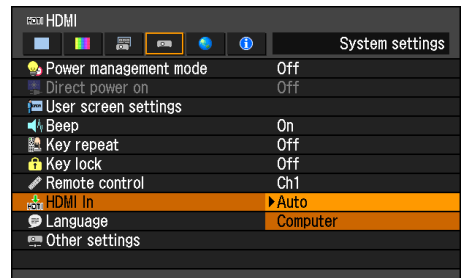

Auto Select when AV equipment will be connected. Image processing, menu displays, and other elements are adjusted for video equipment.

Computer Select when a **computer** will be connected. Image processing, menu displays, and other elements are adjusted for a **computer**.

Press the **OK** button to accept your setting and then press the **MENU** button or **EXIT** button (WX6000 / SX6000).

Setting Various Functions

Setting a Password

[Password settings]

- | | |
|----------------------------------|---------------------------------|
| <input type="radio"/> HDMI | <input type="radio"/> Component |
| <input type="radio"/> Digital PC | <input type="radio"/> Analog PC |

Disables the projector unless the correct password is entered.

WUX5000 / WUX4000

MENU > [System settings] > [Other settings] > [Password settings]

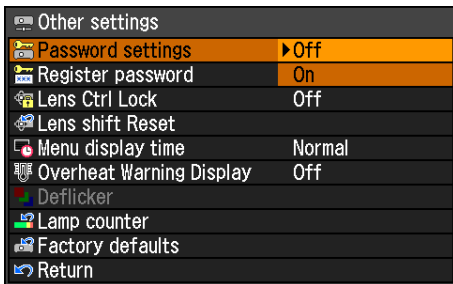

WX6000 / SX6000

MENU > [System settings] > [Other settings] > [Password settings]

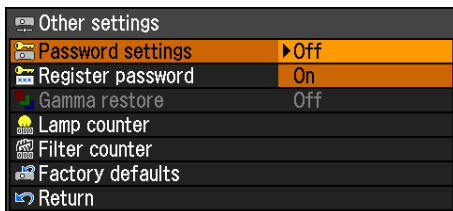

- | | |
|-----|--|
| Off | The projector can be used even if no password is entered. |
| On | The projector cannot be used unless you enter your password. |

Press the **OK** button to accept your setting and then press the **MENU** button or **EXIT** button (WX6000 / SX6000).

- [Off] is the factory default.
- You cannot set [On] unless you have completed [Register password].

Once you set a password, the password entry screen appears at power-on.

Enter a 4 digit password.

For the WUX5000 / WUX4000, the password can be entered using the [▼] / [▲] / [◀] / [▶] buttons. For the WX6000 /

SX6000, the password can be entered using a combination of the numerical buttons and the [▼] / [▲] / [◀] / [▶] buttons. [▲] / [1], [▶] / [2], [▼] / [3], and [◀] / [4] have the same function.

If the password is valid, the projection starts. If you enter a wrong password three times, the power will be turned off.

- The power is also turned off if no password is input for 3 minutes.

To Cancel the Password

Turn off the projector and unplug the power plug.

Hold down the **MENU** button on the side control and connect the power plug. Make sure to keep holding down the **MENU** button until a beep sounds. When the beep sounds, the password is canceled. (The entered password is also reset.)

To forcibly cancel the password from the remote control, in standby state press the **MENU** button 3 times, then press the **POWER** button.

Registering a Password

[Register password]

- | | |
|----------------------------------|---------------------------------|
| <input type="radio"/> HDMI | <input type="radio"/> Component |
| <input type="radio"/> Digital PC | <input type="radio"/> Analog PC |

You can register a password for starting projection.

WUX5000 / WUX4000

MENU > [System settings] > [Other settings] > [Register password]

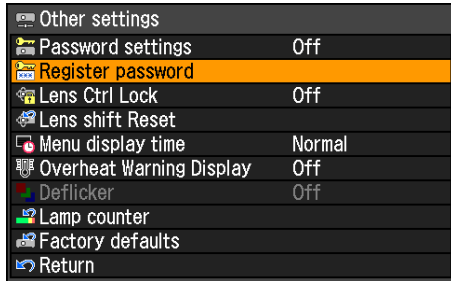

WX6000 / SX6000

MENU > [System settings] > [Other settings] > [Register password]

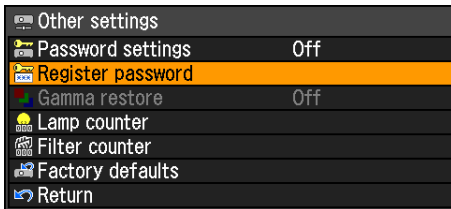

Press the OK button after selecting [Register password], and the following screen for registering a password appears.

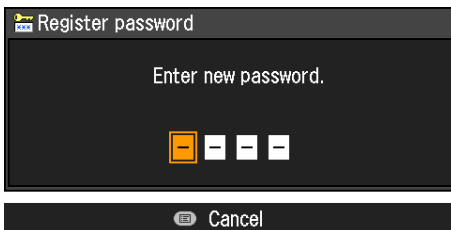

Enter a 4 digit password.

For the WUX5000 / WUX4000, the password can be entered using the [▼] / [▲] / [◀] / [▶] buttons. For the WX6000 / SX6000, the password can be entered using a combination of the numerical buttons and the [▼] / [▲] / [◀] / [▶] buttons. [▲] / [1], [▶] / [2], [▼] / [3], and [◀] / [4] have the same function.

The 4-digit password is entered from the left to right digits. When the final digit is entered, the password is automatically registered.

- Press the MENU button to abort the registration.

Prohibiting Operation of the Lens

[Lens Ctrl Lock]

- | | |
|----------------------------------|---------------------------------|
| <input type="radio"/> HDMI | <input type="radio"/> Component |
| <input type="radio"/> Digital PC | <input type="radio"/> Analog PC |

You can lock lens-related button operations.

WUX5000 / WUX4000

MENU > [System settings] > [Other settings] > [Lens Ctrl Lock]

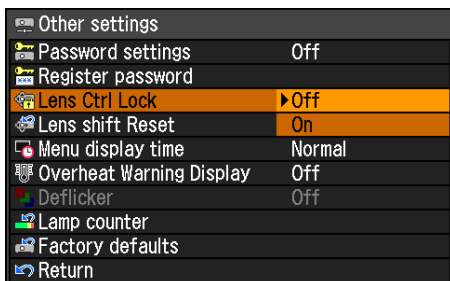

Off Focus, zoom, lens shift, and other lens-related operations are permitted.

On Focus, zoom, lens shift, and other lens-related operations are locked.

Press the **OK** button to accept your setting and then press the **MENU** button.

- [Off] is the factory default.

Lens Shift Reset

[Lens shift Reset]

- HDMI Component
- Digital PC Analog PC

Resets the lens shift (P74) setting to the standard position.

WUX5000 / WUX4000

MENU > [System settings] > [Other settings] > [Lens shift Reset]

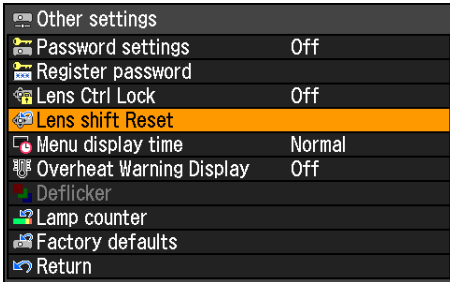

WX6000 / SX6000

MENU > [Install settings] > [Lens shift Reset]

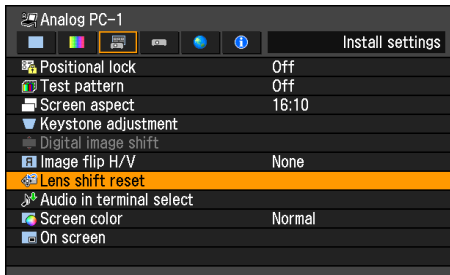

Select [Lens shift Reset] and press the **OK** button. The following screen for confirmation appears.

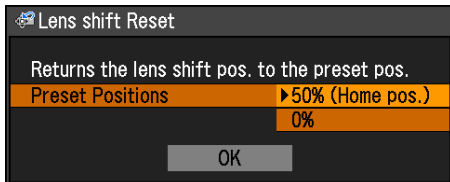

Use the **[▲]** / **[▼]** buttons to select the standard position, and then select **OK**.

- The standard position varies depending on the type of lens unit used. For details, refer to [page 75](#).
- The position which was adjusted by lens shift does not change when the power is turned off.

Setting Various Functions

Extending the Menu Display Time

[Menu display time]

- | | |
|----------------------------------|---------------------------------|
| <input type="radio"/> HDMI | <input type="radio"/> Component |
| <input type="radio"/> Digital PC | <input type="radio"/> Analog PC |

The setting for the menu display time can be extended from the normal 10 or 30 seconds to 3 minutes. For the WUX5000 / WUX4000, if [Extended] is set, when pushing and holding a button on the projector or remote control, the same key repeat function will be enabled as when pressing a button repeatedly.

WUX5000 / WUX4000

MENU > [System settings] > [Other settings] > [Menu display time]

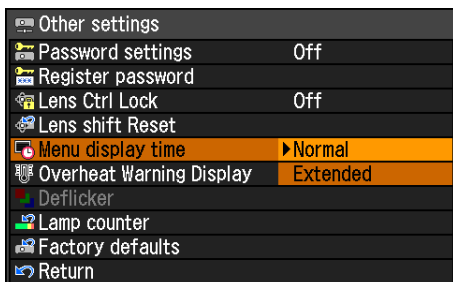

WX6000 / SX6000

MENU > [Install settings] > [On screen] > [Menu display time]

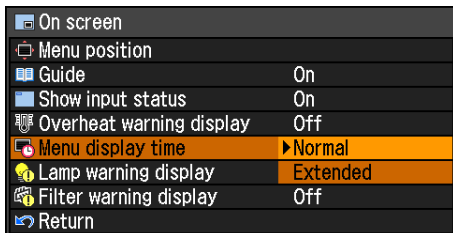

Normal The menu is displayed for 10 or 30 seconds.

Extended The menu is displayed for 3 minutes.

Press the OK button to accept your setting and then press the MENU button or EXIT button (WX6000 / SX6000).

- [Normal] is the factory default.
- The following display and operation are also changed.

Item	[Normal]	[Extended]
The display time of the following screens -MENU screen -Input (P60) -Zoom adjustment (P71) -Focus adjustment (P73) -Keystone adjustment (P76) -Keystone reset (P77) -D.image shift adjustment (P67, P68) -D.image shift reset (P69) -Aspect (P70) -Image mode (P78) -Volume adjustment (P83) -Lamp mode (P119) *1 -Lens shift (P74) -Lens shift reset (P131)	10 / 30 seconds	3 minutes
Press-and-hold operation of pointer buttons other than for [Zoom adjustment], [Focus adjustment], and [Lens shift] Press-and-hold operation of VOL button Press-and-hold operation of the D.ZOOM button	Enabled	Disabled
Key repeat *2	[On]	[Off]

*1 WUX4000

*2 WX6000 / SX6000

Showing / Hiding the High Temperature Warning Icon

[Overheat Warning Display]

- | | |
|----------------------------------|---------------------------------|
| <input type="radio"/> HDMI | <input type="radio"/> Component |
| <input type="radio"/> Digital PC | <input type="radio"/> Analog PC |

You can select whether or not to display the [High temperature warning] icon when the temperature inside the projector has increased and is approaching the overheat temperature.

WUX5000 / WUX4000

MENU > [System settings] > [Other settings] > [Overheat Warning Display]

Other settings	
Password settings	Off
Register password	
Lens Ctrl Lock	Off
Lens shift Reset	
Menu display time	Normal
Overheat Warning Display	Off
Deflicker	On
Lamp counter	
Factory defaults	
Return	

WX6000 / SX6000

MENU > [Install settings] > [On screen] > [Overheat warning display]

On screen	
Menu position	
Guide	On
Show input status	On
Overheat warning display	Off
Menu display time	On
Lamp warning display	Off
Filter warning display	Off
Return	

Off	The [High temperature warning] icon is not displayed.
On	The [High temperature warning] icon is displayed.

Press the **OK** button to accept your setting and then press the **MENU** button or **EXIT** button (WX6000 / SX6000).
When [On] is set, the [High temperature warning] icon shown below will be dis-

played when the temperature inside the projector is abnormally high.

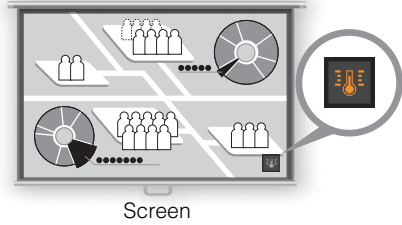

- [Off] is the factory default.

Setting Various Functions

Reducing Flickering

[Deflicker]

- | | |
|----------------------------------|---------------------------------|
| <input type="radio"/> HDMI | <input type="radio"/> Component |
| <input type="radio"/> Digital PC | <input type="radio"/> Analog PC |

This function adjusts the image display in order to reduce flickering in the projected image.

WUX5000 / WUX4000

MENU > [System settings] > [Other settings] > [Deflicker]

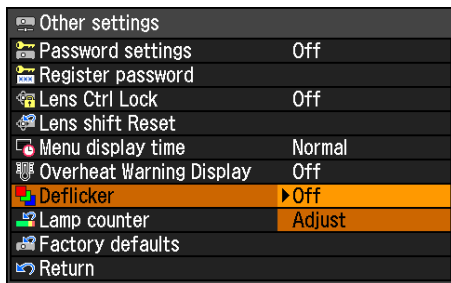

Off Deflicker adjustment is not performed.

Adjust Select [Deflicker] to adjust. The following screen appears.

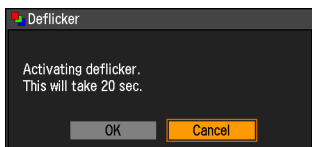

OK Deflicker is performed.

Cancel Deflicker is not performed.

- When deflicker is performed, the image adjustment screen is projected for approximately 20 seconds.
- To cancel deflicker, press the **POWER** button.



- Deflicker can only be used when the lamp has been on for approximately 30 minutes or longer.
- Be aware that deflicker may be unable to eliminate flickering in some cases.

Gamma Restore

[Gamma restore]

- | | |
|----------------------------------|---------------------------------|
| <input type="radio"/> HDMI | <input type="radio"/> Component |
| <input type="radio"/> Digital PC | <input type="radio"/> Analog PC |

The gamma characteristic of the LCD panel inside the projector can be corrected.

WX6000 / SX6000

MENU > [System settings] > [Other settings] > [Gamma restore]

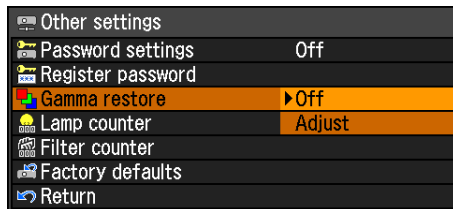

Off Returns to the factory default without performing Gamma restore.

Adjust Performs Gamma restore and applies the result.

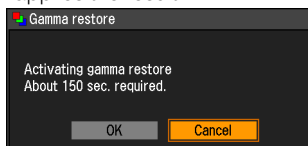

OK Gamma Restore is performed.

Cancel Gamma Restore is not performed.

- If Gamma restore is performed, the projected image will be adjusted for a period of approximately 150 seconds.
- To stop Gamma restore, press the **POWER** button or the **EXIT** button (WX6000 / SX6000).



- Gamma restore can be performed once approximately 30 minutes have elapsed after the lamp flashes.
- Be aware that if Gamma restore adjustment is performed, the color quality of the projected image may be changed.

Lamp Warning Display

[Lamp warning display]

- HDMI Component
 Digital PC Analog PC

A message that advises you to change the lamp can be set to display when the lamp has been used for the specified period of time.

WX6000 / SX6000

MENU > [Install settings] > [On screen] > [Lamp warning display]

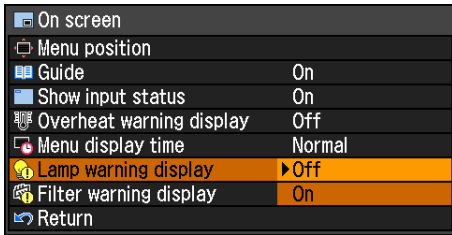

Off	The lamp warning display is not displayed.
On	The prepare lamp message and the lamp warning display are displayed.

Press the **OK** button to accept your setting and then press the **MENU** button or **EXIT** button (WX6000 / SX6000).

- The factory default is [On].
- Regardless of the [Lamp warning display] setting, when the lamp replacement time has been reached, the LAMP indicator on the projector will flash.

Resetting the Lamp Counter

[Lamp counter]

- HDMI Component
 Digital PC Analog PC

You can reset the lamp counter that indicates the time for lamp replacement.



Caution

Do not reset the lamp counter except when you have replaced the lamp. Otherwise, the lamp counter cannot indicate the correct timing for replacing the lamp.

For details of lamp replacement, refer to [page 195](#).

WUX5000 / WUX4000

MENU > [System settings] > [Other settings] > [Lamp counter]

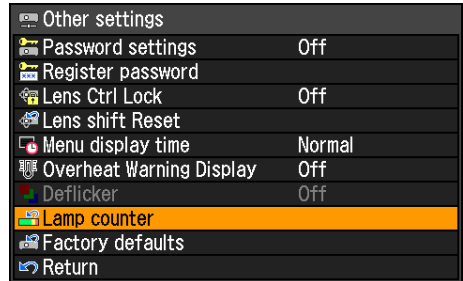

WX6000 / SX6000

MENU > [System settings] > [Other settings] > [Lamp counter]

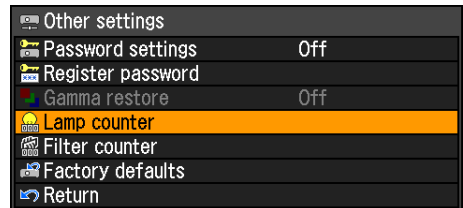

Setting Various Functions

Select [Lamp counter] and press the **OK** button to display the lamp counter.

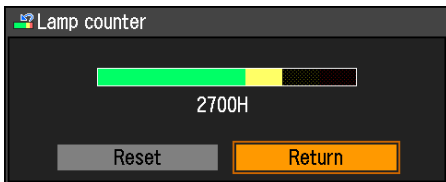

Select [Reset] and press the **OK** button.

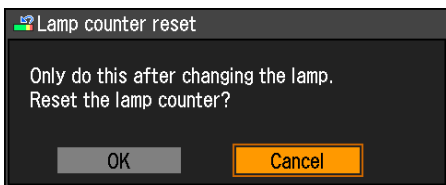

Select [OK] on the screen for confirmation and press the **OK** button to reset the lamp counter.

Press the **MENU** button or **EXIT** button (WX6000 / SX6000).

■ About the Display of the Lamp Counter

The lamp counter displays the hours of use of the lamp in the following way.

Less than 2,700 hours

Displayed as a **green** bar.

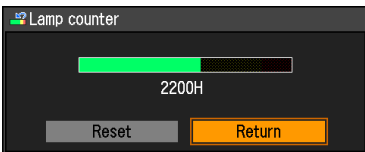

2,700 hours to less than 3,000 hours

Displayed as a **green and yellow** bar.

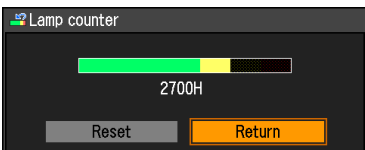

When the lamp hours are 2,700 hours to less than 3,000 hours, the message "Obtain a new lamp." appears when power is turned on.



Over 3,000 hours

Displayed as a **green, yellow and red** bar.

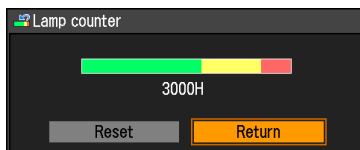

The message "Replace with the new lamp." appears when power is turned on.

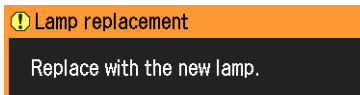

Filter Warning Display

[Filter warning display]

- HDMI Component
 Digital PC Analog PC

A message advising you to perform cleaning can be set to display when the filter needs cleaning.

WX6000 / SX6000

MENU > [Install settings] > [On screen] > [Filter warning display]

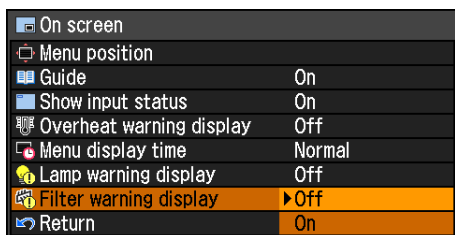

Off The filter warning display is not displayed.

On The filter warning display is displayed.

Press the **OK** button to accept your setting and then press the **MENU** button or **EXIT** button (WX6000 / SX6000).

- The factory default is [On].

Resetting the Air Filter Counter

[Filter counter]

- HDMI Component
 Digital PC Analog PC

This resets the counter which reminds you of the time for cleaning and replacing the air filter.

 For details about how to replace or clean the filter, refer to [page 193](#).

WX6000 / SX6000

MENU > [System settings] > [Other settings] > [Filter counter]

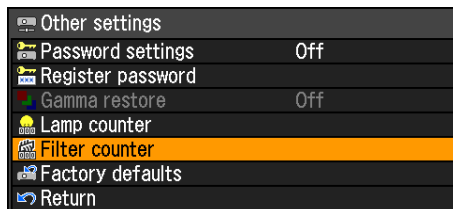

If the **OK** button is pressed on [Filter counter], the air filter counter is displayed.

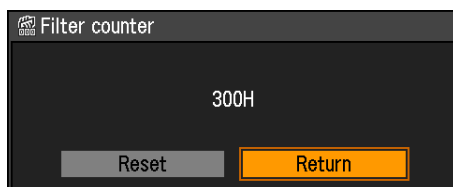

Select [Reset] and press the **OK** button.

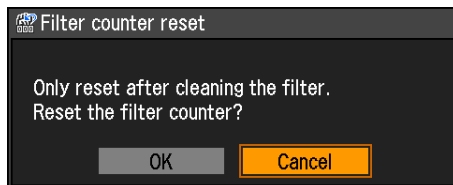

[OK] is selected on the confirmation screen and the **OK** button is pressed, the air filter counter is reset. Press the **MENU** button or **EXIT** button (WX6000 / SX6000).

Displaying Test Pattern

[Test pattern]

- | | |
|----------------------------------|---------------------------------|
| <input type="radio"/> HDMI | <input type="radio"/> Component |
| <input type="radio"/> Digital PC | <input type="radio"/> Analog PC |

A test pattern for checking the resolution and color when installing the projector can be displayed.

WX6000 / SX6000

MENU > [Install settings] > [Test pattern]

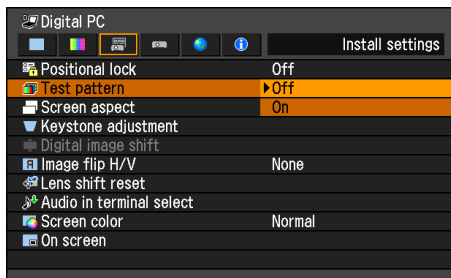

Off The test pattern is not displayed.

On The test pattern is displayed.

Press the **OK** button to accept your setting and then press the **MENU** button or **EXIT** button (WX6000 / SX6000).

- The factory default is [Off].
- While the test pattern is displayed, you can use the **[▲]** / **[▼]** buttons to change to a different test pattern. Also, if a test pattern has option settings, you can change the settings using the **[◀]** / **[▶]** button. (P217)
- The test pattern can also be displayed or turned off by pressing the **TEST PATTERN** button on the remote control.



The following functions in the [Image adjustment] tab are not applied to the test pattern.

- Brightness adjustment function (P111)
- Contrast adjustment function (P112)
- Sharpness adjustment function (P113)
- Color level adjustment function (P114)
- Color balance adjustment function (P114)

Selecting Audio In Terminal

[Audio in terminal select]

- HDMI Component
 Digital PC Analog PC

You can select the audio in terminal that is used for each input signal (HDMI, Digital PC, Analog PC-1, Analog PC-2, Component).

WX6000 / SX6000

MENU > [Install settings] > [Audio in terminal select]

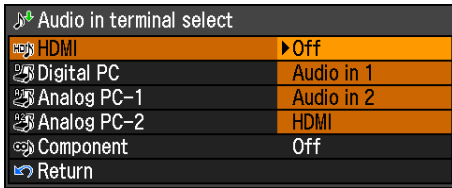

Off	No audio is output.
Audio in 1	Outputs the audio signal that is inputted in Audio in terminal 1.
Audio in 2	Outputs the audio signal that is inputted in Audio in terminal 2.
HDMI	Outputs the HDMI audio signal. (Only for HDMI)

Press the **OK** button to accept your setting and then press the **MENU** button or **EXIT** button (WX6000 / SX6000).

- The factory default is as follows.
 HDMI: HDMI
 Digital PC: Audio in 2
 Analog PC-1: Audio in 1
 Analog PC-2: Audio in 2
 Component: Audio in 1

Locking Installation Related Functions

[Positional lock]

- HDMI Component
 Digital PC Analog PC

Operation of installation related functions can be prohibited.

WX6000 / SX6000

MENU > [Install settings] > [Positional lock]

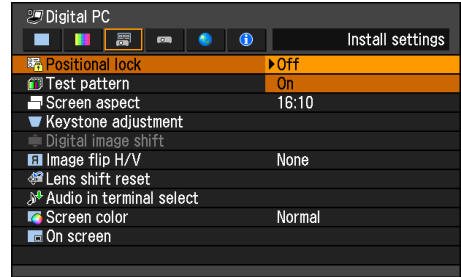

Off	The positional lock is not used.
On	Installation related functions cannot be used.

Press the **OK** button to accept your setting and then press the **MENU** button or **EXIT** button (WX6000 / SX6000).

- The factory default is [Off].
- The positional lock can be applied to Test pattern display, Screen aspect settings, Keystone adjustment, Digital image shift adjustment, Image flip H/V, Focus adjustment, Zoom adjustment, Lens shift adjustment and Lens shift reset.

Setting Various Functions

Resetting to the Default Setting

[Factory defaults]

- | | |
|----------------------------------|---------------------------------|
| <input type="radio"/> HDMI | <input type="radio"/> Component |
| <input type="radio"/> Digital PC | <input type="radio"/> Analog PC |

You can reset the menu item settings and restore the system settings to the factory defaults.

WUX5000 / WUX4000

MENU > [System settings] > [Other settings] > [Factory defaults]

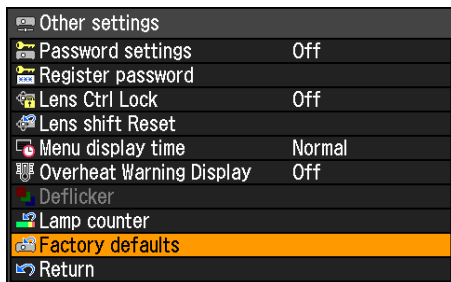

WX6000 / SX6000

MENU > [System settings] > [Other settings] > [Factory defaults]

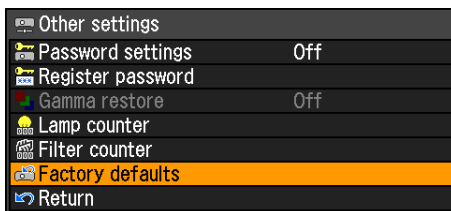

Select [Factory defaults] and press the **OK** button. The following screen for confirmation appears.

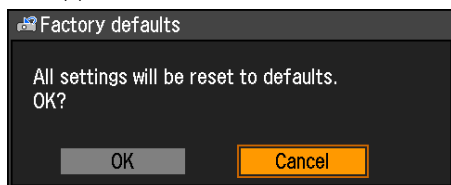

- | | |
|--------|------------------------------------|
| OK | Settings are reset to default. |
| Cancel | Settings are not reset to default. |

- This function does not reset the values for [Lamp counter], [Language], [Remote control], [Input signal], [Network Setting], [Filter counter], [Focus position], [Zoom position], and [Lens shift position].
- For factory defaults settings, refer to [pages 232 – 238](#).
- The contents of the user memory return to the conditions at the time it was saved. (P110)

Checking Projector Information

[Information]

- HDMI
- Component
- Digital PC
- Analog PC

You can check information about the signal types of the images projected and other information.

WUX5000 / WUX4000

MENU > [Information]



WX6000 / SX6000

MENU > [Information]

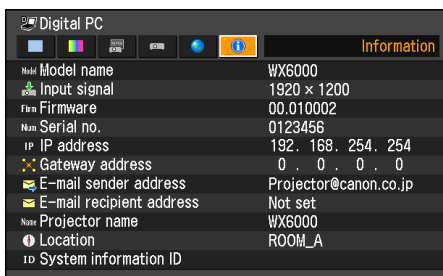

Information shown

Item	Meaning
Model name	WUX5000 / WUX4000 / WX6000 / SX6000
Input signal	Details of the input signal currently selected Information such as the signal type, signal resolution, and frequency is displayed.
Firmware	Current firmware version
Serial No.	Serial number unique to this projector
IP address*	IP address of the projector (P175)
Gateway address*	IP address of the gateway device (P175)
E-mail sender address*	Sender e-mail address used for sending error mails (P183)
E-mail recipient address*	Displays [Already set] or [Not set] to show whether a recipient e-mail address has been set for receiving error mails. (P183)
Projector name*	Name which identifies this projector on the network
Location*	Location where the projector is installed
System information ID	System information. Normally this is not displayed.

* Not displayed when network functions are [Off].

MULTIMEDIA PROJECTOR

WUX5000

WUX4000

WX6000

SX6000

Installation Manual (Installation and Maintenance)

Do not attempt installation yourself. Be sure to request installation from a qualified technician or contact the Canon Customer Support Center.



Installation

Table of Contents

Safety Instructions

Before Use

Projecting an Image

Useful Functions Available
During a Presentation

Setting Functions from Menus

Installation

Connecting to a Network

Maintenance

Appendix

Index

User's Manual

Installation Manual

Appendix

Installation Precautions

Precautions When Carrying the Projector

Prepare the projector as described below before carrying it.



Caution

- Disconnect the cables connected to the projector. Carrying the projector with the cables attached may cause an accident.
- Retract the adjustable feet.
- When the projector is transported after the lens unit is installed, be sure that you do not grasp the lens while transporting it. Doing so may damage the projector.

Installation Precautions

Be sure to read on [page 12 – 24](#). Pay attention to the following when installing the projector.



Caution

- Do not strike the projector or subject it to impact. Doing so may cause a malfunction.
- Do not install the projector so that it is inclined or standing vertically. The projector may tip over, causing damage.
- Do not block the cooling fan intake or exhaust vent. If the intake or exhaust vent is blocked, heat may accumulate inside the projector, causing a malfunction.

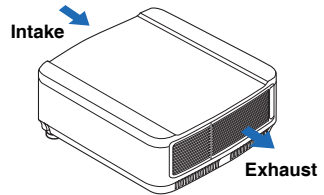

Precautions When Carrying and Transporting the Projector



Caution

- Do not reuse any packaging or shock-absorbent materials that were supplied with the projector at the time of purchase for transporting or shipping the projector. Protection of the projector cannot be guaranteed if used packaging or shock-absorbent materials are reused. Fragments from shock-absorbent material may also enter the interior of the projector which could cause a malfunction.
- If transportation is necessary, the lens unit should be removed before transporting the projector. If the projector is subjected to excessive impacts during transportation, the lens unit may be damaged. Removal and installation of the lens unit should not be performed by the user. Be sure to have the procedure performed by a qualified technician or contact the Canon Customer Support Center.

■ Do Not Use in the Following Environments

- Do not install the projector in a humid or dusty location or a position where there is a lot of oily smoke or cigarette smoke. Optical parts such as the lens and mirror may be stained, resulting in poor picture quality.
- Do not install close to high-voltage power lines or power sources. The projector may not operate correctly.
- Do not use the projector on a soft surface such as a carpet or sponge mat. Heat may accumulate inside the projector, causing a malfunction.
- Do not use the projector in a location that is subject to very high temperatures, very low temperatures, or high levels of humidity. Doing so may cause a malfunction. The temperature and humidity ranges for operation and the temperature range for storage are shown below.

Operating temperature	Operating humidity	Storage temperature
5°C to 35°C	Up to 85%	-10°C to 60°C

■ Do Not Touch the Lens with Bare Hands

Do not touch the lens with bare hands. Doing so may adversely affect picture quality.

■ Install at a Sufficient Distance from Walls and Other Obstructions



Caution

If the air intake or exhaust vent is blocked, heat will accumulate inside the projector, possibly resulting in a shortened projector life-time or a malfunction. Do not install in a closet, on a bookshelf, or other narrow location with poor ventilation. Install in a well ventilated location. (Install with a minimum of 50 cm (1.6') clearance on the top and sides, and 50 cm (1.6') to the rear.)

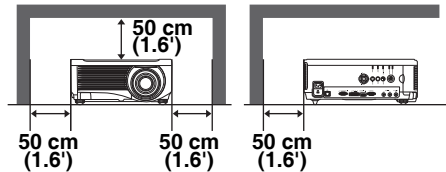
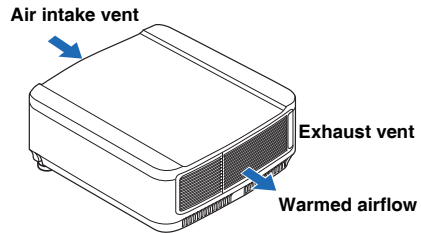

■ Be Careful of Condensation

If the temperature of the room rises suddenly, moisture in the air may condense on the projector lens and mirror, causing the image to become blurred. Wait until condensation evaporates and a normal picture is shown.

■ When Using the Projector at Altitudes Greater than 2,300 m

Contact the Canon Customer Support Center if you intend to use this projector at altitudes of 2,300 m or higher.

Installation Precautions

■ When using mounted on the ceiling

When the projector is used mounted on the ceiling or installed in a high location, it is necessary to periodically clean the air intake and exhaust vents, and the area around the air filter. If dust accumulates in the intake or exhaust vents, cooling performance will deteriorate, causing the internal temperature to rise and possibly resulting in a malfunction or fire. Use a vacuum cleaner or similar means to remove dust from the intake vent and exhaust vent.

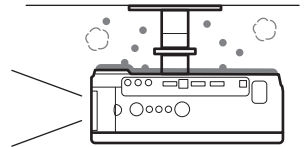

■ Install facing in the correct direction



This projector can be installed in directions of 360° *1 as shown in the illustration below. However, if projecting upward (A) or downward (B), the life span of the lamp may be shortened, and it is necessary to change the settings of the projector. If using the projector for upward or downward projection, please contact the Canon Customer Support Center.

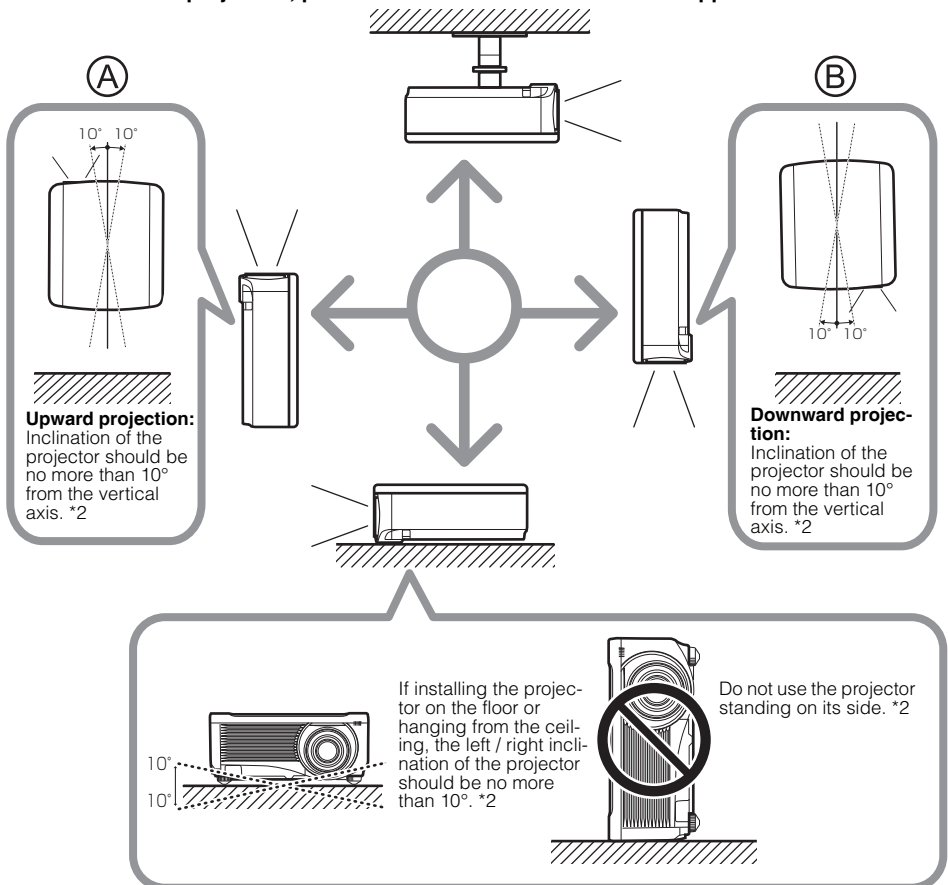

*1 There are no options for installing the projector other than the ceiling attachment. (P33, P150, P231)

*2 This may damage the lamp.

Installation Procedure

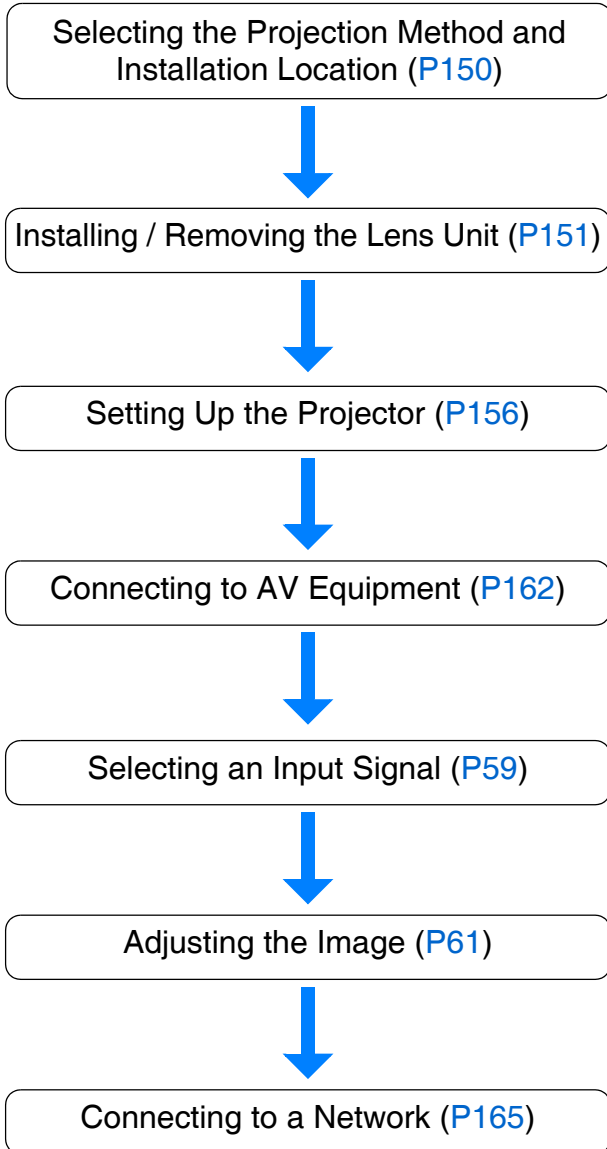

Selecting the Projection Method and Installation Location

■ Ceiling Mounting or Rear Projection

You can mount the projector on the ceiling (ceiling mounting) with it turned upside down or place it behind the screen (rear projection) if you use a translucent screen.

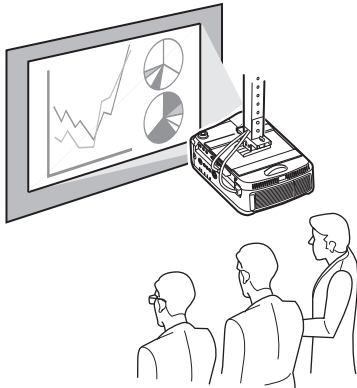

Ceiling Mounting

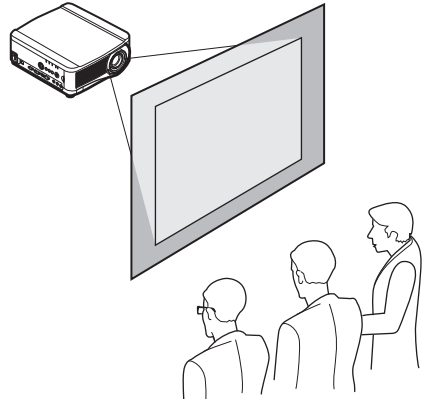

Rear Projection

Make sure to use the optional ceiling attachment. For the ceiling attachment, refer to [page 231](#).

■ Adjusting the projection position when installed on the floor

To adjust the projection position when the projector is installed on the floor, use the lens shift function ([P74](#) and [P160](#)) to adjust up / down / left / right. You can also use the adjustable feet to incline the projector upward by up to 6°. For information about the relationship between screen size and projection distance, refer to [page 156](#).

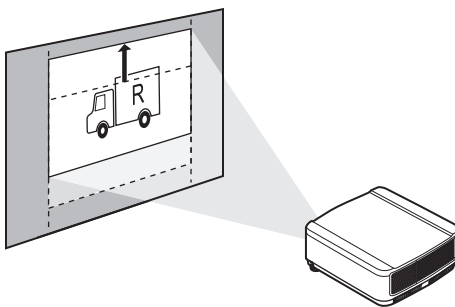

Lens shift

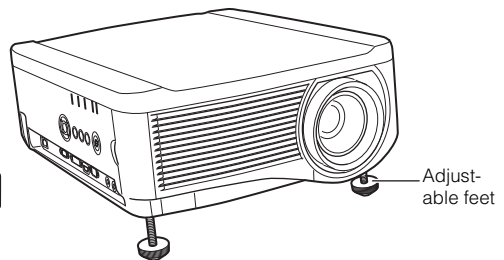

When the projector is inclined upwards, the projected image will be distorted into a trapezoid shape. This can be corrected by using the keystone correction. ([P76](#))

Installing / Removing the Lens Unit

■ Installing the Lens Unit



Before installing or removing the lens unit, be sure to disconnect the power plug or connector. Failure to do so may result in fire, electric shock, or injury.



- Before replacing the lens unit, make sure to turn off the projector, wait at least 1 hour to allow the projector to cool thoroughly. Failure to do so may result in burns or other injuries.
- Do not touch the lens when the lens is moving (the lens is shifting) to adjust the projected image after installation. There is the risk of injury.
- When hanging the projector from a ceiling, put the projector down on the floor or a workbench before attaching or replacing the lens unit. Failure to do so could result in parts falling off the projector and may cause an accident or personal injury.



Caution

- Do not attempt to install or remove the lens unit yourself. Be sure to request this service from a qualified technician or contact the Canon Customer Support Center.
- When installing and removing the lens unit, be sure not to touch the surface of the lens with your hands or scratch it.
- Do not apply force to parts (e.g. lead wires) that are connected to the lens unit or lens motor. Doing so may cause a malfunction.
- Do not replace the lens unit in a dusty location. If any dust or dirt enters the projector, this may adversely affect picture quality.
- For details about which devices the projector is compatible with, contact the Canon Customer Support Center.

- 1** Use a Phillips-head screwdriver and loosen the lamp cover screw, then open the lamp cover.

The lamp cover screw is attached to the lamp cover and designed to prevent it from falling off.

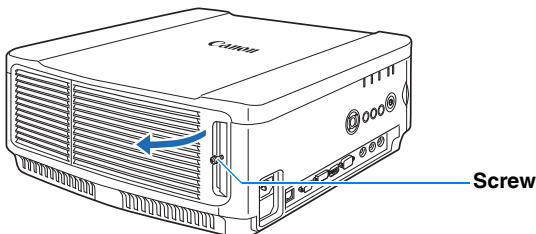

Installing / Removing the Lens Unit

- 2** Loosen the cosmetic panel screw, then slide the cosmetic panel toward the rear to remove it.
The cosmetic panel screw is attached to the cosmetic panel and designed to prevent it from falling off.

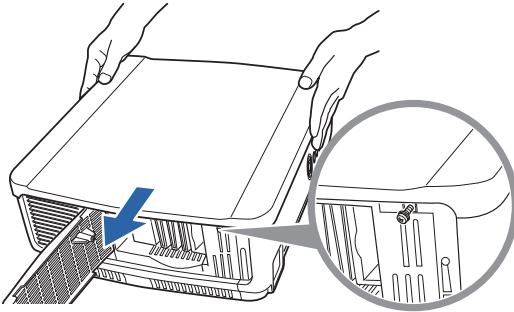

- 3** In order to prevent damage, close the lamp cover and temporarily fasten the screw.

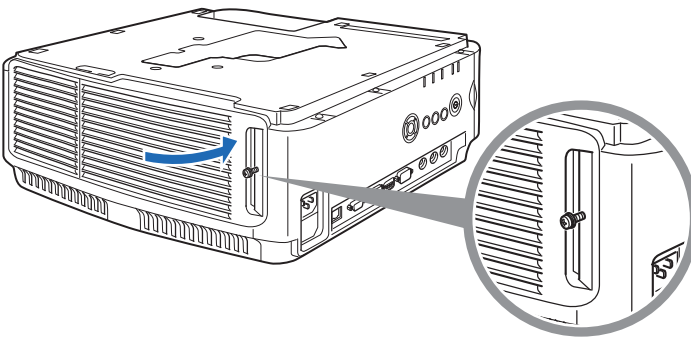

- 4** Remove the sleeve screws (2 on top and 2 on bottom).
After the 2 screws on top are removed, turn the projector upside down on a flat desk or similar location and remove the 2 screws from the bottom.

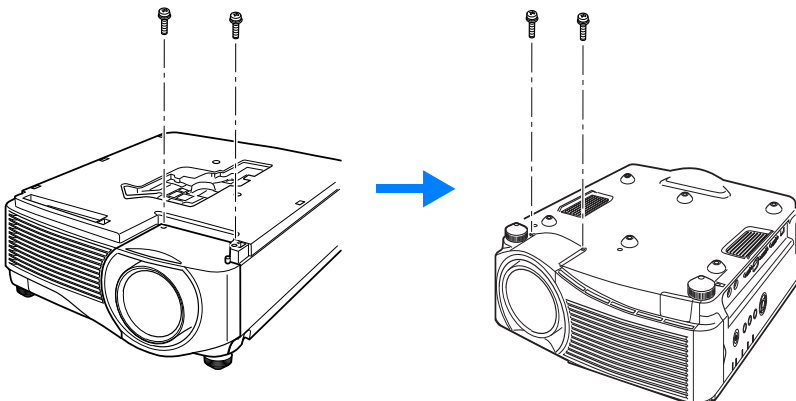

- 5** Then turn the projector back over and remove the sleeve.

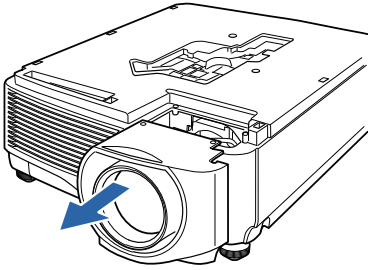

- 6** Referring to the following illustration, insert the lens connector of the lens unit into the front right side of the projector slowly until it contacts the end. At this time, pull out the lens cable shown in the illustration and fix it.

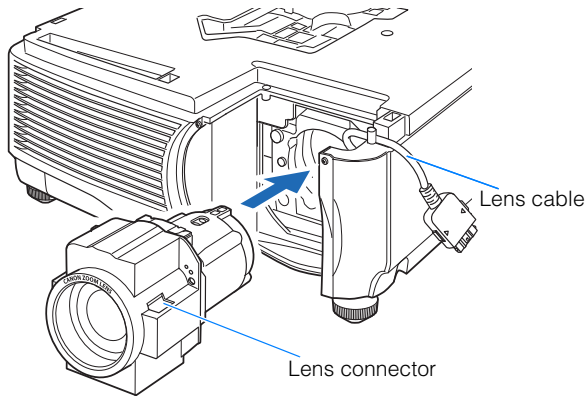

- 7** Tighten the 4 screws to fasten the lens unit in place.
The 4 lens unit screws are attached to the lens unit and cannot be removed.

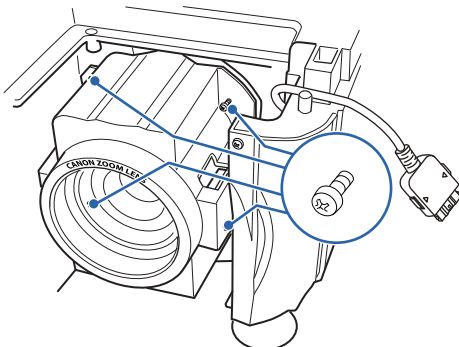

Installing / Removing the Lens Unit

- 8** Insert the projector lens cable into the connector until a click sound is heard.

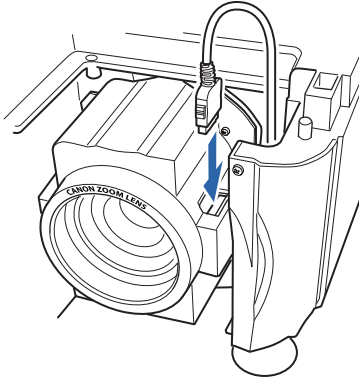

- 9** Reinstall the sleeve, cosmetic panel, and lamp cover in their original positions.



When the power is first turned on after the lens has been installed or replaced, lens shift initialization operation will be performed. It will take approximately 1 minute for the initialization operation to start up. However, if the lens has been replaced with a lens of the same model number, initialization operation will not be performed. The position will be the same as before the lens was replaced.



The lens shift initialization operation uses the motor to move the lens up / down / left / right. Do not touch the lens. Doing so could result in an injury.



Caution

When installing and removing the lens unit, be sure to fix the lens cable as shown in the illustration. When inserting the lens unit, it is possible to damage the lens cable between the lens unit and projector.

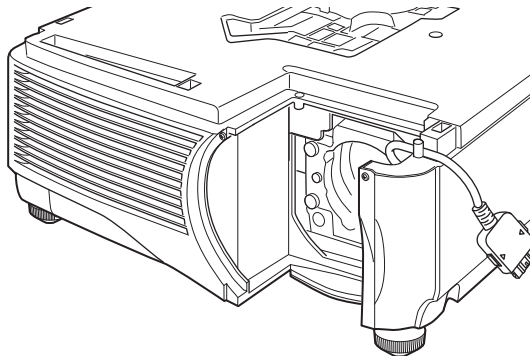

■ Removing the Lens Unit

- 1** Perform steps 1 to 5 on [pages 151 – 153](#) and remove the sleeve.
- 2** Disconnect the lens cable from the lens connector.

⚠ When pulling out (disconnecting) the lens cable, press the buttons on both sides of the lens cable connector while pulling out the cable.

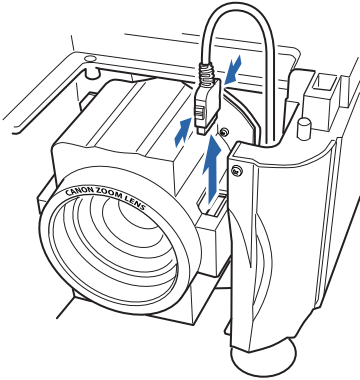

- 3** Fix the lens cable as shown in the illustration and loosen the 4 screws to remove the lens unit.

The 4 lens unit screws are attached to the lens unit and cannot be removed.

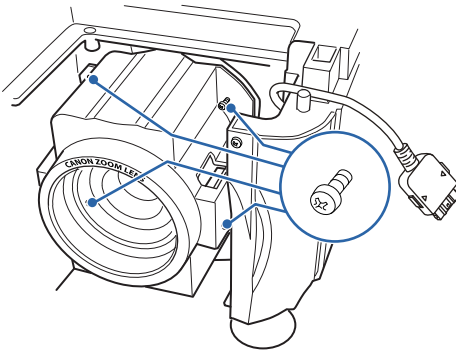

Setting Up the Projector

■ Positioning the Projector in Front of the Screen

Place the projector in front of the screen.

- ❗ Be sure to place the projector parallel to the screen to ensure distortion-free projection.
- The screen must not be exposed to direct sunlight or light from lighting equipment. In a bright room, it is recommended that lights be turned off, curtains be drawn, and other steps taken to make the screen easier to see.

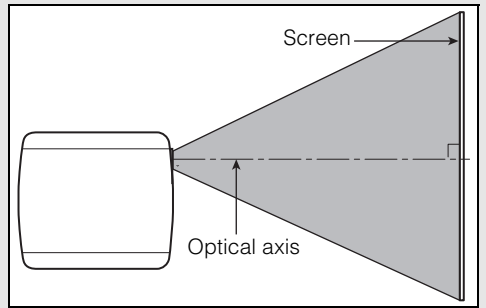

■ Relationship Between Image Size and Projecting Distance

The projected image size is determined by the distance between the projector and the screen (projection distance) as well as the zoom. Refer to the following table and decide the distance between the projector and screen.

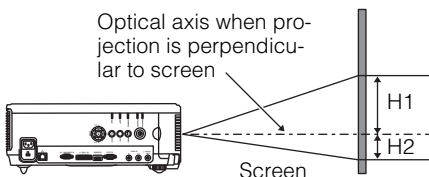
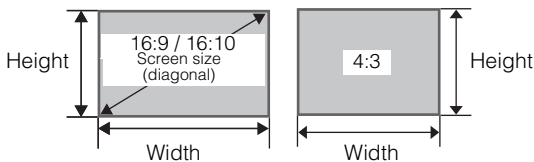

- ❗ H1 and H2 are the distances when lens shift is the default value below.
- Standard Zoom Lens / Long Zoom Lens / Ultra Long Zoom Lens: +50% (up / down), 0% (left / right)
- Short Fixed Lens: 0% (up / down / left / right)

WUX5000 / WUX4000

Lens unit	Diagonal when 16:10	Image size (cm)						Projection distance m (feet)		Distance from optical axis when projection is perpendicular to screen* (cm)	
		16:10		16:9		4:3		16:10			
		Width	Height	Width	Height	Width	Height	Wide limit	Tele limit	H1	H2
Standard Zoom Lens RS-IL01ST	40	86	54	86	48	72	54	1.3 (4.3)	1.9 (6.2)	54	0
	60	129	81	129	73	108	81	1.9 (6.2)	2.9 (9.5)	81	0
	80	172	108	172	97	144	108	2.6 (8.5)	3.9 (12.8)	108	0
	100	215	135	215	121	179	135	3.2 (10.5)	4.8 (15.7)	135	0
	150	323	202	323	182	269	202	4.8 (15.7)	7.2 (23.6)	202	0
	200	431	269	431	242	359	269	6.4 (21.0)	9.6 (31.5)	269	0
	250	538	337	538	303	449	337	8.0 (26.2)	12.1 (39.7)	337	0
	300	646	404	646	363	538	404	9.6 (31.5)	14.5 (47.6)	404	0
	350	754	471	754	424	628	471	11.3 (37.1)	16.9 (55.4)	471	0
	400	862	538	862	484	718	538	12.9 (42.3)	19.3 (63.3)	538	0
	450	969	606	969	544	808	606	14.5 (47.6)	21.7 (71.2)	606	0
	500	1077	673	1077	605	898	673	16.1 (52.8)	24.1 (79.1)	673	0
	550	1185	740	1185	666	987	740	17.7 (58.1)	26.6 (87.3)	740	0
600	1292	808	1292	726	1076	808	19.3 (63.3)	29.0 (95.1)	808	0	
Long Zoom Lens RS-IL02LZ	40	86	54	86	48	72	54	1.9 (6.2)	3.2 (10.5)	54	0
	60	129	81	129	73	108	81	2.8 (9.2)	4.8 (15.7)	81	0
	80	172	108	172	97	144	108	3.8 (12.5)	6.4 (21.0)	108	0
	100	215	135	215	121	179	135	4.7 (15.4)	8.0 (26.2)	135	0
	150	323	202	323	182	269	202	7.1 (23.3)	12.1 (39.7)	202	0
	200	431	269	431	242	359	269	9.5 (31.2)	16.1 (52.8)	269	0
	250	538	337	538	303	449	337	11.9 (39.0)	20.2 (66.3)	337	0
	300	646	404	646	363	538	404	14.2 (46.6)	24.2 (79.4)	404	0
	350	754	471	754	424	628	471	16.6 (54.5)	28.3 (92.8)	471	0
	400	862	538	862	484	718	538	19.0 (62.3)	32.3 (106.0)	538	0
	450	969	606	969	544	808	606	20.9 (68.6)	35.6 (116.8)	606	0
	500	1077	673	1077	605	898	673	23.8 (78.1)	40.4 (132.5)	673	0
	550	1185	740	1185	666	987	740	26.1 (85.6)	44.5 (146.0)	740	0
600	1292	808	1292	726	1076	808	28.5 (93.5)	48.5 (159.1)	808	0	
Short Fixed Lens RS-IL03WF	40	86	54	86	48	72	54	0.7 (2.3)		27	27
	60	129	81	129	73	108	81	1.0 (3.3)		41	41
	80	172	108	172	97	144	108	1.4 (4.6)		54	54
	100	215	135	215	121	179	135	1.7 (5.6)		68	68
	150	323	202	323	182	269	202	2.6 (8.5)		101	101
	200	431	269	431	242	359	269	3.4 (11.2)		135	135
	250	538	337	538	303	449	337	4.3 (14.1)		168	168
	300	646	404	646	363	538	404	5.2 (17.1)		202	202
	400	862	538	862	484	718	538				
Ultra long Zoom Lens RS-IL04UL	40	86	54	86	48	72	54	–	–	54	0
	60	129	81	129	73	108	81	4.6 (15.1)	9.0 (29.5)	81	0
	80	172	108	172	97	144	108	6.1 (20.0)	12.0 (39.4)	108	0
	100	215	135	215	121	179	135	7.6 (24.9)	14.9 (50.2)	135	0
	150	323	202	323	182	269	202	11.4 (37.4)	22.3 (77.3)	202	0
	200	431	269	431	242	359	269	15.2 (49.7)	29.8 (97.8)	269	0
	250	538	337	538	303	449	337	18.9 (62.0)	37.2 (122.0)	337	0
	300	646	404	646	363	538	404	22.7 (74.5)	44.6 (146.3)	404	0
	350	754	471	754	424	628	471	26.4 (86.6)	52.0 (170.6)	471	0
	400	862	538	862	484	718	538	30.2 (99.1)	59.4 (194.9)	538	0
	450	969	606	969	544	808	606	34.0 (111.5)	66.8 (219.2)	606	0
	500	1077	673	1077	605	898	673	37.7 (123.7)	74.2 (243.4)	673	0
	550	1185	740	1185	666	987	740	41.5 (136.2)	81.6 (267.7)	740	0
600	1292	808	1292	726	1076	808	45.2 (148.3)	89.0 (292.0)	808	0	

Setting Up the Projector

WX6000

Lens unit	Diagonal when 16:10	Image size (cm)						Projection distance m (feet)		Distance from optical axis when projection is perpendicular to screen* (cm)	
		16:10		16:9		4:3		16:10		H1	H2
		Width	Height	Width	Height	Width	Height	Wide limit	Tele limit		
Standard Zoom Lens RS-IL01ST	40	86	54	86	48	72	54	1.3 (4.3)	2.0 (6.6)	54	0
	60	129	81	129	73	108	81	2.0 (6.6)	3.0 (9.8)	81	0
	80	172	108	172	97	144	108	2.6 (8.5)	4.0 (13.1)	108	0
	100	215	135	215	121	179	135	3.3 (10.8)	4.9 (16.1)	135	0
	150	323	202	323	182	269	202	4.9 (16.1)	7.4 (24.3)	202	0
	200	431	269	431	242	359	269	6.6 (21.6)	9.9 (32.5)	269	0
	250	538	337	538	303	449	337	8.2 (26.9)	12.4 (40.7)	337	0
	300	646	404	646	363	538	404	9.9 (32.5)	14.9 (48.9)	404	0
	350	754	471	754	424	628	471	11.5 (37.7)	17.3 (56.8)	471	0
	400	862	538	862	484	718	538	13.2 (43.3)	19.8 (65.0)	538	0
	450	969	606	969	544	808	606	14.9 (48.9)	22.3 (73.2)	606	0
	500	1077	673	1077	605	898	673	16.5 (54.1)	24.8 (81.4)	673	0
550	1185	740	1185	666	987	740	18.2 (59.7)	27.2 (89.2)	740	0	
600	1292	808	1292	726	1076	808	19.8 (65.0)	29.7 (97.4)	808	0	
Long Zoom Lens RS-IL02LZ	40	86	54	86	48	72	54	1.9 (6.2)	3.3 (10.8)	54	0
	60	129	81	129	73	108	81	2.9 (9.5)	4.9 (16.1)	81	0
	80	172	108	172	97	144	108	3.9 (12.8)	6.6 (21.6)	108	0
	100	215	135	215	121	179	135	4.8 (15.7)	8.3 (27.2)	135	0
	150	323	202	323	182	269	202	7.3 (23.9)	12.4 (40.7)	202	0
	200	431	269	431	242	359	269	9.7 (31.8)	16.6 (54.5)	269	0
	250	538	337	538	303	449	337	12.2 (40.0)	20.7 (67.9)	337	0
	300	646	404	646	363	538	404	14.6 (47.9)	24.9 (81.7)	404	0
	350	754	471	754	424	628	471	17.1 (56.1)	29.0 (95.1)	471	0
	400	862	538	862	484	718	538	19.5 (64.0)	33.1 (108.6)	538	0
	450	969	606	969	544	808	606	21.9 (71.8)	37.3 (122.4)	606	0
	500	1077	673	1077	605	898	673	24.4 (80.1)	41.4 (135.8)	673	0
550	1185	740	1185	666	987	740	26.8 (87.9)	45.6 (149.6)	740	0	
600	1292	808	1292	726	1076	808	29.3 (96.1)	49.7 (163.1)	808	0	
Short Fixed Lens RS-IL03WF	40	86	54	86	48	72	54	0.7 (2.3)		27	27
	60	129	81	129	73	108	81	1.1 (3.6)		41	41
	80	172	108	172	97	144	108	1.4 (4.6)		54	54
	100	215	135	215	121	179	135	1.8 (5.9)		68	68
	150	323	202	323	182	269	202	2.7 (8.9)		101	101
	200	431	269	431	242	359	269	3.5 (11.5)		135	135
	250	538	337	538	303	449	337	4.4 (14.4)		168	168
	300	646	404	646	363	538	404	5.3 (17.4)		202	202
Ultra long Zoom Lens RS-IL04UL	40	86	54	86	48	72	54	–	–	54	0
	60	129	81	129	73	108	81	4.8 (15.7)	9.2 (30.2)	81	0
	80	172	108	172	97	144	108	6.3 (20.7)	12.3 (40.4)	108	0
	100	215	135	215	121	179	135	7.8 (25.6)	15.3 (50.2)	135	0
	150	323	202	323	182	269	202	11.7 (38.4)	22.9 (75.1)	202	0
	200	431	269	431	242	359	269	15.6 (51.2)	30.5 (100.1)	269	0
	250	538	337	538	303	449	337	19.4 (63.6)	38.1 (125.0)	337	0
	300	646	404	646	363	538	404	23.3 (76.4)	45.7 (149.9)	404	0
	350	754	471	754	424	628	471	27.1 (88.9)	53.3 (174.9)	471	0
	400	862	538	862	484	718	538	31.0 (101.7)	60.9 (199.8)	538	0
	450	969	606	969	544	808	606	34.8 (114.2)	68.5 (224.7)	606	0
	500	1077	673	1077	605	898	673	38.7 (127.0)	76.1 (249.7)	673	0
550	1185	740	1185	666	987	740	42.5 (139.4)	83.7 (274.6)	740	0	
600	1292	808	1292	726	1076	808	46.4 (152.2)	91.3 (299.5)	808	0	

Setting Up the Projector

SX6000

Lens unit	Diagonal when 4:3	Image size (cm)						Projection distance m (feet)		Distance from optical axis when projection is perpendicular to screen* (cm)	
		4:3		16:10		16:9		4:3			
		Width	Height	Width	Height	Width	Height	Wide limit	Tele limit	H1	H2
Standard Zoom Lens RS-IL01ST	40	81	61	81	51	81	46	1.3 (4.3)	1.9 (6.2)	61	0
	60	122	91	122	76	122	69	1.9 (6.2)	2.9 (9.5)	91	0
	80	163	122	163	102	163	91	2.5 (8.2)	3.8 (12.5)	122	0
	100	203	152	203	127	203	114	3.2 (10.5)	4.8 (15.7)	152	0
	150	305	229	305	191	305	171	4.8 (15.7)	7.2 (23.6)	229	0
	200	406	305	406	254	406	229	6.4 (21.0)	9.6 (31.5)	305	0
	250	508	381	508	318	508	286	8.0 (26.2)	12.0 (39.4)	381	0
	300	610	457	610	381	610	343	9.6 (31.5)	14.4 (47.2)	457	0
	350	711	533	711	445	711	400	11.2 (36.7)	16.8 (55.1)	533	0
	400	813	610	813	508	813	457	12.8 (42.0)	19.2 (63.0)	610	0
	450	914	686	914	572	914	514	14.4 (47.2)	21.6 (70.9)	686	0
	500	1016	762	1016	635	1016	572	16.0 (52.5)	24.0 (78.7)	762	0
	550	1118	838	1118	699	1118	629	17.6 (57.7)	26.4 (86.6)	838	0
	600	1219	914	1219	762	1219	686	19.2 (63.0)	28.8 (94.5)	914	0
Long Zoom Lens RS-IL02LZ	40	81	61	81	51	81	46	1.9 (6.2)	3.2 (10.5)	61	0
	60	122	91	122	76	122	69	2.8 (9.2)	4.8 (15.7)	91	0
	80	163	122	163	102	163	91	3.7 (12.1)	6.4 (21.0)	122	0
	100	203	152	203	127	203	114	4.7 (15.4)	8.0 (26.2)	152	0
	150	305	229	305	191	305	171	7.1 (23.3)	12.0 (39.4)	229	0
	200	406	305	406	254	406	229	9.4 (30.8)	16.1 (52.8)	305	0
	250	508	381	508	318	508	286	11.8 (38.7)	20.1 (65.9)	381	0
	300	610	457	610	381	610	343	14.2 (46.6)	24.1 (79.6)	457	0
	350	711	533	711	445	711	400	16.5 (54.1)	28.1 (92.2)	533	0
	400	813	610	813	508	813	457	18.9 (62.0)	32.2 (105.6)	610	0
	450	914	686	914	572	914	514	21.3 (69.9)	36.2 (118.8)	686	0
	500	1016	762	1016	635	1016	572	23.7 (77.8)	40.2 (131.9)	762	0
	550	1118	838	1118	699	1118	629	26.0 (85.3)	44.2 (145.0)	838	0
	600	1219	914	1219	762	1219	686	28.4 (93.2)	48.3 (158.5)	914	0
Short Fixed Lens RS-IL03WF	40	81	61	81	51	81	46	0.7 (2.3)		30	30
	60	122	91	122	76	122	69	1.0 (3.3)		46	46
	80	163	122	163	102	163	91	1.4 (4.6)		61	61
	100	203	152	203	127	203	114	1.7 (5.6)		76	76
	150	305	229	305	191	305	171	2.6 (8.5)		114	114
	200	406	305	406	254	406	229	3.4 (11.2)		152	152
	250	508	381	508	318	508	286	4.3 (14.1)		191	191
	300	610	457	610	381	610	343	5.1 (16.7)		229	229
Ultra long Zoom Lens RS-IL04UL	40	81	61	81	51	81	46	–	–	61	0
	60	122	91	122	76	122	69	4.6 (15.1)	9.0 (29.5)	91	0
	80	163	122	163	102	163	91	6.1 (20.0)	11.9 (39.0)	122	0
	100	203	152	203	127	203	114	7.6 (24.9)	14.9 (48.9)	152	0
	150	305	229	305	191	305	171	11.3 (37.1)	22.2 (72.8)	229	0
	200	406	305	406	254	406	229	15.1 (49.5)	29.6 (97.1)	305	0
	250	508	381	508	318	508	286	18.8 (61.7)	37.0 (121.4)	381	0
	300	610	457	610	381	610	343	22.6 (74.1)	44.4 (145.7)	457	0
	350	711	533	711	445	711	400	26.3 (86.3)	51.7 (169.6)	533	0
	400	813	610	813	508	813	457	30.0 (98.4)	59.1 (193.9)	610	0
	450	914	686	914	572	914	514	33.8 (110.9)	66.5 (218.2)	686	0
	500	1016	762	1016	635	1016	572	37.5 (123.0)	73.8 (242.1)	762	0
	550	1118	838	1118	699	1118	629	41.3 (135.5)	81.2 (266.4)	838	0
	600	1219	914	1219	762	1219	686	45.0 (147.6)	88.6 (290.7)	914	0

Setting Up the Projector

■ Lens Shift Function

The projector includes a lens shift function. Operation of the buttons slides the lens up, down, left, and right, moving the image position. For the function operations, refer to [page 74](#).

The amount of lens shift is indicated as a percentage relative to the image height and width.

The table below shows the lens shift for each lens.

		WUX5000	WUX4000	WX6000	SX6000
Standard Zoom Lens (RS-IL01ST)	Up (1)	+55%	+55%	+55%	+50%
	Down (2)	-15%	-15%	-15%	-12%
	Left/right (3)	±10%	±10%	±10%	±10%
Long Zoom Lens (RS-IL02LZ)	Up (1)	+55%	+55%	+55%	+50%
	Down (2)	-15%	-15%	-15%	-12%
	Left/right (3)	±10%	±10%	±10%	±10%
Short Fixed Lens (RS-IL03WF)	Up (1)	+5%	+5%	+5%	+5%
	Down (2)	-5%	-5%	-5%	-5%
	Left/right (3)	±2%	±2%	±2%	±2%
Ultra Long Zoom Lens (RS-IL04UL)	Up (1)	+55%	+55%	+55%	+50%
	Down (2)	-15%	-15%	-15%	-12%
	Left/right (3)	±10%	±10%	±10%	±10%

Amount movable in up/down direction

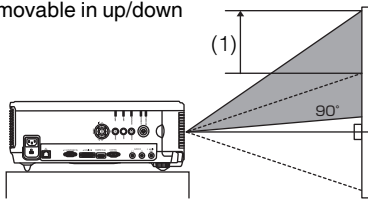

At maximum upward lens shift

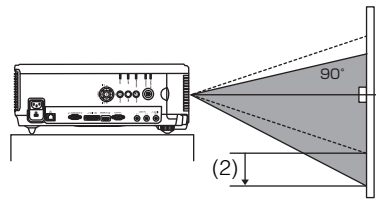

At maximum downward lens shift

Amount movable in left/right direction

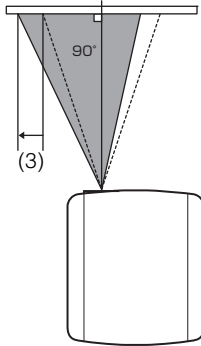

At maximum leftward lens shift

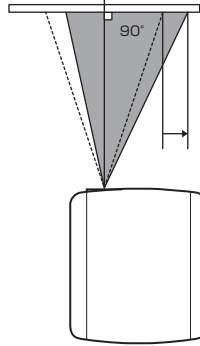

At maximum rightward lens shift

Area where lens movement is not possible

With the Standard Zoom Lens, Long Zoom Lens and Ultra Long Zoom Lens, when the shift exceeds 44% in the upward direction, the amount of available shift in the left / right directions decreases. When the lens is shifted upward to the maximum (1), the amount of available shift in the left / right direction is $\pm 2\%$.

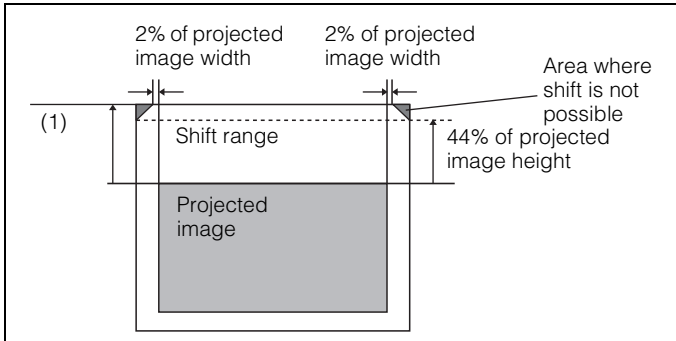

With the Short Fixed Lens, greater shift in the up / down direction reduces the available shift in the left / right direction. When the lens is shifted upward or downward to the maximum, shift in the left / right direction is not possible.

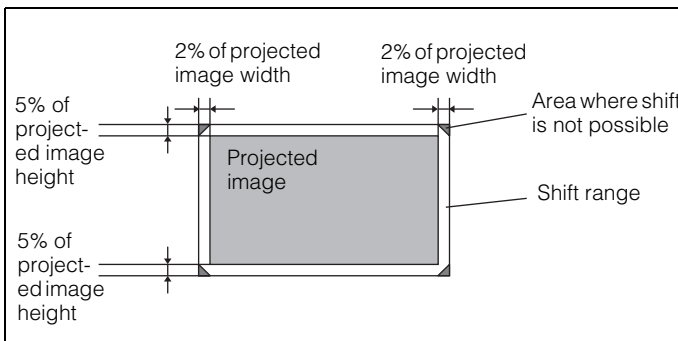

Connecting to AV Equipment

■ Connectable Equipment and Input Terminals

HDMI	Use this name to select the image input.  Direction of signal and data flow
HDMI IN terminal	The name of the terminal to which to connect equipment. (Pxxx): indicates the page(s) to refer to.

WUX5000 / WUX4000

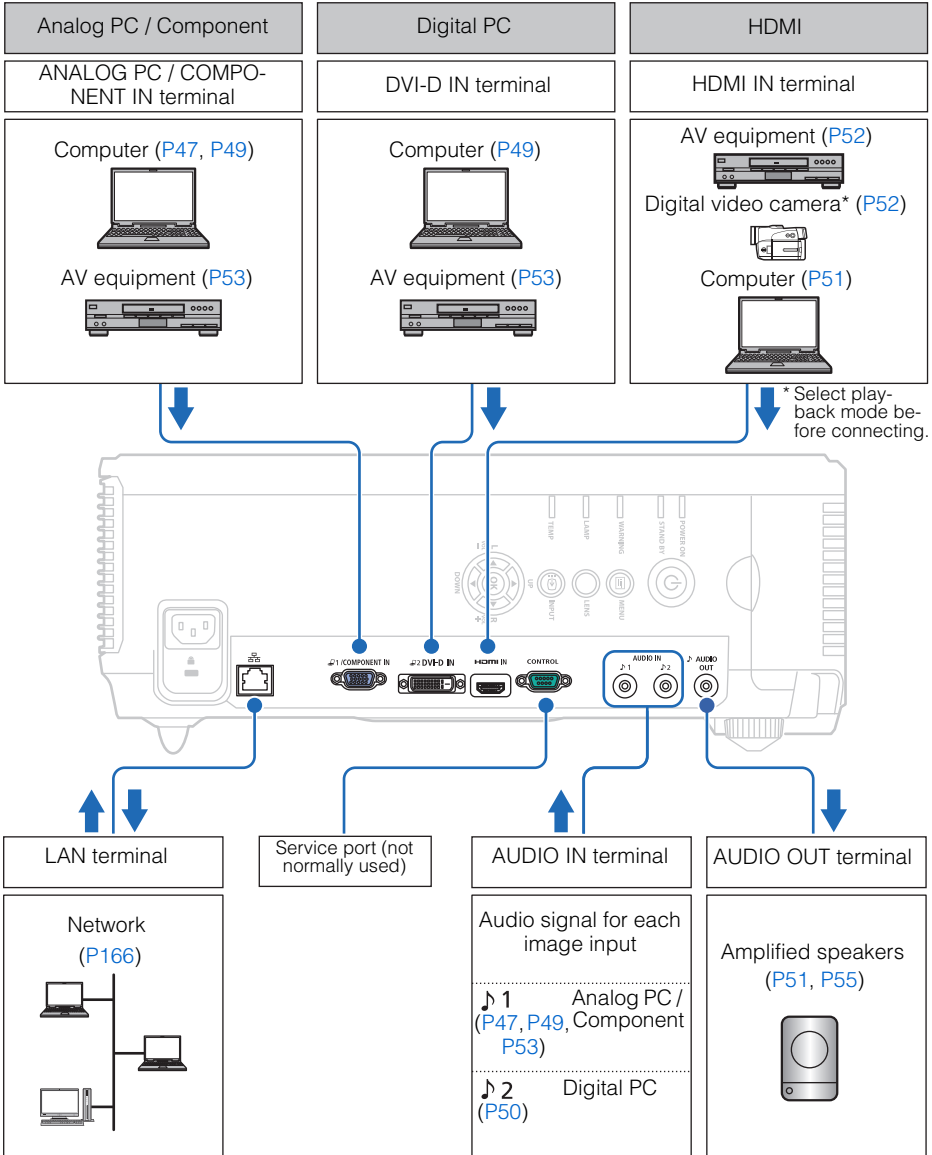



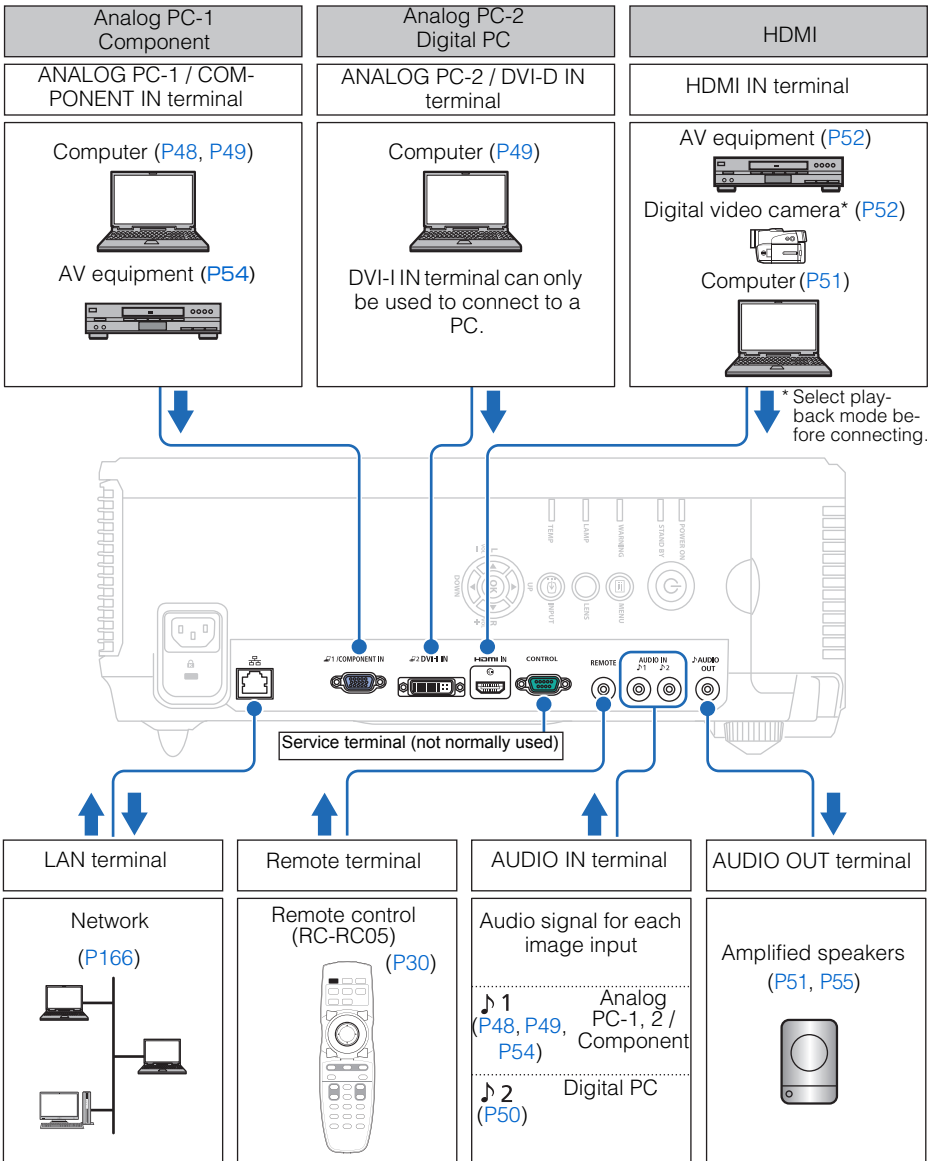



WX6000 / SX6000

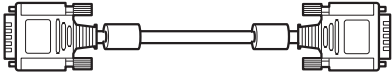

Connecting to AV Equipment

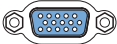
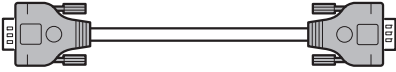
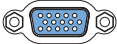
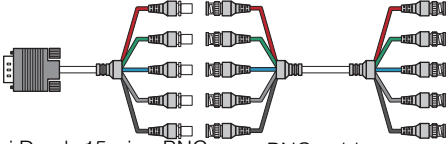
■ Connection Terminal and Connection Cable

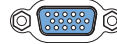
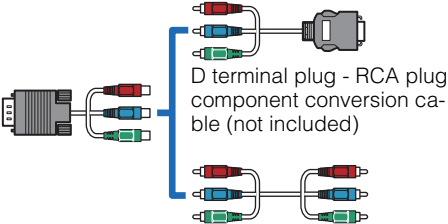
Input signal	Supported projectors	Input terminal	Types of connection cables
HDMI	WUX5000 WUX4000 WX6000 SX6000	HDMI IN 	HDMI cable (not included) 
Digital PC	WUX5000 WUX4000	DVI-D IN 	DVI cable (not included) 
	WX6000 SX6000	DVI-I IN 	
Analog PC Analog PC-1	WUX5000 WUX4000 WX6000 SX6000	COMPONENT IN 	VGA cable (supplied) 
	WUX5000 WUX4000 WX6000 SX6000	COMPONENT IN 	BNC cable (not included)  Mini D-sub 15-pin - BNC terminal converter cable (not included)
Analog PC-2	WX6000 SX6000	DVI-I IN 	VGA-DVI cable (not included) 
Component	WUX5000 WUX4000 WX6000 SX6000	COMPONENT IN 	Component cable (not included)  D terminal plug - RCA plug component conversion cable (not included) RCA plug - RCA plug component cable (not included)

Connecting to a Network

Table of Contents

Safety Instructions

Before Use

Projecting an Image

Useful Functions Available
During a Presentation

Setting Functions from Menus

Installation

Connecting to a Network

Maintenance

Appendix

Index

User's Manual

Installation Manual

Appendix

Preparing the Remote Control

If the projector is connected to a network, projector error notification mails can be received and the projector can be controlled via a computer. Settings related to the network connection can be made from either the projector side (P172) or computer side (P177).

Depending on the method of network connection, preparation on the computer side may be necessary. The following is an explanation of preparation on the computer side.

Connection Methods

Connect the projector to the computer via LAN.

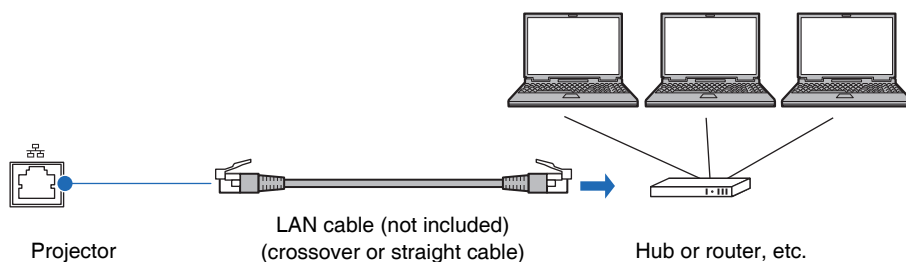

- When the [Network function] setting of the projector is set to [Off] (Network Connections is disabled), switch it to [On] to enable it (P172).
- Referring to [page 141](#), check that the projector IP address does not overlap with other computers that are on the same LAN. When you set the IP address of the projector, follow the instruction on [page 177](#) on the web screen or refer to [page 175](#).
- When you connect the computer to the network for the first time, it is also necessary to perform settings on the computer. In this case, consult the network administrator regarding the necessary settings.



In a network environment where a DHCP server is operating, choose [On] on the projector [DHCP] screen to enable the DHCP function and connect it (P175).

Setting an IP Address

Following is an explanation of how to set the PC IP address for each operating system.

■ Windows 7

- 1** From the PC [Start] menu, select [Control Panel].
- 2** Click on [Network and Internet Connections], then click on [View network status and tasks].
- 3** From the menu on the left side of the window, click on [Change adapter settings].
- 4** Right-click [Local Area Connection], and open [Properties].
- 5** Select [Internet Protocol Version 4 (TCP/IP)] and click the [Properties] button. Make a note of the original network settings (IP address, subnet mask, default gateway, etc).
- 6** Select [Use the following IP address] and set the IP address and subnet mask. The factory default IP address for the projector is "192.168.254.254". Set an IP address which is different from this.

Example

IP address: 192.168.254.1

Subnet mask: 255.255.255.0

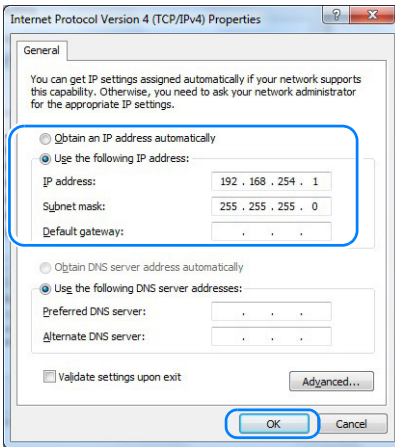

- 7** When the settings are completed, click the [OK] button and then click the [OK] button on the [Local Area Connection Properties] window to close it.

Preparing the Remote Control

■ Windows Vista

- 1** From the PC [Start] menu, select [Control Panel].
- 2** Click on [View network status and tasks].
- 3** From the menu on the left side of the window, click on [Manage network connections].
- 4** Right-click [Local Area Connection], and open [Properties].
- 5** Select [Internet Protocol Version 4 (TCP/IP)] and click the [Properties] button. Make a note of the original network settings (IP address, subnet mask, default gateway, etc).
- 6** Select [Use the following IP address] and set the IP address and subnet mask. The factory default IP address for the projector is "192.168.254.254". Set an IP address which is different from this.

Example

IP address: 192.168.254.1

Subnet mask: 255.255.255.0

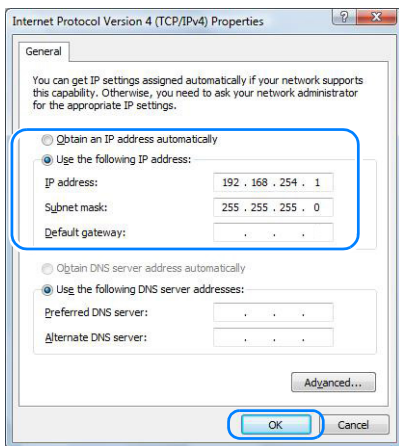

- 7** When the settings are completed, click the [OK] button and then click the [OK] button on the [Local Area Connection Properties] window to close it.

■ Windows XP

- 1** From the PC [Start] menu, select [Control Panel].
- 2** Select [Network and Internet Connections] and open [Network Connections].
- 3** Right-click [Local Area Connection], and open [Properties].
- 4** Select [Internet Protocol (TCP/IP)] and click the [Properties] button. Make a note of the original network settings (IP address, subnet mask, default gateway, etc).
- 5** Select [Use the following IP address] and set the IP address and subnet mask. The factory default IP address for the projector is "192.168.254.254". Set an IP address which is different from this.

Example

IP address: 192.168.254.1

Subnet mask: 255.255.255.0

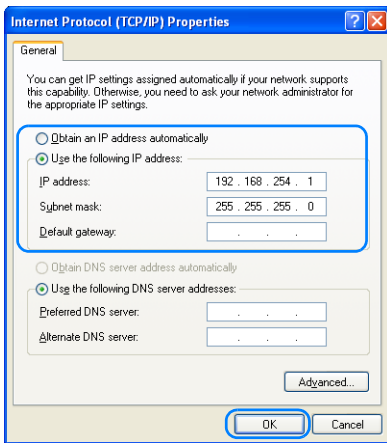

- 6** When the settings are completed, click the [OK] button and then click the [OK] button on the [Local Area Connection Properties] window to close it.

Preparing the Remote Control

■ Mac OS X

- 1 Open the Apple Menu and select [System Preferences].
- 2 In the System Preferences window, click [Network] to display the Network window.
- 3 Select [Built-in Ethernet] and click the [TCP/IP] tab. Make a note of the original network settings (IP address, subnet mask, router, DNS server, etc.).
- 4 Create a new network environment and set the IP address and subnet mask. The factory default IP address for the projector is "192.168.254.1". Set an IP address which is different from this.

Example

IP address: 192.168.254.1

Subnet mask: 255.255.255.0

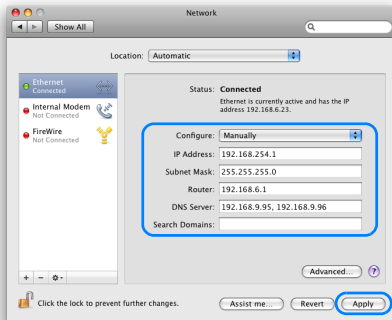

- 5 Click [Apply] to close the network preference window.

■ Resetting the IP Address Setting of the Computer

Follow the same procedure as for changing the IP address and reset the values to the original values based on the notes taken before the change.

Network Settings on the Projector

From the projector menu screen, network settings can be configured in the [Network Setting] tab. For the menu operations, refer to [page 88](#).

(The screen is for the WUX5000 / WUX4000.)

Locking the Network Settings

You can lock / unlock the network settings so that they cannot be changed and cancel the lock.

MENU > [Network Setting] > [Network Setting lock]

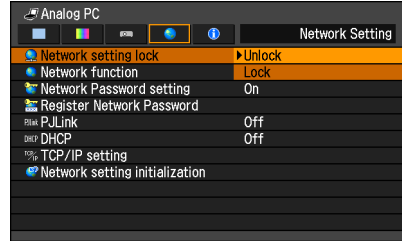

Unlock

Cancels the lock and allows other network settings to be changed. The password must be entered in order to cancel the lock.

When [Unlock] is selected, the window shown below appears. Use the [▲] / [▼] / [◀] / [▶] buttons to enter the 4-digit password.

For the WX6000 / SX6000, numbers can be entered using the numerical buttons on the remote control.

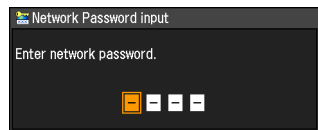

Lock

Lock the settings.

After the **OK** button is pressed to accept your setting and the **MENU** button or the **EXIT** button (WUX6000 / SX6000) is pressed to close the window, the lock is re-engaged. If you change the network settings, be sure to continue operating without closing the window.

- [Lock] is the factory default.
- For the default network password, refer to [page 173](#).

Network Settings on the Projector

Forcibly canceling the network lock

In the Network Password Input screen, press the buttons in the following sequence to cancel the lock: [▲] [OK] [▶] [OK] [▼] [OK]. This will reset the network password to [▲] [▲] [▲] [▲].

Turning the Network Function On / Off

You can turn the projector network function on or off. Power can be saved by turning the function [Off].

MENU > [Network Setting] > [Network function]

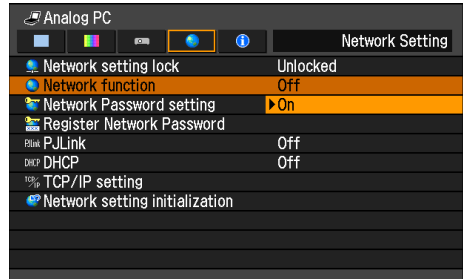

Off Disables the network function.

On Enables the network function.

Press the **OK** button to accept your setting and then press the **MENU** button or **EXIT** button (WX6000 / SX6000).

- [Off] is the factory default.

Setting a Network Password

You can set whether or not a password is required in order to change the projector network settings.

MENU > [Network Setting] > [Network Password setting]

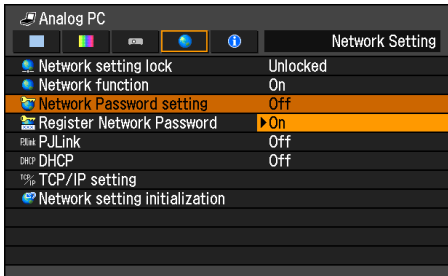

- | | |
|-----|---------------------------------|
| Off | A network password is not used. |
| On | A network password is used. |

Press the **OK** button to accept your setting and then press the **MENU** button or **EXIT** button (WX6000 / SX6000).

- [On] is the factory default.

Registering a Network Password

Register the projector network password.

MENU > [Network Setting] > [Register Network Password]

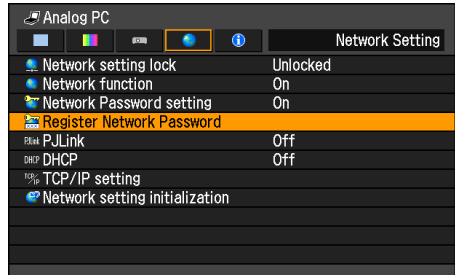

When [Register Network Password] is selected, the window shown below appears.

Enter a 4 digit password.

For the WUX5000 / WUX4000, the password can be entered using the [▼] / [▲] / [◀] / [▶] buttons. For the WX6000 / SX6000, the password can be entered using a combination of the numerical buttons and the [▼] / [▲] / [◀] / [▶] buttons. [▲] / [1], [▶] / [2], [▼] / [3], and [◀] / [4] have the same function.

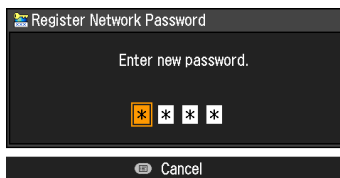

Press the **OK** button to accept your setting and then press the **MENU** button or **EXIT** button (WX6000 / SX6000).

- The factory default is [▲] [▲] [▲] [▲] (WUX5000 / WUX4000) or [1] [1] [1] [1] (WX6000 / SX6000).

Turning the PJLink Function On / Off

You can turn the PJLink network function on or off. When the function is turned on, control is possible via the LAN using commands that meet PJLink standards.

MENU > [Network Setting] > [PJLink]

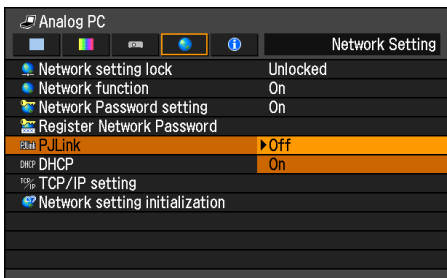

Off Disables the PJLink function.

On Enables the PJLink function.

Press the **OK** button to accept your setting and then press the **MENU** button or **EXIT** button (WX6000 / SX6000).

- [On] is the factory default.
- This projector conforms to Class 1 as defined in the PJLink standards of the JBMIA (Japan Business Machine and Information System Industries Association). This projector supports all commands that are defined by PJLink Class 1, and has been verified as conforming to the PJLink standard Class 1 definition.
- For information about using PJLink, refer to [page 187](#).

What is PJLink?

In September 2003, the PJLink Working Group was established under the Data Projector Committee. During the first year, this PJLink Working Group standardized PJLink as a new interface specification for projectors.

PJLink is a unified standard for operation and control of projectors.

It allows centralized control of projectors and operation from a controller for all projectors regardless of manufacturer.

The objective is for JBMIA to improve convenience for users and expand the use of projectors through early systemization for network monitoring and control of projectors, which will become the mainstream in the future.

Class 1: Standardization of control and monitoring specifications for basic projector functions
Basic projector control: Power control, input selection, etc.

Acquisition of projector information and status: Power status, input selection status, error status, lamp use time, etc.

JBMIA: Japan Business Machine and Information System Industries Association

The Japan Business Machine and Information System Industries Association is an organization which was launched in 1960 and changed its name on April 1, 2002.

PJLink[™]

PJLink is a registered trademark of JBMIA and pending trademark in some countries.

Turning DHCP Function On / Off

You can turn the projector DHCP function on or off.

MENU > [Network Setting] > [DHCP]

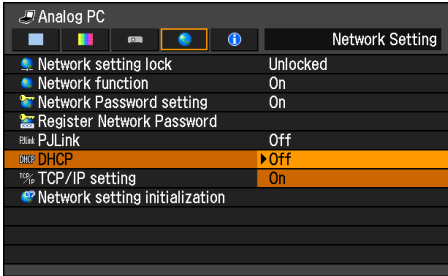

Off Disables the DHCP function. TCP / IP settings are possible.

On Enables the DHCP function. Searches the DHCP server. Because the IP address is acquired from the DHCP server, it is not necessary to enter the TCP / IP settings (IP address, subnet mask, gateway address).

Press the **OK** button to accept your setting and then press the **MENU** button or **EXIT** button (WX6000 / SX6000).

- [Off] is the factory default.

TCP / IP Setting

Configure the projector TCP / IP settings.

MENU > [Network Setting] > [TCP/IP setting]

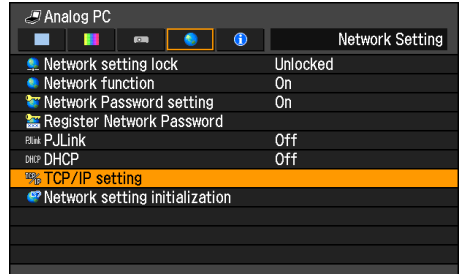

When [TCP/IP setting] is selected, the window shown below appears. Use the [▲] / [▼] buttons to select the IP address, then press the **OK** button. Next, use the [◀] / [▶] buttons to select the digit and the [▲] / [▼] buttons to change the value. For the WX6000 / SX6000, numbers can be entered using the numerical buttons on the remote control. Press the **OK** button, then set the subnet mask and gateway address in the same way. Finally, select [Enter].

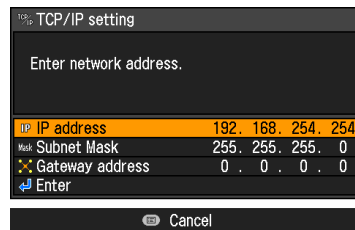

- The factory defaults are shown below.
IP address 192.168.254.254
Subnet mask 255.255.255.0
Gateway address 0.0.0.0
- Settings cannot be made when [DHCP] (P175) is [On].
- If an invalid value is entered, the message "Invalid entry" appears. If this occurs, enter a valid value.

Initializing Network Settings

You can initialize the projector network settings.

MENU > [Network Setting] > [Network setting initialization]

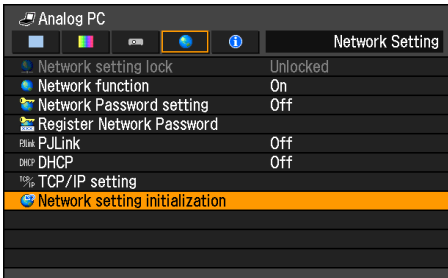

When [Network setting initialization] is selected, the window shown below appears. Select [YES] then press the **OK** button.

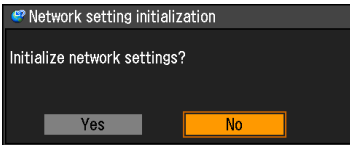

- The following items are initialized.
 - Network setting screen user name, various settings including password
 - Network Password setting
 - Register Network Password
 - PLink
 - DHCP
 - IP address
 - Subnet mask
 - Gateway address
 - E-mail sender address
 - E-mail recipient address
 - Projector name
 - Location

Configuring the Network From the Computer

■ Displaying and Configuring the Network Configuration Screen

The web browser screen shown below is for the WUX4000.

- 1 Turn on the computer and projector.
- 2 Launch a web browser, enter “http://(projector IP address)” in the address bar, and press the Enter key.
The password input screen appears.

⚠ The factory default IP address is “192.168.254.254”. If DHCP settings are used, ask the network administrator for the projector IP address. It is possible to check the IP address from the projector menu.

- 3 Enter the user name and password on the password input screen, then click OK.
The factory default user name is “root” and the password is “system”.

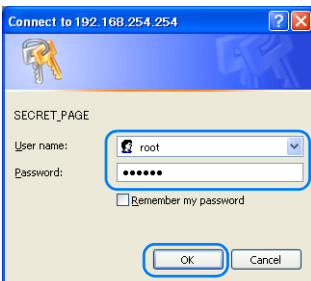

The projector web screen appears in the web browser.

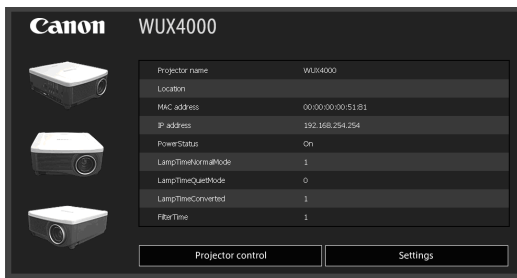

Configuring the Network From the Computer

The following information is displayed.

Projector name	The name of the projector on the network
Location	The location of projector installation
MAC address	The MAC address of the projector
IP address	The IP address of the projector
Power Status	The power status of the projector
Lamp Time *1	Lamp operating time
Lamp Time Normal Mode *2	Lamp operating time in [Normal] lamp mode
Lamp Time Quiet Mode *2	Lamp operating time in [Quiet] lamp mode
Lamp Time Converted *2	Lamp operating time (converted value)
Filter Time	Air filter operating time
Alert	Error message (if an error has occurred) Temperature abnormality Faulty lamp Faulty lamp cover Faulty cooling fan Faulty power supply Faulty lens connector: Lens connector error Faulty air filter unit: Air filter error Unknown error

*1 WUX5000 / WX6000 / SX6000

*2 WUX4000



To operate the projector from the computer, click [Projector control] (P188).

4

To configure, click [Settings].

The settings window appears.

WUX4000
WUX4000

Projector control Back to top

Network

Mail

Mail auth

Send test mail

SNMP

Projector info.

PjLink

Initialize

Password

User name root 4 - 15 characters

New password ***** 4 - 15 characters

Confirm new password ***** 4 - 15 characters

TCP/IP

DHCP OFF

IP address 192.168.254.254

Subnet mask 255.255.255.0

Default gateway 0.0.0.0

OK Cancel

Configuring the Network From the Computer

- 5** Select the function to set from the menu (1), then enter the setting in the displayed field (2) and click [OK] (3).



- 6** A confirmation window appears. Check the contents and if they are correct, click [Apply].

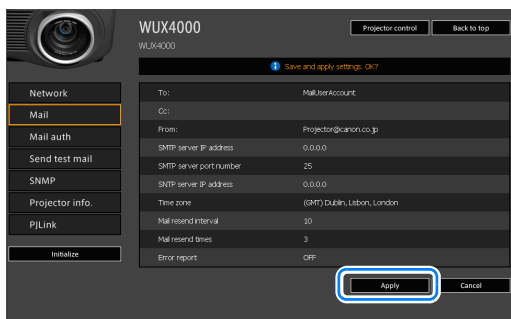

The settings are applied to the projector and “Save completed” is displayed.

- 7** Click [Back to top] to return the web screen to the initial page.

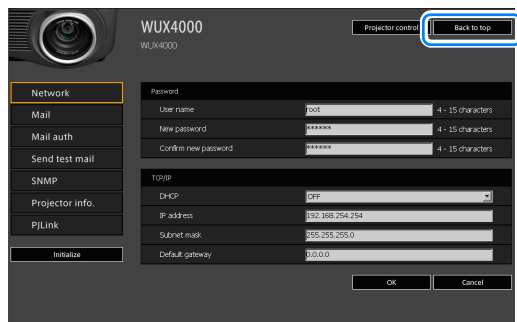

Configuring the Network From the Computer

■ Resetting to Factory Defaults

- 1 Perform steps 1 - 3 on [page 177](#) to display the setting window.
- 2 Click [Initialize].

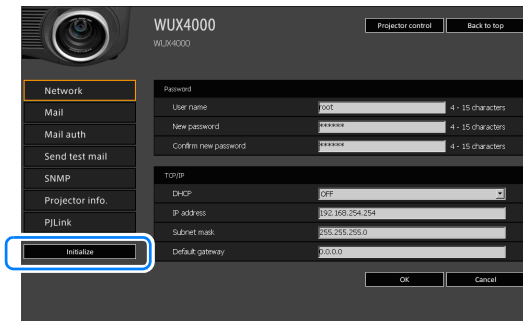

- 3 A confirmation window appears. Click [OK].

■ Setting Errors

When a setting-related error occurs, the error name is displayed on the screen, and a “!” mark is displayed next to the input field which caused the error.

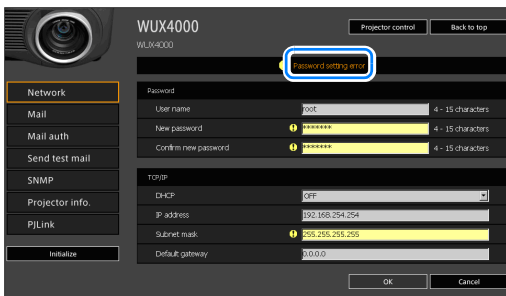

Configuring the Network From the Computer

The error meanings are as shown below.

Error	Meaning
Input error	A setting outside the valid range was set on the setting screen.
Password setting error	The set password and confirmation password did not match.
Invalid SMTP	The SMTP server IP address has not been set.
System failed to connect SMTP server.	Failed to connect to the SMTP server when sending a test mail.
System failed to connect POP3 server.	Failed to connect to the POP3 server attempting to send a test mail.
System doesn't support this auth type.	An authentication type was set which is not supported by the server.
System failed to authenticate.	Authentication failed attempting to send a test mail.
The system failed to send the test mail.	Sending of test mail failed due to a connection failure with the SMTP server or an error which does not ordinarily occur.
Save Failed	Mismatch in settings occurred when settings were changed at the same time from multiple computers.

Setting Up the Network

■ Setting Basic Information [Network]

From [Network] in the settings window, you can log into the web screen and set basic network information. For the setting procedure, refer to [page 177](#).

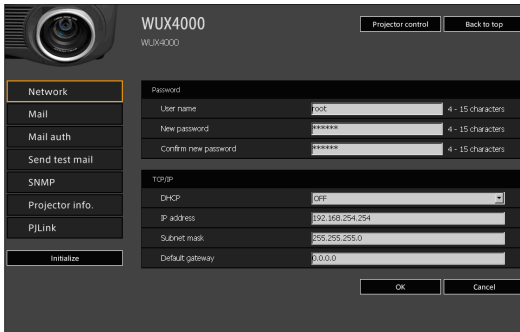

Item	Explanation	Factory default setting
Password		
User name	When logging into the web screen, enter the user name in 1-byte alphanumeric characters and symbols (4 -15 characters).	root
New password	When logging into the web screen, enter the password in 1-byte alphanumeric characters and symbols (4 -15 characters).	system
Confirm new password	For confirmation, enter the same password that you entered in [New password].	system
TCP/IP		
DHCP	Select whether to turn the DHCP function on or off. If the function is on, because the IP address is acquired from the server, it is not possible to enter the [IP address], [Subnet mask], and [Default gateway].	OFF
IP address	Enter the IP address of the projector in 1-byte numbers.	192.168.254.254
Subnet mask	Enter the subnet mask in 1-byte numbers.	255.255.255.0
Default gateway	Enter the default gateway IP address in 1-byte numbers.	0.0.0.0



If settings related to TCP / IP were changed, it is necessary to disconnect and reconnect to the network. If the network subnet mask was changed, select [Subnet mask] in the above window and set the new subnet mask.

■ Setting Up Email [Mail]

From [Mail] in the settings window, you can set the items necessary to send error mails and test mails. For the setting procedure, refer to [page 177](#).

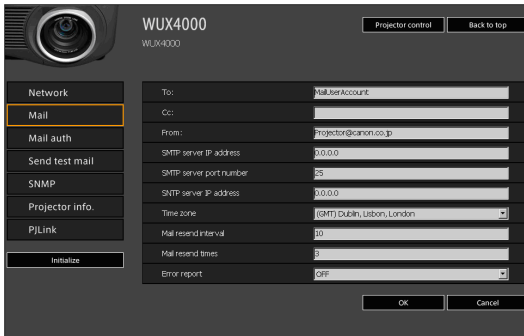

Item	Explanation	Factory default setting
To:	Enter the recipient address for error mails in 1-byte alphanumeric characters and symbols (1 - 63 characters).	MailUserAccount
Cc:	Enter the CC address for error mails in 1-byte alphanumeric characters and symbols (1 - 63 characters).	<Blank>
From:	Enter the sender address for error mails in 1-byte alphanumeric characters and symbols (1 - 63 characters).	Projector@canon.co.jp
SMTP server IP address	Enter the SMTP server IP address in 1-byte numbers.	0.0.0.0
SMTP server port number	Enter the SMTP server port number in 1-byte numbers (1 - 65535).	25
SMTP server IP address	Enter the SMTP server IP address in 1-byte numbers.	0.0.0.0
Time zone	Select the time zone where the projector is used.	(GMT) Dublin, Lisbon, London
Mail resend interval	Enter the interval for resending mail when an error occurred (units: seconds) within the range of 0 - 59 seconds using 1-byte numbers.	10
Mail resend times	Enter the number of times to resend mail when an error occurred within the range of 0 - 255 using 1-byte numbers.	3
Error report	Select whether to turn the error mail sending function on or off.	OFF

Setting Up the Network

■ Mail Authentication Settings [Mail auth]

From [Mail auth] in the settings window, you can configure the settings for authentication of mail that is sent when an error occurs. For the setting procedure, refer to [page 177](#).

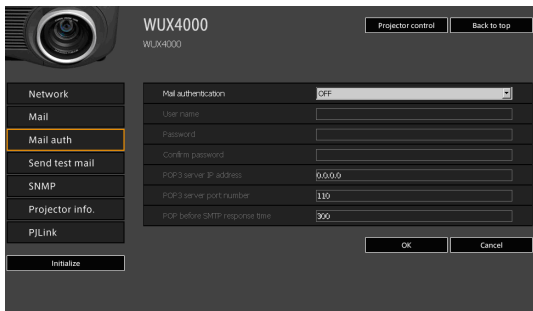

Item	Explanation	Factory default setting
Mail authentication	Select the mail authentication method. If OFF is selected, the other mail authentication settings cannot be changed.	OFF
User name	Enter the user name to use for mail authentication in 1-byte alphanumeric characters and symbols (1 - 63 characters).	<Blank>
Password	Enter the password for mail authentication in 1-byte alphanumeric characters and symbols (1 - 63 characters).	<Blank>
Confirm password	For confirmation, enter the same password as you entered in [Password].	<Blank>
POP3 server IP address	Enter the POP3 server IP address in 1-byte numbers.	0.0.0.0
POP3 server port number	Enter the POP3 server port number in 1-byte numbers (1 - 65535).	110
POP before SMTP response time	Enter the wait time from POP3 authentication to SMTP authentication (units: milliseconds) using 1-byte numbers (0 - 9999 milliseconds).	300

■ Sending a Test Mail [Send test mail]

From [Send test mail] in the settings window, you can send a test mail to the mail address that was set in [Mail]. The settings cannot be changed from this window.

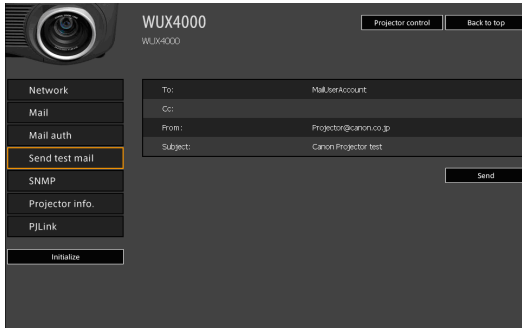

Item	Explanation
To:	The recipient address which was set from [Mail] in the settings window (P183) is displayed.
Cc:	The CC address which was set from [Mail] in the settings window (P183) is displayed.
From:	The sender name which was set from [Mail] in the settings window (P183) is displayed.
Subject:	The predetermined mail title "Canon Projector test" is displayed.

■ SNMP Settings [SNMP]

From [SNMP] in the settings window, you can configure the settings related to control of projectors which use SNMP (Simple Network Management Protocol). For the setting procedure, refer to [page 177](#).

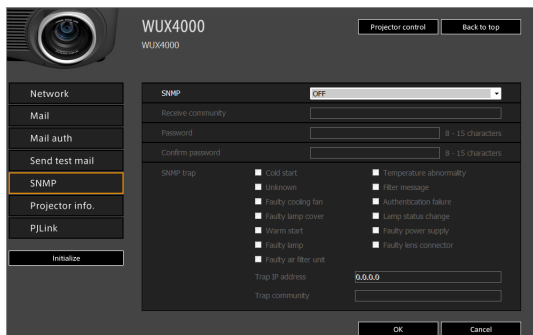

Setting Up the Network

Item	Explanation	Factory default setting
SNMP	Select the SNMP function version. If OFF is selected, the SNMP function will be turned off and the other settings in this window cannot be changed.	OFF
Receive community	Enter the community name which will receive projector information in 1-byte alphanumeric characters and symbols (1 - 15 characters).	<Blank>
Password	Enter the community settings password in 1-byte alphanumeric characters and symbols (8 - 15 characters). This is also used as the password for trapping. It can be set only when the SNMP version is V3.	<Blank>
Confirm password	For confirmation, enter the same password as you entered in [Password].	<Blank>
SNMP trap	Select the type of error to trap. When any of the checkboxes is turned on, it becomes possible to set [Trap IP address] and [Trap community].	OFF (no checkmarks)
Trap IP address	Enter the IP address to send information to when trap occurs. Enter in 1-byte numbers.	0.0.0.0
Trap community	Enter the community name which will send information when trap occurs. Enter in 1-byte alphanumeric characters and symbols (1 - 15 characters).	<Blank>

■ Setting Projector Information [Projector info.]

From [Projector info.] in the settings window, you can set the names and location names which are used to identify projectors when multiple projectors are installed on the network. For the setting procedure, refer to [page 177](#).

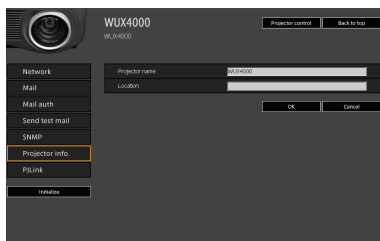

Item	Explanation	Factory default setting
Projector name	Enter the projector name in 1-byte alphanumeric characters and symbols (1 - 63 characters).	WUX5000 / WUX4000 / WX6000 / SX6000
Location	Enter the projector installation location in 1-byte alphanumeric characters and symbols (0 - 63 characters).	<Blank>

■ Setting PJLink [PJLink]

From [PJLink] in the setting window, you can set the PJLink functions which are the standard for projector management on a network. For the setting procedure, refer to [page 177](#). For information about PJLink, refer to [page 174](#).

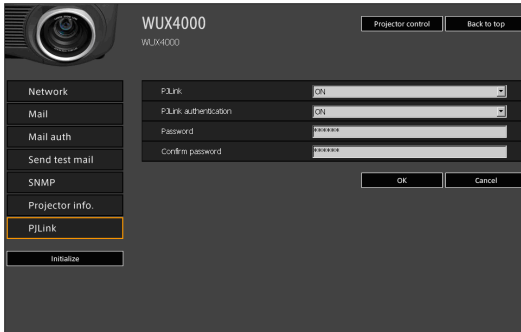

Item	Explanation	Factory default setting
PJLink	Turn the PJLink function on or off. If OFF is selected, the PJLink function will be turned off and the other settings in this window cannot be changed.	ON
PJLink authentication	Select whether to turn the PJLink authentication function on or off. If OFF is selected, [Password] and [Confirm password] cannot be changed.	ON
Password	Enter the PJLink authentication password in 1-byte alphanumeric characters (1 - 32 characters).	system
Confirm password	For confirmation, enter the same password that you entered in [Password].	system

Controlling the Projector from a Computer

When the projector is connected to a network, it is possible to control the projector from a computer via the network.

- 1** Turn on the computer and projector.
- 2** Launch a web browser, enter “http://(projector IP address)” in the address bar, and press the Enter key.
The password input screen appears.
The factory default IP address is “192.168.254.254”. It is possible to check the IP address from the projector menu.
- 3** Enter the user name and password on the password input screen, then click OK.
The factory default user name is “root” and the password is “system”.

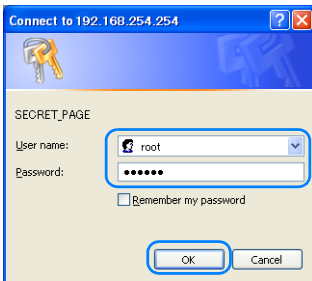

- 4** The projector web screen appears in the web browser. Click [Projector control].

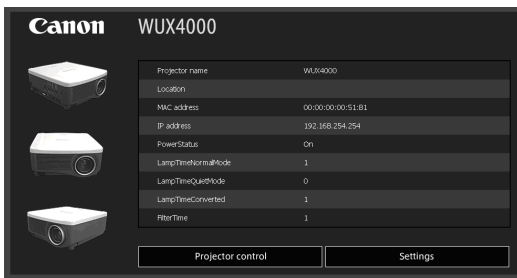

Controlling the Projector from a Computer

- 5** The projector control screen appears. The projector can be controlled from this screen.

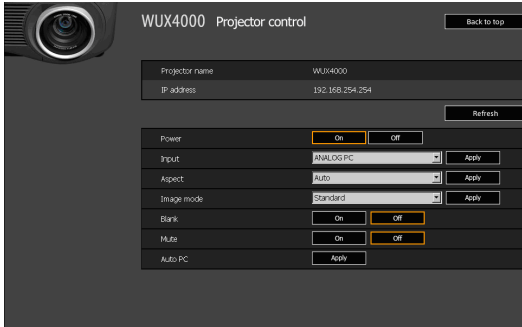

Item	Explanation
Projector name	The name of the connected projector is displayed. (P186)
IP address	The IP address of the connected projector is displayed. (P182)
Refresh	Refreshes the displayed contents with the most recent information.
Power	Turns projector power on or off.
Input	Select an input signal and click [Apply] to change to that input signal. (P59)
Aspect	Select an aspect and click [Apply] to change to that aspect. (P69)
Image mode	Select an image mode and click [Apply] to change to that image mode. (P78)
Blank	Switches the blank setting on or off. (P82)
Mute	Switches the mute setting on or off. (P83)
Auto PC	Performs Auto PC. (P62)
Information	The control results and control error information are displayed at the top of the screen.

- 6** When the operations are finished, click [Back to top] to return the initial web screen.

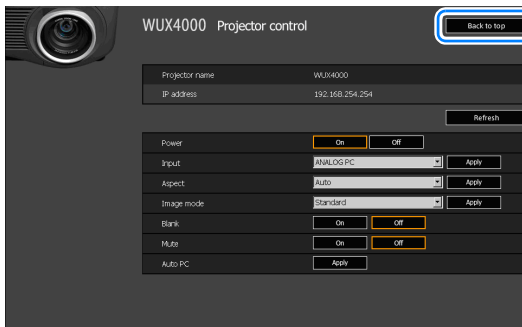

Error Mail

The messages shown in the following error list are sent when an error occurs in the projector.

Error list

Errors related to temperature	Error name	Temperature abnormality
	Text	The temperature inside the projector is too high for some reason or the outside air temperature is higher than the specified one. If the problem is inside the projector, check whether the projector is installed and operated normally, turn off the projector to cool its inside, and retry projection. If the same warning occurs again, the projector may be defective. Contact your dealer.
Errors related to the lamp	Error name	Faulty lamp
	Text	The lamp has burnt out. Replace the lamp with a new one. If the same warning occurs again, the lamp drive circuit may be defective. Contact your dealer.
Errors related to the lamp cover	Error name	Faulty lamp cover
	Text	The lamp cover is open. Check whether the lamp cover is installed properly. If it is installed properly, the lamp cover detection switch may be defective. Contact your dealer.
Errors related to the cooling fan	Error name	Faulty cooling fan
	Text	The cooling fan or another component may be defective. Contact your dealer.
Errors related to the power supply	Error name	Faulty power supply
	Text	The voltage of part of the power supply is abnormally high or any other problem has occurred in the power supply. Contact your dealer.
Errors related to the lens connector	Error name	Faulty lens connector
	Text	The lens cable is not connected to the lens unit. Check whether the lens cable is connected to the lens unit properly. If it is connected properly, the lens connector or cable may be defective. Contact your dealer.
Errors related to the air filter	Error name	Faulty air filter unit
	Text	The air filter unit is not installed properly. Check whether the air filter unit is installed properly. If it is installed properly, the air filter unit detection switch may be defective. Contact your dealer.
Other types of errors	Error name	Unknown Error
	Text	Code in hexadecimal numbers*

* For details, contact the Canon Customer Support Center.

Maintenance

Table of Contents

Safety Instructions

Before Use

Projecting an Image

Useful Functions Available
During a Presentation

Setting Functions from Menus

Installation

Connecting to a Network

Maintenance

Appendix

Index

User's Manual

Installation Manual

Appendix

Cleaning the Projector

Clean the projector frequently to prevent dust from settling on the surface. A dirty lens may ruin the quality of the projected image.



When cleaning the projector, make sure to turn off the projector, wait until the cooling fan stops, disconnect the power plug from the electrical outlet, and let the projector stand for at least 1 hour. Otherwise, you may get burned because the main unit is very hot immediately after the projector is turned off.

Wipe the projector's main unit softly with a soft cloth.

If the projector is heavily soiled, soak the cloth in water with a small amount of detergent in it, squeeze the cloth thoroughly, and then wipe the projector with it. After cleaning, wipe the projector with a dry cloth.



- Never use volatile cleaning liquid or benzene, as these may damage the finish of the projector.
- When using a chemical dust cloth, make sure to read the instructions thoroughly.
- When cleaning the projector's lens, use a commonly available air blower or lens cleaning paper. The lens surface is easily damaged, so do not use a hard cloth or tissues.

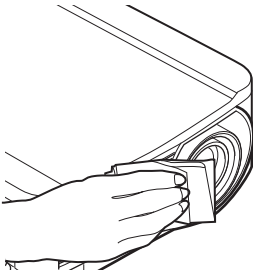

Cleaning and Replacing the Air Filter

Replacing the Air Filter

Follow the procedure below when replacing the air filter.

- 1** Turn off the projector power and remove the power plug.
- 2** Hook your finger onto the handle of the air filter on the side of the projector, and pull the air filter out to remove it.

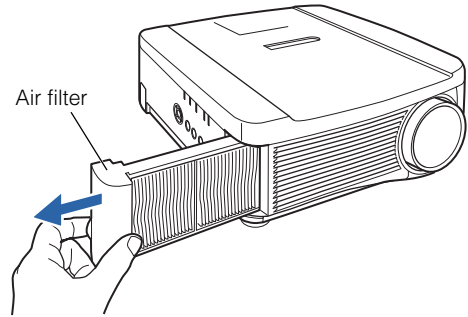

- 3** Remove the filter from the air filter frame. First disengage the tab on the inside, then remove the entire air filter from the frame.

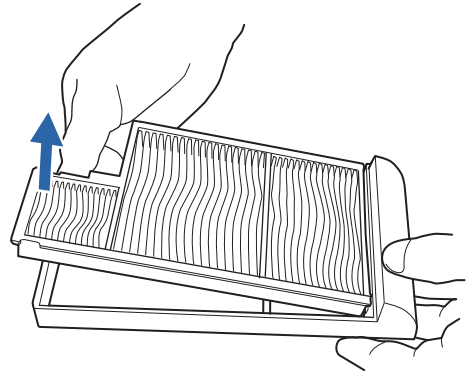

- 4** Install a new air filter into the frame. First insert the air filter tab into the groove on the handle side of the frame, then press the air filter into the frame.

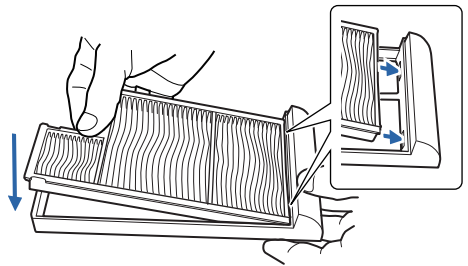

Cleaning and Replacing the Air Filter

- 5** Securely insert the air filter all the way into the projector.

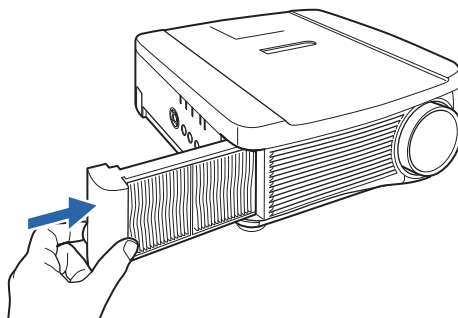

- Handle the air filter carefully. If damaged, the air filter will not work properly.
- When the lamp is replaced, it is recommended that you also replace the air filter.
- Contact the Canon Customer Support Center for further information.
- Replacement air filter part No.: RS-FL01
- This can also be purchased from the Canon home page (http://store.canon.jp/user/ListProducts/list?svid=2&sc=LMPPR&jsp=/jsp/search/search_item_acc.jsp).

Cleaning the Air Filter

The air filter protects the lens and mirror inside the projector from dust and dirt. Should the air filter become clogged with dust, the projector may be damaged since it will block the air flow into the projector and raise the internal temperature of the projector. The following screen is displayed when turning on the projector if the air filter needs to be cleaned (after approx. 300 hours). Clean the air filter if it is displayed.

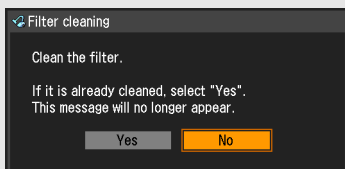

- Only the [◀], [▶], **OK** and **POWER** buttons are available while this screen is displayed. (When you press the **POWER** button, the message “Push **POWER** button again to turn off power” appears.)
- When this screen has disappeared after being displayed for 10 seconds, all buttons become operable.

- Turn the power of the projector off and pull out the power plug.
- Hook your finger into the air filter handle on the side of the projector, and remove the air filter. Then use a vacuum cleaner to remove the dust.
- If the filter replacement screen is displayed when turning on the projector after cleaning the air filter, select [Yes] and press **OK**. The filter replacement screen will disappear.
- This screen is not displayed when [Filter warning display] is set to [Off]. (WX6000 / SX6000) (P137)

Replacing the Lamp

When the usage time of the lamp exceeds a certain amount of time, the following message (two types) is displayed for 10 seconds every time the projector is turned on.

2,700 hours to less than 3,000 hours



Prepare a new lamp when this screen is displayed.

- Only the [◀], [▶], **OK** and **POWER** buttons are available while this screen is displayed.
- When you press the **POWER** button, "Push **POWER** button again to turn off power." message appears.
- After this screen has been displayed for 10 seconds and disappeared, all buttons become operable.
- This message will not be displayed again if you select [Cancel] in response to the message "Do you want to display this message again?".

3,000 hours or more

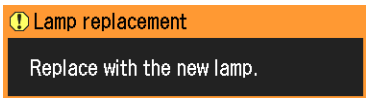

If this screen is displayed, replace the lamp by referring to the procedure on [page 196](#).

- Only the **POWER** button is available while this screen is displayed.
- When you press the **POWER** button, the "Push **POWER** button again to turn off power." message appears.
- When this screen has disappeared after being displayed for 10 seconds, all buttons become operable.
- You can check the usage time of the lamp in [Lamp counter] in the [System settings] menu. (P135)
- This screen is not displayed when [Lamp warning display] is set to [Off]. (WX6000 / SX6000) (P135)

Replacing the Lamp

Replacement Lamp

This projector uses the following lamps.

Lamp part No.: RS-LP06 (WUX4000)

RS-LP07 (WUX5000 / WX6000 / SX6000)

Contact the Canon Customer Support Center when purchasing a replacement lamp.



Caution

When replacing the lamp, turn off the projector, wait until the cooling fan stops, disconnect the power plug from the electrical outlet, and let the projector stand for at least 1 hour. Otherwise, you may get burned because the main unit is very hot immediately after the projector is turned off.



Caution

- Be sure to use the specified lamp.
- Contact the Canon Customer Support Center or access to the Canon home page.
- Do not touch the inner glass surface when you replace the lamp. Doing so may cause deterioration to the projector's performance.
- Be sure to handle the lamp carefully and correctly since it may break during use if it has been scratched or subjected to impact. If the lamp breaks, contact the Canon Customer Support Center or follow the instructions on [page 21](#) and [page 22](#).
- When replacing the lamp, do not remove any screws other than those specified.

Replacing the Lamp

1 Turn off the projector power and remove the power plug.

2 Loosen one screw and open the lamp cover in the direction of the arrow.
The lamp cover screw is attached to the lamp cover and designed to prevent it from falling off.

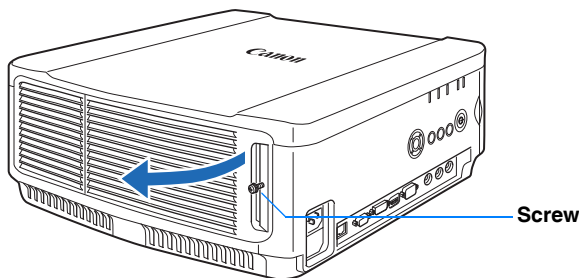

- 3** Loosen the 3 screws on the inside of the lamp unit, then slowly pull out the lamp unit in the direction of the arrow.

Even when the screws are loosened, they will not fall off the lamp unit.

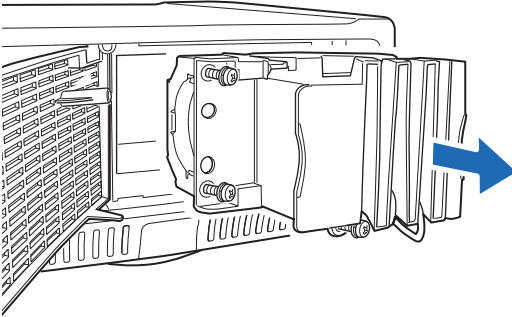

- 4** Fully insert a new lamp unit and secure it with the 3 screws.

- 5** Close the lamp cover and tighten the screws.

- 6** Turn on the power. Bring up the menu and select [System settings] - [Other settings] - [Lamp counter].

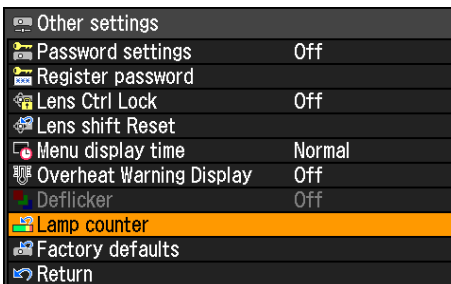
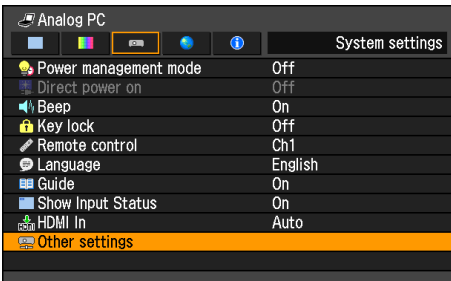

(The screen is for the WUX5000 / WUX4000.)

Replacing the Lamp

- 7 Select [Reset] - [OK] to reset the lamp counter.

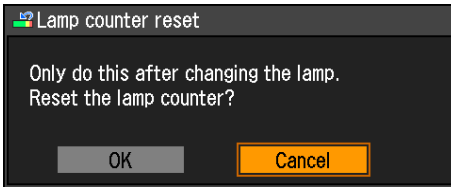
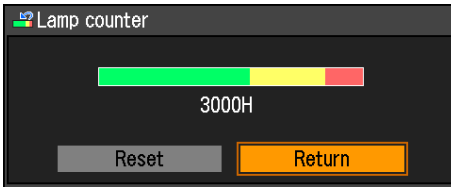

(The screen is for the WUX5000 / WUX4000.)



- It is recommended that you also replace the air filter when you replace the lamp.
- Contact the Canon Customer Support Center for further information.
- Replacement air filter product number: RS-FL01

MULTIMEDIA PROJECTOR

WUX5000

WUX4000

WX6000

SX6000

Appendix



Appendix

Table of Contents

Safety Instructions

Before Use

Projecting an Image

Useful Functions Available
During a Presentation

Setting Functions from Menus

Installation

Connecting to a Network

Maintenance

Appendix

Index

User's Manual

Installation Manual

Appendix

Troubleshooting

LED Indicator Meanings

When there is a problem with the projector, the LED indicator on the side of the projector illuminates or flashes continuously after the projector is turned off.

- Wait until the cooling fan stops and disconnect the power plug from the electrical outlet before dealing with the problem.

LED indicator status	Meaning	Countermeasure
WARNING and TEMP are lit.	Temperature abnormality	The temperature inside the projector is too high for some reason or the outside air temperature is higher than the operating range. If the problem is inside the projector, check whether the projector is installed and operating normally, unplug the projector from the power outlet to cool down the projector interior and then restart projection. If the air intake or exhaust vent is blocked, remove the obstacle. If the same warning occurs again, there may be a malfunction in the projector. Contact the Canon Customer Support Center.
WARNING and LAMP are lit.	Faulty lamp	The lamp does not illuminate. Turn the power off and then back on and check whether or not the lamp illuminates. Also, check whether the air intake or exhaust vent is blocked, and whether the air filter is clogged with dust. The warning may indicate if the air flow in and out of the projector is blocked, or if the internal temperature of the projector rises. If the air filter is clogged, clean or replace the air filter. (P193, P194) If the lamp does not illuminate, replace it. If the same warning occurs again, there may be a malfunction in the lamp drive circuit. Contact the Canon Customer Support Center.
WARNING flashes 3 times, LAMP is lit.	Faulty lamp cover	The lamp cover is open. Unplug the projector from the electrical outlet, then install the lamp cover correctly and turn on the projector again. If the lamp cover has been installed properly, there may be a malfunction in the lamp cover detection switch. Contact the Canon Customer Support Center.
WARNING (only) flashes 4 times repeatedly.	Faulty cooling fan	There may be a malfunction in the cooling fan or another component. Unplug the projector from the electrical outlet, then plug it into the outlet and turn on the projector again. Contact the Canon Customer Support Center if the same warning occurs again.
WARNING (only) flashes 5 times repeatedly.	Faulty power supply	Abnormal voltage is applied to some parts in the power supply or another failure may have occurred. Unplug the projector from the electrical outlet, then plug it back into the outlet and turn on the projector again. Contact the Canon Customer Support Center if the same warning occurs again.

LED indicator status	Meaning	Countermeasure
WARNING (only) flashes 6 times repeatedly.	Faulty lens connector	Disconnect the lens connector which joins the lens unit and projector. Contact the Canon Customer Support Center.
WARNING (only) flashes 3 times repeatedly.	Filter error	The air filter is not installed. Check whether or not the air filter is installed correctly. Contact the Canon Customer Support Center if the same warning occurs again.

Symptoms and Solutions

■ You Cannot Turn on the Projector

Cause	Countermeasure
The power cord is not connected correctly.	Check whether the power cord is connected correctly. (P56)
The power cord has just been connected.	You cannot turn on the projector until the [STAND BY] indicator turns red after connecting the power plug. (P56)
The lamp cover is open.	Unplug the projector from the power outlet, then install the lamp cover correctly and turn on the projector again.
The safety device is activated because the air intake or the exhaust vent is blocked and the internal temperature of the projector has increased.	When the safety device is active, the [STAND BY] indicator does not turn on when you connect the power cord. You cannot disable this safety device. Remove any obstacle that is blocking the air intake or exhaust vent and contact the Canon Customer Support Center.
The lens connector is not connected correctly.	The lens connector that connects the lens unit with the main unit of the projector is disconnected. Contact the Canon Customer Services Center.
The air filter is not installed correctly.	Check whether the air filter is installed correctly. (P193)
Key lock is enabled.	Check that Key lock (P123) is not enabled for the projector or the remote control.

■ You Cannot Project an Image from the Projector

Cause	Countermeasure
A cable is not connected correctly.	Check whether the projector is connected to the computer or AV equipment correctly. (P52, P59)
20 seconds have not elapsed since the projector was turned on.	When the projector is turned on, the opening window is displayed for approximately 20 seconds. To project an image immediately, press the OK button on the remote control or side control. (P56)
No image is sent from the AV equipment.	Check whether an image is played on the connected video camcorder, DVD, etc.

Troubleshooting

Cause	Countermeasure
Connection with the input terminal has not been performed correctly.	Check whether the AV equipment is connected to the projector input terminal correctly. (P47)
No input signal type has been selected for the connected AV equipment.	Check that the same input signal has been correctly selected for the connected AV equipment from the [INPUT] menu. (P60)
The input signal type is incorrect.	Check whether the selected input signal type is correct. (P94, P218)
The BLANK function has been selected.	Press the BLANK button on the remote control. (P82)
No image is projected due to a problem with the computer.	Turn first the projector and then the computer off and then back on again.
The external monitor output is not set on the notebook computer correctly.	Turn on the external monitor output on the notebook computer. To turn on the external monitor output, press the [LCD] or [VGA] function key or a key with an icon for the external monitor, while holding down the [Fn] key on the keyboard of the notebook computer. With Windows 7, you can turn on image output by holding down the Windows logo key and pressing the [P] key. (P58) The combination of keys used to perform this operation varies depending on the model of notebook computer. For more detailed information, refer to the manual that came with your computer.
The displayed image is not the same as that displayed on the computer.	Check whether the dual screen (multi-display) mode is selected on the computer. If the dual screen mode has been selected, change it to the simultaneous display mode on the computer. The output setting method varies among computer manufacturers. For more detailed information, refer to the manual that came with your computer.

■ There is no Sound

Cause	Countermeasure
The audio cable is not connected correctly.	Check the audio cable connection. (P162)
The MUTE function is enabled.	Press the MUTE button on the remote control. (P83)
The volume level is adjusted to the minimum.	Press the VOL button on the remote control or the VOL+ button on the side control to adjust the volume level. (P83)
An audio cable with a built-in resistor is used.	Use an audio cable without a built-in resistor.
Audio in terminal select is [Off] (WX6000 / SX6000).	Change the Audio In terminal to the appropriate setting. (P139)

■ The Projected Image Is Blurred

Cause	Countermeasure
The image is out of focus.	Adjust the focus. (P73)
The distance to the screen is too short.	Check whether the distance to the screen is appropriate. If the distance is shorter than approximately 1.3 m (4.3'), the projector cannot focus on the screen. (P156)
The projector is not placed straight in front of the screen.	Check whether the projector is placed obliquely to the screen. A slight error in the projection angle can be corrected through the keystone adjustment function. (P76)
The projector has been moved to a place where the temperature varies a lot.	When the projector is moved from a location where the temperature is low to a location where the temperature is high, condensation may form on the lens. The condensation will evaporate after a period of time and the projector will be able to project a normal image.
The lens is stained.	Clean the lens. (P192)
The tracking is bad.	Adjust the tracking with the [AUTO PC] or [Tracking] function. (P62, P96)

■ You Cannot Project an Image Appropriately

Cause	Countermeasure
The projected image is inverted in the vertical or horizontal direction.	The ceiling mounted / rear projection setting is incorrect. Check the [Image flip H/V] setting in the [Display settings] menu. (P104)
The dot clock of the input signal is higher than 162 MHz with a BNC cable.	Set the signal dot clock to 162 MHz or less on your computer.
A VGA cable is used in which some pins are not connected.	Use a VGA cable in which all pins are connected.

■ The Projector Power Turns Off

Cause	Countermeasure
The air intake or exhaust vent is blocked.	Check whether the air intake or exhaust vent is blocked. If the air intake or exhaust vent is blocked, the temperature inside the projector will increase and the power is automatically turned off to protect the projector. (The [WARNING] indicator and [TEMP] indicator are lit.) Wait until the projector temperature drops, then make sure that the intake and exhaust vents are not blocked and turn on the projector. (P32, P56)
The air filter is dirty.	Check whether the air filter is clogged with dust. If the air filter is clogged, clean or replace the air filter. (P193)

Troubleshooting

Cause	Countermeasure
The lamp has broken (or there is a lamp malfunction).	Check whether the lamp has broken. If the lamp has broken, follow the instructions on page 21 . If the lamp has not broken, there may be a malfunction with the lamp. Check the lamp by replacing it with a spare lamp if you have one. (P22 , P195 , P196)
The operating temperature is inappropriate.	Check whether the operating temperature is between 5°C and 35°C. (P24) If you use the projector at 2300 m or higher above sea level, contact the Canon Customer Support Center.

■ You Cannot Operate the Remote Control

Cause	Countermeasure
Batteries are not installed properly or they have run out.	Check whether batteries are installed correctly. If batteries are installed correctly, replace them with new batteries. (P27)
You are operating the remote control from the outside of the remote control operating range.	Check whether you are operating the remote control within the remote control operating range of the main unit of the projector. (P29)
There is an obstacle between the projector and the remote control.	Remove the obstacle between the infrared remote receiver of the main unit of the projector and the remote control or point the remote control in an obstacle-free path.
You are operating the remote control in an unsuitable operating environment.	Check whether the infrared remote receiver of the main unit of the projector is exposed to direct sunlight or strong light of lighting apparatus. (P29)
The channel setting of the remote control does not match the setting of the projector.	Check whether the channel setting of the remote control has been changed. You can check the [Remote control] setting in the [System settings] menu. (P124)
The key lock function is preventing operation of the remote control.	Check whether [Key lock] is enabled to disable the remote control operation. In the System settings menu, set [Key lock] to [Off]. (P123)
When using infrared operation, the cable is connected to the terminal for the wired remote control of the projector or remote control (WX6000 / SX6000).	Pull out the cable that is connected to the terminal for the wired remote control of the projector or remote control. (P30)
When using with the cable connected, the cable may not be connected to the terminal for the wired remote control of the projector or remote control (WX6000 / SX6000).	Check whether the cable is connected to the terminal for the wired remote control of the projector and remote control. Also check that the cable is not broken. (P30)

If the above causes cannot be identified, the projector may be damaged. Contact the Canon Customer Support Center as soon as possible.

Relationship between Aspect and Screen Aspect

This section describes the relationship between screen aspect (P63) and aspect (P69). To project an image on the whole screen, select the most appropriate screen aspect ratio and aspect according to the aspect ratio of the screen and input signal type.

- If an image from image software with an aspect ratio of 16:9 is not projected correctly, select [16:9] as the screen aspect.
- For a 16:9 image with black borders at the top and bottom, such as a terrestrial broadcast movie, you can project the 16:9 image area so that it is projected on the entire screen by selecting [Zoom] in [Aspect].

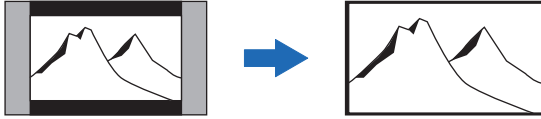

[Zoom] is available when [16:10], [16:9] or [16:9 D. image shift] is selected for the screen aspect and [HDMI (480p, 576p)] or [Component (480p, 480i, 576p, 576i)] is selected for the input signal.

- To perform keystone adjustment (P76), select [16:10], [4:3] or [16:9] for [Screen aspect].

WUX5000 / WUX4000

■ When the image is projected on a 16:10 screen



Aspect ratio of connected device	Screen aspect setting (P63)	Aspect setting (P69)	Screen image
(16:10) 1920 x 1200 1440 x 900 1280 x 800	[16:10]	[Full] [Auto]	
(16:9) 1920 x 1080 1280 x 720		[Full]	
(4:3) 1600 x 1200 1400 x 1050 640 x 480		[Full]	

Relationship between Aspect and Screen Aspect

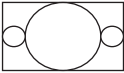
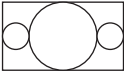
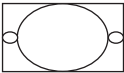
■ When the image is projected on a 16:9 screen

Aspect ratio of connected device	Screen aspect setting (P63)	Aspect setting (P69)	Screen image
(16:10) 1920 x 1200 1440 x 900 1280 x 800	[16:9] [16:9 D. image shift]	[16:9]	
(16:9) 1920 x 1080 1280 x 720		[16:9] [Auto]	
(4:3) 1600 x 1200 1400 x 1050 640 x 480		[16:9]	

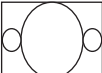
■ When the image is projected on a 4:3 screen

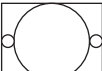
Aspect ratio of connected device	Screen aspect setting (P63)	Aspect setting (P69)	Screen image
(16:10) 1920 x 1200 1440 x 900 1280 x 800	[4:3] [4:3 D. image shift]	[4:3]	
(16:9) 1920 x 1080 1280 x 720		[4:3]	
(4:3) 1600 x 1200 1400 x 1050 640 x 480		[4:3] [Auto]	

Relationship between Aspect and Screen Aspect

■ When projecting on a 16:10 screen in the aspect ratio of the connected device

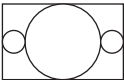
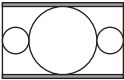
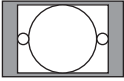
Aspect ratio of connected device	Screen aspect setting (P63)	Aspect setting (P69)	Screen image
(16:10) 1920 x 1200 1440 x 900 1280 x 800	[16:10]	[Full] [Auto]	
(16:9) 1920 x 1080 1280 x 720		[16:9] [Auto]	
(4:3) 1600 x 1200 1400 x 1050 640 x 480		[4:3] [Auto]	

■ When projecting on a 16:9 screen in the aspect ratio of the connected device

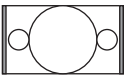
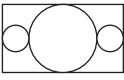
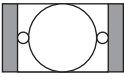
Aspect ratio of connected device	Screen aspect setting (P63)	Aspect setting (P69)	Screen image
(16:10) 1920 x 1200 1440 x 900 1280 x 800	[16:9] [16:9 D. image shift]	[Auto]	
(16:9) 1920 x 1080 1280 x 720		[16:9] [Auto]	
(4:3) 1600 x 1200 1400 x 1050 640 x 480		[4:3] [Auto]	

Relationship between Aspect and Screen Aspect

■ When projecting on a 4:3 screen in the aspect ratio of the connected device

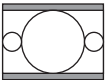
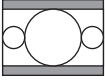
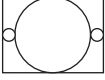
Aspect ratio of connected device	Screen aspect setting (P63)	Aspect setting (P69)	Screen image
(16:10) 1920 x 1200 1440 x 900 1280 x 800	[4:3] [4:3 D. image shift]	[Auto]	
(16:9) 1920 x 1080 1280 x 720		[16:9] [Auto]	
(4:3) 1600 x 1200 1400 x 1050 640 x 480		[4:3] [Auto]	

WX6000

■ When the image is projected on a 16:10 screen

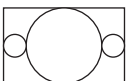
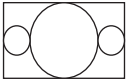
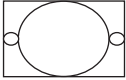

Aspect ratio of connected device	Screen aspect setting (P63)	Aspect setting (P69)	Screen image
(16:10) 1920 x 1200 1440 x 900 1280 x 800	[16:10]	[16:10] [Auto]	
(16:9) 1920 x 1080 1280 x 720		[16:10]	
(4:3) 1600 x 1200 1400 x 1050 640 x 480		[16:10]	

Relationship between Aspect and Screen Aspect

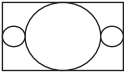
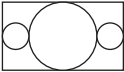
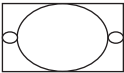
■ When the image is projected on a 16:9 screen

Aspect ratio of connected device	Screen aspect setting (P63)	Aspect setting (P69)	Screen image
(16:10) 1920 x 1200 1440 x 900 1280 x 800	[16:9] [16:9 D. image shift]	[16:9]	
(16:9) 1920 x 1080 1280 x 720		[16:9] [Auto]	
(4:3) 1600 x 1200 1400 x 1050 640 x 480		[16:9]	

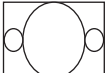
■ When the image is projected on a 4:3 screen

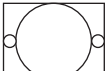
Aspect ratio of connected device	Screen aspect setting (P63)	Aspect setting (P69)	Screen image
(16:10) 1920 x 1200 1440 x 900 1280 x 800	[4:3] [4:3 D. image shift]	[4:3]	
(16:9) 1920 x 1080 1280 x 720		[4:3]	
(4:3) 1600 x 1200 1400 x 1050 640 x 480		[4:3] [Auto]	

Relationship between Aspect and Screen Aspect

■ When projecting on a 16:10 screen in the aspect ratio of the connected device

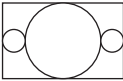
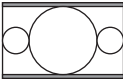
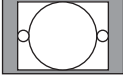
Aspect ratio of connected device	Screen aspect setting (P63)	Aspect setting (P69)	Screen image
(16:10) 1920 x 1200 1440 x 900 1280 x 800	[16:10]	[16:10] [Auto]	
(16:9) 1920 x 1080 1280 x 720		[16:9] [Auto]	
(4:3) 1600 x 1200 1400 x 1050 640 x 480		[4:3] [Auto]	

■ When projecting on a 16:9 screen in the aspect ratio of the connected device

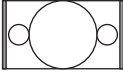
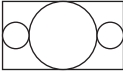
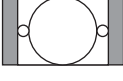
Aspect ratio of connected device	Screen aspect setting (P63)	Aspect setting (P69)	Screen image
(16:10) 1920 x 1200 1440 x 900 1280 x 800	[16:9] [16:9 D. image shift]	[16:10] [Auto]	
(16:9) 1920 x 1080 1280 x 720		[16:9] [Auto]	
(4:3) 1600 x 1200 1400 x 1050 640 x 480		[4:3] [Auto]	

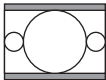
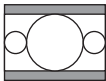
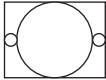

Relationship between Aspect and Screen Aspect

■ When projecting on a 4:3 screen in the aspect ratio of the connected device

Aspect ratio of connected device	Screen aspect setting (P63)	Aspect setting (P69)	Screen image
(16:10) 1920 x 1200 1440 x 900 1280 x 800	[4:3] [4:3 D. image shift]	[16:10] [Auto]	
(16:9) 1920 x 1080 1280 x 720		[16:9] [Auto]	
(4:3) 1600 x 1200 1400 x 1050 640 x 480		[4:3] [Auto]	

SX6000

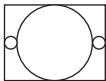
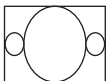
■ When the image is projected on a 4:3 screen

Aspect ratio of connected device	Screen aspect setting (P63)	Aspect setting (P69)	Screen image
(4:3) 1600 x 1200 1400 x 1050 640 x 480	[4:3]	[4:3] [Auto]	
(16:10) 1920 x 1200 1440 x 900 1280 x 800		[4:3]	
(16:9) 1920 x 1080 1280 x 720		[4:3]	

Relationship between Aspect and Screen Aspect

■ When the image is projected on a 16:10 screen

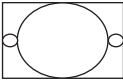
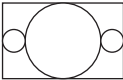
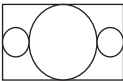
Aspect ratio of connected device	Screen aspect setting (P63)	Aspect setting (P69)	Screen image
(4:3) 1600 x 1200 1400 x 1050 640 x 480	[16:10] [16:10 D. image shift]	[16:10]	
(16:10) 1920 x 1200 1440 x 900 1280 x 800		[16:10] [Auto]	
(16:9) 1920 x 1080 1280 x 720		[16:10]	

■ When the image is projected on a 16:9 screen

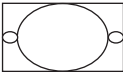
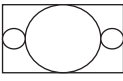
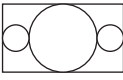
Aspect ratio of connected device	Screen aspect setting (P63)	Aspect setting (P69)	Screen image
(4:3) 1600 x 1200 1400 x 1050 640 x 480	[16:9] [16:9 D. image shift]	[16:9]	
(16:10) 1920 x 1200 1440 x 900 1280 x 800		[16:9]	
(16:9) 1920 x 1080 1280 x 720		[16:9] [Auto]	

Relationship between Aspect and Screen Aspect

■ When projecting on a 4:3 screen in the aspect ratio of the connected device

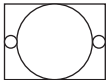
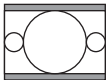
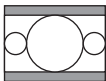
Aspect ratio of connected device	Screen aspect setting (P63)	Aspect setting (P69)	Screen image
(4:3) 1600 x 1200 1400 x 1050 640 x 480	[4:3]	[4:3] [Auto]	
(16:10) 1920 x 1200 1440 x 900 1280 x 800		[16:10] [Auto]	
(16:9) 1920 x 1080 1280 x 720		[10:9] [Auto]	

■ When projecting on a 16:10 screen in the aspect ratio of the connected device

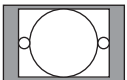
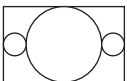
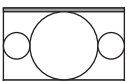
Aspect ratio of connected device	Screen aspect setting (P63)	Aspect setting (P69)	Screen image
(4:3) 1600 x 1200 1400 x 1050 640 x 480	[16:10] [16:10 D. image shift]	[4:3] [Auto]	
(16:10) 1920 x 1200 1440 x 900 1280 x 800		[16:10] [Auto]	
(16:9) 1920 x 1080 1280 x 720		[10:9] [Auto]	

Relationship between Aspect and Screen Aspect

■ When projecting on a 16:9 screen in the aspect ratio of the connected device

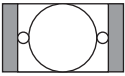
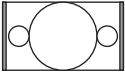
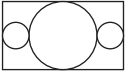
Aspect ratio of connected device	Screen aspect setting (P63)	Aspect setting (P69)	Screen image
(4:3) 1600 x 1200 1400 x 1050 640 x 480	[16:9] [16:9 D. image shift]	[4:3] [Auto]	
(16:10) 1920 x 1200 1440 x 900 1280 x 800		[16:10] [Auto]	
(16:9) 1920 x 1080 1280 x 720		[16:9] [Auto]	

Displayed Test Patterns

If using WX6000 / SX6000

The test pattern can be displayed by pressing the [TEST PATTERN] button. Use this when there is no image signal, etc.

While the test pattern is displayed, you can use the [▲] / [▼] buttons to change to a different test pattern. Also, if there is an option pattern available, you can use the [◀] / [▶] buttons to switch pattern.

The following test patterns can be displayed.

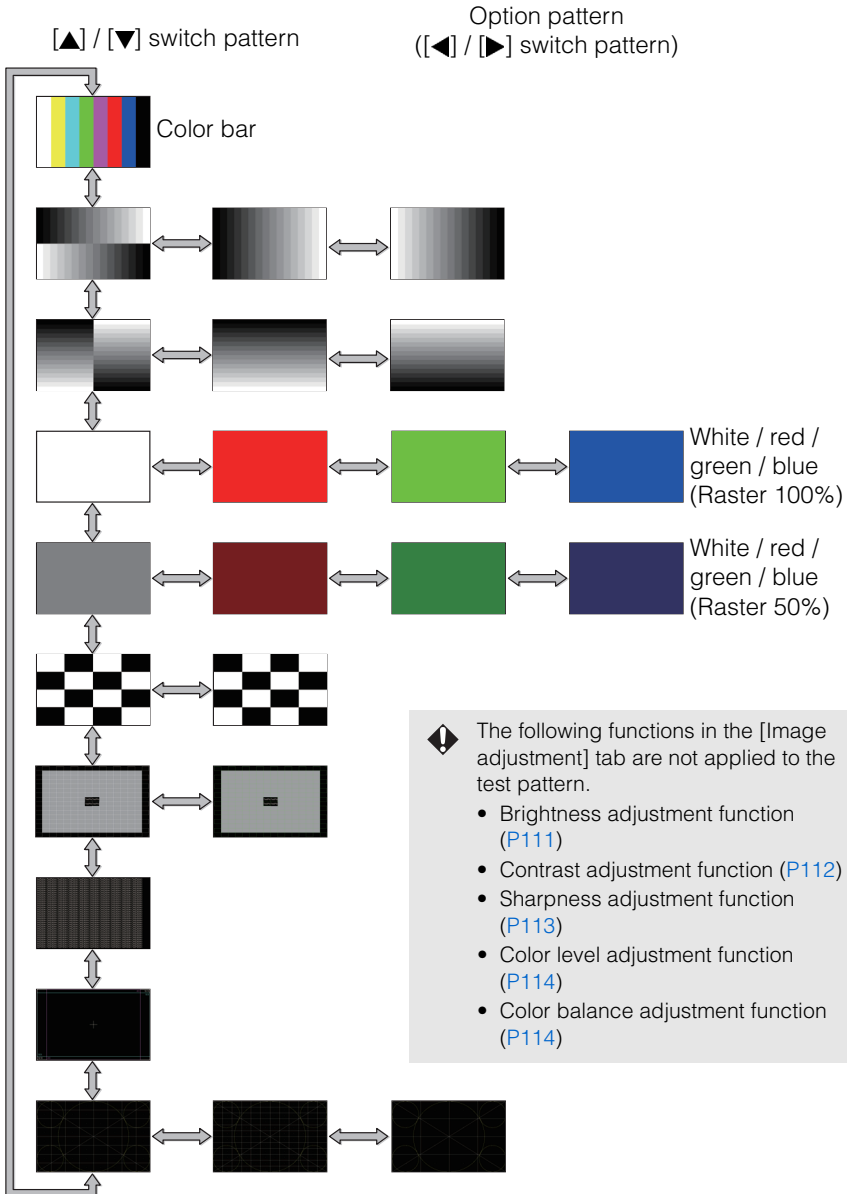

Supported Signal Types

This projector supports the following signal types.

If your computer or AV equipment is compatible with any one of these signal types, the projector's Auto PC function selects the input signal type to project an image appropriately.

ANALOG RGB

Resolution (dots)	Signal type	Horizontal frequency (kHz)	Vertical frequency (Hz)
640 x 480	VGA	31.469	59.940
720 x 480	-	31.469	59.940
720 x 576	-	31.250	50.000
800 x 600	SVGA	37.879	60.317
848 x 480	-	31.020	60.000
1024 x 768	XGA	48.363	60.004
1280 x 720	-	37.500	50.000
		45.000	60.000
1280 x 768	WXGA	47.776	59.870
		47.396	59.995
		49.702	59.810
1280 x 800	-	49.306	59.910
1280 x 960	MAC	60.000	60.000
1280 x 1024	SXGA	63.981	60.020
1360 x 768	-	47.712	60.015
1366 x 768	-	47.712	59.790
1400 x 1050	SXGA+	64.744	59.948
		65.317	59.978
1440 x 900	WXGA+	55.935	59.887
		55.469	59.901
1600 x 1200	UXGA	75.000	60.000
1680 x 1050	WSXGA+	64.674	59.883
		65.290	59.954
1920 x 1080	-	56.250	50.000
		67.500	60.000
1920 x 1200 (WUX5000 / WUX4000)	WUXGA	74.038	59.950

DVI

Resolution (dots)	Signal type	Horizontal frequency (kHz)	Vertical frequency (Hz)
640 x 480	D-VGA	31.469	59.940
720 x 480	-	31.469	59.940
720 x 576	-	31.250	50.000
800 x 600	D-SVGA	37.879	60.317
1024 x 768	D-XGA	48.363	60.004
1280 x 720	-	37.500	50.000
		45.000	60.000
1280 x 800	D-WXGA	49.702	59.810
		49.306	59.910
1280 x 1024	D-SXGA	63.981	60.020
1400 x 1050	D-SXGA+	64.744	59.948
		65.317	59.978
1440 x 900	D-WXGA+	55.935	59.887
		55.469	59.901
1600 x 1200	D-UXGA	75.000	60.000
1680 x 1050	D-WSXGA+	64.674	59.883
		65.290	59.954
1920 x 1080	-	56.250	50.000
		67.500	60.000
1920 x 1200 (WUX5000 / WUX4000)	D-WUXGA	74.038	59.950

- * The specifications in the table above are subject to change without notice.
- * This projector does not support any computer output signal with a dot clock of higher than 162 MHz.
- * Use a VGA cable in which all pins are connected. If the cable is a type in which all pins are not connected, the image may not be correctly displayed.

HDMI

Connecting to a computer

Resolution (dots)	Signal type	Horizontal frequency (kHz)	Vertical frequency (Hz)
640 x 480	VGA	31.469	59.940
800 x 600	SVGA	37.879	60.317
1024 x 768	XGA	48.363	60.004
1280 x 800	WXGA	49.702	59.810
		49.306	59.910
1280 x 1024	SXGA	63.981	60.020
1400 x 1050	SXGA+	64.744	59.948
		65.317	59.978
1440 x 900	WXGA+	55.935	59.887
		55.469	59.901
1600 x 1200	UXGA	75.000	60.000
1680 x 1050	WSXGA+	64.674	59.883
		65.290	59.954
1920 x 1200 (WUX5000 / WUX4000)	WUXGA	74.038	59.950

Connecting with AV equipment

Signal type	Horizontal frequency (kHz)	Vertical frequency (Hz)
480p	31.469	59.940
576p	31.250	50.000
720p	37.500	50.000
	45.000	60.000
1080i	28.125	50.000
	33.750	60.000
1080p	56.250	50.000
	67.500	60.000

COMPONENT

Signal type	Horizontal frequency (kHz)	Vertical frequency (Hz)
480i	15.734	59.940
480p	31.469	59.940
576i	15.625	50.000
576p	31.250	50.000
720p	37.500	50.000
720p	45.000	60.000
1080i	28.125	50.000
1080i	33.750	60.000
1080p	56.250	50.000
1080p	67.500	60.000

Product Specifications

■ Projector

WUX5000 / WUX4000

Model name		WUX5000	WUX4000
Display system		RGB liquid crystal system	
Optical system		Color separation by dichroic mirror / polarizing beam splitter and color composition by prism	
Display device	Type	Reflective liquid crystal panel	
	Size / Aspect ratio	0.71" X3 / 16:10	
	Drive system	Active matrix system	
	Number dots / Total number dots	2,304,000 (1920 x 1200) x 3 panels / 6,912,000	
Projection lens(*1)	Zoom ratio / Focal length / F value	1.5x / f = 23.0 - 34.5 mm / F1.89 - F2.65	
	Zooming / Focusing system	Electric / Electric	
	Lens shift	V: -15% - +55%, H: ±10%	
Light source		330-NSHA 336 W	310-NSHA 300 / 264 W (lamp mode Normal / Quiet)
Image size (projection distance) (*1)		Size 40 to 600 (1.3 m / 4.6' to 29.0 m / 95.1')	
Number of colors		16,770,000 colors (full color)	
Brightness (*1)		5,000 lumen	4,000 lumen (*2)
Contrast ratio		1000:1 (Full white: Full black, during presentation)	
Ratio of brightness at periphery to center (*1)		88%	
Speaker		5W monaural x 1	
Maximum input resolution		1920 x 1200 dots	
Video signals	Analog PC input	WUXGA / UXGA / WSXGA+ / SXGA+ / WXGA+ / SXGA / WXGA / XGA / SVGA / VGA (Scan frequency: Horizontal 15 - 75 kHz, Vertical 50 - 85 Hz)	
	Digital PC input	WUXGA / UXGA / WSXGA+ / SXGA+ / WXGA+ / SXGA / WXGA / XGA / SVGA / VGA	
	Component input	1080p, 1080i, 720p, 576i, 576p, 480i, 480p	
	HDMI input	1080p, 1080i, 720p, 576p, 480p	
Input terminal	DVI-D IN terminal	Digital PC (24-pin DVI connector)	
	HDMI IN terminal	HDMI (deep color)	
	ANALOG PC / COMPONENT IN terminal	Analog PC, Component (mini D-sub 15-pin)	
	CONTROL terminal	RS-232C (D-sub 9-pin)	
	AUDIO IN Terminal	Audio signal (3.5Ø stereo mini jack x 2)	
AUDIO OUT Terminal		Audio signal (3.5Ø stereo mini jack)	
LAN terminal		Network connection (RJ-45)	
Input signal	Digital PC	TMDS (Transition Minimized Differential Signaling)	
	Analog PC	0.7Vp-p, positive polarity, impedance = 75Ω Horizontal / vertical synchronization: TTL level, negative or positive polarity Composite synchronization in G signal: 0.3Vp-p, negative polarity, impedance = 75Ω	
	Component video	COMPONENT: Separate Y Cb/Pb Cr/Pr signal Y: 1Vp-p, negative synchronization, impedance = 75Ω Cb/Pb: 0.7Vp-p, impedance = 75Ω Cr/Pr: 0.7Vp-p, impedance = 75Ω	
	Audio	Impedance = 47kΩ or more	
Noise		40 dB	39 / 36dB (lamp mode Normal / Quiet)
Operating temperature		5°C - 35°C	
Power supply		AC100V - 240V 50 / 60Hz	
Power consumption		450W / 1.7W / 0.35W (Projection / standby / standby with LAN OFF)	410W / 365W / 1.7W / 0.35W (normal mode / silent mode / standby / standby with LAN OFF)
Dimensions		380 mm (W) x 150 mm (H) x 430 mm (D) / 15.0 (W) x 5.9 (H) x 16.9 (D) in (not including the projection)	
Weight		8.5 kg / 18.7 lbs (not including projection lens unit)	
Accessories		Remote control, remote control dry-cell batteries, power cord, PC connection cable, User's Manual / Installation Manual (this manual), warranty certificate	

*1 When using a Standard Zoom Lens (RS-IL01ST). Varies depending on the type of lens unit.

*2 When lamp mode (WUX4000) is set to [Normal].

* 99.99% or more of the LCD panel pixels are effective. During projection, 0.01% or less of pixels may stay lit or unlit due to the characteristics of the LCD panel.

* Using the projector continuously for an extended period of time may accelerate the deterioration of optical parts.

Product Specifications

WX6000 / SX6000

Model name		WX6000	SX6000
Display system		RGB liquid crystal system	
Optical system		Color separation by dichroic mirror / polarizing beam splitter and color composition by prism	
Display device	Type	Reflective liquid crystal panel	
	Size / Aspect ratio	0.7" X3 / 16:10	0.72" X3 / 4:3
	Drive system	Active matrix system	
	Number dots / Total number dots	1,296,000 (1440 x 900) x 3 panels / 3,888,000	1,470,000 (1400 x 1050) x 3 panels / 4,410,000
Projection lens(*1)	Zoom ratio / Focal length / F value	1.5 x / f = 23.0 - 34.5 mm / F1.89 - F2.65	
	Zooming / Focusing system	Electric / Electric	
	Lens shift	V: -15% - +55%, H: ±10%	V: -12% - +50%, H: ±10%
Light source		330-NSHA 336 W	
Image size (projection distance) (*1)		40" to 600" (1.3 to 29.7 m)	40" to 600" (1.3 to 28.8 m)
Number of colors		16,770,000 colors (full color)	
Brightness (*1)		5,700 lumen	6,000 lumen
Contrast ratio		1000:1 (Full white: Full black, during presentation)	
Ratio of brightness at periphery to center (*1)		88%	
Speaker		5W monaural x 1	
Maximum input resolution		1440 x 900 dots	1400 x 1050 dots
Video signals	Analog PC input	UXGA / WSXGA+ / SXGA+ / WXGA+ / WXGA / SXGA / XGA / SVGA / VGA	
	Digital PC input	UXGA / WSXGA+ / SXGA+ / WXGA+ / WXGA / SXGA / XGA / SVGA / VGA	
	Digital video input	1080p, 1080i, 720p, 576p, 480p	
	Component video input	1080p, 1080i, 720p, 576p, 576i, 480p, 480i	
Input terminal	DVI-I IN terminal	Analog PC, Digital PC (24-pin DVI connector)	
	HDMI IN terminal	Digital PC, HDMI (deep color)	
	ANALOG PC / COMPONENT IN terminal	Analog PC, Component (mini D-sub 15-pin)	
	CONTROL terminal	RS-232C (D-sub 9-pin)	
	Remote terminal	Wired remote control (3.5Ø stereo mini jack)	
	AUDIO IN Terminal	Audio signal (3.5Ø stereo mini jack x 2)	
AUDIO OUT Terminal		Audio signal (3.5Ø stereo mini jack)	
LAN terminal		Network connection (RJ-45)	
Input signal	Digital PC	TMDS (Transition Minimized Differential Signaling)	
	Analog PC	0.7Vp-p, positive polarity, impedance = 75Ω Horizontal / vertical synchronization: TTL level, negative or positive polarity Composite synchronization in G signal: 0.3Vp-p, negative polarity, impedance = 75Ω	
	Component video	COMPONENT: Separate Y Cb/Pb Cr/Pr signal Y: 1Vp-p, negative synchronization, impedance = 75Ω Cb/Pb: 0.7Vp-p, impedance = 75Ω Cr/Pr: 0.7Vp-p, impedance = 75Ω	
	Audio	Impedance = 47kΩ or more	
Noise		40 dB	
Operating temperature		5°C - 35°C	
Power supply		AC100V - 240V 50 / 60Hz	
Power consumption (Projection / standby / standby with LAN OFF)		435W / 1.7W / 0.35W	
Dimensions		380 mm (W) x 150 mm (H) x 430 mm (D) / 15.0 (W) x 5.9 (H) x 16.9 (D) in (not including the projection)	
Weight		8.5 kg / 18.7 lbs (not including projection lens unit)	
Accessories		Remote control, remote control dry-cell batteries, power cord, PC connection cable, User's Manual / Installation Manual (this manual), warranty certificate	

*1 When using a Standard Zoom Lens (RS-IL01ST). Varies depending on the type of lens unit.

* 99.99% or more of the LCD panel pixels are effective. During projection, 0.01% or less of pixels may stay lit or unlit due to the characteristics of the LCD panel.

* Using the projector continuously for an extended period of time may accelerate the deterioration of optical parts.

■ Remote control

Type	RS-RC04	RS-RC05
Power supply	DC 3.0V, using two AAA-size batteries	DC 3.0V, using two AA-size batteries
Operating range	Approx. 8 m ± 25° horizontal and vertical (to infrared remote receiver)	
Dimensions	43 mm (W) x 23 mm (H) x 135 mm (D) / 1.7 (W) x 0.9 (H) x 5.3 (D) in.	51 mm (W) x 28 mm (H) x 176 mm (D) / 2.0 (W) x 1.1 (H) x 6.9 (D) in.
Weight	56 g / 2.0 oz	100 g / 3.5 oz

■ Specification of Each Lens Unit (Option)

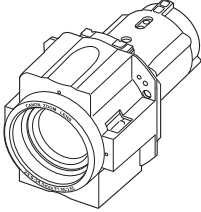
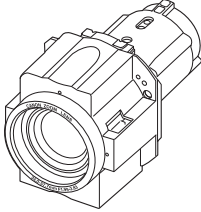
Name	Standard Zoom Lens	Long Zoom Lens
Model number	RS-IL01ST	RS-IL02LZ
External View		
Focal length	23.0 - 34.5 mm (0.9 - 1.4")	34.0 - 57.7 mm (1.3 - 2.3")
F number	1.89 - 2.65	1.99 - 2.83
Projection distance*	1.3 - 28.8 m (4.3 - 94.5')	1.9 - 48.3 m (6.2 - 158.5')
Width	97.4 mm (3.8")	97.4 mm (3.8")
Height	106.5 mm (4.2")	106.5 mm (4.2")
Length	173.4 mm (6.8")	173.4 mm (6.8")
Weight	550 g (1.2 lbs)	755 g (1.7 lbs)
Zoom ratio	1.5x	1.7x
Size 100 projection distance*	3.2 - 4.8 m (10.5 - 15.7')	4.7 - 8.0 m (15.4 - 26.2')

For details about the amount of lens shift, refer to [page 160](#).

*: WUX5000 / WUX4000

Product Specifications

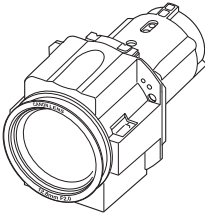
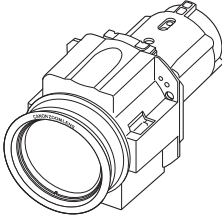
Name	Short Fixed Lens	Ultra Long Zoom Lens
Model number	RS-IL03WF	RS-IL04UL
External View		
Focal length	12.8 mm (0.5")	53.6 - 105.6 mm (2.1 - 4.2")
F number	2.0	2.34 - 2.81
Projection distance*	0.7 - 5.2 m (2.3 - 17.1')	4.6 - 89.0 m (15.1 - 292.0')
Width	97.4 mm (3.8")	97.4 mm (3.8")
Height	106.5 mm (4.2")	106.5 mm (4.2")
Length	175.2 mm (6.9")	184.2 mm (7.3")
Weight	910 g (2.0 lbs)	940 g (2.1 lbs)
Zoom ratio	-	1.95x
Size 100 projection distance*	1.7 m (5.6')	7.6 - 14.9 m (24.9 - 48.9')

For details about the amount of lens shift, refer to [page 160](#).

*: WUX5000 / WUX4000

External View

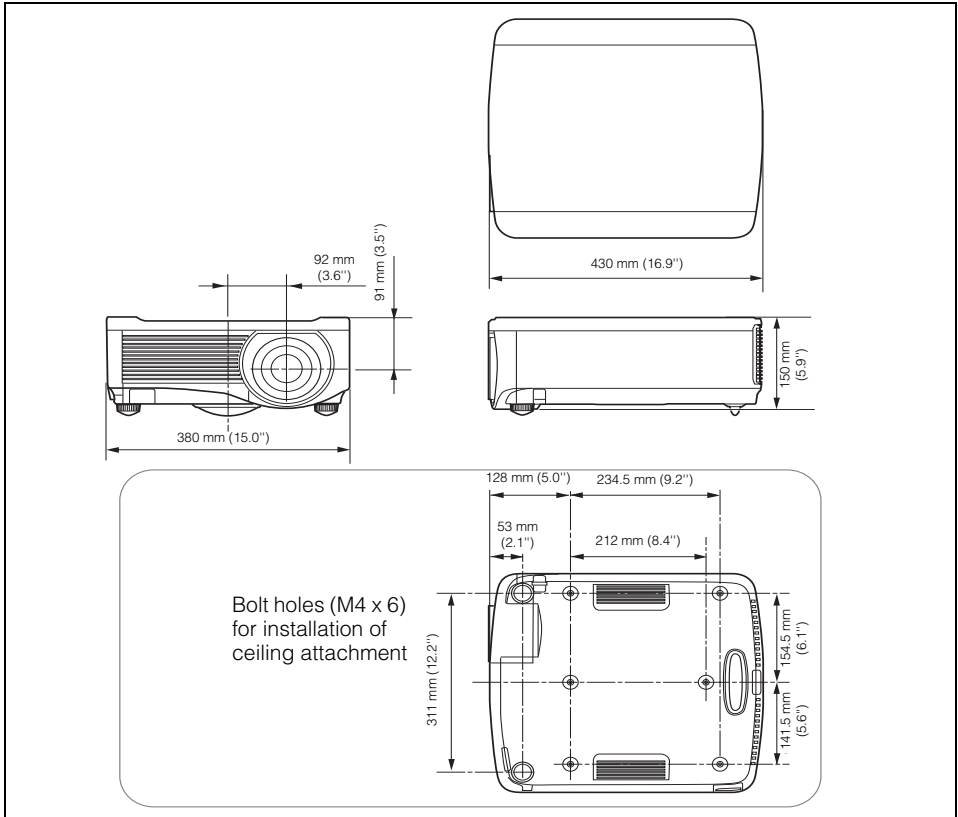

ANALOG PC (WUX5000 / WUX4000), ANALOG PC-1 (WX6000 / SX6000) / COMPONENT IN Terminal

This terminal is used as a computer ANALOG PC input or COMPONENT input terminal. Use a D-sub computer cable for connection.

The terminal specifications for the ANALOG PC input and COMPONENT input are the same.

Mini D-sub 15-pin

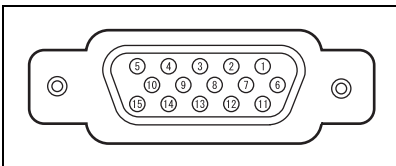

Pin No.	Signal	Pin No.	Signal
1	R	9	+5 V power
2	G	10	Ground (Vertical sync.)
3	B	11	Monitor ID0
4	Monitor ID2	12	DDC data
5	Ground (Horizontal sync.)	13	Horizontal sync.
6	Ground (R)	14	Vertical sync.
7	Ground (G)	15	DDC clock
8	Ground (B)		

Product Specifications

■ Service Port (CONTROL)

Pin assignment

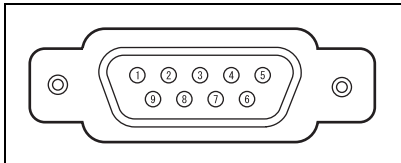

Pin No.	Signal
1	OPEN
2	RxD
3	TxD
4	OPEN
5	GND
6	OPEN
7	OPEN
8	OPEN
9	OPEN

Communication format

Communication mode : RS-232-C, asynchronous, half-duplex communication

Communication speed : 19200bps

Character length : 8 bits

Stop bits : 2 bits

Parity : None

Flow control : None

Control commands

Commands		ASCII representation	Binary representation
Power supply	Power on	POWER ON<CR>	50h 4Fh 57h 45h 52h 20h 4Fh 4Eh 0Dh
	Power off	POWER OFF<CR>	50h 4Fh 57h 45h 52h 20h 4Fh 46h 46h 0Dh
Power status acquisition		GET POWER<CR>	47h 45h 54h 20h 50h 4Fh 57h 45h 52h 0Dh
Input status (WUX5000 / WUX4000)	DVI-D	INPUT=D-RGB<CR>	49h 4Eh 50h 55h 54h 3Dh 44h 2Dh 52h 47h 42h 0Dh
	HDMI	INPUT=HDMI<CR>	49h 4Eh 50h 55h 54h 3Dh 48h 44h 4Dh 49h 0Dh
	Analog PC	INPUT=A-RGB<CR>	49h 4Eh 50h 55h 54h 3Dh 41h 2Dh 52h 47h 42h 0Dh
	Component	INPUT=COMP<CR>	49h 4Eh 50h 55h 54h 3Dh 43h 4Fh 4Dh 50h 0Dh
Input status (WX6000 / SX6000)	HDMI	INPUT=HDMI<CR>	49h 4Eh 50h 55h 54h 3Dh 48h 44h 4Dh 49h 0Dh
	Digital PC	INPUT=D-RGB<CR>	49h 4Eh 50h 55h 54h 3Dh 44h 2Dh 52h 47h 42h 0Dh
	Analog PC1	INPUT=A-RGB1<CR>	49h 4Eh 50h 55h 54h 3Dh 41h 2Dh 52h 47h 42h 31h 0Dh
	Analog PC2	INPUT=A-RGB2<CR>	49h 4Eh 50h 55h 54h 3Dh 41h 2Dh 52h 47h 42h 32h 0Dh
	Component	INPUT=COMP<CR>	49h 4Eh 50h 55h 54h 3Dh 43h 4Fh 4Dh 50h 0Dh
Input source acquisition		GET INPUT<CR>	47h 45h 54h 20h 49h 4Eh 50h 55h 54h 0Dh

Commands		ASCII representation	Binary representation
Image mode	Standard	IMAGE=STANDARD<CR>	49h 4Dh 41h 47h 45h 3Dh 53h 54h 41h 4Eh 44h 41h 52h 44h 0Dh
	Presentation	IMAGE=PRESENTATION<CR>	49h 4Dh 41h 47h 45h 3Dh 50h 52h 45h 53h 45h 4Eh 54h 41h 54h 49h 4Fh 4Eh 0Dh
	VividPhoto	IMAGE=VIVID_PHOTO<CR>	49h 4Dh 41h 47h 45h 3Dh 56h 49h 56h 49h 44h 4Fh 50h 48h 4Fh 54h 4Fh 0Dh
	Photo /sRGB	IMAGE=PHOTO_SRGB<CR>	49h 4Dh 41h 47h 45h 3Dh 50h 48h 4Fh 54h 4Fh 5Fh 53h 52h 47h 42h 0Dh
	Dynamic	IMAGE=DYNAMIC<CR>	49h 4Dh 41h 47h 45h 3Dh 44h 59h 4Eh 41h 4Dh 49h 43h 0Dh
	Video	IMAGE=VIDEO<CR>	49h 4Dh 41h 47h 45h 3Dh 56h 49h 44h 45h 4Fh 0Dh
	Cinema	IMAGE=CINEMA<CR>	49h 4Dh 41h 47h 45h 3Dh 43h 49h 4Eh 45h 4Dh 41h 0Dh
Image mode	User 1	IMAGE=USER_1<CR>	49h 4Dh 41h 47h 45h 3Dh 55h 53h 45h 52h 5Fh 31h 0Dh
	User 2	IMAGE=USER_2<CR>	49h 4Dh 41h 47h 45h 3Dh 55h 53h 45h 52h 5Fh 32h 0Dh
	User 3	IMAGE=USER_3<CR>	49h 4Dh 41h 47h 45h 3Dh 55h 53h 45h 52h 5Fh 33h 0Dh
	User 4	IMAGE=USER_4<CR>	49h 4Dh 41h 47h 45h 3Dh 55h 53h 45h 52h 5Fh 34h 0Dh
	User 5	IMAGE=USER_5<CR>	49h 4Dh 41h 47h 45h 3Dh 55h 53h 45h 52h 5Fh 35h 0Dh
Image mode acquisition		GET IMAGE<CR>	47h 45h 54h 20h 49h 4Dh 41h 47h 45h 0Dh
Brightness	Brightness value setting	BRI=<value><CR>	42h 52h 49h 3Dh <numeric code> 0Dh
Brightness acquisition		GET BRI<CR>	47h 45h 54h 20h 42h 52h 49h 0Dh
Sharpness	Sharpness value setting	SHARP=<value><CR>	53h 48h 41h 52h 50h 3Dh <numeric code> 0Dh
Sharpness acquisition		GET SHARP<CR>	47h 45h 54h 20h 53h 48h 41h 52h 50h 0Dh
Contrast	Contrast value setting	CONT=<value><CR>	43h 4Fh 4Eh 54h 3Dh <numeric code> 0Dh
Contrast acquisition		GET CONT<CR>	47h 45h 54h 20h 43h 4Fh 4Eh 54h 0Dh
Aspect (WUX5000 / WUX4000)	Auto	ASPECT=AUTO<CR>	41h 53h 50h 45h 43h 54h 3Dh 41h 55h 54h 4Fh 0Dh
	4:3	ASPECT=4:3<CR>	41h 53h 50h 45h 43h 54h 3Dh 34h 3Ah 33h 0Dh
	16:9	ASPECT=16:9<CR>	41h 53h 50h 45h 43h 54h 3Dh 31h 36h 3Ah 39h 0Dh
	Zoom	ASPECT=ZOOM<CR>	41h 53h 50h 45h 43h 54h 3Dh 5Ah 4Fh 4Fh 4Dh 0Dh
	True size	ASPECT=TRUE<CR>	41h 53h 50h 45h 43h 54h 3Dh 54h 52h 55h 45h 0Dh
	Full	ASPECT=FULL<CR>	41h 53h 50h 45h 43h 54h 3Dh 46h 55h 4Ch 4Ch 0Dh
Aspect (WX6000 / SX6000)	Auto	ASPECT=AUTO<CR>	41h 53h 50h 45h 43h 54h 3Dh 41h 55h 54h 4Fh 0Dh
	4:3	ASPECT=4:3<CR>	41h 53h 50h 45h 43h 54h 3Dh 34h 3Ah 33h 0Dh
	16:9	ASPECT=16:9<CR>	41h 53h 50h 45h 43h 54h 3Dh 31h 36h 3Ah 39h 0Dh
	16:10	ASPECT=16:10<CR>	41h 53h 50h 45h 43h 54h 3Dh 31h 36h 3Ah 31h 30h 0Dh
	Zoom	ASPECT=ZOOM<CR>	41h 53h 50h 45h 43h 54h 3Dh 5Ah 4Fh 4Fh 4Dh 0Dh
	True size	ASPECT=TRUE<CR>	41h 53h 50h 45h 43h 54h 3Dh 54h 52h 55h 45h 0Dh
Aspect value acquisition		GET ASPECT<CR>	47h 45h 54h 20h 41h 53h 50h 45h 43h 54h 0Dh
Lamp mode	Normal	LAMP=NORMAL<CR>	4Ch 41h 4Dh 50h 3Dh 4Eh 4Fh 52h 4Dh 41h 4Ch 0Dh
	Quiet	LAMP=SILENT<CR>	4Ch 41h 4Dh 50h 3Dh 53h 49h 4Ch 45h 4Eh 54h 0Dh
Lamp mode value acquisition		GET LAMP<CR>	47h 45h 54h 20h 4Ch 41h 4Dh 50h 0Dh

Product Specifications

Commands		ASCII representation	Binary representation
Blank	Blank On	BLANK=ON<CR>	42h 4Ch 41h 4Eh 4Bh 3Dh 4Fh 4Eh 0Dh
	Blank Off	BLANK=OFF<CR>	42h 4Ch 41h 4Eh 4Bh 3Dh 4Fh 46h 46h 0Dh
Blank acquisition		GET BLANK<CR>	47h 45h 54h 20h 42h 4Ch 41h 4Eh 4Bh 0Dh

Index

Numerics

6-axis color adjust 117

A

Adjusting Keystone Distortion 76

Adjusting the focus 73

Adjusting the Volume 83

Air filter 193

Ambient light 115

Analog PC 47, 59, 164

ANALOG PC / COMPONENT IN
terminal (WUX5000 /
WUX4000) 40, 47, 49, 53, 59, 164

Analog PC-1 (WX6000 / SX6000) ... 47, 48

Analog PC-1 / COMPONENT IN
terminal (WX6000 /
SX6000) 41, 48, 49, 54, 59, 164

Analog PC-2 (WX6000 / SX6000) 48

Analog PC-2 / DVI-I IN terminal (WX6000 /
SX6000) 41, 48, 50, 59

ASPECT 70

Aspect 63, 69, 93, 207

AUDIO IN
terminal 40, 41, 47, 50, 53, 139

AUDIO OUT terminal 40, 41, 51, 55

Auto (Aspect) 69

AUTO PC 62

B

Beep 122

BLANK 82

Brightness 111

C

Ceiling mounted 104

Channel setting 124

Component 53, 59, 95, 164

Connection to Computer 47

Contrast 112

D

D. ZOOM 84

D.SHIFT / KEYSTONE
(WUX5000 / WUX4000) 67, 68, 76

DHCP 175

Digital Image Shift 67

Digital PC 50, 59, 164

Direct power on 121

Display Resolution (Preparing the Comput-
er) 61

Display settings menu 88

Displaying logo 106

DVI 50, 59, 164

DVI-D IN (WUX5000 / WUX4000) 50
DVI-D IN terminal
(WUX5000 / WUX4000) 40

DVI-I IN (WX6000 / SX6000) 48, 50

DVI-I IN terminal (WX6000 / SX6000) ... 41

Dynamic gamma 116

F

Factory defaults 140

FOCUS 73

FREEZE 82

G

Guide 126

H

HDMI 51, 52, 59, 164

HDMI color space 99

HDMI IN terminal 40, 41, 51, 52

HDMI input level 98

HDMI over scan 100

Horizontal pixels 97

Horizontal position 96

I

IMAGE 79

Image adjustment menu 88, 89

Image flip H/V (Ceiling mounted /
Rear projection) 104

Image mode 109

Image Mode (Image Quality)	78
Information	88, 89, 141
INPUT	60
Input settings (WX6000 / SX6000)	89
Input signal select	59, 94, 95
Input Terminal	40
Connecting to AV Equipment	52
Connection to Computer	47
Install settings (WX6000 / SX6000)	89

K

Key lock	123
Keystone	76
KEYSTONE (WX6000 / SX6000)	76

L

LAMP (WUX4000)	119
Lamp counter	135
Lamp mode (WUX4000)	119
Lamp replacement	135, 195, 196
LAN port	40, 41
Language	125
LED indicator	202

M

Memory Color Correction	117
MENU	88, 89
Menu display time	132
Menu position	102
MUTE	83

N

Network function	172
Network Password setting	173
Network setting	88, 89
Network setting initialization	176
Network setting lock	171
Noise reduction	116

O

OK	35, 36
----------	--------

P

Password settings	128
Performing Gamma Correction	113
PJLink	174
Positional lock (WX6000 / SX6000)	139
POWER	56, 80, 121
Power Management	57
Power management mode (settings) ..	120
Power Saving (Power Management)	57
Progressive	101
Projector on	106
P-TIMER (WUX5000 / WUX4000)	85

R

Rear projection	104
Register password	129
Remote control	29, 34, 36, 124
Reset	119, 140

S

Screen aspect	63, 107, 207
Screen color	103
Screen When Blank	106
Selecting a language	57, 125
Selecting an Image Quality	109
Setting Display Status	93
Setting Various Functions	120
Sharpness	113
Side Control	38
Signal type	218
System settings menu	88, 89

T

TCP/IP settings	175
Test pattern (WX6000 / SX6000)	138, 217
Total dots	95
Tracking	96
True size (Aspect)	69
Turning on external monitor output (preparing the notebook computer)	58

Index

V

Vertical pixels	98
Vertical Position	97
VOL	83

W

WARNING indicator	38, 202
-------------------------	---------

Z

ZOOM	71
Zoom (Aspect)	69
Zooming an Image	84

Option

- | | |
|--|---|
| <ul style="list-style-type: none">• Lamp
Part No.: RS-LP06 (WUX4000)
RS-LP07 (WUX5000 / WX6000 / SX6000)• Ceiling attachment
Part No.: RS-CL11• Ceiling-mount pipe (400 - 600 mm)
Part No.: RS-CL08*• Ceiling-mount pipe (600 - 1000 mm)
Part No.: RS-CL09*• Black top panel
Part No.: RS-TC01 | <ul style="list-style-type: none">• Air filter
Part No.: RS-FL01• Standard Zoom Lens
Part No.: RS-IL01ST• Long Zoom Lens
Part No.: RS-IL02LZ• Short Fixed Lens
Part No.: RS-IL03WF• Ultra Long Zoom Lens
Part No.: RS-IL04UL• Remote control
Part No.: RS-RC04 (WUX5000 / WUX4000)
RS-RC05 (WX6000 / SX6000) |
|--|---|

* Use the above materials to hang the projector from the ceiling. For details, refer to the assembly and installation manual provided with the ceiling attachment RS-CL11.

• Installing / Removing the Lens Unit

It is possible to use replace the lens unit. Regarding installation and replacement of the lens unit, contact a qualified technician or the Canon Customer Support Center for further information. Do not attempt installation and replacement of the lens unit yourself.

• Precaution for qualified technicians

Before installation and replacement the lens unit, check the part number and use the correct lens unit.

Menu Configuration **WUX5000 / WUX4000**

Display settings Menu

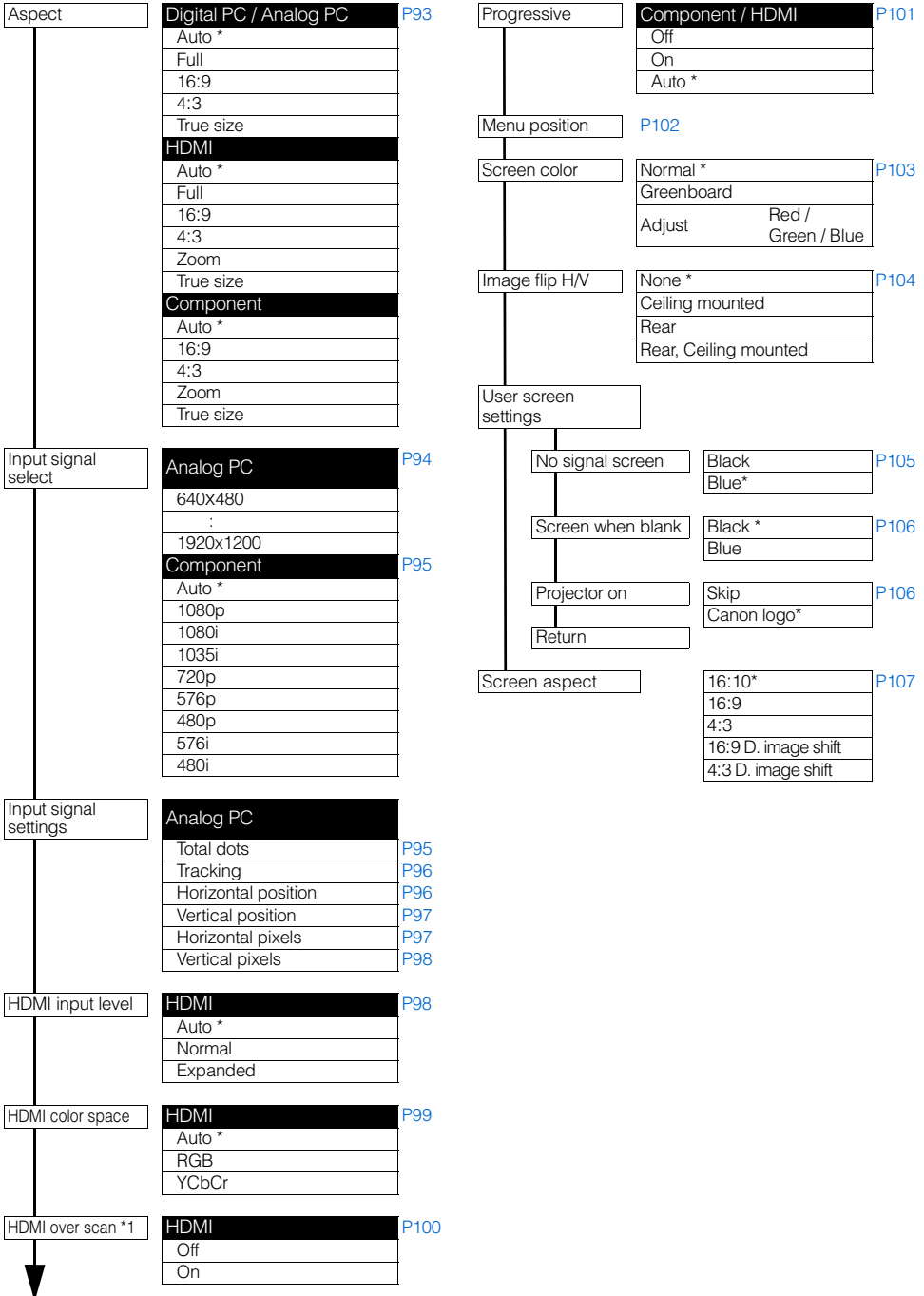
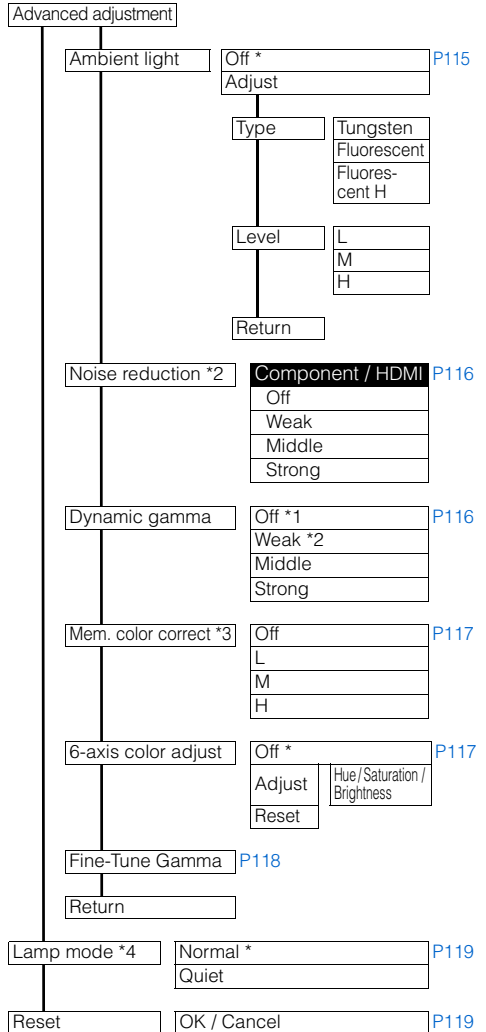
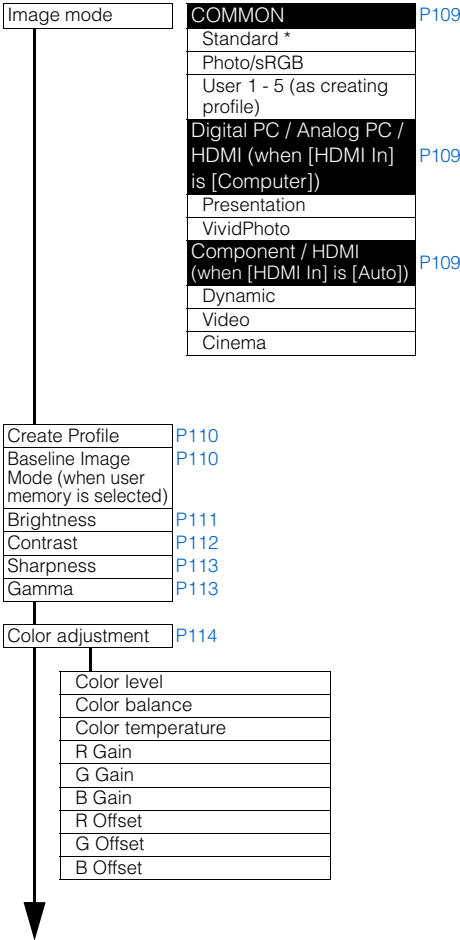

Image Adjustment Menu



Factory default settings for *1, *2 and *3 are set according to the following conditions.

- *1: • For Analog PC, Digital PC or HDMI (when [HDMI In] is [Computer]), the factory default is [Off].
- For Component, and HDMI (when [HDMI In] is [Auto]), the factory default is [On].
- *2: • For HDMI (when [HDMI In] is [Auto]), the factory default is [Off].
- For Component, the factory default is [Weak].
- *3: • For HDMI (when [HDMI In] is [Computer]), Digital PC or Analog PC, if any image mode is used except [VividPhoto], the factory default is [Off].
- If [VividPhoto] is used, the factory default is [Middle].
- For HDMI (when [HDMI In] is [Auto]) or Component, the factory default is [Weak], regardless of the image mode.
- *4: • WUX4000

System Settings Menu

Power management mode	Off *	P120
	Standby	
	Exit	
Direct power on	Off *	P121
	On	
Beep	Off	P122
	On *	
Key lock	Off *	P123
	Main unit	
	Remote control	
Remote control	Ch1	P124
	Ch2	
	Ch3	
	Ch4	
	Independent *	
Language	English	P125
	German	
	French	
	Italian	
	Spanish	
	Portuguese	
	Swedish	
	Russian	
	Dutch	
	Finnish	
	Norwegian	
	Turkish	
	Polish	
	Hungarian	
	Czech	
	Danish	
	Arabic	
	Chinese (Simplified)	
	Chinese (Traditional)	
	Korean	
	Japanese	
Guide	Off	P126
	On *	
Show Input Status	Off	P127
	On *	
HDMI In	Auto *	P127
	Computer	
Other settings		
Password settings	Off *	P128
	On	
Register password	Password input	P129
Lens Ctrl Lock	Off *	P130
	On	
Lens shift Reset	Lens shift Reset	P131
Menu display time	Normal *	P132
	Extended	
Overheat Warning Display	Off *	P133
	On	
Deflicker	Off *	P134
	Adjust	
Lamp counter	Return	P135
	Reset (OK / Cancel)	
Factory defaults	OK / Cancel	P140
Return		

Network Setting Menu

Network setting lock	Unlock	P171
	Lock *	
Network function	Off *	P172
	On	
Network Password setting	Off	P173
	On *	
Register Network Password	Password input	P173
PJLink	Off	P174
	On *	
DHCP	Off *	P175
	On	
TCP/IP setting	IP address	P175
	Subnet mask	
	Gateway address	
	Enter	
Network setting initialization	Yes / No	P176

Information Menu

Model name	P141
Input signal	
Firmware	
Serial No.	
IP address	
Gateway address	
E-mail sender address	
E-mail recipient address	
Projector name	
Location	
System information ID	

*: Factory defaults (setting after reset)

Input Settings Menu

Aspect	<p>Digital PC / Analog PC-1 / 2 / HDMI (when [HDMI In] is [PC]) P93</p> <p>Auto *</p> <p>16:10</p> <p>16:9</p> <p>4:3</p> <p>True size</p> <p>HDMI (when [HDMI In] is [Auto]) / Component</p> <p>Auto *</p> <p>16:10</p> <p>16:9</p> <p>4:3</p> <p>Zoom</p> <p>True size</p>
Auto PC	P94
Input signal select	<p>Analog PC-1 / 2 P94</p> <p>640 x 480</p> <p>:</p> <p>1920 x1200</p>
Input signal settings	<p>Analog PC-1 / 2</p> <p>Total dots P95</p> <p>Tracking P96</p> <p>Horizontal position P96</p> <p>Vertical position P97</p> <p>Horizontal pixels P97</p> <p>Vertical pixels P98</p>
HDMI input level	<p>HDMI P98</p> <p>Auto *</p> <p>Normal</p> <p>Expanded</p>
HDMI color space	<p>HDMI P99</p> <p>Auto *</p> <p>RGB</p> <p>YCbCr</p>
HDMI over scan*1	<p>HDMI P100</p> <p>Off</p> <p>On</p>
Progressive	<p>Component / HDMI P101</p> <p>Off</p> <p>On</p> <p>Auto *</p>

Image Adjustment Menu

Image mode	COMMON	P109
	Standard *	
	Photo/sRGB	
	User 1 - 5 (when creating profile)	
	Digital PC / Analog PC-1/2 / HDMI (when [HDMI In] is [Computer])	P109
	Presentation	
	VividPhoto	
	Component / HDMI (when [HDMI In] is [Auto])	P109
	Dynamic	
	Video	
	Cinema	

Create Profile	P110
Save profile (When profile is selected)	P110
Baseline Image Mode (When profile is selected)	P111
Brightness	P111
Contrast	P112
Sharpness	P113
Gamma	P113

Color adjustment	P114
Color level	
Color balance	
Color temperature	
R Gain	
G Gain	
B Gain	
R Offset	
G Offset	
B Offset	

Advanced adjustment		
Ambient light	Off *	P115
	Adjust	
	Type	Tungsten Fluorescent Fluorescent H
	Level	L M H
	Return	
Noise reduction *2	Component / HDMI	P116
	Off	
	Weak	
	Middle	
	Strong	
Dynamic gamma	Off *1	P116
	Weak *2	
	Middle	
	Strong	
Mem. color correct *3	Off	P117
	L	
	M	
	H	
6-axis color adjust	Off *	P117
	Adjust	Hue / Saturation / Brightness
	Reset	
Fine-Tune Gamma	P118	
	Return	
Reset	OK / Cancel	P119

Install settings Menu

Positional lock	Off *	P139
	On	

Test pattern	Off *	P138
	On	

Screen aspect	16:10 *5	P107
	16:9	
	4:3 *4	
	16:10 D. image shift (SX6000)	
	16:9 D. image shift (WX6000)	

Keystone adjustment	Keystone adjustment	P108
---------------------	---------------------	------

Digital image shift	D. image shift adjustment	P108
---------------------	---------------------------	------

Image flip H/V	None*	P104
	Ceiling mounted	
	Rear	
	Rear, Ceiling mounted	

Lens shift reset	Lens shift reset	P131
------------------	------------------	------

Audio in terminal select	HDMI	Off	P139
		Audio in 1	
		Audio in 2	
		HDMI *	
Digital PC	Digital PC	Off	P139
		Audio in 1	
		Audio in 2 *	
Analog PC-1	Analog PC-1	Off	P139
		Audio in 1 *	
		Audio in 2	
Analog PC-2	Analog PC-2	Off	P139
		Audio in 1	
		Audio in 2 *	
Component	Component	Off	P139
		Audio in 1 *	
		Audio in 2	

Screen color	Normal *	P103
	Greenboard	
	Adjust	

On screen	Menu position	P102	
	Guide	Off	P126
		On *	
	Show input status	Off	P127
	Overheat warning display	Off *	P133
		On	
Menu display time	Normal *	P132	
	Extended		

Lamp warning display	Off	P135
	On *	

Filter warning display	Off	P137
	On *	

- *1 - *5: Factory default settings are set according to the following conditions.
- *1: • For Analog PC-1/2, Digital PC or HDMI (when [HDMI In] is [Computer]), the factory default is [Off].
 - For Component, and HDMI (when [HDMI In] is [Auto]), the factory default is [On].
 - *2: • For HDMI (when [HDMI In] is [Auto]), the factory default is [Off].
 - For Component, the factory default is [Weak].
 - *3: • For HDMI (when [HDMI In] is [Computer]), Digital PC or Analog PC-1/2, if any image mode is used except [VividPhoto], the factory default is [Off]. If [VividPhoto] is used, the factory default is [Middle].
 - For HDMI (when [HDMI In] is [Auto]) or Component, the factory default is [Weak], regardless of the image mode.
 - *4: • SX6000
 - *5: • WX6000

System Settings Menu

Power management mode	Off * Standby Exit	P120	
Direct power on	Off * On	P121	
User screen settings			
No signal screen	Black Blue *	P105	
Screen when blank	Black * Blue	P106	
Projector on	Skip Canon logo *	P106	
Beep	Off On *	P122	
Key Repeat	Off On *	P122	
Key lock	Off * Main unit Remote (wireless)	P123	
Remote control	Ch1 Ch2 Ch3 Ch4 Independent*	P124	
HDMI In	Auto * Computer	P127	
Language	English German French Italian Spanish Portuguese Swedish Russian Dutch Finnish Norwegian	Turkish Polish Hungarian Czech Danish Arabic Chinese (Simplified) Chinese (Traditional) Korean Japanese	P125
Other settings			
Password settings	Off * On	P128	
Register password	Password input	P129	
Gamma restore	Off Adjust	P134	
Lamp counter	Return Reset (OK / Cancel)	P135	
Filter counter	Return Reset (OK / Cancel)	P137	
Factory defaults	OK / Cancel	P140	
Return			

Network Setting Menu

Network setting lock	Unlock Lock *	P171
Network function	Off * On	P172
Network Password setting	Off On *	P173
Register Network Password	Password input	P173
PJLink	Off On *	P174
DHCP	Off * On	P175
TCP/IP setting	IP address Subnet mask Gateway address Enter	P175
Network setting initialization	Yes / No	P176

Information Menu

Model name	P141
Input signal	
Firmware	
Serial No.	
IP address	
Gateway address	
E-mail sender address	
E-mail recipient address	
Projector name	
Location	
System information ID	

*: Factory defaults (setting after reset)

**CANON INC.**

30-2, Shimomaruko 3-chome, Ohta-ku, Tokyo
146-8501, Japan

U.S.A.

CANON U.S.A. INC.

One Canon Plaza, Lake Success, NY 11042-
1198, U.S.A.

For all inquiries concerning this product, call toll
free in the U.S. 1-800-OK-CANON

CANADA

CANON CANADA INC. HEADQUARTERS

6390 Dixie Road, Mississauga, Ontario L5T
1P7, Canada

CANON CANADA INC. MONTREAL BRANCH

5990, Côte-de-Liesse, Montréal Québec H4T
1V7, Canada

CANON CANADA INC. CALGARY OFFICE

2828, 16th Street, N.E. Calgary, Alberta T2E
7K7, Canada

For all inquiries concerning this product, call toll
free in Canada

1-800-OK-CANON

EUROPE, AFRICA & MIDDLE EAST

CANON EUROPE LTD.

3 The Square Stockley Park, Uxbridge, Middle-
sex, UB11 1ET United Kingdom

CANON EUROPA N.V.

Bovenkerkerweg 59-61, 1185 XB Amstelveen,
The Netherlands

CANON FRANCE S.A.S

17, quai du President Paul Doumer, 92414
Courbevoie Cedex, France

CANON UK LTD.

Woodhatch Reigate Surrey RH2 8BF, United
Kingdom

CANON DEUTSCHLAND GmbH

Europark Fichtenhain A10, 47807 Krefeld, Ger-
many

CANON ITALIA S.p.A.

Via Milano 8 I-20097 San Donato Milanese, Mil-
ano, Italy

CANON Schweiz AG

Geschäftsbereich Wiederverkauf, Industri-
estrasse 12, CH-8305 Dietlikon,
Switzerland

CANON GMBH

Zetschegasse 11, A-1230 Wien, Austria

CANON España, S.A.

Av. De Europa, 6 Alcobendas 28108 Madrid,
Spain

CANON PORTUGAL S.A.

Rua Alfredo da Silva, 14 Alfragide 2610-016
Amadora, Portugal

CANON Belgium N.V. / S.A.

Berkenlaan 3, 1831 Diegem (Mechelen), Bel-
gium

CANON Netherland NV

Neptunusstraat 1, 2132 JA Hoofddorp, The
Netherlands

CANON LUXEMBOURG S.A.

Rue des Joncs 21, L-1818 Howald, Luxem-
bourg

CANON DANMARK A / S

Knud Hoejgaards Vej 1 DK-2860 Soeborg, Dan-
mark

CANON OY

Huopalahdentie 24 PL 1 00351 Helsinki, Fin-
land

CANON SVENSKA AB

Gustav III:s Boulevard 26 169 88 Solna, Swe-
den

CANON NORGE as

Hallagerbakken 110, Postboks 33, Holmlia,
1201 Oslo, Norway

CENTRAL & SOUTH AMERICA

CANON LATIN AMERICA, INC.

703 Waterford Way, Ste. 400 Miami, FL 33126,
U.S.A.

ASIA

CANON (China) Co., Ltd.

15F Jinbao Building No.89 Jinbao Street,
Dongcheng District, Beijing 100005, China

CANON HONGKONG CO., LTD.

19 / F., The Metropolis Tower, 10 Metropolis
Drive, Hungghom, Kowloon, Hong Kong

CANON SINGAPORE PTE. LTD.

1 HarbourFront Avenue, #04-01 Keppel Bay
Tower, Singapore 098632

CANON KOREA CONSUMER IMAGING INC.

Canon BS Tower 5F, #168-12 Samseong-dong,
Gangnam-gu, Seoul, Korea

OCEANIA

CANON AUSTRALIA PTY. LTD.

1 Thomas Holt Drive, North Ryde, N.S.W. 2113,
Australia

CANON NEW ZEALAND LTD.

Akoranga Business Park, Akoranga Drive,
Northcote, Auckland, New Zealand