



**HT8050**  
**Digital Projector**  
**User Manual**

# Warranty and Copyright information

## Limited warranty

BenQ warrants this product against any defects in material and workmanship, under normal usage and storage.

Proof of purchase date will be required with any warranty claim. In the event this product is found to be defective within the warranty period, BenQ's only obligation and your exclusive remedy shall be replacement of any defective parts (labor included). To obtain warranty service, immediately notify the dealer from which you purchased the product of any defects.

Important: The above warranty shall be void if the customer fails to operate the product in accordance with BenQ's written instructions, especially the ambient humidity must be in-between 10% and 90%, temperature in-between 0°C and 35°C, altitude lower than 4920 feet, and avoiding to operate the projector in a dusty environment. This warranty gives you specific legal rights, and you may have other rights which vary from country to country.

For other information, please visit [www.BenQ.com](http://www.BenQ.com).

## Copyright

Copyright 2016 by BenQ Corporation. All rights reserved. No part of this publication may be reproduced, transmitted, transcribed, stored in a retrieval system or translated into any language or computer language, in any form or by any means, electronic, mechanical, magnetic, optical, chemical, manual or otherwise, without the prior written permission of BenQ Corporation.

## Disclaimer

BenQ Corporation makes no representations or warranties, either expressed or implied, with respect to the contents hereof and specifically disclaims any warranties, merchantability or fitness for any particular purpose. Further, BenQ Corporation reserves the right to revise this publication and to make changes from time to time in the contents hereof without obligation to notify any person of such revision or changes.

\*DLP, Digital Micromirror Device and DMD are trademarks of Texas Instruments. Others are copyrights of their respective companies or organizations.

## Patents

Please go to <http://patmarking.benq.com/> for the details on BenQ projector patent coverage.

# Table of Contents

<b>Warranty and Copyright information</b> .....	<b>2</b>
<b>Important safety instructions</b> .....	<b>4</b>
<b>Introduction</b> .....	<b>7</b>
Shipping contents .....	7
Projector exterior view .....	8
Controls and functions .....	9
<b>Positioning your projector</b> .....	<b>11</b>
Choosing a location .....	11
Obtaining a preferred projected image size.....	12
Mounting the projector.....	13
Adjusting the projector position.....	14
Adjusting the projected image.....	15
<b>Connection</b> .....	<b>16</b>
<b>Operation</b> .....	<b>18</b>
Starting up the projector .....	18
Using the menus .....	20
Securing the projector .....	21
Switching input signal .....	22
Shutting down the projector .....	23
Direct power off .....	23
<b>Menu operation</b> .....	<b>24</b>
<b>PICTURE</b> menu .....	24
<b>DISPLAY</b> menu.....	28
<b>INSTALLATION</b> menu .....	28
<b>SYSTEM SETUP: BASIC</b> menu .....	29
<b>SYSTEM SETUP: ADVANCED</b> menu .....	30
<b>INFORMATION</b> menu .....	31
<b>Maintenance</b> .....	<b>32</b>
Care of the projector .....	32
Lamp information .....	32
<b>Troubleshooting</b> .....	<b>39</b>
<b>Specifications</b> .....	<b>40</b>
Projector specifications .....	40
Dimensions .....	40
Timing chart.....	41

# Important safety instructions

Your projector is designed and tested to meet the latest standards for safety of information technology equipment. However, to ensure safe use of this product, it is important that you follow the instructions mentioned in this manual and marked on the product.

1. **Please read this manual before you operate your projector.** Save it for future reference.

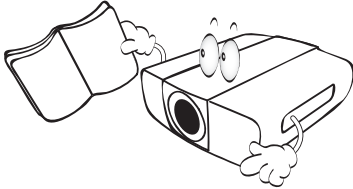

2. **Do not look straight at the projector lens during operation.** The intense light beam may damage your eyes.

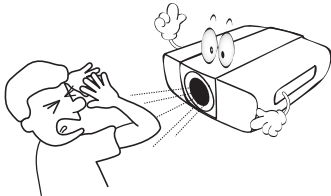

3. **Refer servicing to qualified service personnel.**

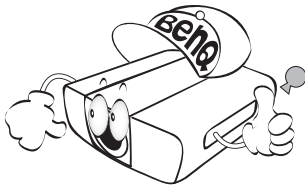

4. **Always open the lens shutter (if any) or remove the lens cap (if any) when the projector lamp is on.**

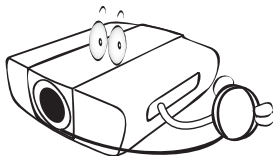

5. The lamp becomes extremely hot during operation. Allow the projector to cool for approximately 45 minutes prior to removing the lamp assembly for replacement.

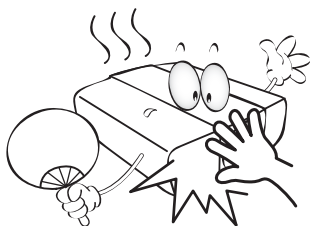

6. In some countries, the line voltage is NOT stable. This projector is designed to operate safely within a mains voltage between 100 to 240 volts AC, but could fail if power cuts or surges of  $\pm 10$  volts occur. **In areas where the mains voltage may fluctuate or cut out, it is recommended that you connect your projector through a power stabilizer, surge protector or uninterruptible power supply (UPS).**

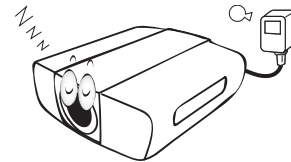

7. Do not block the projection lens with any objects when the projector is under operation as this could cause the objects to become heated and deformed or even cause a fire. To temporarily turn off the lamp, use the blank function.

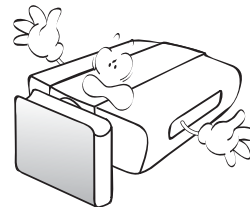

8. Do not operate lamps beyond the rated lamp life. Excessive operation of lamps beyond the rated life could cause them to break on rare occasions.

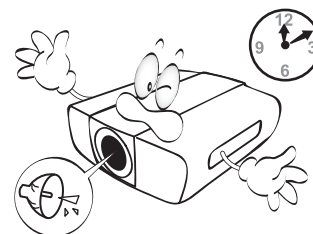

9. Never replace the lamp assembly or any electronic components unless the projector is unplugged.

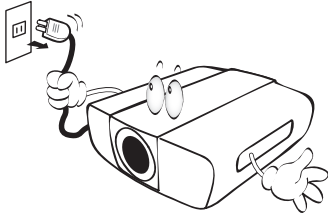

10. Do not place this product on an unstable cart, stand, or table. The product may fall, sustaining serious damage.

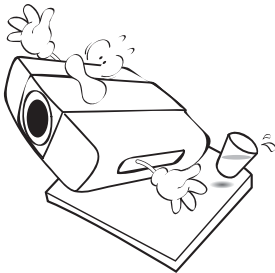

11. Do not attempt to disassemble this projector. There are dangerous high voltages inside which may cause death if you should come into contact with live parts. The only user serviceable part is the lamp which has its own removable cover.

Under no circumstances should you ever undo or remove any other covers. Refer servicing only to suitably qualified professional service personnel.

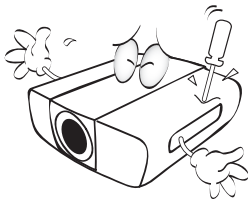

12. Do not block the ventilation holes.

- Do not place this projector on a blanket, bedding or any other soft surface.
- Do not cover this projector with a cloth or any other item.
- Do not place inflammables near the projector.

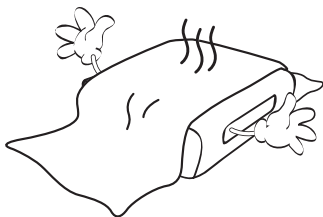

If the ventilation holes are seriously obstructed, overheating inside the projector may result in a fire.

13. Always place the projector on a level, horizontal surface during operation.

- Do not use if tilted at an angle of more than 10 degrees left to right, nor at angle of more than 15 degrees front to back. Using the projector when it is not fully horizontal may cause a malfunction of, or damage to, the lamp.



14. Do not stand the projector on end vertically. Doing so may cause the projector to fall over, causing injury or resulting in damage to the projector.

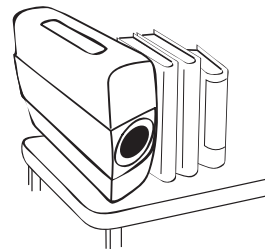

15. Do not step on the projector or place any objects upon it. Besides probable physical damage to the projector, doing so may result in accidents and possible injury.

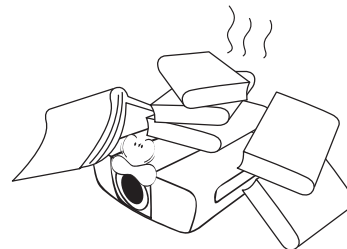

16. When the projector is under operation, you may sense some heated air and odor from its ventilation grill. It is a normal phenomenon and not a product defect.

17. Do not place liquids near or on the projector. Liquids spilled into the projector may cause it to fail. If the projector does become wet, disconnect it from the power supply's power outlet and call BenQ to have the projector serviced.

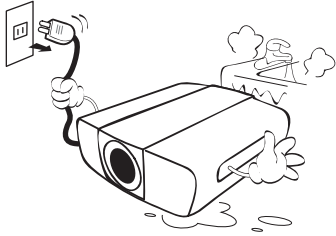

18. This product is capable of displaying inverted images for ceiling mount installation.

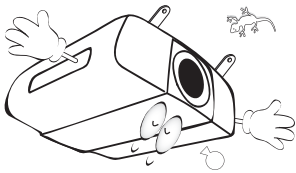

19. This apparatus must be earthed.

 Hg - Lamp contains mercury. Manage in accordance with local disposal laws. See [www.lamprecycle.org](http://www.lamprecycle.org).

20. Do not place this projector in any of the following environments.

- Space that is poorly ventilated or confined. Allow at least 50 cm clearance from walls and free flow of air around the projector.
- Locations where temperatures may become excessively high, such as the inside of a car with all windows rolled up.
- Locations where excessive humidity, dust, or cigarette smoke may contaminate optical components, shorten the projector's life span and darken the image.

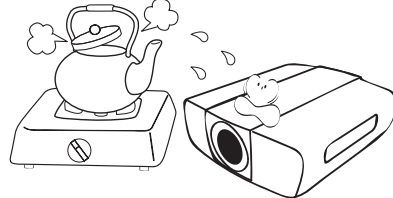

- Locations near fire alarms
- Locations with an ambient temperature above 40°C / 104°F
- Locations where the altitudes are higher than 3000 m (10000 feet).

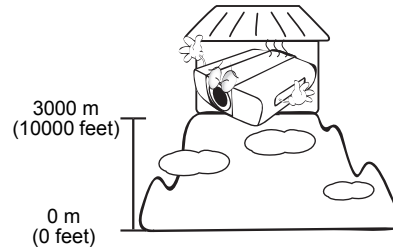

# Introduction

## Shipping contents

Carefully unpack and verify that you have all of the items shown below. If any of these items are missing, please contact your place of purchase.

### Standard accessories

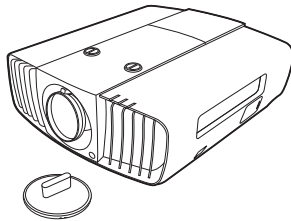

Projector

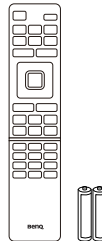

Remote control with batteries

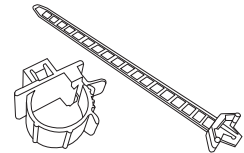

Cable tie set x 3



Quick start guide



User manual CD



Warranty card\*

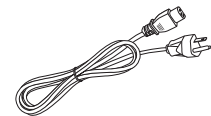

Power cord



• The supplied accessories will be suitable for your region, and may differ from those illustrated.

• \*The warranty card is only supplied in some specific regions. Please consult your dealer for detailed information.

### Optional accessories

1. Spare lamp kit
2. Ceiling mount kit
3. RS232 cable
4. Anamorphic lens

### Replacing the remote control batteries

1. Press and slide off the battery cover, as illustrated.
2. Remove the old batteries (if applicable) and install two AAA batteries. Make sure that the positive and negative ends are positioned correctly, as illustrated.
3. Slide the battery cover in until it clicks into place.

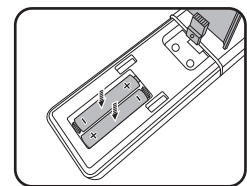
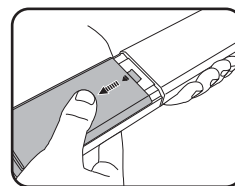

• Avoid leaving the remote control and batteries in an excessive heat or humid environment like the kitchen, bathroom, sauna, sunroom or in a closed car.

• Replace only with the same or equivalent type recommended by the battery manufacturer.

• Dispose of the used batteries according to the manufacturer's instructions and local environment regulations for your region.

• Never throw the batteries into a fire. There may be danger of an explosion.

• If the batteries are dead or if you will not be using the remote control for an extended period of time, remove the batteries to avoid damage to the remote control from possible battery leakage.

# Projector exterior view

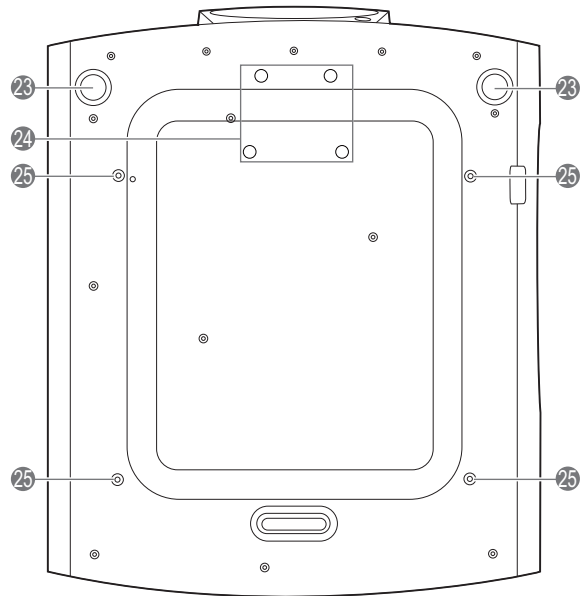
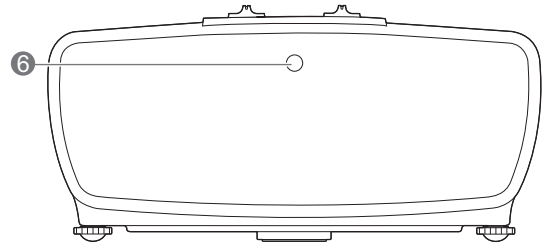
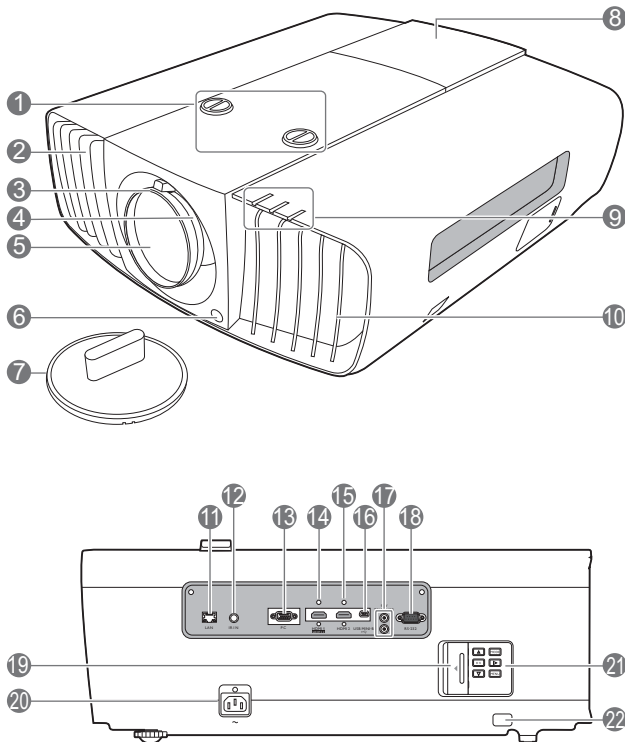

1. Lens shift adjustment knobs (LEFT/RIGHT, UP/DOWN)

2. Vent (heated air exhaust)

3. Focus ring

4. Zoom ring

5. Projection lens

6. IR remote sensor

7. Lens cover

8. Lamp cover

9. **POWER indicator light/TEMPerature warning light/LAMP indicator light** (See [Indicators on page 37.](#))

10. Vent (cool air intake)

11. RJ-45 LAN input jack

12. IR-IN jack

For use with an IR extender cable to ensure better signal reception from the remote control.

13. RGB (PC) signal input jack

14. HDMI input port (Version 2.0) and its cable tie hole

15. HDMI input port (Version 1.4a) and its cable tie hole

16. USB Mini-B port

17. 12 VDC output terminals

Trigger external devices such as an electric screen or light control, etc.

18. RS-232 control port (9600 baud rate)

19. Door to external control panel

20. AC power jack and its cable tie hole

21. External control panel (See [Controls and functions on page 9.](#))

22. Kensington anti-theft lock slot

23. Adjuster feet

24. Anamorphic lens holes

25. Ceiling mount holes



# Controls and functions

## Projector & Remote control



All the key presses described in this document are available on the remote control or projector.

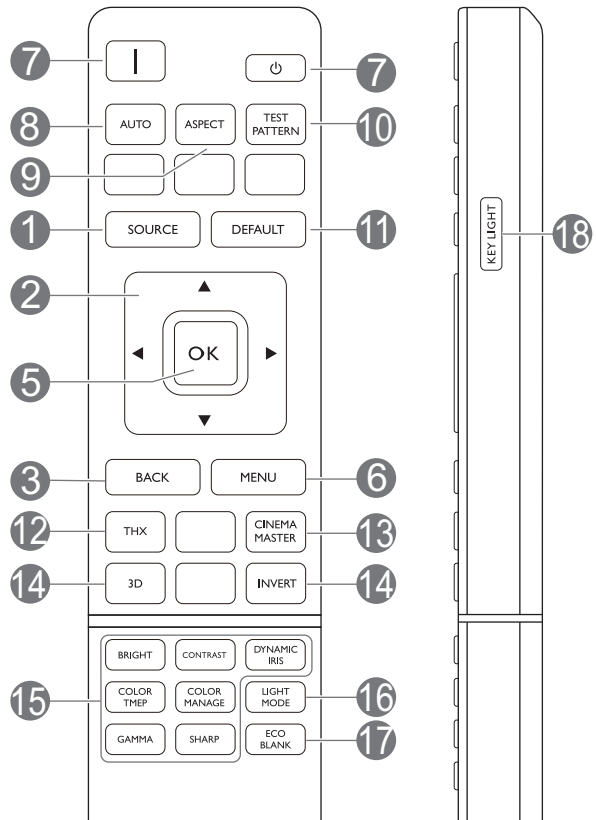
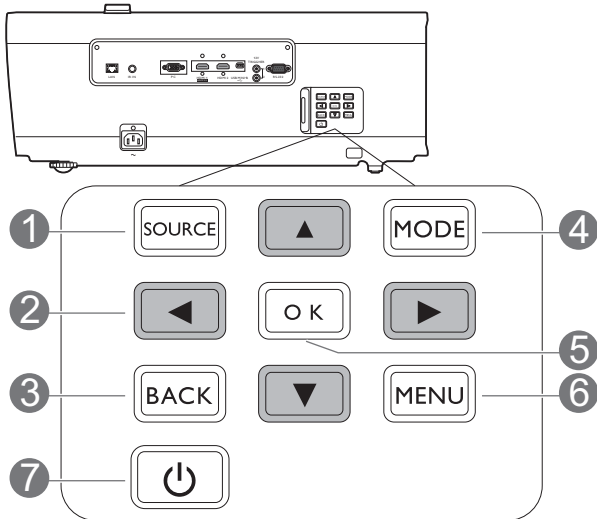

### 1. **SOURCE**

Displays the source selection bar.

### 2. Arrow keys (▲, ▼, ◀, ▶)

When the On-Screen Display (OSD) menu is activated, these keys are used as directional arrows to select the desired menu items and to make adjustments.

### 3. **BACK**

Goes back to previous OSD menu, exits and saves menu settings.

### 4. **MODE**

Selects an available picture setup mode.

### 5. **OK**

Confirms the selected On-Screen Display (OSD) menu item.

### 6. **MENU**

Turns on the On-Screen Display (OSD) menu.

### 7. **POWER**

Toggles the projector between standby mode and on.

### 8. **AUTO**

Automatically determines the best picture timings for the displayed image.

### 9. **ASPECT**

Selects the display aspect ratio.

### 10. **TEST PATTERN**

Displays the test pattern.

### 11. **DEFAULT**

Resets the current function to default factory setting.

### 12. **THX**

Selects the **THX** picture mode, a color mode and image quality certified by THX Ltd.

### 13. **CINEMAMASTER**

Displays the **CinemaMaster** menu.

See [CinemaMaster on page 27](#).

#### 14. 3D/INVERT

The key functions are not available with this model.

#### 15. Picture quality adjustment keys (**BRIGHT, CONTRAST, DYNAMIC IRIS, COLOR TEMP, COLOR MANAGE, GAMMA, SHARP**)

Displays the setting bars for adjustments of the appropriate picture quality values.

#### 16. LIGHT MODE

Selects a suitable lamp power from among the provided modes.

#### 17. ECO BLANK

Used to hide the screen picture.



Do not block the projection lens from projecting as this could cause the blocking object to become heated and deformed or even cause a fire.

#### 18. KEY LIGHT

Turns on the remote control backlight for a few seconds. To keep the backlight on, press any other key while the backlight is on. Press the key again to turn the backlight off.

### Remote control effective range

The remote control must be held at an angle within 30 degrees perpendicular to the projector's IR remote control sensor(s) to function correctly. The distance between the remote control and the sensor(s) should not exceed 8 meters (~ 26 feet).

Make sure that there are no obstacles between the remote control and the IR sensor(s) on the projector that might obstruct the infra-red beam.

- Operating the projector from the front

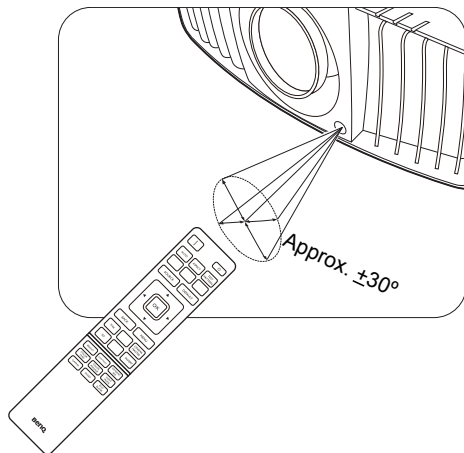

- Operating the projector from the rear

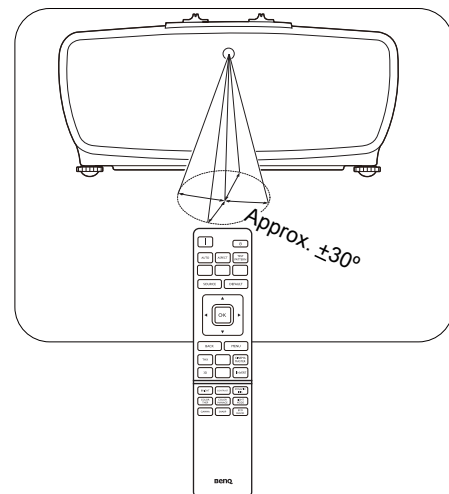

# Positioning your projector

## Choosing a location

Before choosing an installation location for your projector, take the following factors into consideration:

- Size and position of your screen
- Electrical outlet location
- Location and distance between the projector and the rest of your equipment

You can install your projector in the following ways.

### 1. Front Table

Select this location with the projector placed on the table in front of the screen. This is the most common way to position the projector for quick setup and portability.

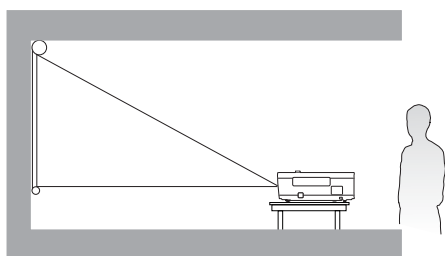

### 2. Front Ceiling

Select this location with the projector suspended upside-down from the ceiling in front of the screen. Purchase the BenQ Projector Ceiling Mount Kit from your dealer to mount your projector on the ceiling.

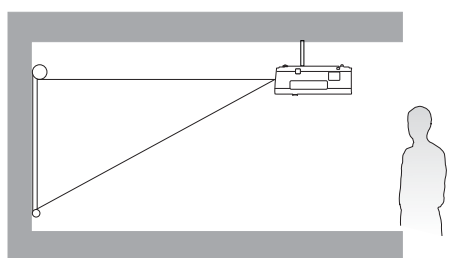

### 3. Rear Ceiling

Select this location with the projector suspended upside-down from the ceiling behind the screen. Note that a special rear projection screen and the BenQ Projector Ceiling Mount Kit are required for this installation location.

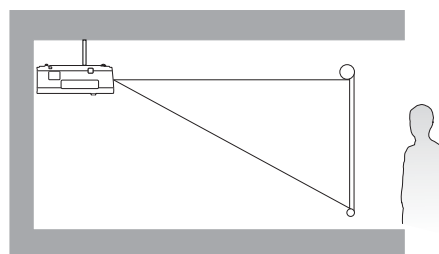

### 4. Rear Table

Select this location with the projector placed on the table behind the screen. Note that a special rear projection screen is required.

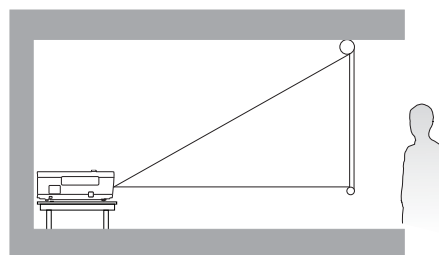

After turning on the projector, go to **INSTALLATION > Projector Position** and press ◀/▶ to select a setting.

# Obtaining a preferred projected image size

The distance from the projector lens to the screen, the zoom setting, and the video format each factors in the projected image size.

## Projection dimensions

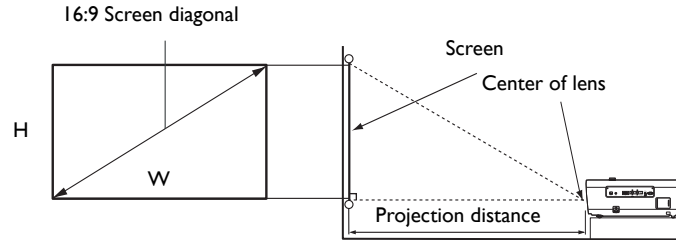

- The screen aspect ratio is 16:9 and the projected picture is in a 16:9 aspect ratio

Screen size				Distance from screen (mm)			Lowest/ Highest Lens position (mm)
Diagonal		H (mm)	W (mm)	Min length	Average	Max length	
Inch	mm			(max. zoom)		(min. zoom)	
80	2032	996	1771	2400	3000	3600	149
90	2286	1121	1992	2700	3375	4050	168
100	2540	1245	2214	3000	3750	4500	187
110	2794	1370	2435	3300	4125	4950	205
120	3048	1494	2657	3600	4500	5400	224
130	3302	1619	2878	3900	4875	5850	243
140	3556	1743	3099	4200	5250	6300	262
150	3810	1868	3321	4500	5625	6750	280
160	4064	1992	3542	4800	6000	7200	299
170	4318	2117	3763	5100	6375	7650	318
180	4572	2241	3985	5400	6750	8100	336
190	4826	2366	4206	5700	7125	8550	355
200	5080	2491	4428	6000	7500	9000	374

For example, if you are using a 120-inch screen, the recommended projection distance is 4500 mm.

If your measured projection distance is 520 cm, the closest match in the "Distance from screen (mm)" column is 5250 mm. Looking across this row shows that a 140" (about 3.6 m) screen is required.



All measurements are approximate and may vary from the actual sizes.

BenQ recommends that if you intend to permanently install the projector, you should physically test the projection size and distance using the actual projector in situ before you permanently install it, so as to make allowance for this projector's optical characteristics. This will help you determine the exact mounting position so that it best suits your installation location.

## Mounting the projector

If you intend to mount your projector, we strongly recommend that you use a proper fitting BenQ projector mounting kit and that you ensure it is securely and safely installed.

If you use a non-BenQ brand projector mounting kit, there is a safety risk that the projector may fall down due to an improper attachment through the use of the wrong gauge or length screws.

### Before mounting the projector

- Purchase a BenQ projector mounting kit from the place you purchased your BenQ projector.
- BenQ recommends that you also purchase a separate Kensington lock compatible security cable and attach it securely to both the Kensington lock slot on the projector and the base of the mounting bracket. This will perform the secondary role of restraining the projector should its attachment to the mounting bracket become loose.
- Ask your dealer to install the projector for you. Installing the projector on your own may cause it to fall and result in injury.
- Take necessary procedures to prevent the projector from falling off such as during an earthquake.
- The warranty doesn't cover any product damage caused by mounting the projector with a non-BenQ brand projector mounting kit.
- Consider the surrounding temperature where the projector is ceiling mounted. If a heater is used, the temperature around the ceiling may be higher than expected.
- Read the user manual for the mounting kit about the range of torque. Tightening with torque exceeding the recommended range may cause damage to the projector and subsequently falling off.
- Make sure the power outlet is at an accessible height so that you can easily shut down the projector.

### Ceiling mount installation diagram

Ceiling mount screw: M4  
(Max L = 25 mm; Min L = 20 mm)

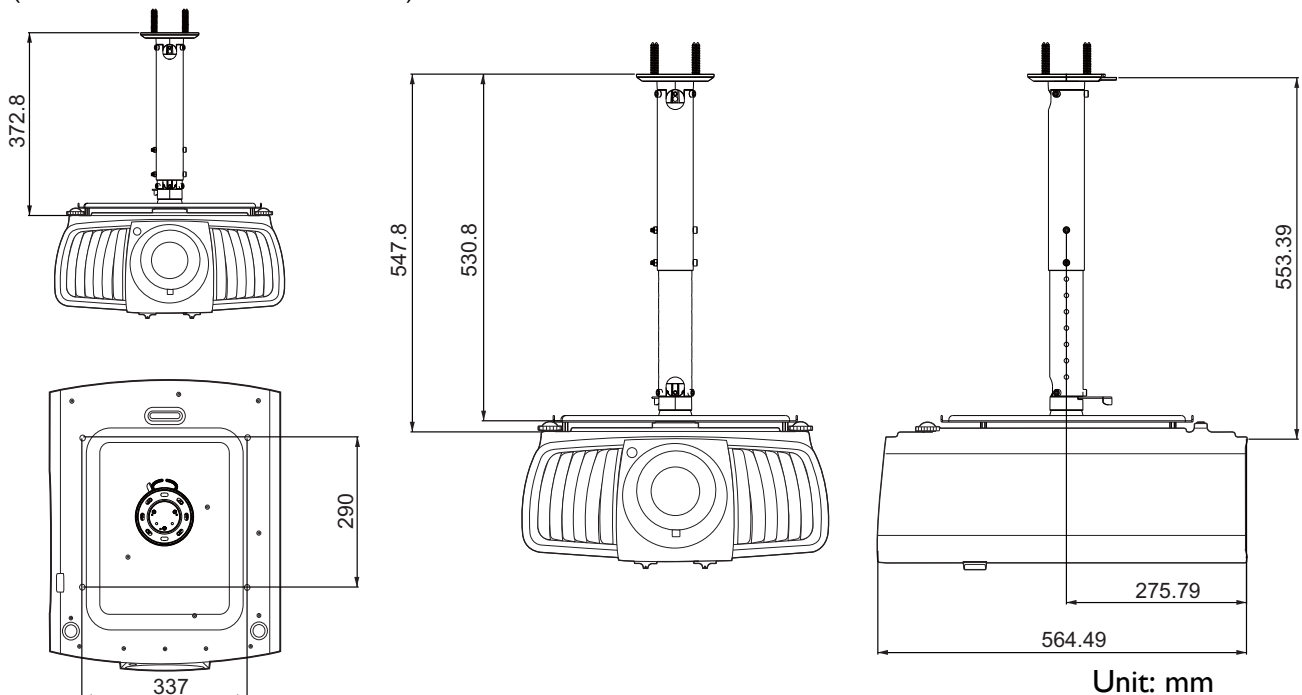

# Adjusting the projector position

## Shifting the projection lens

The lens shift control provides flexibility for installing your projector. It allows the projector to be positioned off the center of the screen.

The lens shift is expressed as a percentage of the projected image height or width. You can turn the knobs on the projector to shift the projection lens in any direction within the allowable range depending on your desired image position.

### The horizontal position

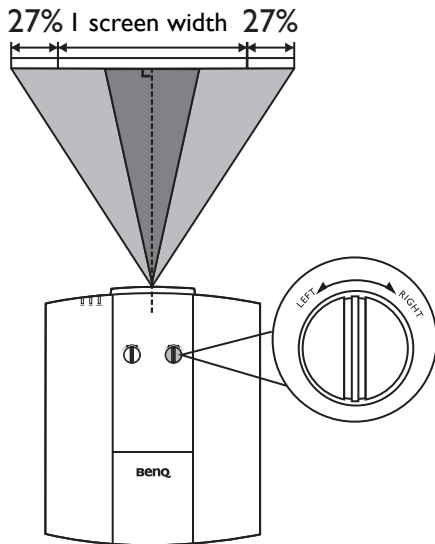

### The vertical position

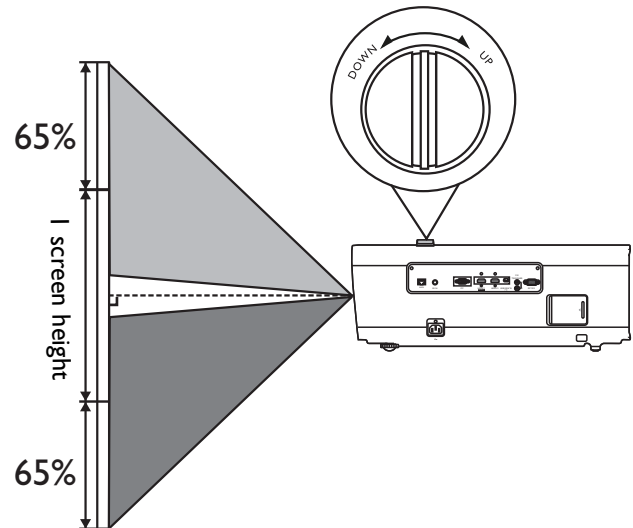

### The projection range

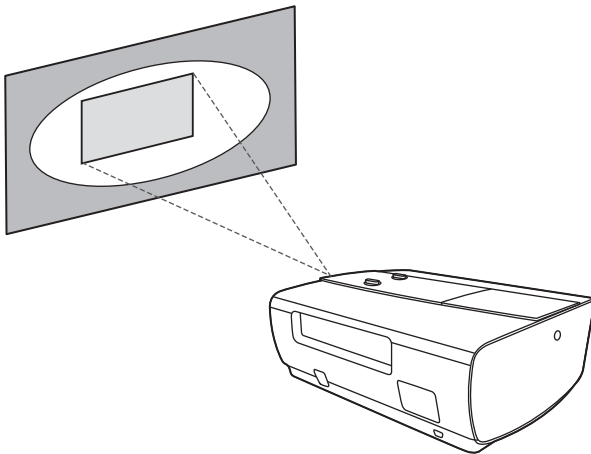

 Lens shift adjustment will not result in a degraded picture quality.

## Adjusting the projected image

### Adjusting the projection angle

If the projector is not placed on a flat surface or the screen and the projector are not perpendicular to each other, the projected image becomes trapezoidal. You can screw the adjuster feet to fine-tune the horizontal angle.

To retract the feet, screw the adjuster feet in a reverse direction.

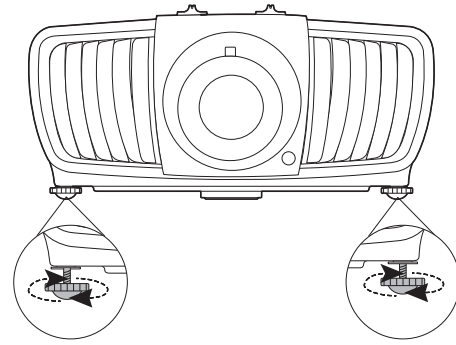

**!** Do not look into the lens while the lamp is on. The strong light from the lamp may cause damage to your eyes.

### Auto-adjusting the image

In some cases, you may need to optimize the picture quality. To do this, press **AUTO**. Within 3 seconds, the built-in Intelligent Auto Adjustment function will re-adjust the values of Frequency and Clock to provide the best picture quality.

The current source information will be displayed in the corner of the screen for 3 seconds.

**!** This function is only available when PC signal (analog RGB) is selected.

### Fine-tuning the image size and clarity

1. Adjust the projected image to the size that you need using the zoom ring.
2. Sharpen the image by rotating the focus ring.

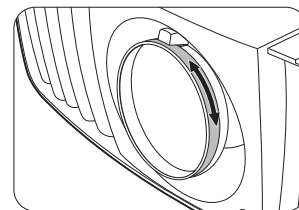
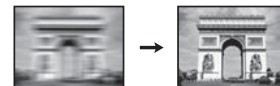
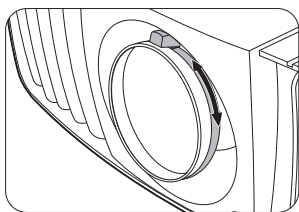

# Connection

When connecting a signal source to the projector, be sure to:

1. Turn all equipment off before making any connections.
2. Use the correct signal cables for each source.
3. Ensure the cables are firmly inserted.

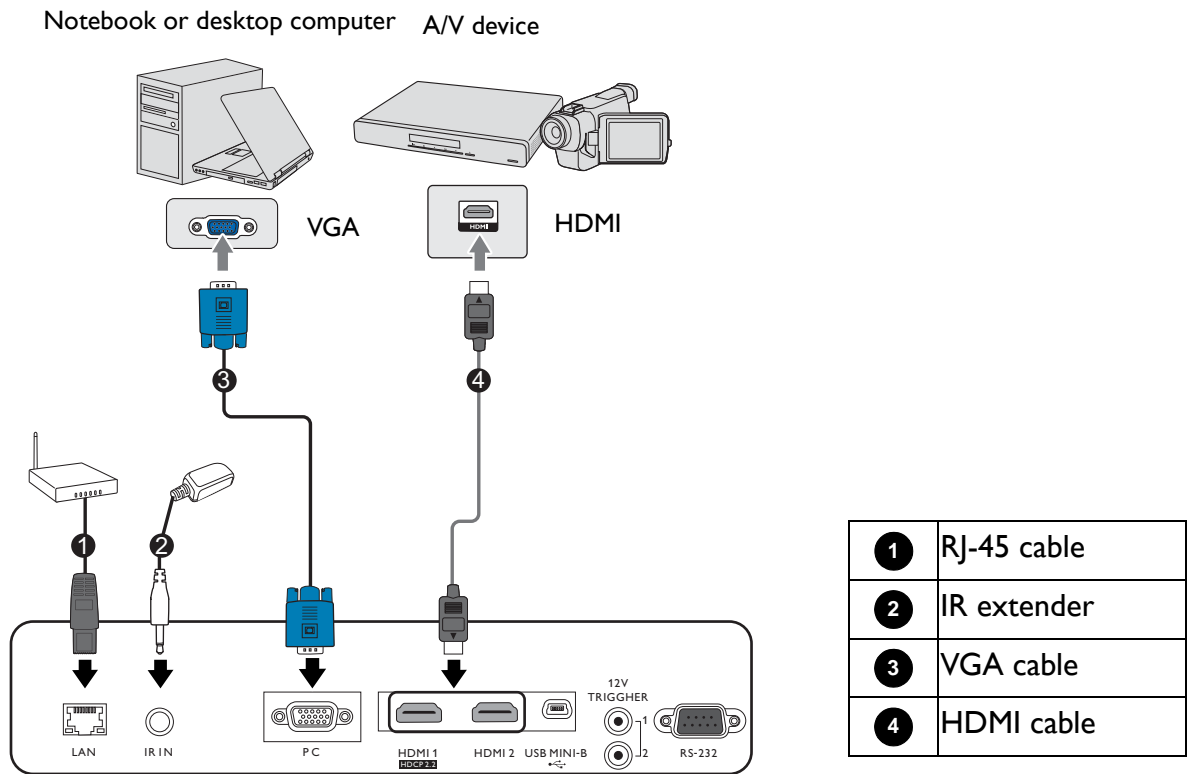

- In the connections above, some cables may not be included with the projector (see [Shipping contents on page 7](#)). They are commercially available from electronics stores.
- The connection illustrations are for reference only. The rear connecting jacks available on the projector vary with each projector model.
- Many notebooks do not turn on their external video ports when connected to a projector. Usually a key combo like FN + function key with a monitor symbol turns the external display on/off. Press FN and the labeled function key simultaneously. Refer to your notebook's documentation to find your notebook's key combination.
- If the selected video image is not displayed after the projector is turned on and the correct video source has been selected, check that the video source device is turned on and operating correctly. Also check that the signal cables have been connected correctly.

You need only connect the projector to a video source device using just one of the connecting methods, however each provides a different level of video quality.

Terminal		Picture quality
HDMI 1 (Version 2.0)		Best
HDMI 2 (Version 1.4a)		Better
PC		Good



## Using the cable tie set

The cable tie set helps prevent a cable plug from falling out of the connecting port. It contains the following parts.

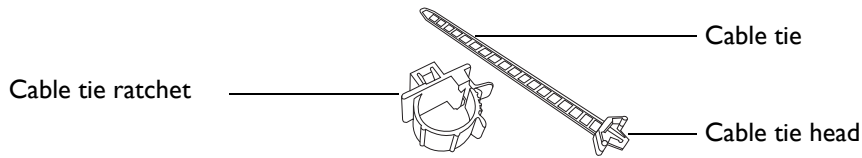

To use the cable tie set:

1. Firmly plug a cable to a correct port on the projector. Insert the cable tie head to the cable tie hole right above the connecting port. Note that the cable tie cannot be removed from the hole once it is inserted.

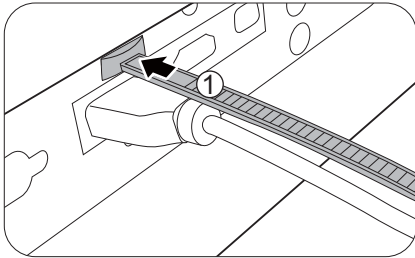

3. Insert the end of the cable tie to the cable tie ratchet as illustrated.
4. Close the cable tie ratchet by pressing its tab.

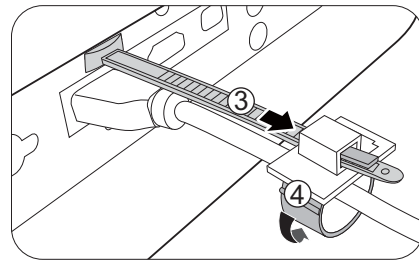

2. Take the cable tie ratchet. Slightly open the ratchet to surround the connecting cable.

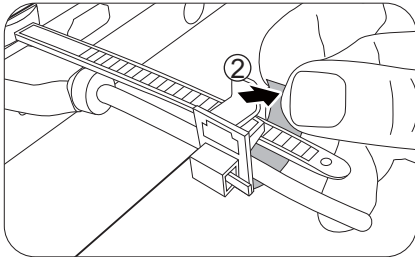

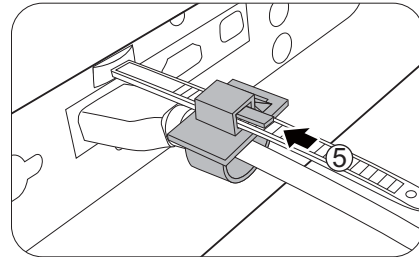

5. Move the cable tie ratchet along with the cable tie to the end of the cable plug.



The cable tie installation is done.





# Operation

## Starting up the projector

1. Plug the power cord. Turn on the power outlet switch (where fitted). The power indicator on the projector lights orange after power has been applied.
2. Press  on the projector or  on the remote control to start the projector. The power indicator flashes green and stays green when the projector is on.

The start up procedure takes about 30 seconds. In the later stage of start up, a startup logo is projected.

(If necessary) Rotate the focus ring to adjust the image clearness.

3. If this is the first time you turn on the projector, the setup wizard appears to guide you through setting up the projector. If you have already done this, skip this step and move on to the next step.
  - Use the arrow keys (/ / / ) on the projector or remote control to move through the menu items.
  - Use **OK** to confirm the selected menu item.

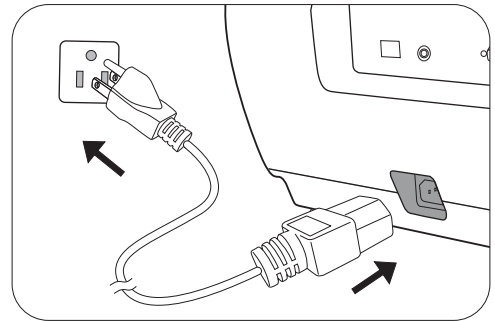

Step 1:

Specify **Projector Position**.

For more information about projector position, see [Choosing a location](#).

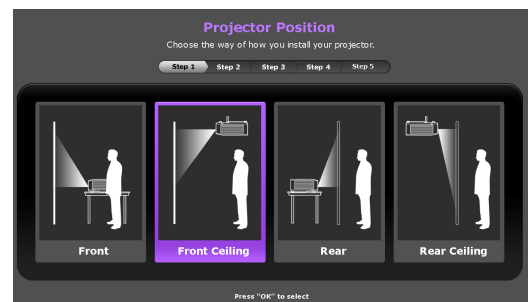

Step 2:

Specify OSD **Language**.



Step 3:

Specify **Auto Source**.

Select **On** if you want the projector to always search for available signals automatically when the projector is turned on.

Now you've completed the initial setup.



4. If you are prompted for a password, press the arrow keys to enter a 6-digit password. See [Utilizing the password function on page 21](#).
5. Switch all of the connected equipment on.
6. The projector will search for input signals. The current input signal being scanned appears. If the projector does not detect a valid signal, the message “No Signal” will continue displaying until an input signal is found.

You can also press **SOURCE** to select your desired input signal. See [Switching input signal on page 22](#).



- Please use the original accessories (e.g. power cord) to avoid possible dangers such as electric shock and fire.
- If the projector is still hot from previous activity, it will run the cooling fan for approximately 90 seconds before energizing the lamp.



- 
- The Setup Wizard screenshots are for reference only and may differ from the actual design.
  - If the frequency/resolution of the input signal exceeds the projector's operating range, you will see the message “Out of Range” displayed on the background screen. Please change to an input signal which is compatible with the projector's resolution or set the input signal to a lower setting. See [Timing chart on page 41](#).
  - If no signal is detected for 3 minutes, the projector automatically enters saving mode.

# Using the menus

The projector is equipped with On-Screen Display (OSD) menus for making various adjustments and settings.

 The OSD screenshots below are for reference only, and may differ from the actual design.

Below is the overview of the OSD menu.

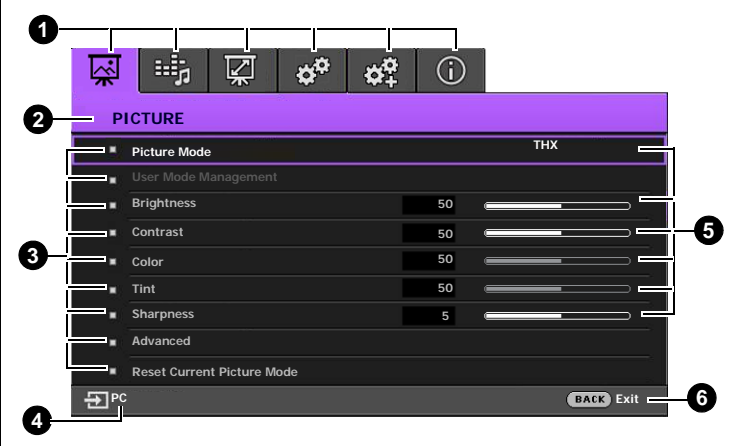
	<p><b>1</b> Main menu icon</p>	<p><b>4</b> Current input signal</p>
<p><b>2</b> Main menu</p>	<p><b>2</b> Main menu</p>	<p><b>5</b> Status</p>
<p><b>3</b> Sub-menu</p>	<p><b>3</b> Sub-menu</p>	<p><b>6</b> Press <b>BACK</b> to go to the previous page or to exit.</p>

To access the OSD menu, press **MENU** on the projector or remote control.

- Use the arrow keys (▲/▼/◀/▶) on the projector or remote control to move through the menu items.
- Use **OK** on the projector or remote control to confirm the selected menu item.

# Securing the projector

## Using a security cable lock

The projector has to be installed in a safe place to prevent theft. Otherwise, purchase a lock, such as the Kensington lock, to secure the projector. You can locate a Kensington lock slot on the rear side of the projector. See item 22 on [page 8](#).

A Kensington security cable lock is usually a combination of key(s) and the lock. Refer to the lock's documentation for finding out how to use it.

## Utilizing the password function

### Setting a password

1. Go to **SYSTEM SETUP: ADVANCED > Password**. Press **OK**. The **Password** page appears.
2. Highlight **Change Password** and press **OK**.
3. The four arrow keys (**▲**, **▶**, **▼**, **◀**) respectively represent 4 digits (1, 2, 3, 4). According to the password you desire to set, press the arrow keys to enter six digits for the password.
4. Confirm the new password by re-entering the new password.  
Once the password is set, the OSD menu returns to the **Password** page.
5. To activate the **Power On Lock** function, press **▲/▼** to highlight **Power On Lock** and press **◀/▶** to select **On**. Input the password again.

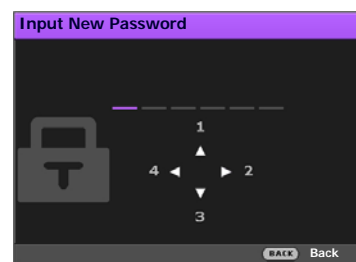

- The digits being input will display as asterisks on-screen. Make a note of your selected password and keep it in a safe place in advance or right after the password is entered so that it is available to you should you ever forget it.
- Once a password has been set and the power on lock is activated, the projector cannot be used unless the correct password is entered every time the projector is started.

### If you forget the password

If you enter the wrong password, the password error message will appear, and the **Input Current Password** message follows. If you absolutely do not remember the password, you can use the password recall procedure. See [Entering the password recall procedure on page 21](#).

If you enter an incorrect password 5 times in succession, the projector will automatically shut down in a short time.

### Entering the password recall procedure

1. Press and hold **OK** for 3 seconds. The projector will display a coded number on the screen.
2. Write down the number and turn off your projector.
3. Seek help from the local BenQ service center to decode the number. You may be required to provide proof of purchase documentation to verify that you are an authorized user of the projector.

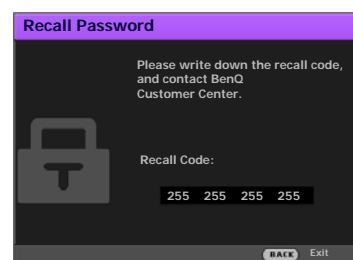
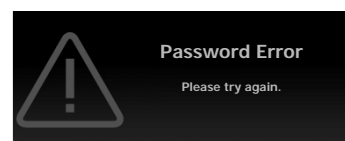

## Changing the password

1. Go to **SYSTEM SETUP: ADVANCED > Password > Change Password**.
2. Press **OK**. The message “**Input Current Password**” appears.
3. Enter the old password.
  - If the password is correct, another message “**Input New Password**” appears.
  - If the password is incorrect, the password error message will appear, and the message “**Input Current Password**” appears for your retry. You can press **BACK** to cancel the change or try another password.
4. Enter a new password.
5. Confirm the new password by re-entering the new password.

## Disabling the password function

To disable password protection, go to **SYSTEM SETUP: ADVANCED > Password > Power On Lock** and press **◀/▶** to select **Off**. The message “**Input Current Password**” appears. Enter the current password.

- If the password is correct, the OSD menu returns to the **Password** page. You will not have to enter the password next time turning on the projector.
- If the password is incorrect, the password error message will appear, and the message “**Input Current Password**” appears for your retry. You can press **BACK** to cancel the change or try another password.



Though the password function is disabled, you need to keep the old password in hand should you ever need to re-activate the password function by entering the old password.

## Switching input signal

The projector can be connected to multiple devices at the same time. However, it can only display one full screen at a time. When starting up, the projector automatically searches for the available signals.

Be sure the **SYSTEM SETUP: BASIC > Auto Source** menu is **On** if you want the projector to automatically search for the signals.

To select the source:



1. Press **SOURCE**. A source selection bar appears.
2. Press **▲/▼** until your desired signal is selected and press **OK**.

Once detected, the selected source information will appear at the corner of the screen for seconds. If there is multiple equipment connected to the projector, repeat steps 1-2 to search for another signal.



- The brightness level of the projected image will change accordingly when you switch between different input signals.
- For best display picture results, you should select and use an input signal which outputs at the projector's native resolution. Any other resolutions will be scaled by the projector depending upon the “aspect ratio” setting, which may cause some image distortion or loss of picture clarity. See [Aspect Ratio on page 28](#).

## Shutting down the projector

1. Press  and a confirmation message will appear prompting you. If you don't respond in a few seconds, the message will disappear.
2. Press  a second time. The power indicator flashes orange, the projection lamp shuts down, and the fans will continue to run for approximately 90 seconds to cool down the projector.
3. Once the cooling process finishes, the power indicator becomes a steady orange and fans stop. Disconnect the power cord from the power outlet.

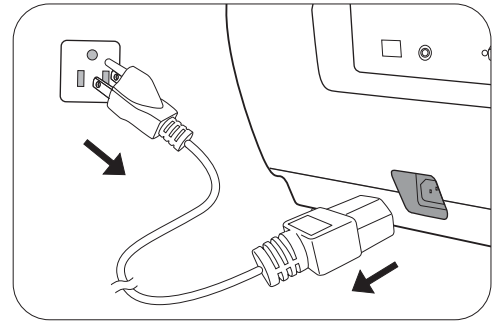

- To protect the lamp, the projector will not respond to any commands during the cooling process.
- To shorten the cooling time, you can also activate the [Quick cooling function](#). See [Quick Cooling on page 30](#).
- Avoid turning on the projector immediately after turning it off as excessive heat may shorten lamp life.
- Lamp life results will vary depending on environmental conditions and usage.

## Direct power off

The AC power cord can be pulled out right after the projector is turned off. To protect the lamp, wait about 10 minutes before re-starting the projector. If you attempt to re-start the projector, the fans may run for a few minutes to cool down. In such cases, press  **POWER** again to start the projector after the fans stop and the power indicator turns orange.

# Menu operation

Please note that the on-screen display (OSD) menus vary according to the signal type selected and the projector model you are using.

The menu items are available when the projector detects at least one valid signal. If there is no equipment connected to the projector or no signal detected, limited menu items are accessible.

## PICTURE menu

<p><b>Picture Mode</b></p>	<p>The projector is preset with several predefined picture modes so that you can choose one to suit your operating environment and input signal picture type.</p> <ul style="list-style-type: none"> <li>• <b>Bright:</b> Maximizes the brightness of the projected image. This mode is suitable for environments where extra-high brightness is required, such as using the projector in well lit rooms.</li> <li>• <b>Vivid:</b> Being slightly brighter than <b>Cinema</b> mode, it is suitable for playing movies in rooms where there is a small amount of ambient light, e.g. your living room.</li> <li>• <b>Cinema:</b> With well-balanced color saturation and contrast with a low brightness level, this is most suitable for enjoying movies in a totally dark environment (as you would find in a commercial cinema).</li> <li>• <b>THX:</b> A color mode and image quality certified by THX Ltd.</li> <li>• <b>Silence:</b> Minimizes the acoustic noise. It is suitable for the need of watching movies that requires an ultra-quiet environment so that you won't be disturbed by the noise of the projector. When this mode is used, the following menu functions will be automatically changed to the designated settings and grayed out.             <ul style="list-style-type: none"> <li>• <b>XPR: Off</b> (The display resolution will be 2716 x 1528.)</li> <li>• <b>Dynamic Iris: Off</b></li> <li>• <b>Light Mode: Economic</b></li> </ul> </li> <li>• <b>User 1/User 2:</b> Recalls the settings customized based on the current available picture modes. See <a href="#">User Mode Management on page 24</a>.</li> </ul>
<p><b>User Mode Management</b></p>	<p>There are two user-definable modes if the current available picture modes are not suitable for your need. You can use one of the picture modes (except the <b>User 1/User 2</b>) as a starting point and customize the settings.</p> <ul style="list-style-type: none"> <li>• <b>Load Settings From</b> <ol style="list-style-type: none"> <li>1. Go to <b>PICTURE &gt; Picture Mode</b>.</li> <li>2. Press <b>◀/▶</b> to select <b>User 1</b> or <b>User 2</b>.</li> <li>3. Press <b>▼</b> to highlight <b>User Mode Management</b>, and press <b>OK</b>. The <b>User Mode Management</b> page is displayed.</li> <li>4. Select <b>Load Settings From</b> and press <b>OK</b>.</li> <li>5. Press <b>▼/▲</b> to select a picture mode that is closest to your need.</li> <li>6. Press <b>OK</b> and <b>BACK</b> to return to the <b>PICTURE</b> menu.</li> <li>7. Press <b>▼</b> to select the sub-menu items you want to change and adjust the values with <b>◀/▶</b>. The adjustments define the selected user mode.</li> </ol> </li> </ul>



<p><b>User Mode Management (Continued)</b></p>	<p>• <b>Rename User Mode</b></p> <p>Select to rename the customized picture modes (<b>User 1</b> or <b>User 2</b>). The new name can be up to 9 characters including English letters (A-Z, a-z), digits (0-9), and space ( ).</p> <ol style="list-style-type: none"> <li>1. Go to <b>PICTURE &gt; Picture Mode</b>.</li> <li>2. Press <b>◀/▶</b> to select <b>User 1</b> or <b>User 2</b>.</li> <li>3. Press <b>▼</b> to highlight <b>User Mode Management</b>, and press <b>OK</b>. The <b>User Mode Management</b> page is displayed.</li> <li>4. Press <b>▼</b> to highlight <b>Rename User Mode</b> and press <b>OK</b>. The <b>Rename User Mode</b> page is displayed.</li> <li>5. Use <b>▲/▶/▼/◀</b> to select desired characters.</li> <li>6. When done, press <b>OK</b> and <b>BACK</b> to exit.</li> </ol>
<p><b>Brightness</b></p>	<p>The higher the value, the brighter the image. Adjust this control so the black areas of the image appear just as black and that detail in the dark areas is visible.</p>
<p><b>Contrast</b></p>	<p>The higher the value, the greater the contrast. Use this to set the peak white level after you have previously adjusted the Brightness setting to suit your selected input and viewing environment.</p>
<p><b>Color</b></p>	<p>Lower setting produces less saturated colors. If the setting is too high, colors on the image will be overpowering, which makes the image unrealistic.</p>
<p><b>Tint</b></p>	<p>The higher the value, the more greenish the picture becomes. The lower the value, the more reddish the picture becomes.</p>
<p><b>Sharpness</b></p>	<p>The higher the value, the sharper the picture becomes.</p>
<p><b>Advanced</b></p>	<p>• <b>Gamma Selection</b></p> <p>Gamma refers to the relationship between input source and picture brightness.</p> <ul style="list-style-type: none"> <li>• <b>1.6/1.8/2.0/2.1/BenQ</b>: Select these values according to your preference.</li> <li>• <b>2.2/2.3</b>: Increases the average brightness of the picture. Best for a lit environment, meeting room or family room.</li> <li>• <b>2.4/2.5</b>: Best for viewing movies in a dark environment.</li> <li>• <b>2.6/2.8</b>: Best for viewing movies which are mostly composed of dark scenes.</li> </ul> <div style="text-align: center;"> <p>High Brightness Low Contrast</p>  <p>Low Brightness High Contrast</p> </div>

Advanced  
(Continued)

• **Color Temperature**

There are several preset color temperature settings available. The available settings may vary according to the signal type selected.

- **Normal:** Maintains normal colorings for white.
- **Cool:** Makes images appear bluish white.
- **Lamp Native:** With the lamp's original color temperature and higher brightness. This setting is suitable for environments where high brightness is required, such as projecting pictures in well lit rooms.
- **Warm:** Makes images appear reddish white.

You can also set a preferred color temperature by adjusting the following options.

- **R Gain/G Gain/B Gain:** Adjusts the contrast levels of Red, Green, and Blue.
- **R Offset/G Offset/B Offset:** Adjusts the brightness levels of Red, Green, and Blue.

• **Color Management**

The Color Management provides six sets (RGBCMY) of colors to be adjusted. When you select each color, you can independently adjust its range and saturation according to your preference.

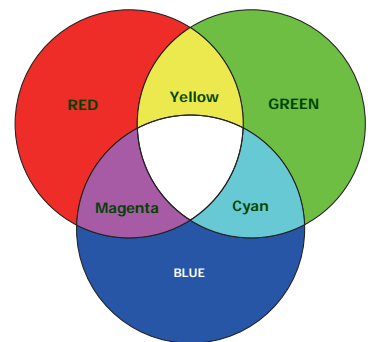

- **Primary Color:** Selects a color from among Red, Yellow, Green, Cyan, Blue, or Magenta.
- **Hue:** Increase in the range will include colors consisted of more proportions of its two adjacent colors. Please refer to the illustration for how the colors relate to each other. For example, if you select Red and set its range at 0, only pure red in the projected picture will be selected. Increasing its range will include red close to yellow and red close to magenta.
- **Gain:** Adjusts the values to your preference. The contrast level of the primary color you select will be affected. Every adjustment made will reflect to the image immediately.
- **Saturation:** Adjusts the values to your preference. Every adjustment made will reflect to the image immediately. For example, if you select Red and set its value at 0, only the saturation of pure red will be affected.





**Saturation** is the amount of that color in a video picture. Lower settings produce less saturated colors; a setting of "0" removes that color from the image entirely. If the saturation is too high, that color will be overpowering and unrealistic.



<p><b>Advanced (Continued)</b></p>	<ul style="list-style-type: none"> <li>• <b>CinemaMaster</b> <ul style="list-style-type: none"> <li>• <b>Color Enhancer:</b> Allows you to fine-tune the saturation of colors with larger flexibility. It modulates complex color algorithms to flawlessly render saturated colors, fine gradients, intermediate hues and subtle pigments.</li> <li>• <b>Flesh Tone:</b> Provides a smart adjustment of hue only for calibrating people's skin color, not other colors in the image. It prevents discoloration of skin tones from the light of the projection beam, portraying every skin tone in its most beautiful shade.</li> <li>• <b>Pixel Enhancer 4K:</b> It is a super-resolution technology which radically enhances Full HD content in terms of colors, contrast, and textures. It's also a Detail Enhancement Technology refines surface details for true-to-life images that pop off the screen. Users can adjust levels of sharpness and detail enhancement for optimal viewing.</li> <li>• <b>DCTI/DLTI:</b> Sophisticated algorithms significantly improve color and light output when producing images with contrasting colors or bright and dark scales. <b>DCTI</b> heightens color vibrancy for drastic color transitions without noise interference. <b>DLTI</b> reduces noise from fast switching of varied luminance to optimized brightness and contrast. The result is picture quality with the utmost picture depth and color performance.</li> </ul> </li> <li>• <b>Noise Reduction:</b> Reduces electrical image noise caused by different media players. The higher the value, the less the noise.</li> <li>• <b>Dynamic Iris:</b> Automatically changes the black level of the projected pictures to enhance the effect of contrast ratio.</li> <li>• <b>Brilliant Color:</b> This feature utilizes a new color-processing algorithm and system level enhancements to enable higher brightness while providing truer, more vibrant colors in picture. It enables a greater than 50% brightness increase in mid-tone images, which are common in video and natural scenes, so the projector reproduces images in realistic and true colors. If you prefer images with that quality, select <b>On</b>. When <b>Off</b> is selected, the <b>Color Temperature</b> function is not available.</li> <li>• <b>Light Mode:</b> Selects a suitable lamp power from among the provided modes. See <a href="#">Extending lamp life on page 33</a>.</li> </ul>
<p><b>Reset Current Picture Mode</b></p>	<p>Returns all of the adjustments you've made for the selected <b>Picture Mode</b> (including preset modes, <b>User 1</b>, and <b>User 2</b>) to the factory preset values.</p> <ol style="list-style-type: none"> <li>1. Press <b>OK</b>. The confirmation message is displayed.</li> <li>2. Use <b>◀/▶</b> to select <b>Reset</b> and press <b>OK</b>. The current picture mode returns to the factory preset settings.</li> </ol>

## DISPLAY menu

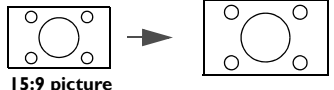
<b>Image Position</b>	Displays the position adjustment page. To move the projected image, use the directional arrow keys. This function is only available when a PC signal (analog RGB) is selected.
<b>Overscan Adjustment</b>	Conceals the poor picture quality in the four edges. The greater the value, the more portion of the picture is concealed while the screen remains filled and geometrically accurate. Setting 0 means the picture is 100% displayed.
<b>PC Tuning</b>	<ul style="list-style-type: none"> <li>• <b>H. Size:</b> Adjusts the horizontal width of the image.</li> <li>• <b>Phase:</b> Adjusts the clock phase to reduce image distortion.</li> <li>• <b>Auto:</b> Adjusts the phase and frequency automatically.</li> </ul>   <p>These functions are only available when the PC signal is selected.</p>

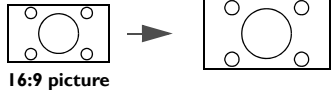
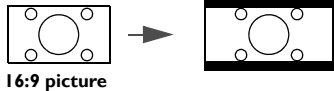
## INSTALLATION menu

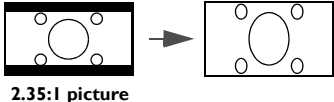
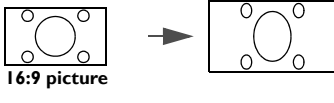
<b>Projector Position</b>	The projector can be installed on a ceiling or behind a screen, or with one or more mirrors. See <a href="#">Choosing a location on page 11</a> .
<b>Test Pattern</b>	Adjusts the image size and focus and check that the projected image is free from distortion.
<b>Aspect Ratio</b>	<p>There are several options to set the image's aspect ratio depending on your input signal source.</p> <ul style="list-style-type: none"> <li>• <b>Auto:</b> Scales an image proportionally to fit the projector's native resolution in its horizontal or vertical width.</li> <li>• <b>4:3:</b> Scales an image so that it is displayed in the center of the screen with a 4:3 aspect ratio.</li> <li>• <b>16:9:</b> Scales an image so that it is displayed in the center of the screen with a 16:9 aspect ratio.</li> <li>• <b>2.35:1:</b> Scales an image so that it is displayed in the center of the screen with a 2.35:1 aspect ratio.</li> </ul>    

<p><b>Aspect Ratio (Continued)</b></p>	<ul style="list-style-type: none"> <li>• <b>Anamorphic 2.35:1:</b> Vertically stretches an image to fit the anamorphic lens. It keeps the native resolution in its horizontal width and resizes the resolution in its vertical height to 1.32 times of the original image.</li> <li>• <b>Anamorphic 16:9:</b> Horizontally squeezes an image to fit the anamorphic lens. It keeps the native resolution in its vertical height and resizes the resolution in its horizontal width to 0.75 times of the original image.</li> </ul>  
<p><b>12V Trigger</b></p>	<p>There are two 12V triggers that work independently according to your needs for installation scenarios. Three selections are available:</p> <ul style="list-style-type: none"> <li>• <b>Off:</b> If this is selected, the projector will not send electronic signal out when it is turned on.</li> <li>• <b>Power:</b> The projector will send a low to high electronic signal out when it is turned on, a high to low signal out when it is turned off.</li> <li>• <b>Anamorphic:</b> The projector will send a low to high electronic signal out when the aspect ratio is switched from other aspect ratios to "<b>Anamorphic 2.35:1</b>" or "<b>Anamorphic 16:9</b>", a high to low signal out when the aspect ratio setting is switched from "<b>Anamorphic 2.35:1</b>" or "<b>Anamorphic 16:9</b>" to other aspect ratios.</li> </ul>
<p><b>High Altitude Mode</b></p>	<p>We recommend you use the <b>High Altitude Mode</b> when your environment is between 1500 m –3000 m above sea level, and ambient temperature is between 0°C–30°C.</p> <p>Operation under "<b>High Altitude Mode</b>" may cause a higher decibel operating noise level because of increased fan speed necessary to improve overall system cooling and performance.</p> <p>If you use this projector under other extreme conditions excluding the above, it may display auto shut-down symptoms, which is designed to protect your projector from over-heating. In cases like this, you should switch to High Altitude mode to solve these symptoms. However, this is not to state that this projector can operate under any and all harsh or extreme conditions.</p>  <p>Do not use the <b>High Altitude Mode</b> if your altitude is between 0 m and 1500 m and ambient temperature is between 0°C and 35°C. The projector will be over cooled, if you turn the mode on under such a condition.</p>





## SYSTEM SETUP: BASIC menu

<p><b>Language</b></p>	<p>Sets the language for the On-Screen Display (OSD) menus.</p>
<p><b>Background Color</b></p>	<p>Sets the background color for the projector.</p>
<p><b>Splash Screen</b></p>	<p>Allows you to select which logo screen will be displayed during projector start-up.</p>
<p><b>Auto Off</b></p>	<p>Allows the projector to turn off automatically if no input signal is detected after a set period of time to prevent unnecessary waste of lamp life.</p>
<p><b>Direct Power On</b></p>	<p>Allows the projector to turn on automatically once the power is fed through the power cord.</p>

<b>Menu Settings</b>	<ul style="list-style-type: none"> <li>• <b>Menu Position:</b> Sets the On-Screen Display (OSD) menu position.</li> <li>• <b>Menu Display Time:</b> Sets the length of time the OSD will remain active after your last key press.</li> <li>• <b>Reminder Message:</b> Sets the reminder messages on or off.</li> </ul>
<b>Source Rename</b>	<p>Renames the current input source to your desired name.</p> <p>On the <b>Source Rename</b> page, use ▲/▼/◀/▶ to set the desired characters for the connected source item.</p> <p>When done, press <b>OK</b> to save the changes.</p>
<b>Auto Source</b>	Allows the projector to automatically search for a signal.

## SYSTEM SETUP: ADVANCED menu

<b>Lamp Settings</b>	<ul style="list-style-type: none"> <li>• <b>Reset Lamp Timer:</b> See <a href="#">Resetting the lamp timer on page 36</a>.</li> <li>• <b>Lamp Timer:</b> See <a href="#">Getting to know the lamp hour on page 32</a>.</li> </ul>						
<b>HDMI Settings</b>	<ul style="list-style-type: none"> <li>• <b>HDMI Range</b> Selects a suitable RGB color range to correct the color accuracy. <ul style="list-style-type: none"> <li>• <b>Auto:</b> Automatically selects a suitable color range for the incoming HDMI signal.</li> <li>• <b>Full Range:</b> Utilizes the Full range RGB 0-255.</li> <li>• <b>Limited Range:</b> Utilizes the Limited range RGB 16-235.</li> </ul> </li> <li>• <b>CEC</b> When you connect an HDMI CEC-compatible device to your projector with an HDMI cable, turning on the HDMI CEC compatible device automatically turns on the projector, while turning off the projector automatically turns off the HDMI CEC compatible device.</li> <li>• <b>Power On Link/Power Off Link</b> When you connect an HDMI CEC-compatible device to your projector with an HDMI cable, you can set the behavior of powering on/off between the device and the projector. <table border="1" data-bbox="384 1473 1461 1720"> <tr> <td><b>Bidirectional</b></td> <td>Turning on/off either the connected device or the projector can turn on/off both.</td> </tr> <tr> <td><b>From Projector</b></td> <td>When the projector is turned on/off, the connected device will be activated/shut down, too.</td> </tr> <tr> <td><b>From Device</b></td> <td>When the connected device is turned on/off, the projector will be activated/shut down, too.</td> </tr> </table> </li> </ul>	<b>Bidirectional</b>	Turning on/off either the connected device or the projector can turn on/off both.	<b>From Projector</b>	When the projector is turned on/off, the connected device will be activated/shut down, too.	<b>From Device</b>	When the connected device is turned on/off, the projector will be activated/shut down, too.
<b>Bidirectional</b>	Turning on/off either the connected device or the projector can turn on/off both.						
<b>From Projector</b>	When the projector is turned on/off, the connected device will be activated/shut down, too.						
<b>From Device</b>	When the connected device is turned on/off, the projector will be activated/shut down, too.						
<b>Quick Cooling</b>	Enables or disables the Quick Cooling function. Selecting <b>On</b> enables the function and projector cooling time will be shortened from a normal 90-second duration to approximately 15 seconds.						
<b>Password</b>	See <a href="#">Utilizing the password function on page 21</a> .						

<p><b>Key Lock</b></p>	<p>With the control keys on the projector and remote control locked, you can prevent your projector settings from being changed accidentally (by children, for example). When the <b>Key Lock</b> is on, no control keys on the projector will operate except  <b>POWER</b>.</p> <p>To release panel key lock, press and hold ► (the right key) on the projector or remote control for 3 seconds.</p> <p></p> <p>If you turn off the projector without disabling panel key lock, the projector will still be in locked status the next time it is turned on.</p>
<p><b>LED Indicator</b></p>	<p>Selects to turn off the LED warning lights. This is to avoid any light disturbance when viewing images in a dark room.</p>
<p><b>Network Settings</b></p>	<ul style="list-style-type: none"> <li>• <b>Wired LAN:</b> See <a href="#">BenQ Network Projector Operation Guide</a>.</li> <li>• <b>AMX Device Discovery:</b> When this function is <b>On</b>, the projector can be detected by AMX controller.</li> <li>• <b>Network Standby:</b> When this function is <b>On</b>, the projector is able to provide the network function when it is in standby mode.</li> <li>• <b>MAC Address:</b> Displays the mac address for this projector.</li> </ul>
<p><b>Reset All Settings</b></p>	<p>Returns all settings to the factory preset values.</p> <p></p> <p>The following settings will still remain: <b>Picture Mode, User Mode Management, Brightness, Contrast, Color, Tint, Sharpness, Advanced, Projector Position, Source Rename, Password, and Network Settings.</b></p>
<p><b>ISF</b></p>	<p>The ISF calibration menu is password protected and only accessible by authorized ISF calibrators. The ISF (Imaging Science Foundation) has developed carefully crafted, industry-recognized standards for optimal video performance and has implemented a training program for technicians and installers to use these standards to obtain optimal picture quality from BenQ video display devices. Accordingly, we recommend that setup and calibration be performed by an ISF certified installation technician.</p> <p></p> <p>For more information, go to <a href="http://www.imagingscience.com">www.imagingscience.com</a> or contact the dealer or retailer from whom you purchased the projector.</p>

## INFORMATION menu

<p><b>Current System Status</b></p>	<ul style="list-style-type: none"> <li>• <b>Source:</b> Shows the current signal source.</li> <li>• <b>Picture Mode:</b> Shows the selected mode in the <b>PICTURE</b> menu.</li> <li>• <b>Resolution:</b> Shows the native resolution of the input signal.</li> <li>• <b>Color System:</b> Shows input system format.</li> <li>• <b>Lamp Usage Time:</b> Shows the number of hours the lamp has been used.</li> <li>• <b>Firmware Version:</b> Shows the firmware version of your projector.</li> </ul>
-------------------------------------	--

# Maintenance

## Care of the projector

### Cleaning the lens

Clean the lens whenever you notice dirt or dust on the surface. Please be sure to turn off the projector and let it cool down completely before cleaning the lens.

- Use a canister of compressed air to remove dust.
- If there is dirt or smears, use lens-cleaning paper or moisten a soft cloth with lens cleaner and gently wipe the lens surface.
- Never use any type of abrasive pad, alkaline/acid cleaner, scouring powder, or volatile solvent, such as alcohol, benzene, thinner or insecticide. Using such materials or maintaining prolonged contact with rubber or vinyl materials may result in damage to the projector surface and cabinet material.

### Cleaning the projector case

Before you clean the case, turn the projector off using the proper shutdown procedure as described in [Shutting down the projector on page 23](#) and unplug the power cord.

- To remove dirt or dust, wipe the case with a soft, lint-free cloth.
- To remove stubborn dirt or stains, moisten a soft cloth with water and a neutral pH detergent. Then wipe the case.



Never use wax, alcohol, benzene, thinner or other chemical detergents. These can damage the case.

### Storing the projector

If you need to store the projector for an extended time, please follow the instructions below:

- Make sure the temperature and humidity of the storage area are within the recommended range for the projector. Please refer to [Specifications on page 40](#) or consult your dealer about the range.
- Retract the adjuster feet.
- Remove the battery from the remote control.
- Pack the projector in its original packing or equivalent.

### Transporting the projector

It is recommended that you ship the projector with its original packing or equivalent.

## Lamp information

### Getting to know the lamp hour

When the projector is in operation, the duration (in hours) of lamp usage is automatically calculated by the built-in timer. The method of calculating the equivalent lamp hour is as follows:

Lamp Usage Time = (hours used in **Normal** mode) + (hours used in **Economic** mode) + (hours used in **SmartEco** mode)

Total (equivalent) lamp hour = 2.0 × (hours used in **Normal** mode) + 1.4 × (hours used in **Economic** mode) + 1.0 × (hours used in **SmartEco** mode)



To obtain the lamp hour information:

1. Go to **SYSTEM SETUP: ADVANCED > Lamp Settings** and press **OK**. The **Lamp Settings** page appears.
2. Press **▼** to select **Lamp Timer** and press **OK**. The **Lamp Timer** information is displayed.

You can also get the lamp hour information on the **INFORMATION** menu.

## Extending lamp life

### • Setting the **Light Mode**

Go to **PICTURE > Advanced > Light Mode** and press **◀/▶** or press **LIGHT MODE** on the remote control to select a suitable lamp power from among the provided modes.

Setting the projector in **Economic** or **SmartEco** mode extends lamp life.

Lamp mode	Description
<b>Normal</b>	Provides full lamp brightness
<b>Economic</b>	Lowers brightness to extend the lamp life and decreases the fan noise
<b>SmartEco</b>	Adjusts the lamp power automatically depending on the content brightness level

### • Setting **Auto Off**

This function allows the projector to turn off automatically if no input signal is detected after a set period of time to prevent unnecessary waste of lamp life.

To set **Auto Off**, go to **SYSTEM SETUP: BASIC > Auto Off** and press **◀/▶**.

## Timing of replacing the lamp

When the **Lamp indicator** lights up red or a message appears suggesting it is time to replace the lamp, please consult your dealer or go to <http://www.BenQ.com> before installing a new lamp. An old lamp may cause a malfunction in the projector and in some instances the lamp may explode.



- The apparent brightness of the projected image will vary depending on the ambient lighting conditions, selected input signal contrast/brightness settings, and is directly proportional to projection distance.
- The lamp brightness will decline over time and may vary within the lamp manufacturers specifications. This is normal and expected behavior.
- The **LAMP indicator light** and **TEMPERATURE warning light** will light up if the lamp becomes too hot. Turn the power off and let the projector cool for 45 minutes. If the Lamp or Temp indicator still lights up after turning the power back on, please contact your dealer. See [Indicators on page 37](#).

The following Lamp warning displays will remind you to change the lamp.

	<p>Install a new lamp for optimal performance. If the projector is normally run with <b>Economic</b> selected (See <a href="#">Getting to know the lamp hour on page 32</a>), you may continue to operate the projector until the next hour lamp warning appears. Press <b>OK</b> to dismiss the message.</p>
	<p>It is strongly recommended that you replace the lamp at this age. The lamp is a consumable item. The lamp brightness diminishes with use. This is normal lamp behavior. You can replace the lamp whenever you notice that the brightness level has significantly diminished. Press <b>OK</b> to dismiss the message.</p>

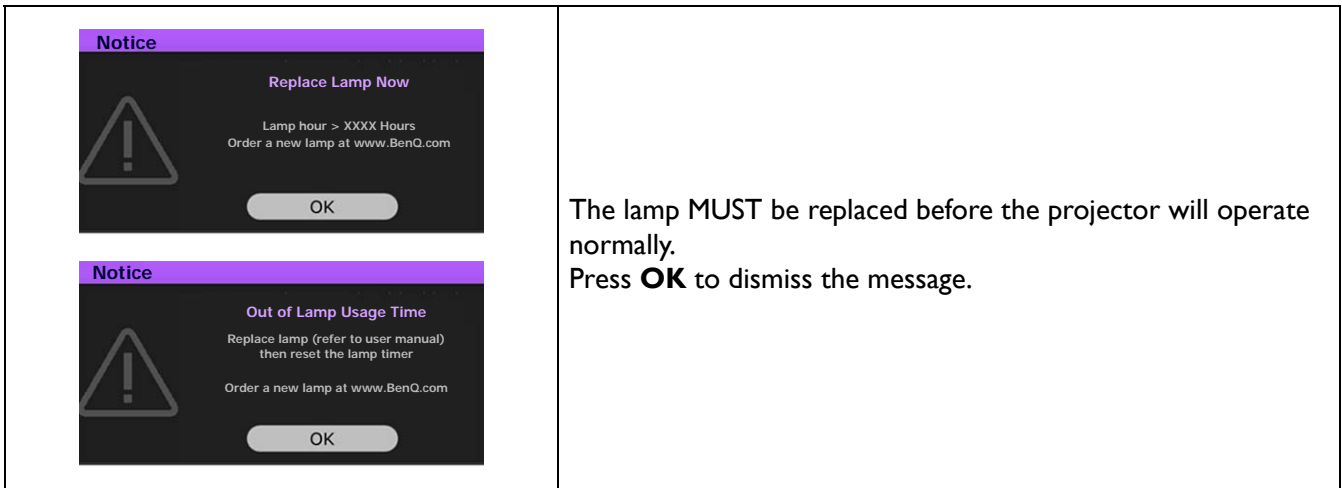

"XXXX" shown in the above messages are numbers that vary depending on different models.

## Replacing the lamp



- To reduce the risk of electrical shock, always turn the projector off and disconnect the power cord before changing the lamp.
- To reduce the risk of severe burns, allow the projector to cool for at least 45 minutes before replacing the lamp.
- To reduce the risk of injuries to fingers and damage to internal components, use caution when removing lamp glass that has shattered into sharp pieces.
- To reduce the risk of injuries to fingers and/or compromising image quality by touching the lens, do not touch the empty lamp compartment when the lamp is removed.
- This lamp contains mercury. Consult your local hazardous waste regulations to dispose of this lamp in a proper manner.
- To assure optimal performance from the projector, it is recommended that you purchase a qualified projector lamp for lamp replacement.
- If lamp replacement is performed while the projector is suspended upside-down from the ceiling, make sure that no one is underneath the lamp socket to avoid any possible injury or damage to the human eyes caused by fractured lamp.
- Ensure good ventilation when handling broken lamps. We recommend that you use respirators, safety glasses, goggles or face shield and wear protective clothing such as gloves.

1. Turn the power off and disconnect the projector from the power outlet. If the lamp is hot, avoid burns by waiting for approximately 45 minutes until the lamp has cooled.
2. Locate the arrow mark on the lamp cover. Press where the arrow mark is and push to slide the lamp cover in the direction of the arrow.

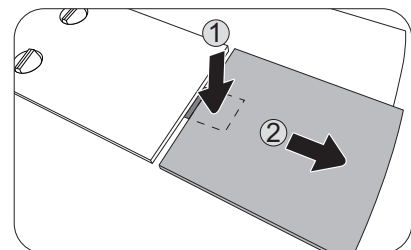

3. Open the lamp cover.



Do not turn the power on with the lamp cover open.

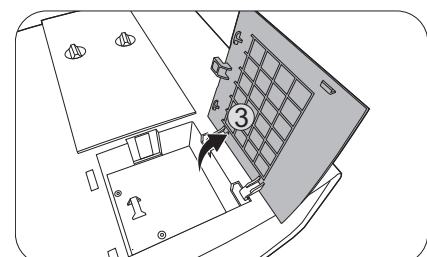

4. Loosen the screws that secure the inner lamp cover, and open it.
5. Loosen the screw that secures the lamp.
6. Lift the handle so that it stands up.

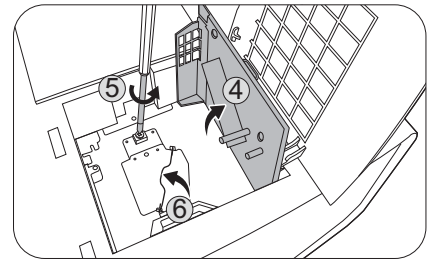

7. Use the handle to slowly pull the lamp out of the projector.



- Pulling it too quickly may cause the lamp to break and scatter broken glass in the projector.
- Do not place the lamp in locations where water might splash on it, children can reach it, or near flammable materials.
- Do not insert your hands into the projector after the lamp is removed. The sharp edges inside the projector may cause injuries. If you touch the optical components inside, it could cause color unevenness and distortion of the projected images.

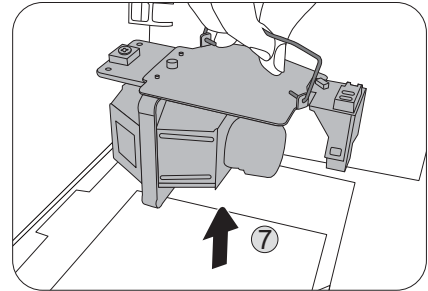

8. As shown in the figure, lower the new lamp.

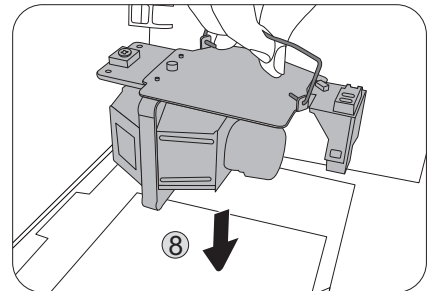

9. Tighten the screw that secures the lamp.
10. Ensure the handle is fully laid flat and locked in place.
11. Replace the inner lamp cover and tighten the screws.



- Loose screw may cause a bad connection, which could result in malfunction.
- Do not over tighten the screw.

12. Replace the lamp cover on the projector.
13. Slide it back into position.
14. Connect the power and restart the projector.

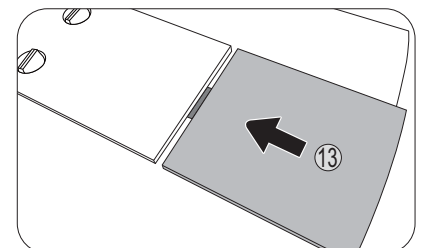
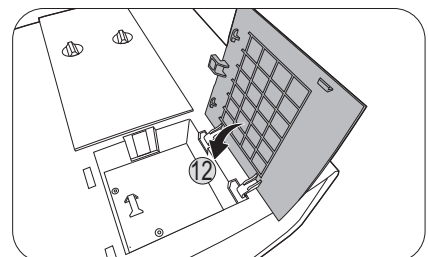
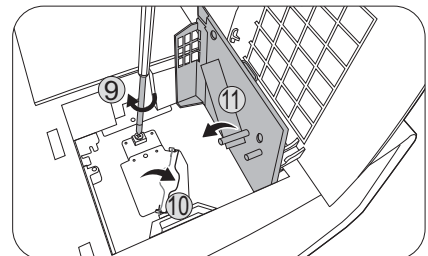

















































































## Resetting the lamp timer













15. After the startup logo, open the On-Screen Display (OSD) menu. Go to **SYSTEM SETUP: ADVANCED > Lamp Settings** and press **OK**. The **Lamp Settings** page appears. Highlight **Reset Lamp Timer** and press **OK**. A warning message is displayed asking if you want to reset the lamp timer. Highlight **Reset** and press **OK**. The lamp time will be reset to “0”.











Do not reset if the lamp is not new or replaced as this could cause damage.

## Indicators

Light			Status & Description
POWER 	TEMP 	LAMP 	
<b>Power events</b>			
			Stand-by mode
			Powering up
			Normal operation
			Normal power-down cooling
			Download
			CW start fail
			Scaler shutdown fail (data abort)
			Scaler reset fail (video projector only)
			LAN download fail
			LAN download processing
			Burn-in ON
			Burn-in OFF
<b>Lamp events</b>			
			Lamp I error in normal operation
			Lamp is not lit up
<b>Thermal events</b>			
			Fan 1 error (the actual fan speed is $\pm 25\%$ outside the desired speed)
			Fan 2 error (the actual fan speed is $\pm 25\%$ outside the desired speed)
			Fan 3 error (the actual fan speed is $\pm 25\%$ outside the desired speed)
			Fan 4 error (the actual fan speed is $\pm 25\%$ outside the desired speed)
			Fan 5 error (the actual fan speed is $\pm 25\%$ outside the desired speed)
			Fan 6 error (the actual fan speed is $\pm 25\%$ outside the desired speed)
			Fan 7 error (the actual fan speed is $\pm 25\%$ outside the desired speed)
			Fan 8 error (the actual fan speed is $\pm 25\%$ outside the desired speed)
			Temperature I error (over limited temperature)
			Thermal sensor I open error
			Thermal sensor I short error
			Thermal IC#I I2C connection error

			Temperature 2 error (over limited temperature)
			Thermal Sensor 2 open error
			Thermal Sensor 2 short error
			Thermal IC #2 I2C connection error

	 : <b>Off</b>	 : Orange On	 : Green On	 : Red On
		 : Orange Flashing	 : Green Flashing	 : Red Flashing

# Troubleshooting

## ? The projector does not turn on.

Cause	Remedy
There is no power from the power cord.	Plug the power cord into the AC power jack on the projector, and plug the power cord into the power outlet. If the power outlet has a switch, make sure that it is switched on.
Attempting to turn the projector on again during the cooling process.	Wait until the cooling down process has completed.

## ? No picture

Cause	Remedy
The video source is not turned on or connected correctly.	Turn the video source on and check that the signal cable is connected correctly.
The projector is not correctly connected to the input signal device.	Check the connection.
The input signal has not been correctly selected.	Select the correct input signal with the <b>SOURCE</b> key.
The lens cover is still closed.	Open the lens cover.

## ? Blurred image

Cause	Remedy
The projection lens is not correctly focused.	Adjust the focus of the lens using the focus ring.
The projector and the screen are not aligned properly.	Adjust the projection angle and direction as well as the height of the projector if necessary.
The lens cover is still closed.	Open the lens cover.

## ? Remote control does not work.

Cause	Remedy
The batteries are out of power.	Replace both of the batteries with new ones.
There is an obstacle between the remote control and the projector.	Remove the obstacle.
You are too far away from the projector.	Stand within 8 meters (26 feet) of the projector.

## ? The password is incorrect.

Cause	Remedy
You do not remember the password.	See <a href="#">Entering the password recall procedure on page 21</a> .

# Specifications

## Projector specifications



All specifications are subject to change without notice.

### Optical

#### Resolution

3840 x 2160 with XPR  
2716 x 1528 without XPR

#### Display system

1-CHIP DMD

#### Lens

F = 2.05 to 2.37, f = 20.54 to 30.31 mm

#### Clear focus range

2.85–5.4 m @ Wide,  
4.28–8.1 m @ Tele

#### Lamp

240 W lamp

### Electrical

#### Power supply

AC100–240V, 3.9 A, 50–60 Hz (Automatic)

#### Power consumption

384 W (Max); < 0.5 W (Standby)

### Mechanical

#### Weight

14.8 Kg (32.6 lbs)

### Output terminals

12V DC x 2

### Control

#### RS-232 serial control

9 pin x 1

IR receiver x 2

### Input terminals

#### Computer input

RGB input

D-Sub 15-pin (female) x 1

#### Video signal input

Digital

HDMI (1.4a, HDCP 1.1) x 1;

HDMI (2.0, HDCP 2.2) x 1

USB port (Mini-B x 1)

### Environmental Requirements

#### Operating temperature

0°C–40°C at sea level

#### Storage temperature

-20°C–60°C at sea level

#### Operating/Storage relative humidity

10%–90% (without condensation)

#### Operating altitude

0–1499 m at 0°C–35°C

1500–3000 m at 0°C–30°C (with

High Altitude Mode on)

## Dimensions

470.7 mm (W) x 224.9 mm (H) x 564.7 mm (D)

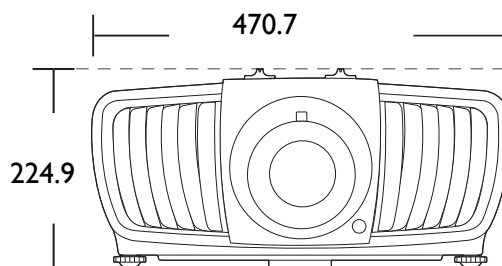
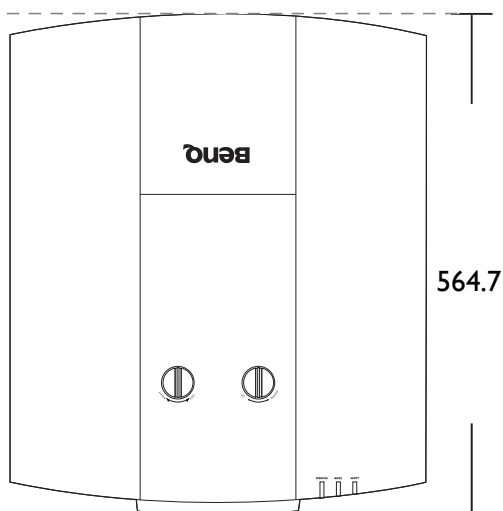

Unit: mm



# Timing chart

## Supported timing for PC input

Resolution	Mode	Vertical Frequency (Hz)	Horizontal Frequency (kHz)	Pixel Frequency (MHz)
720 x 400	720x400_70	70.087	31.469	28.3221
640 x 480	VGA_60	59.940	31.469	25.175
	VGA_72	72.809	37.861	31.500
	VGA_75	75.000	37.500	31.500
	VGA_85	85.008	43.269	36.000
800 x 600	SVGA_60	60.317	37.879	40.000
	SVGA_72	72.188	48.077	50.000
	SVGA_75	75.000	46.875	49.500
	SVGA_85	85.061	53.674	56.250
	SVGA_120 (Reduce Blanking)	119.854	77.425	83.000
1024 x 768	XGA_60	60.004	48.363	65.000
	XGA_70	70.069	56.476	75.000
	XGA_75	75.029	60.023	78.750
	XGA_85	84.997	68.667	94.500
	XGA_120 (Reduce Blanking)	119.989	97.551	115.500
1152 x 864	1152 x 864_75	75.00	67.500	108.000
1024 x 576	BenQ NB Timing	60.0	35.820	46.966
1024 x 600	BenQ NB Timing	64.995	41.467	51.419
1280 x 720	1280 x 720_60	60	45.000	74.250
1280 x 768	1280 x 768_60	59.870	47.776	79.5
1280 x 800	WXGA_60	59.810	49.702	83.500
	WXGA_75	74.934	62.795	106.500
	WXGA_85	84.880	71.554	122.500
	WXGA_120 (Reduce Blanking)	119.909	101.563	146.25
1280 x 1024	SXGA_60	60.020	63.981	108.000
	SXGA_75	75.025	79.976	135.000
	SXGA_85	85.024	91.146	157.500
1280 x 960	1280 x 960_60	60.000	60.000	108
	1280 x 960_85	85.002	85.938	148.500
1360 x 768	1360 x 768_60	60.015	47.712	85.500
1440 x 900	WXGA+_60	59.887	55.935	106.500
1400 x 1050	SXGA+_60	59.978	65.317	121.750
1600 x 1200	UXGA	60.000	75.000	162.000
1680 x 1050	1680x1050_60	59.954	65.290	146.250
640 x 480@67Hz	MAC13	66.667	35.000	30.240
832 x 624@75Hz	MAC16	74.546	49.722	57.280
1024 x 768@75Hz	MAC19	74.93	60.241	80.000
1152 x 870@75Hz	MAC21	75.06	68.68	100.00



The timings showing above may not be supported due to EDID file and VGA graphic card limitations. It is possible that some timings cannot be chosen.

## Supported timing for HDMI (HDCP) input

- PC timings

Resolution	Mode	Vertical Frequency (Hz)	Horizontal Frequency (kHz)	Pixel Frequency (MHz)
640 x 480	VGA_60	59.940	31.469	25.175
	VGA_72	72.809	37.861	31.500
	VGA_75	75.000	37.500	31.500
	VGA_85	85.008	43.269	36.000
720 x 400	720 x 400_70	70.087	31.469	28.322
800 x 600	SVGA_60	60.317	37.879	40.000
	SVGA_72	72.188	48.077	50.000
	SVGA_75	75.000	46.875	49.500
	SVGA_85	85.061	53.674	56.250
	SVGA_120 (Reduce Blanking)	119.854	77.425	83.000
1024 x 768	XGA_60	60.004	48.363	65.000
	XGA_70	70.069	56.476	75.000
	XGA_75	75.029	60.023	78.750
	XGA_85	84.997	68.667	94.500
	XGA_120 (Reduce Blanking)	119.989	97.551	115.500
1152 x 864	1152 x 864_75	75.00	67.500	108.000
1024 x 576	BenQ Notebook Timing	60.00	35.820	46.996
1024 x 600	BenQ Notebook Timing	64.995	41.467	51.419
1280 x 720	1280 x 720_60	60	45.000	74.250
1280 x 768	1280 x 768_60	59.870	47.776	79.5
1280 x 800	WXGA_60	59.810	49.702	83.500
	WXGA_75	74.934	62.795	106.500
	WXGA_85	84.880	71.554	122.500
	WXGA_120 (Reduce Blanking)	119.909	101.563	146.25
1280 x 1024	SXGA_60	60.020	63.981	108.000
	SXGA_75	75.025	79.976	135.000
	SXGA_85	85.024	91.146	157.500
1280 x 960	1280 x 960_60	60.000	60.000	108
	1280 x 960_85	85.002	85.938	148.500
1360 x 768	1360 x 768_60	60.015	47.712	85.500
1440 x 900	WXGA+_60	59.887	55.935	106.500
1400 x 1050	SXGA+_60	59.978	65.317	121.750
1600 x 1200	UXGA	60.000	75.000	162.000
1680 x 1050	1680 x 1050_60	59.954	65.290	146.250
640 x 480@67Hz	MAC13	66.667	35.000	30.240
832 x 624@75Hz	MAC16	74.546	49.722	57.280
1024 x 768@75Hz	MAC19	75.020	60.241	80.000
1152 x 870@75Hz	MAC21	75.06	68.68	100.00
1920 x 1080@60HZ	1920X1080_60 (Reduce Blanking)	60	67.5	148.5
1920 x 1200@60HZ	1920X1200_60 (Reduce Blanking)	59.95	74.038	154



The timings showing above may not be supported due to EDID file and VGA graphic card limitations. It is possible that some timings cannot be chosen.

- Video timings

Timing	Resolution	Vertical Frequency (Hz)	Horizontal Frequency (kHz)	Pixel Frequency (MHz)
480i	720(1440) x 480	59.94	15.73	27
480p	720 x 480	59.94	31.47	27
576i	720(1440) x 576	50	15.63	27
576p	720 x 576	50	31.25	27
720/50p	1280 x 720	50	37.5	74.25
720/60p	1280 x 720	60	45.00	74.25
1080/24P	1920 x 1080	24	27	74.25
1080/25P	1920 x 1080	25	28.13	74.25
1080/30P	1920 x 1080	30	33.75	74.25
1080/50i	1920 x 1080	50	28.13	74.25
1080/60i	1920 x 1080	60	33.75	74.25
1080/50P	1920 x 1080	50	56.25	148.5
1080/60P	1920 x 1080	60	67.5	148.5
2160/24P	3840 x 2160	24	54	297
2160/25P	3840 x 2160	25	56.25	297
2160/30P	3840 x 2160	30	67.5	297
2160/50P	3840 x 2160	50	112.5	594
2160/60P	3840 x 2160	60	135	594