



HT2150ST  
Digital Projector  
Home Cinema Series  
User Manual

# Table of contents

Important safety instructions.....	3	connected.....	26
Overview.....	6	Basic OSD menu - without input signals connected.....	29
Projector features .....	6	Using the Advanced OSD menu.....	30
Shipping contents.....	7	<b>Picture</b> menu.....	31
Standard accessories.....	7	<b>Audio Setup</b> menu.....	35
Optional accessories.....	7	<b>Display</b> menu.....	36
Projector exterior view .....	8	<b>System Setup : Basic</b> menu.....	38
Controls and functions.....	9	<b>System Setup : Advanced</b> menu.....	39
Control panel .....	9	<b>Information</b> menu.....	41
Remote control.....	10	<b>Advanced OSD</b> menu structure .....	42
Installation .....	12	Maintenance .....	44
Choosing a location .....	12	Care of the projector .....	44
Obtaining a preferred projected image size .....	13	Lamp information.....	45
Projection dimensions .....	13	Getting to know the lamp hour.....	45
Connection .....	14	Extending lamp life .....	45
Connecting with video equipment .....	14	Timing of replacing the lamp .....	46
Connecting HDMI devices.....	14	Replacing the lamp .....	47
Connecting smart devices .....	14	Indicators .....	49
Connecting a computer .....	15	Troubleshooting.....	51
Operation.....	16	Specifications.....	52
Starting up the projector .....	16	Projector specifications.....	52
Shutting down the projector .....	18	Dimensions .....	53
Securing the projector .....	18	Ceiling mount installation.....	53
Using a security cable lock .....	18	Timing chart.....	54
Utilizing the password function.....	18	Warranty and Copyright information .....	59
Selecting an input source.....	21	Warranty .....	59
Renaming an input source .....	21	Copyright.....	59
Adjusting the projected image.....	22	Disclaimer .....	59
Adjusting the projection angle.....	22		
Auto-adjusting the image .....	22		
Fine-tuning the image size and clarity . .	22		
Correcting keystone .....	23		
Menu Functions.....	24		
About the OSD Menus .....	24		
Using the <b>Basic</b> OSD menu .....	26		
Basic OSD menu - with input signals			

# Important safety instructions

Your projector is designed and tested to meet the latest standards for safety of information technology equipment. However, to ensure safe use of this product, it is important that you follow the instructions mentioned in this manual and marked on the product.

1. Please read this user manual before you operate your projector. Keep this manual in a safe place for future reference.

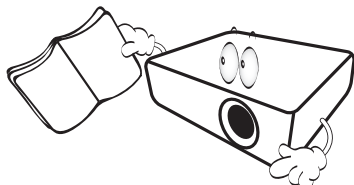

2. Always place the projector on a level, horizontal surface during operation.

- Do not place the projector on an unstable cart, stand, or table as it may fall and be damaged.
- Do not place inflammables near the projector.
- Do not use if tilted at an angle of more than 10 degrees left to right, nor at angle of more than 15 degrees front to back.

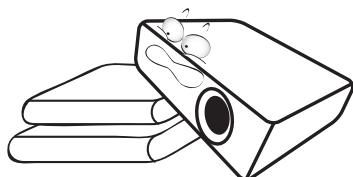

3. Do not store the projector on end vertically. Doing so may cause the projector to fall over, causing injury or resulting in damage.

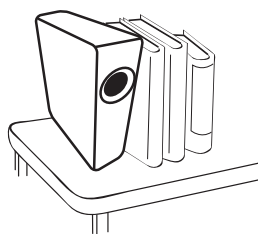

4. Do not place the projector in any of the following environments:

- Space that is poorly ventilated or confined. Allow at least 50 cm clearance from walls and free flow of air around the projector.
- Locations where temperatures may become excessively high, such as the inside of a car with all windows closed.
- Locations where excessive humidity, dust, or cigarette smoke may contaminate optical components, shorten the projector's lifespan and darken the screen.

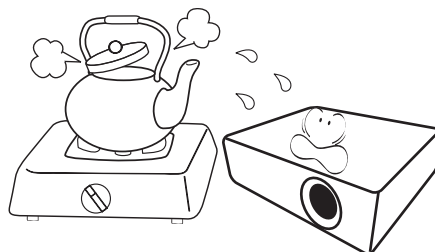

- Locations near fire alarms.
- Locations with an ambient temperature above 35°C/95°F.
- Locations where the altitudes are higher than 3000 m (10000 feet).

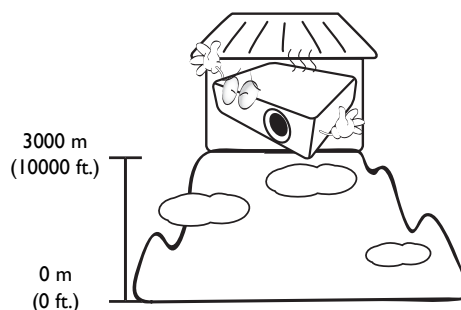

5. Do not block the vents while the projector is on (even in standby mode).
  - Do not cover the projector with any item.
  - Do not place the projector on a blanket, bedding or any other soft surface.

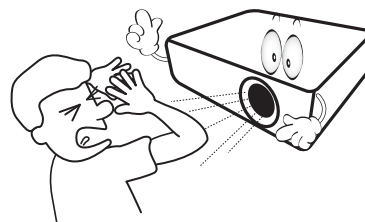
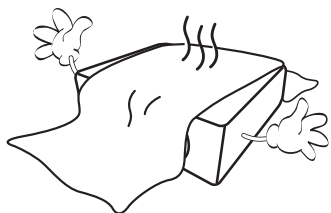

6. In areas where the mains power supply voltage may fluctuate by  $\pm 10$  volts, it is recommended that you connect the projector through a power stabilizer, surge protector or uninterruptible power supply (UPS) as appropriate to your situation.

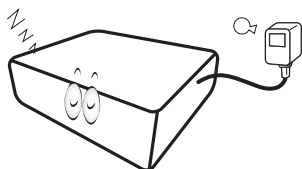

10. Do not operate the projector lamp beyond the rated lamp life. Excessive operation of lamps beyond the rated life could cause a lamp to break on rare occasions.

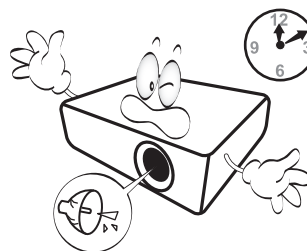

7. Do not step on the projector or place any objects upon it.

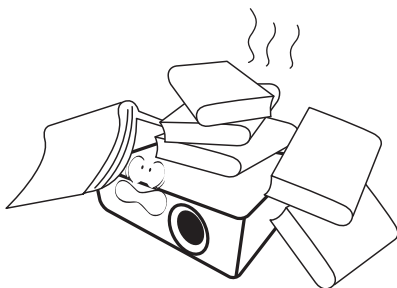

11. The lamp becomes extremely hot during operation. Allow the projector to cool for approximately 45 minutes prior to removing the lamp assembly for replacement.

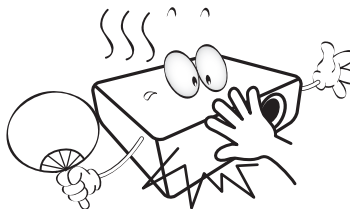

8. Do not place liquids near or on the projector. Liquids spilled into the projector will void your warranty. If the projector does become wet, disconnect it from the power outlet and contact BenQ to have the projector repaired.

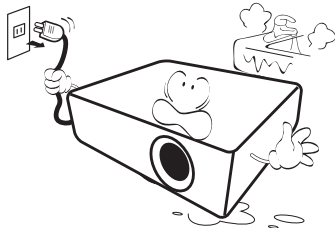

12. Never attempt to replace the lamp assembly until the projector has cooled down and is unplugged from the power supply.

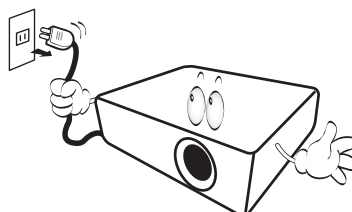

13. This projector is capable of displaying inverted images for ceiling mount installation. Use only BenQ's Ceiling Mount Kit for mounting.

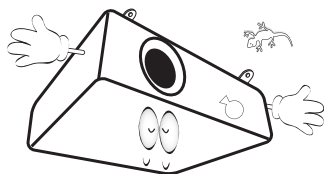

15. When you think service or repair is required, take the projector only to a suitably qualified technician.

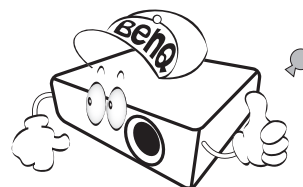

### ⚠ Ceiling mounting the projector

**If you intend to mount your projector on the ceiling, we strongly recommend that you use a proper fitting BenQ projector ceiling mount kit and ensure it is securely and safely installed.**

**If you use a non-BenQ brand projector ceiling mount kit, there is a safety risk that the projector may fall from the ceiling due to an improper attachment through the use of the wrong gauge or length screws.**

**You can purchase a BenQ projector ceiling mount kit from the place you purchased your BenQ projector. BenQ recommends that you also purchase a separate Kensington lock compatible security cable and attach it securely to both the Kensington lock slot on the projector and the base of the ceiling mount bracket. This will perform the secondary role of restraining the projector should its attachment to the mounting bracket become loose.**

14. Do not attempt to disassemble this projector. There are dangerous high voltages inside which may cause death if you should come into contact with live parts. The only user serviceable part is the lamp. See page 47.

Under no circumstances should you ever undo or remove any other covers. Refer servicing only to suitably qualified professional service personnel.

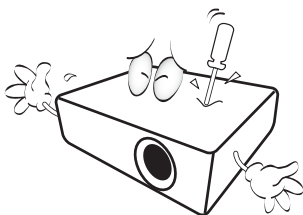

- ⚠ **Please keep the original packing for possible future shipment. If you need to pack your projector after use, adjust the projection lens to an appropriate position, put the lens cushion around the lens, and fit the lens cushion and projector cushion together to prevent damage during transportation.**

### Moisture condensation

Never operate the projector immediately after moving it from a cold location to a hot location. When the projector is exposed to such a change in temperature, moisture may condense on the crucial internal parts. To prevent the projector from possible damage, do not use the projector for at least 2 hours when there is a sudden change in temperature.

### Avoid volatile liquids

Do not use volatile liquids, such as insecticide or certain types of cleaner, near the projector. Do not have rubber or plastic products touching the projector for a long time. They will leave marks on the finish. If cleaning with a chemically treated cloth, be sure to follow the cleaning product's safety instructions.

### Disposal

This product contains the following materials which are harmful to human bodies and environment.

- Lead, which is contained in solder.
- Mercury, which is used in the lamp.

To dispose of the product or used lamps, consult your local environment authorities for regulations.

# Overview

## Projector features

- **Full HD compatible**  
The projector is compatible with Standard Definition TV (SDTV) 480i, 576i, Enhanced Definition television (EDTV) 480p, 576p and High Definition TV (HDTV) 720p, 1080i/p 60Hz formats, with the 1080p format providing a true 1:1 image reproduction.
- **High picture quality**  
The projector provides excellent picture quality due to its high resolution, excellent home theater brightness, high contrast ratio, vivid color and rich gray-scale reproduction.
- **High brightness**  
The projector features super high brightness to achieve excellent picture quality in ambient light conditions, outperforming ordinary projectors.
- **Vivid color reproduction**  
The projector features a 6-segment color wheel to produce realistic color depth and range unattainable with lesser segment color wheels.
- **Rich gray-scale**  
When viewed in a dark environment, the automatic gamma control provides excellent gray-scale display which reveals details in shadows and in night or dark scenes.
- **Dual OSD**  
Two types of OSD menus are designed for different usage scenarios: the **Basic** OSD is intuitive and easy, while the **Advanced** OSD offers full range of advanced adjustments.
- **Wide variety of inputs and video formats**  
The projector supports a wide variety of inputs for connection to your video and computer equipment, including personal computer (both Mac and PC), HDMI source, and an output trigger for connection to automated screen and environment lighting systems.
- **ISF certified calibration control**  
To reach a higher standard of performance, the projector incorporates ISF NIGHT and ISF DAY mode settings in its OSD menus, which requires professional calibration service from authorized ISF installers.
- **3D function**  
To enjoy the 3D movies, videos, and sporting events in a more realistic way by presenting the depth of the images through HDMI.
- **Built-in chamber speakers with audio enhancer**  
Built-in speakers providing mixed mono audio when an audio input is connected.
- **SmartEco**  
SmartEco™ technology saves lamp power consumption up to 70% depending on the content brightness level when **SmartEco** mode is selected.

# Shipping contents

Carefully unpack and verify that you have the items below. Some of the items may not be available depending on your region of purchase. Please check with your place of purchase.

## Standard accessories

Some of the accessories may vary from region to region.

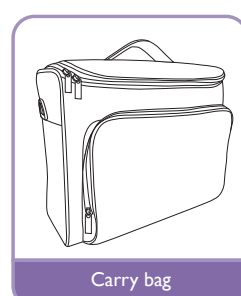
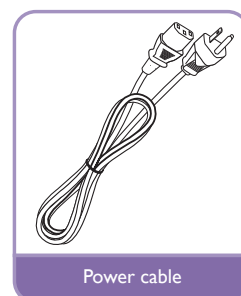
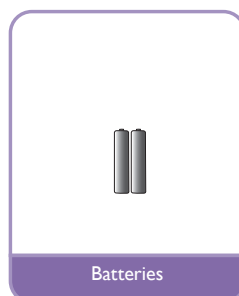
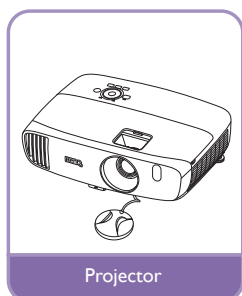

\* The warranty card is only supplied in some specific regions. Please consult your dealer for detailed information.

## Optional accessories

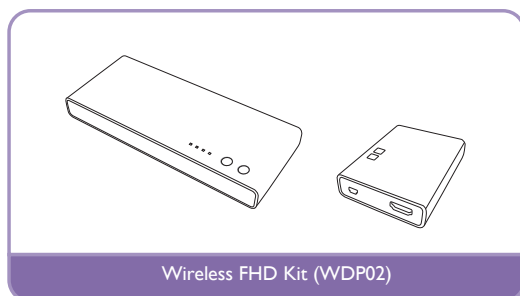



# Projector exterior view

## Front and upper side view

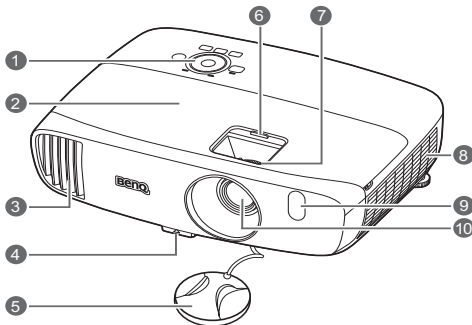

## Rear and lower side view

See [Connecting with video equipment](#) for connection details.

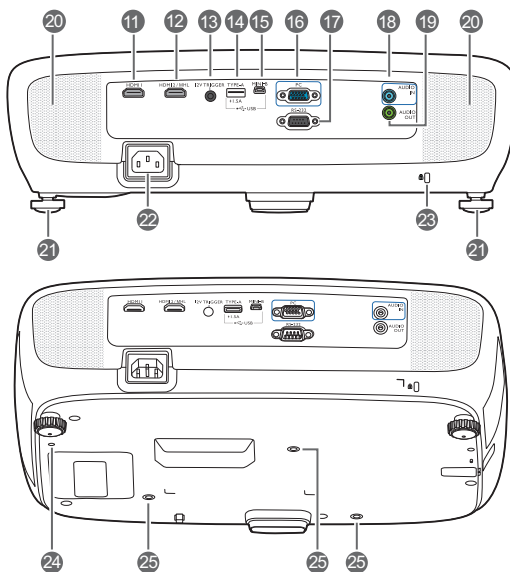

**1. Control panel** (See [Control panel](#) for details.)

**2. Lamp cover**

**3. Vent (heated air exhaust)**

**4. Quick-release button**

**5. Lens cap**

**6. Lens compartment cover**

**7. Focus and Zoom rings**

**8. Vent (cool air intake)**

**9. Front IR sensor**

**10. Projection lens**

**11. HDMI input port**

**12. MHL/HDMI dual mode port**

Connects to MHL or HDMI compatible devices and charges the connected MHL compatible device as long as power is fed to the projector.

**13. 12VDC output terminal**

Triggers external devices such as an electric screen or light control, etc.

**14. USB Type-A port**

Charges the receiver box of the Wireless FHD Kit (optional accessory).

**15. USB Mini-B port**

Used for service.

**16. RGB (PC)/Component video (YPbPr/YCbCr) signal input jack**

**17. RS-232 control port**

Interfaces with a PC or home theater control/automation system.

**18. Audio input jack**

**19. Audio output jack**

**20. Speaker grills**

**21. Rear adjuster feet**

**22. AC Power cable inlet**

**23. Kensington lock slot**

**24. Wireless FHD Kit mount hole (WDP02)**

**25. Ceiling mount holes**



# Controls and functions

## Control panel

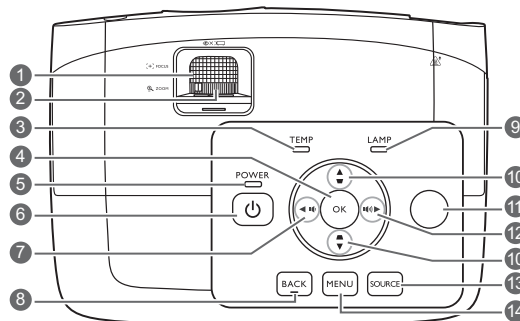

### 1. Focus ring

Adjusts the focus of the projected image.

### 2. Zoom ring

Adjusts the size of the image.

### 3. TEMPERATURE warning light

Lights up red if the projector's temperature becomes too high.

### 4. OK

Confirms the selected On-Screen Display (OSD) menu item.

### 5. POWER indicator light

Lights up or flashes when the projector is under operation.

### 6. POWER

Toggles the projector between standby mode and on.

### 7. Left /

- Decreases the projector audio volume.
- When the **Keystone** window is displayed, manually corrects distorted images resulting from an angled projection.
- When the On-Screen Display (OSD) menu is activated, the #7, #10, and #12 keys are used as directional arrows to select the desired menu items and to make adjustments.

### 8. BACK

Goes back to the previous OSD menu, exits and saves menu settings.

### 9. LAMP indicator light

Indicates the status of the lamp. Lights up or flashes when the lamp has developed a problem.

### 10. Keystone/Arrow keys ( / , / )

Manually corrects distorted images resulting from an angled projection.

When the On-Screen Display (OSD) menu is activated, the #7, #10, and #12 keys are used as directional arrows to select the desired menu items and to make adjustments.

### 11. Top IR remote sensor

### 12. Right /

- Increases the projector audio volume.
- When the **Keystone** window is displayed, manually corrects distorted images resulting from an angled projection.
- When the On-Screen Display (OSD) menu is activated, the #7, #10, and #12 keys are used as directional arrows to select the desired menu items and to make adjustments.

### 13. SOURCE

Displays the source selection bar.

### 14. MENU

- Accesses the On-Screen Display (OSD) menu.
- Exits and saves menu settings.

# Remote control

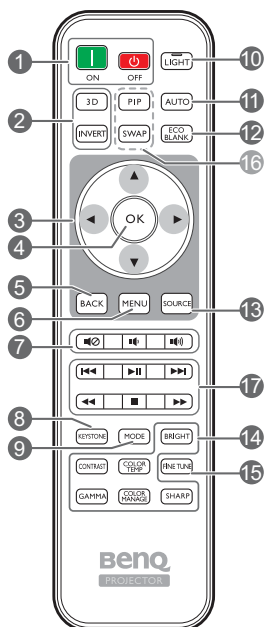

## 1. ON, OFF

Toggles the projector between on and off modes.

## 2. 3D, INVERT

Launches the **3D** menu and toggles the invert function between on and off.

## 3. Arrow keys (◀ Left, ▶ Right, ▲ Up, ▼ Down)

When the On-Screen Display (OSD) menu is activated, these keys are used as directional arrows to select the desired menu items and to make adjustments.

## 4. OK

Confirms the selected OSD menu item.

## 5. BACK

Goes back to the previous OSD menu, exits and saves menu settings.

## 6. MENU

- Accesses the On-Screen Display (OSD) menu.
- Exits and saves menu settings.

## 7. Volume keys

- : Toggles projector audio between on and off.
- : Decreases the projector audio volume.
- : Increases the projector audio volume.

## 8. KEYSTONE

Launches the **Keystone** window. Use ▲ or ▼ to manually correct distorted images resulting from an angled projection.

## 9. MODE

Selects an available picture mode.

## 10. LIGHT

The LED backlight lights up and stays on for approximately 10 seconds when pressing any key on the remote control. Pressing any other keys within 10 second again turns the LED backlight off.

## 11. AUTO

Automatically determines the best picture timings for the displayed image.

## 12. ECO BLANK

Used to blank the screen picture.

## 13. SOURCE

Displays the source selection bar.

## 14. Picture quality adjustment keys

These function keys perform the same tasks as specified in the OSD menu.

## 15. FINE TUNE

Displays the **Color Temperature Fine Tuning** window. See [Color Temperature Fine Tuning](#) for details.

## 16. Unavailable keys

These keys are not available: **PIP** and **SWAP**.

## 17. HDMI CEC-compatible device control keys

(◀◀ Backward, ▶▶ Play, ▶▶ Forward, ◀◀ Rewind, ■ Stop, ▶▶ Fast forward)

Goes to the previous file/Plays/Goes to the next file/Rewinds/Stops/Fast-forwards during media playback. Only available when controlling your HDMI CEC-compatible devices.

The ▶▶ key does not pause the video.

## Installing/replacing the remote control batteries

1. Press and slide open the battery cover as illustrated.
2. Remove the old batteries (if applicable) and install two AAA batteries. Make sure that the positive and negative ends are positioned correctly as illustrated.
3. Slide the battery cover back until it clicks into place.

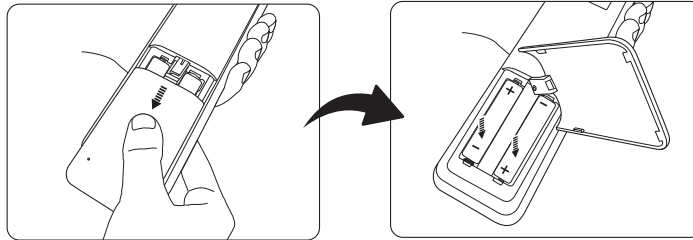

- ⚠ • **Avoid leaving the remote control and batteries in an excessive heat or humid environment like the kitchen, bathroom, sauna, sunroom or in a closed car.**
- **Replace only with the same or equivalent type recommended by the battery manufacturer.**
- **Dispose of the used batteries according to the manufacturer's instructions and local environment regulations for your region.**
- **Never throw the batteries into a fire. There may be danger of an explosion.**
- **If the batteries are drained or if you will not be using the remote control for an extended period of time, remove the batteries to avoid damage to the remote control from possible battery leakage.**

## Remote control effective range

The remote control must be held at an angle within 30 degrees perpendicular to the projector's IR remote control sensor(s) to function correctly. The distance between the remote control and the sensor(s) should not exceed 8 meters (~ 26 feet).

Make sure that there are no obstacles between the remote control and the IR sensor(s) on the projector.

- **Operating the projector from the front**
- **Operating the projector from the top**

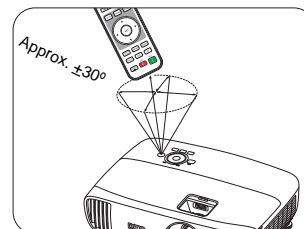
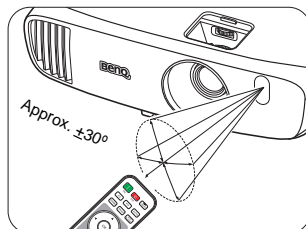



# Installation

## Choosing a location

Before choosing an installation location for your projector, take the following factors into consideration:

- Size and position of your screen
- Electrical outlet location
- Location and distance between the projector and the rest of your equipment

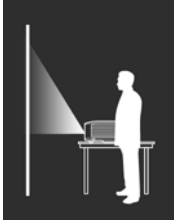
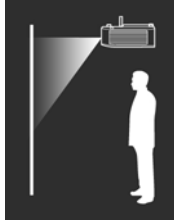
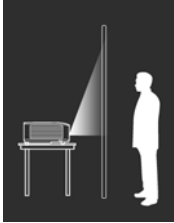
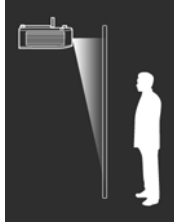
You can install your projector in the following ways.

<p><b>1. Front:</b></p> <p>Select this location with the projector placed near the floor in front of the screen.</p> <p>This is the most common way to position the projector for quick setup and portability.</p> <p>Turn on the projector and make the following settings:</p> <p><b>MENU &gt; Settings or System Setup : Basic &gt; Projector Position &gt; Front</b></p>		<p><b>3. Front Ceiling:</b></p> <p>Select this location with the projector suspended from the ceiling in front of the screen.</p> <p>Turn on the projector and make the following settings:</p> <p><b>MENU &gt; Settings or System Setup : Basic &gt; Projector Position &gt; Front Ceiling</b></p>		
<p><b>2. Rear:</b></p> <p>Select this location with the projector placed near the floor behind the screen.</p> <p>Turn on the projector and make the following settings:</p> <p><b>MENU &gt; Settings or System Setup : Basic &gt; Projector Position &gt; Rear</b></p>			<p><b>4. Rear Ceiling:</b></p> <p>Select this location with the projector suspended from the ceiling behind the screen.</p> <p>Turn on the projector and make the following settings:</p> <p><b>MENU &gt; Settings or System Setup : Basic &gt; Projector Position &gt; Rear Ceiling</b></p>	
<p> <b>A special rear projection screen is required.</b></p>		<p> <b>A special rear projection screen and the BenQ Projector Ceiling Mount Kit are required.</b></p>		

# Obtaining a preferred projected image size

The projected image size is determined by the distance from the projector lens to the screen, the zoom setting, and the video format.

## Projection dimensions

Use the illustration and the table below to help you determine the projection distance.

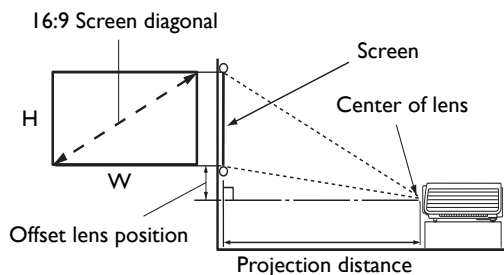

- The screen aspect ratio is 16:9 and the projected picture is in 16:9 aspect ratio

Screen size			Projection distance (mm)			Offset lens position (mm)	
Diagonal		H (mm)	W (mm)	Min. distance	Average		Max. distance
Inch	mm			(max. zoom)			(min. zoom)
60	1524	747	1328	917	1009	1102	19
70	1778	872	1550	1069	1178	1286	22
80	2032	996	1771	1222	1346	1470	25
90	2286	1121	1992	1375	1514	1654	28
100	2540	1245	2214	1528	1682	1837	31
110	2794	1370	2435	1680	1851	2021	34
120	3048	1494	2657	1833	2019	2205	37
140	3556	1743	3099	2139	2355	2572	44
160	4064	1992	3542	2444	2692	2940	50
180	4572	2241	3985	2750	3028	3307	56

All measurements are approximate and may vary from the actual sizes. If you want a permanent installation of the projector, we recommend that you use the actual projector to physically test the projection size, distance, and the projector's optical characteristics prior to the installation. This helps you determine the exact mounting position which best suits your installation.

# Connection

When connecting a signal source to the projector, be sure to:

1. Turn all equipment off before making any connections.
2. Use the correct signal cables for each source.
3. Make sure the cables are firmly inserted.

In the connection illustrations shown below, some cables may not be included with the projector (see [Shipping contents](#)). They are commercially available from electronics stores.

## Connecting with video equipment

You need only connect the projector to a video source device using just one of the connecting methods. Each video source provides different picture quality. The method you choose most likely depends upon the availability of matching terminals on both the projector and the video source device as described below:

Terminal name	Terminal appearance	Reference	Picture quality
<b>HDMI I HDMI2/MHL</b>		<ul style="list-style-type: none"> <li>• <a href="#">Connecting HDMI devices</a></li> <li>• <a href="#">Connecting smart devices</a></li> </ul>	Best
<b>PC (D-SUB)</b>		<a href="#">Connecting a computer</a>	Better

In the connection illustrations shown below, some cables may not be included with the projector (see [Shipping contents](#)). They are commercially available from electronics stores.

## Connecting HDMI devices

HDMI (High-Definition Multimedia Interface) supports uncompressed video data transmission between compatible devices like DTV tuners, DVD players, Blu-ray players and displays over a single cable. You should use an HDMI cable when making a connection between the projector and HDMI devices.

HDMI device: DVD player, digital tuner, etc.

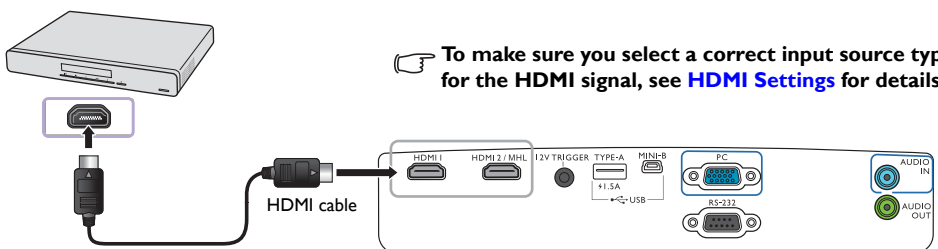

## Connecting smart devices

The projector can display contents directly from an MHL compatible smart device. Using an HDMI to Micro USB cable or HDMI to Micro USB adaptor, you can connect your smart devices to the projector and then enjoy your contents on the big screen.

Some smart devices may not be compatible to the cable that you use. Please consult the manufacturer of your smart device for detailed information.

- **Using an HDMI to Micro USB cable**

1. Connect one end of the HDMI to Micro USB cable to the HDMI input connector on the projector.
2. Connect the other end of the HDMI to Micro USB cable to the Micro USB output socket on your smart device.

- **Using an HDMI to Micro USB adaptor and an HDMI cable**

1. Connect one end of the HDMI cable to the HDMI input connector on the projector.
2. Connect the other end of the HDMI cable to the HDMI input socket on the adaptor.
3. Connect the other end of the adaptor to the Micro USB output socket on your smart device.

After connections, switch to the **HDMI2/MHL** input source. To switch input signal, see [Selecting an input source](#) for details.

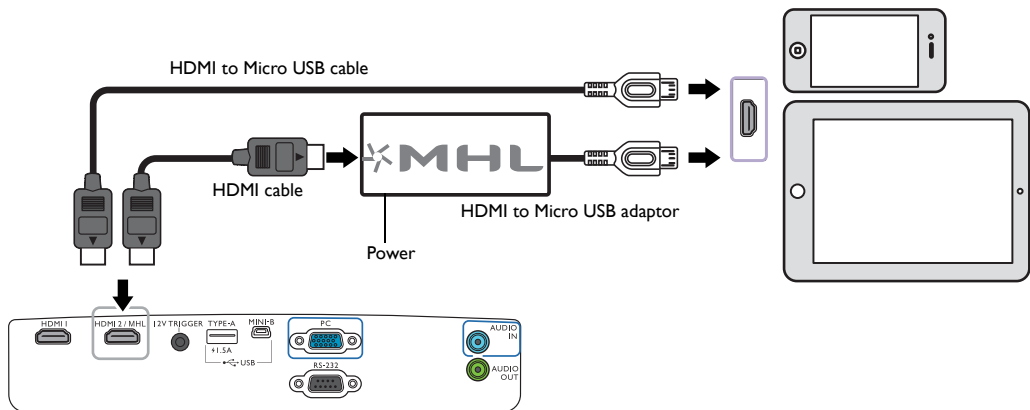

## Connecting a computer

Connect the projector to a computer with a VGA cable.

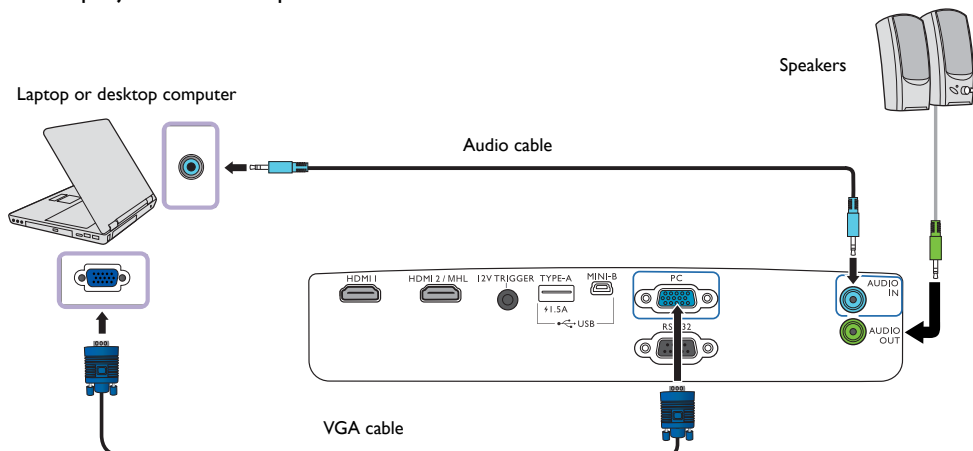

**Many laptops do not turn on their external video ports when connected to a projector. Usually a key combination like Fn + F3 or CRT/LCD key turns the external display on/off. Locate a function key labeled CRT/LCD or a function key with a monitor symbol on the laptop. Press Fn and the labeled function key simultaneously. Refer to your laptop's documentation to discover your laptop's key combination.**



# Operation

## Starting up the projector

1. Plug the power cable into the projector and a power outlet. Turn on the power outlet switch (where fitted). The **POWER indicator light** on the projector lights orange after power has been applied.

**!** Please use the supplied power cable to avoid possible dangers such as electric shock and fire.

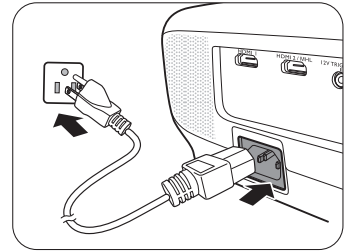

2. Press **⏻** on the projector or **⏻** on the remote control to start the projector. As soon as the lamp lights up, a **Power On Tone** will be heard. The **POWER indicator light** flashes green and stays green when the projector is on.

The fans start operating, and a start-up image is displayed on the screen while it warms up. The projector does not respond to further commands while it is warming up.

**☞** To turn off the ring tone, see [Power On/Off Ring Tone](#) for details.

3. If this is the first time you turn on the projector, the setup wizard appears to guide you through setting up the projector. If you have already done this, skip this step and move on to step 5.
  - Use the arrow keys (**◀/▶/▲/▼**) on the projector or remote control to move through the menu items.
  - Use **OK** to confirm the selected menu item.

**☞** The Setup Wizard screenshots below are for reference only and may differ from the actual design.

Step 1:

Specify **Projector Position**.

**☞** For more information about projector position, see [Choosing a location](#).

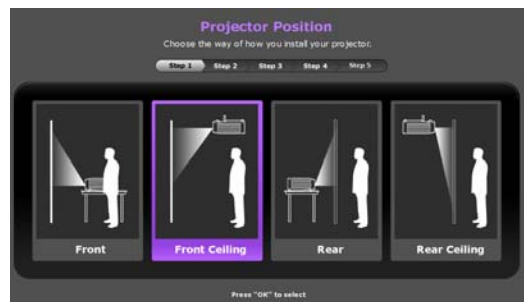

Step 2:

Specify OSD **Language**.



Step 3:  
Specify **Keystone**.

For more information about keystone, see [Correcting keystone](#).

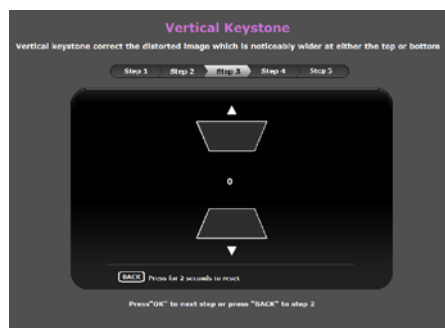

Step 4:  
Specify **Auto Source**.

Select **On** if you want the projector to always search for available signals automatically when the projector is turned on.



Step 5:  
Specify **Menu Type**.



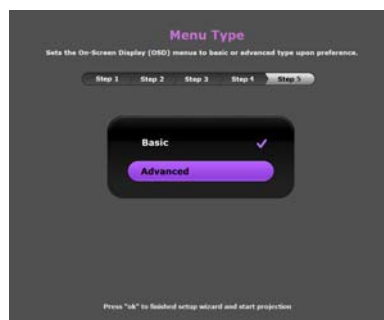

For more information about menu types, see [About the OSD Menus](#).

Now you've completed the initial setup.



4. If you are prompted to enter the password, use the arrow keys on the projector or remote control to enter a six-digit password. See [Utilizing the password function](#) for details.
5. Switch on the connected equipment.
6. The projector starts to search for available input signals. The current input signal being scanned is displayed on the screen. If the projector does not detect a valid signal, the **"No Signal"** message appears. You may press **SOURCE** on the projector or remote control to select your desired input signal.
7. If the horizontal frequency of the input source exceeds the range of the projector, the **"No Signal"** message is displayed on the screen. It will remain on-screen until you change the horizontal frequency of the input source to an appropriate one.

# Shutting down the projector

1. Press  on the projector or  on the remote control. The projector displays a shutdown confirmation message.
2. Press  or  a second time. The **POWER indicator light** flashes orange and the fans run for about two minutes to cool the lamp. The projector doesn't respond to any commands during the cooling process.
3. When the cooling process ends, a "**Power Off Ring Tone**" will be heard, and the **POWER indicator light** will show a solid orange.

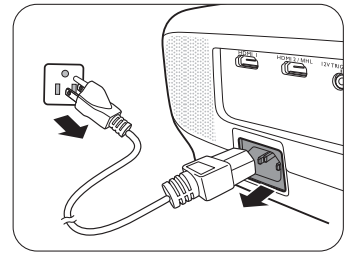

 To turn off the ring tone, see [Power On/Off Ring Tone](#) for details.

If the projector will not be used for an extended period, unplug the power cable from the power outlet.

 Avoid turning on the projector immediately after turning it off as excessive heat may shorten lamp life. The actual lamp life may vary due to different environmental conditions and usage.

# Securing the projector

## Using a security cable lock

The projector has to be installed in a safe place to prevent theft. Otherwise, purchase a lock, such as the Kensington lock, to secure the projector. You can locate a Kensington lock slot on the projector. See item 23 on page 8 for details.

A Kensington security cable lock is usually a combination of key(s) and the lock. Refer to the lock's documentation to learn how to use it.

## Utilizing the password function

For security purposes and to prevent unauthorized use, you may set up password security via the On-Screen Display (OSD) menu. Once the password is set and the function is enabled, the projector is password-protected. Users who do not know the correct password may not use the projector.

 You will be inconvenienced if you enable the password function yet forget the password somehow. Do make a note of your password, and keep the note in a safe place for later recall.

## Setting a password

 Once a password has been set and the power on lock is enabled, the projector cannot be used unless the correct password is entered every time the projector is started.

To do this, first and foremost, you have to access the **Advanced** OSD menu (see page 25 for details).

1. Go to **System Setup : Advanced > Password** to display the **Password** window.
2. Select **Change Password** and press **OK** to display the **Input New Password** window.

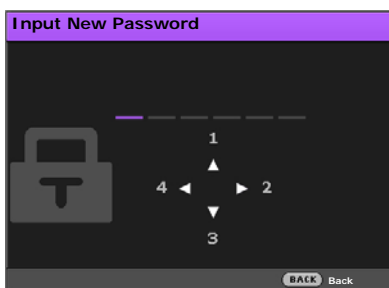

3. As the window indicates, the four arrow keys (▲/▶/▼/◀) respectively represent 4 digits (1, 2, 3, 4). Use the arrow keys on the projector or remote control to set a six-digit password. The digits are displayed as \* when you enter them.
4. Re-enter the same password to verify and return to the **Password** window.
5. Select **Power On Lock** and use ◀/▶ to set **On**.
6. Enter the current password to enable the function.
7. Press **BACK** to save your changes and exit.

## If you forget the password

If you enable the password function, you'll have to enter your password each time you turn on the projector. Once you enter an incorrect password, the error message is displayed, and the **Input Password** window follows.

- **Under the Advanced OSD menu**

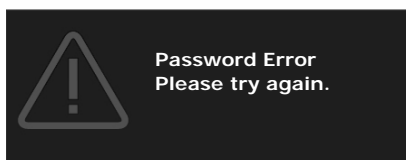

- **Under the Basic OSD menu**

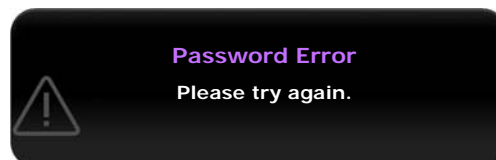

You can retry by entering another six-digit password, or if you absolutely do not remember it, use the password recall procedure. See [Entering the password recall procedure](#) for details.

If you have entered an incorrect password 5 times in succession, the projector will automatically shut down in a short time.

## Entering the password recall procedure

1. Make sure the Password window is displayed on screen, then press and hold **AUTO** on the remote control for 3 seconds. The projector will display a coded number on the screen.

- **Under the Advanced OSD menu**

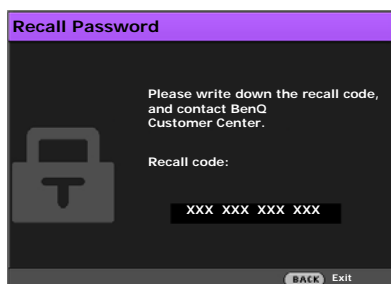

- **Under the Basic OSD menu**

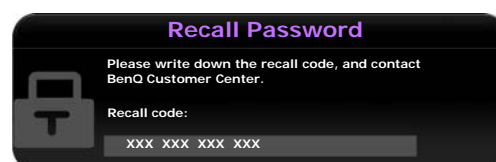

2. Write down the number and turn off the projector.
3. Seek help from the local BenQ service center to decode the number. You may be required to provide proof of purchase documentation to verify that you are an authorized user of the projector.

☞ The "XXX" shown in the above messages are numbers that vary depending on different models.

## Changing the password

To do this, first and foremost, you have to access the **Advanced** OSD menu (see page 25 for details).

1. Go to **System Setup : Advanced > Password** to display the **Password** window.
2. Select **Change Password** and press **OK** to display the **Input Current Password** window.

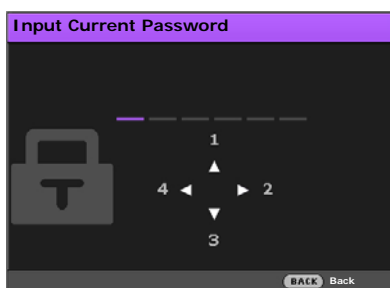

3. Use the arrow keys on the projector or remote control to enter the old password.
  - If the password is correct, the **Input New Password** window is displayed.
  - If the password is incorrect, the password error message is displayed, and the **Input Current Password** window appears for your retry. You can either try another password or press **BACK** to cancel the change.
4. Enter a new password.
5. Re-enter the same password to verify.

☞ Do make a note of your password, and then keep the note in a safe place for later recall.

6. You have successfully set a new password. Remember to enter the new password next time you turn on the projector.
7. Press **BACK** to save your changes and exit.

## Disabling the password function

To do this, first and foremost, you have to access the **Advanced** OSD menu (see page 25 for details).

1. Go to **System Setup : Advanced > Password** to display the **Password** window.
2. Select **Power On Lock** and use ◀/▶ to set **Off**.
3. Enter the current password.
  - If the password is correct, the **Password** window displays that **Power On Lock** is **Off**. You will not be asked to enter the password next time you turn on the projector.
  - If the password is incorrect, the password error message is displayed, and then the **Input Password** window is displayed for your retry. You can either try another password or press **BACK** to cancel the change.
4. Press **BACK** to save your changes and exit.

☞ Though the password function is disabled, you need to keep a note of the old password in case you ever need to re-activate the password function by entering the old password.

## Selecting an input source

The projector can be connected to multiple equipment at the same time. However, it only displays one full screen at a time. When starting up, the projector automatically searches for the available signals.

If you want the projector to always automatically search for the signals:

- Under the **Advanced** OSD menu, go to the **System Setup : Basic** menu, and enable **Auto Source**. (see "[Auto Source](#)" on page 38)
- Under the **Basic** OSD menu, if there's no signal connected to the projector, go to **Auto Source** and enable it; if there are signals connected, go to the **Settings** menu, and then enable **Auto Source**. (see "[Auto Source](#)" on page 28 and 29)

To select the video source:

1. Press **SOURCE** on the projector or remote control to display the source selection bar.



2. Press **▲/▼** until your desired signal is selected and press **OK**.  
Once detected, the selected source information is displayed on the screen for seconds. If there are multiple pieces of equipment connected to the projector, repeat steps 1-2 to search for another signal.

 **The native display resolution of this projector is in a 16:9 aspect ratio. For best display picture results, you should select and use an input signal which outputs at this resolution. Any other resolutions will be scaled by the projector depending upon the Aspect Ratio setting, which may cause some image distortion or loss of picture clarity. See "[Aspect Ratio](#)" for details.**

## Renaming an input source

You may rename the current input source on the source selection bar.

To do this, first and foremost, you have to access the **Advanced** OSD menu (see page 25 for details).

1. Press **MENU** and then use **◀/▶** to go to **System Setup : Basic**.
2. Press **▼** to select **Source Rename** and press **OK** to display the **Source Rename** window.
3. Press **▲/▼/◀/▶** until your desired character is selected.
4. When done, press **BACK** to save your changes and exit.

# Adjusting the projected image

## Adjusting the projection angle

The projector is equipped with a quick-release adjuster foot and two rear adjuster feet. These adjusters change the image height and projection angle.

To adjust the projection angle:

1. Press the quick-release button and lift the front of the projector. Once the image is positioned as desired, release the quick-release button to lock the foot in position.
2. Screw the rear adjuster feet to fine-tune the horizontal angle.

To retract the foot, hold up the projector while pressing the quick-release button, then slowly lower the projector. Screw the rear adjuster foot in a reverse direction.

 If the screen and the projector are not perpendicular to each other, the projected image becomes vertical trapezoidal. To correct this, see [Correcting keystone](#) for details.

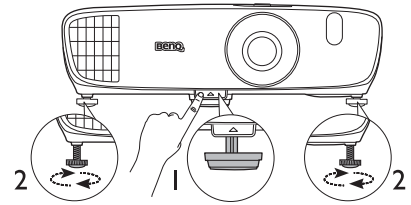

 **Do not look into the lens while the lamp is on. The strong light from the lamp may cause damage to your eyes.**

**Be careful when you press the quick-release button as it is close to the exhaust vent where hot air comes from.**

## Auto-adjusting the image

In some cases, you may wish to optimize the picture quality of PC signal. To do this, press **AUTO** on the remote control. Within 3 seconds, the built-in Intelligent Auto Adjustment function will re-adjust the values of Frequency and Clock to provide the best picture quality.

The current input source information will be displayed in the corner of the screen for 3 seconds.

 This function is only available when PC signal is selected.

## Fine-tuning the image size and clarity

### • To adjust the projected picture size:

- i. Slide open the lens compartment cover (see item 6 on page 8).
- ii. Turn the zoom ring to zoom in or zoom out.
- iii. Slide close the lens compartment cover when you complete the adjustments.

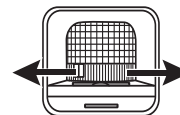
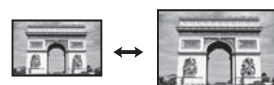

### • To sharpen the picture:

- i. Slide open the lens compartment cover (see item 6 on page 8).
- ii. Rotate the focus ring to achieve a sharper focus.
- iii. Slide close the lens compartment cover when you complete the adjustments.

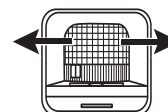
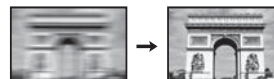



## Correcting keystone

Keystoning refers to the situation where the projected image is noticeably wider at either the top or bottom. It occurs when the projector is not perpendicular to the screen.

To correct this, besides adjusting the height of the projector, you may correct this manually in ONE of these ways:

- Use the remote control  
Press **KEYSTONE** to display the **Keystone** window.
- Using the projector  
Press **▲/▼** or **▼/▲** to display the **Keystone** window.

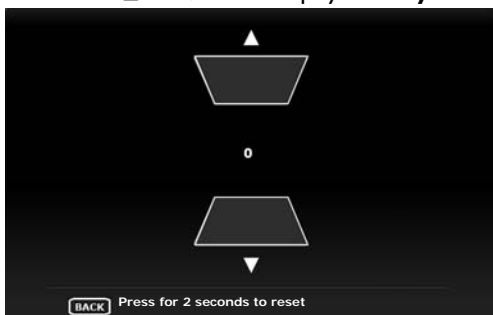

The illustrations below show how to correct keystone distortion:



- To correct keystone at the top of the image, use ▼ or ▲/▼.
- To correct keystone at the bottom of the image, use ▲ or ▲/▼.
- To reset the keystone values, press **BACK** for 2 seconds.

When done, press **BACK** to save your changes and exit.

# Menu Functions

## About the OSD Menu

To let you make various adjustments or settings on the projector and the projected image, the projector is equipped with 2 types of multilingual On-Screen Display (OSD) menus:

- **Basic** OSD menu: provides primary menu functions. (See [Using the Basic OSD menu](#))
- **Advanced** OSD menu: provides full menu functions. (See [Using the Advanced OSD menu](#))

To access the OSD menu, press **MENU** on the projector or remote control.

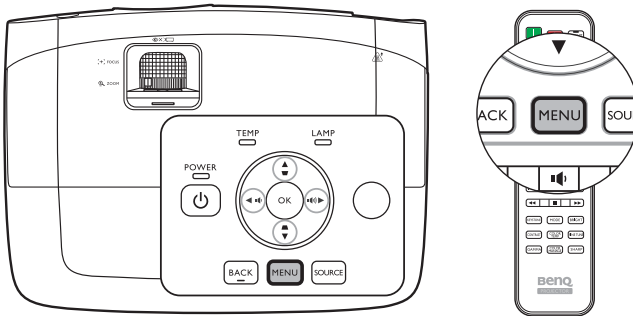

The first time you use the projector (after finishing the initial setup), one of the following **Basic** OSD menu overviews will be displayed, depending on whether or not a video signal is connected.

### • Input signal connected

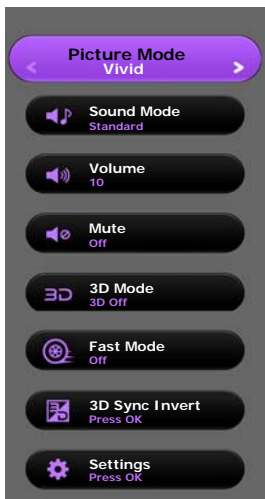

### • No input signal connected



If you intend to switch from the **Basic** OSD menu to the **Advanced** OSD menu, follow the instructions below:

☞ Use the arrow keys (◀/▶/▲/▼) on the projector or remote control to move through the menu items, and use **OK** to confirm the selected menu item.

- When there is a video signal connected to the projector
  - i. Go to the **Settings > Menu Type** menu and press **OK**.
  - ii. Use ▲/▼ to select **Advanced** and press **OK**.
  - iii. Press **BACK** again to access the **Advanced** OSD menu.
- When there is **NO** video signal connected to the projector
  - i. Go to the **Menu Type** menu and press **OK**.
  - ii. Use ▲/▼ to select **Advanced** and press **OK**.
  - iii. Press **BACK** again to access the **Advanced** OSD menu.

Next time you turn on the projector, you may access the **Advanced** OSD menu by pressing **MENU**.

Below is the overview of the **Advanced** OSD menu.



Likewise, when you wish to switch from the **Advanced** OSD menu to the **Basic** OSD menu, follow the instructions below:

- i. Go to the **System Setup : Basic > Menu Settings > Menu Type** menu and press **OK**.
- ii. Use ◀/▶ to select **Basic** to directly access the **Basic** OSD menu.

Next time you turn on the projector, you may access the **Basic** OSD menu by pressing **MENU**.

# Using the **Basic** OSD menu

Depending on whether or not any video signal is connected to the projector, the **Basic** OSD menu offers different available functions.

Check the following links to learn more.

- [Basic OSD menu - with input signals connected](#)
- [Basic OSD menu - without input signals connected](#) (limited menus are available)

## Basic OSD menu - with input signals connected









The **Basic** OSD menu provides primary menu functions. Available menu items may vary depending on the connected video sources or specified settings. Menu options that are not available will become grayed out.





To access the OSD menu, press **MENU** on the projector or remote control.

- Use the arrow keys (◀/▶/▲/▼) on the projector or remote control to move through the menu items.
- Use **OK** on the projector or remote control to confirm the selected menu item.

To switch from the **Basic OSD** menu to the **Advanced OSD** menu, see [page 25](#).

Menu	Submenus and Descriptions
<p><b>Picture Mode</b></p>	<p>Selects a preset picture mode to suit your operating environment and input signal picture type.</p> <p>The preset picture modes are described as below:</p> <ul style="list-style-type: none"> <li>• <b>Bright:</b> Maximizes the brightness of the projected image. This mode is suitable for environments where extra-high brightness is required, such as using the projector in well lit rooms.</li> <li>• <b>Vivid:</b> With well-saturated color, fine-tuned sharpness and a higher brightness level, this is perfect for watching movies in a living room where there is a small amount of ambient light.</li> <li>• <b>Cinema:</b> With well-balanced color saturation and contrast with a low brightness level, this is most suitable for enjoying movies in a totally dark environment (as you would find in a commercial cinema).</li> <li>• <b>Game:</b> Suitable for playing video games in rooms with a small amount of ambient light.</li> <li>• <b>Game (Bright):</b> Suitable for playing video games in a bright living room.</li> <li>• <b>3D:</b> Optimized to bring up 3D effects when watching 3D contents.</li> </ul> <p> <b>This mode is only available when 3D function is enabled.</b></p> <ul style="list-style-type: none"> <li>• <b>User:</b> Recalls the customized settings. Access the <b>Advanced</b> OSD menu and see <a href="#">User Mode Management</a> for details.</li> </ul> <p> <b>The function is accessible through the remote control.</b></p>

<p><b>Sound Mode</b></p>	<p><b>Sound Mode</b> function utilizes MaxxAudio sound enhancement technology, which incorporates Waves's algorithms to deliver great effects of the bass and treble and provide you with immersive cinematic audio experience. The following preset sound modes are provided: <b>Standard, Cinema, Music, Sport, Game,</b> and <b>User</b>.</p> <p>The <b>User</b> mode allows you to personalize the sound settings. Access the <b>Advanced</b> OSD menu and see <a href="#">User EQ</a> for details.</p> <p> <b>If the Mute function is activated, adjusting Sound Mode will turn off the Mute function.</b></p>
<p><b>Volume</b></p>	<p>Adjusts the volume level of the projector's internal speaker or the volume being output from the audio output jack.</p> <p> <b>If the Mute function is activated, adjusting Volume will turn off the Mute function.</b></p> <p> <b>The function is accessible through the remote control.</b></p>
<p><b>Mute</b></p>	<p>Select <b>On</b> to temporarily turn off the projector's internal speaker or the volume being output from the audio output jack.</p> <p>To restore the audio, select <b>Off</b>.</p> <p> <b>The function is accessible through the remote control.</b></p>
<p><b>Fast Mode</b></p>	<p>Reduces frame delay. The lag between the signal input and output will be minimized to the lowest level.</p> <p> <b>Select an HDMI signal at 1080p/60Hz to use this function. Aspect Ratio will be set to Auto, and Overscan Adjustment will be set to 0 during operation.</b></p>
<p><b>3D Mode</b></p>	<p>This projector supports playing three-dimensional (3D) content transferred through your 3D-compatible video devices and contents, such as PlayStation consoles (with 3D game discs), 3D Blu-ray players (with 3D Blu-ray discs), 3D TV (with 3D channel), and so on. After you have connected the 3D video devices to the projector, wear the BenQ 3D glasses and make sure the power is on to view 3D contents.</p> <p> <b>When watching 3D contents,</b></p> <ul style="list-style-type: none"> <li>• the image may seem misplaced, however, this is not a product malfunction.</li> <li>• take appropriate breaks when watching 3D content.</li> <li>• stop watching 3D content if you feel fatigue or discomfort.</li> <li>• keep a distance from the screen of about three times the effective height of the screen.</li> <li>• children and people with a history of oversensitivity to light, heart problems, or any other existing medical condition should be refrained from watching 3D contents.</li> </ul> <p>The default setting is <b>Auto</b> and the projector automatically chooses an appropriate 3D format when detecting 3D contents. If the projector cannot recognize the 3D format, manually choose a 3D mode according to your preference.</p> <p> <b>When this function is enabled:</b></p> <ul style="list-style-type: none"> <li>• The brightness level of the projected image decreases.</li> <li>• The Picture Mode cannot be adjusted.</li> <li>• The Vertical Keystone can only be adjusted within limited degrees.</li> </ul> <p> <b>The function is accessible through the remote control.</b></p>
<p><b>3D Sync Invert</b></p>	<p>When your 3D image is distorted, enable this function to switch between the image for the left eye and the right eye for comfortable 3D viewing experience.</p> <p> <b>The function is accessible through the remote control.</b></p>

<b>Settings</b>	<p>Press <b>OK</b> to enter its submenu.</p> <p>Press <b>BACK</b> to save your changes and exit.</p> <p>See below for more details.</p>
<ul style="list-style-type: none"> <li>• <b>Wall Color</b></li> </ul>	<p>Enable this function to help correct the projected picture's color when the projection surface is not white. You may choose a color similar to that of the projection surface from these options: <b>Light Yellow, Pink, Light Green, or Blue.</b></p>
<ul style="list-style-type: none"> <li>• <b>Projector Position</b></li> </ul>	<p>The projector can be installed on a ceiling or behind a screen, or with one or more mirrors. See <a href="#">Choosing a location</a> for details.</p>
<ul style="list-style-type: none"> <li>• <b>Test Pattern</b></li> </ul>	<p>Enable this function to display the grid test pattern, which helps you adjust the image size and focus so as to check if the projected image is free of distortion.</p>
<ul style="list-style-type: none"> <li>• <b>Auto Source</b></li> </ul>	<p>Sets whether the projector searches automatically for input sources. Select <b>On</b> to enable the projector to scan for input sources until it acquires a signal. If the function is set to <b>Off</b>, the projector selects the last used input source.</p>
<ul style="list-style-type: none"> <li>• <b>Menu Type</b></li> </ul>	<p>Switches to the <b>Advanced</b> OSD menu.</p>
<ul style="list-style-type: none"> <li>• <b>HDMI Range</b></li> </ul>	<p>Selects a suitable RGB color range to correct the color accuracy.</p> <ul style="list-style-type: none"> <li>• <b>Auto:</b> Automatically selects a suitable color range for the incoming HDMI signal.</li> <li>• <b>Full:</b> Utilizes the Full range RGB 0-255.</li> <li>• <b>Limited:</b> Utilizes the Limited range RGB 16-235.</li> </ul> <p> <b>HDMI Range is only available when the HDMI signal is selected.</b></p>
<ul style="list-style-type: none"> <li>• <b>Reset Lamp Timer</b></li> </ul>	<p>Activate this function only after a new lamp is installed. When you select <b>Reset</b>, a "<b>Reset Successfully</b>" message is displayed to notify that the lamp time has been reset to "0".</p>
<ul style="list-style-type: none"> <li>• <b>Reset All Settings</b></li> </ul>	<p>Returns all settings to the factory preset values.</p> <p> <b>The following settings will still remain: Keystone, Language, Projector Position, Reset Lamp Timer, and High Altitude Mode.</b></p>
<ul style="list-style-type: none"> <li>• <b>Information</b></li> </ul>	<p>Displays the following information about your projector.</p> <ul style="list-style-type: none"> <li>• <b>Source:</b> Displays the current signal source.</li> <li>• <b>Picture Mode:</b> Displays the current <b>Picture Mode</b>.</li> <li>• <b>Resolution:</b> Displays the native resolution of the input source.</li> <li>• <b>Color System:</b> Displays input system format.</li> <li>• <b>Lamp Usage Time:</b> Displays the number of hours the lamp has been used.</li> <li>• <b>3D Format:</b> Displays the current 3D mode.</li> </ul> <p> <b>3D Format is only available when 3D Mode is enabled.</b></p> <ul style="list-style-type: none"> <li>• <b>Firmware Version:</b> Displays the firmware version of your projector.</li> </ul> <p> <b>Some information is given only when certain input sources are in use.</b></p>

## Basic OSD menu - without input signals connected

As there's no input signal to your projector, only the submenus of **Settings** under **Basic** OSD menu - with input signals connected are available. Menu options that are not available will become grayed out.

To access the OSD menu, press **MENU** on the projector or remote control.

- Use the arrow keys (◀/▶/▲/▼) on the projector or remote control to move through the menu items.
- Use **OK** on the projector or remote control to confirm the selected menu item.
- Use **BACK** on the projector or remote control to save your changes and exit.

To switch from the **Basic OSD** menu to the **Advanced OSD** menu, see [page 25](#).

Menu	Submenus and Descriptions
<b>Wall Color</b>	Activate to help correct the projected picture's color when the projection surface is not white. You may choose a color similar to that of the projection surface from these options: <b>Light Yellow</b> , <b>Pink</b> , <b>Light Green</b> , or <b>Blue</b> .
<b>Projector Position</b>	The projector can be installed on a ceiling or behind a screen, or with one or more mirrors. See <a href="#">Choosing a location</a> for details.
<b>Test Pattern</b>	Enable this function to display the grid test pattern, which helps you adjust the image size and focus so as to check if the projected image is free of distortion.
<b>Auto Source</b>	Sets whether the projector searches automatically for input sources. Select <b>On</b> to enable the projector to scan for input sources until it acquires a signal. If the function is set to <b>Off</b> , the projector selects the last used input source.
<b>Menu Type</b>	Switches to the <b>Advanced</b> OSD menu.
<b>HDMI Range</b>	Selects a suitable RGB color range to correct the color accuracy. <ul style="list-style-type: none"> <li>• <b>Auto</b>: Automatically selects a suitable color range for the incoming HDMI signal.</li> <li>• <b>Full</b>: Utilizes the Full range RGB 0-255.</li> <li>• <b>Limited</b>: Utilizes the Limited range RGB 16-235.</li> </ul> <b>HDMI Range is only available when the HDMI signal is selected.</b>
<b>Reset Lamp Timer</b>	Activate this function only after a new lamp is installed. When you select <b>Reset</b> , a " <b>Reset Successfully</b> " message is displayed to notify that the lamp time has been reset to "0".
<b>Reset All Settings</b>	Returns all settings to the factory preset values. <b>The following settings will still remain: Keystone, Language, Projector Position, Reset Lamp Timer, and High Altitude Mode.</b>
<b>Information</b>	Displays the following information about your projector. <ul style="list-style-type: none"> <li>• <b>Source</b>: Displays the current signal source.</li> <li>• <b>Picture Mode</b>: Displays the current <b>Picture Mode</b>.</li> <li>• <b>Resolution</b>: Displays the native resolution of the input source.</li> <li>• <b>Color System</b>: Displays input system format.</li> <li>• <b>Lamp Usage Time</b>: Displays the number of hours the lamp has been used.</li> <li>• <b>3D Format</b>: Displays the current 3D mode.</li> </ul> <b>3D Format is only available when 3D Mode is enabled.</b> <ul style="list-style-type: none"> <li>• <b>Firmware Version</b>: Displays the firmware version of your projector.</li> </ul> <b>Some information is given only when certain input sources are in use.</b>



# Using the Advanced OSD menu

The **Advanced** OSD menu offers complete menu functions.

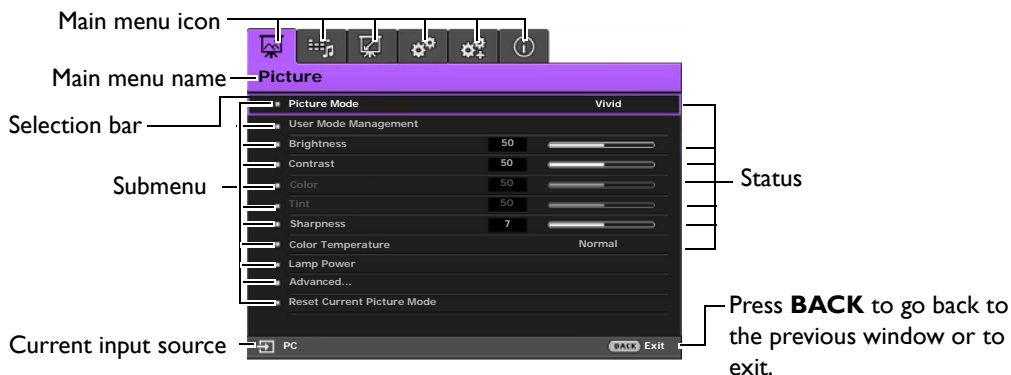

The Advanced OSD menu overview above is for reference only and may differ from the actual design and the projector model you are using.

To access the OSD menu, press **MENU** on the projector or remote control. It consists of the following main menus. Check the links after the menu items below to learn more details.



1. **Picture** menu (see page 31)
2. **Audio Setup** menu (see page 35)
3. **Display** menu (see page 36)
4. **System Setup : Basic** menu (see page 38)
5. **System Setup : Advanced** menu (see page 39)
6. **Information** menu (see page 41)







Available menu items may vary depending on the connected video sources or specified settings. Menu items that are not available will become grayed out.

- Use the arrow keys (◀/▶/▲/▼) on the projector or remote control to move through the menu items.
- Use **OK** on the projector or remote control to confirm the selected menu item.

To switch from the **Advanced OSD** menu to the **Basic OSD** menu, see page 25.

## Picture menu

Submenu	Functions and Descriptions
<p><b>Picture Mode</b></p>	<p>Selects a preset picture mode to suit your operating environment and input signal picture type.</p> <p>The preset picture modes are described as below:</p> <ul style="list-style-type: none"> <li>• <b>Bright:</b> Maximizes the brightness of the projected image. This mode is suitable for environments where extra-high brightness is required, such as using the projector in well lit rooms.</li> <li>• <b>Vivid:</b> With well-saturated color, fine-tuned sharpness and a higher brightness level, this is perfect for watching movies in a living room where there is a small amount of ambient light.</li> <li>• <b>Cinema:</b> With well-balanced color saturation and contrast with a low brightness level, this is most suitable for enjoying movies in a totally dark environment (as you would find in a commercial cinema).</li> <li>• <b>Game:</b> Suitable for playing video games in rooms with a small amount of ambient light.</li> <li>• <b>Game (Bright):</b> Suitable for playing video games in a bright living room.</li> <li>• <b>3D:</b> Optimized to bring up 3D effects when watching 3D contents.</li> </ul> <p> <b>This mode is only available when 3D function is enabled.</b></p> <ul style="list-style-type: none"> <li>• <b>User:</b> Recalls the customized settings. See <a href="#">User Mode Management</a> for more details.</li> </ul> <p> <b>The function is accessible through the remote control.</b></p>
<p><b>User Mode Management</b></p>	<p> <b>The functions are only available when Picture Mode is set to User.</b></p> <ul style="list-style-type: none"> <li>• <b>Load Settings From</b></li> </ul> <p>Allows you to manually adjust a preset picture mode and make it an available option on the picture mode list.</p> <ol style="list-style-type: none"> <li>1. Go to the <b>Picture &gt; Picture Mode</b> menu, select <b>User</b>.</li> <li>2. Press <b>▼</b> to select <b>User Mode Management</b>.</li> <li>3. On the <b>User Mode Management</b> window, select <b>Load Settings From</b> and press <b>OK</b>.</li> <li>4. Press <b>▼</b> to select a picture mode that is close to your need.</li> <li>5. When done, press <b>OK</b> and <b>BACK</b> to return to the <b>Picture</b> menu.</li> <li>6. Press <b>▼</b> to select other submenus you want to make changes and use <b>◀/▶</b> to adjust the values. The adjustments define the selected user mode.</li> </ol> <ul style="list-style-type: none"> <li>• <b>Rename User Mode</b></li> </ul> <p>Select to rename the customized picture modes.</p> <ol style="list-style-type: none"> <li>1. Go to the <b>Picture &gt; Picture Mode</b> menu, select <b>User</b>.</li> <li>2. Press <b>▼</b> to select <b>User Mode Management</b>.</li> <li>3. On the <b>User Mode Management</b> window, select <b>Rename User Mode</b> and press <b>OK</b>.</li> <li>4. On the <b>Rename User Mode</b> window, use <b>▲/▼/◀/▶</b> to select desired characters for the selected mode.</li> <li>5. When done, press <b>OK</b> and <b>BACK</b> to exit.</li> </ol>

<p><b>Brightness</b></p>	<p>Adjusts the brightness of the picture. When adjusting this control, the black areas of the picture appear just as black and details in the dark areas are visible.</p>  <p>The higher the value, the brighter the picture, while the lower the value, the darker the picture.</p> <p> <b>The function is accessible through the remote control.</b></p>
<p><b>Contrast</b></p>	<p>Adjusts the degree of difference between dark and light areas in the picture. After adjusting the <b>Brightness</b> value, adjust <b>Contrast</b> to set the peak white level.</p>  <p>The higher the value, the greater the contrast.</p> <p> <b>The function is accessible through the remote control.</b></p>
<p><b>Color</b></p>	<p>Adjusts the color saturation level - the amount of each color in a video picture. Lower settings produce less saturated colors; setting to the minimum value makes the image black and white.</p> <p>If the setting is too high, colors on the image will be overpowering, which makes the image unrealistic.</p>
<p><b>Tint</b></p>	<p>Adjusts the red and green color tones of the picture.</p> <p>The higher the value, the more reddish the picture becomes. The lower the value, the more greenish the picture becomes.</p>
<p><b>Sharpness</b></p>	<p>Adjust to make the picture look sharper or softer.</p>  <p>The higher the value, the sharper the picture becomes. The lower the value, the softer the picture becomes.</p> <p> <b>The function is accessible through the remote control.</b></p>
<p><b>Color Temperature*</b></p>	<p>The options available for color temperature* settings vary according to the connected input signal.</p> <ul style="list-style-type: none"> <li>• <b>Lamp Native:</b> With the lamp's original color temperature and higher brightness. This setting is suitable for environments where high brightness is required, such as projecting pictures in well lit rooms.</li> <li>• <b>Warm:</b> Makes pictures appear reddish white.</li> <li>• <b>Normal:</b> Maintains normal colorings for white.</li> <li>• <b>Cool:</b> Makes pictures appear bluish white.</li> </ul> <p>*About color temperatures: There are many different shades that are considered to be "white" for various purposes. One of the common methods of representing white color is known as the "color temperature". A white color with a low color temperature appears to be reddish white. A white color with a high color temperature appears to have more blue in it.</p> <p> <b>The function is accessible through the remote control.</b></p>

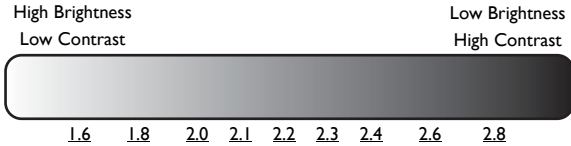
<p><b>Lamp Power</b></p>	<p>Select the projector lamp power from the following modes.</p> <ul style="list-style-type: none"><li>• <b>Normal:</b> Provides full lamp brightness.</li><li>• <b>Economic:</b> Reduces system noise and lamp power consumption by 30%.</li><li>• <b>SmartEco:</b> Reduces system noise and lamp power consumption by up to 70%.</li></ul> <p>If the <b>Economic</b> or <b>SmartEco</b> mode is selected, the light output will be reduced and result in darker projected pictures.</p> <p>See <a href="#">Setting Lamp Power</a> for details.</p>
<p><b>Advanced...</b></p>	<ul style="list-style-type: none"><li>• <b>Gamma Selection</b></li></ul> <p>Gamma refers to the relationship between input source and picture brightness.</p> <ul style="list-style-type: none"><li>• <b>1.6/1.8/2.0/2.1/BenQ:</b> Select these values according to your preference.</li><li>• <b>2.2/2.3:</b> Increases the average brightness of the picture. Best for a lit environment, meeting room or family room.</li><li>• <b>2.4:</b> Best for viewing movies in a dark environment.</li><li>• <b>2.6/2.8:</b> Best for viewing movies which are mostly composed of dark scenes.</li></ul>  <ul style="list-style-type: none"><li>• <b>Brilliant Color</b></li></ul> <p>This function utilizes a new color-processing algorithm and system level enhancements to enable higher brightness while providing truer, more vibrant colors in picture. It enables a greater than 50% brightness increase in mid-tone images, which are common in video and natural scenes, so the projector reproduces images in realistic and true colors. If you prefer images with that quality, select <b>On</b>. Selecting <b>Off</b> disables <b>Brilliant Color</b>, and <b>Color Temperature</b> becomes unavailable for access at the same time.</p> <ul style="list-style-type: none"><li>• <b>Color Temperature Fine Tuning</b></li></ul> <p>Allows you to manually adjust the pre-defined color temperature modes:</p> <ol style="list-style-type: none"><li>1. Press <b>OK</b> to display the <b>Color Temperature Fine Tuning</b> window.</li><li>2. Press <b>▲/▼</b> to select the item(s) you want to make changes and use <b>◀/▶</b> to adjust the values.<ul style="list-style-type: none"><li>• <b>Red Gain/Green Gain/Blue Gain:</b> Adjusts the contrast levels of Red, Green, and Blue.</li><li>• <b>Red Offset/Green Offset/Blue Offset:</b> Adjusts the brightness levels of Red, Green, and Blue.</li></ul></li><li>3. When done, press <b>BACK</b> to save your changes and exit.</li></ol> <p>☞ <b>The function is accessible through the remote control.</b></p>

Advanced...  
(Continued)

• **Color Management**

In most installation situations, color management is not necessary, such as in classroom, meeting room, or lounge room situations where lights remain on, or where building external windows allow daylight into the room.

Only in permanent installations with controlled lighting levels, such as boardrooms, lecture theaters, or home theaters, should color management be considered. Color management provides fine color control adjustment to allow for more accurate color reproduction.

Proper color management can be achieved under controlled and reproducible viewing conditions. Use a colorimeter (color light meter) and provide a set of suitable source images to measure color reproduction. These tools are not provided with the projector, however, your projector supplier should be able to give guidances or send an experienced professional installer for you.

The **Color Management** function provides six sets (RGBCMY) of colors to be adjusted. You can select any of them to adjust its color range and saturation.

1. Press **OK** to display the **Color Management** window.
2. Select **Primary Color** and use ◀/▶ to select a color from **Red, Green, Blue, Cyan, Magenta, and Yellow**.
3. Press ▼ to select **Hue** and use ◀/▶ to set its range. Increase in the range will include colors consisted of more proportions of its two adjacent colors.

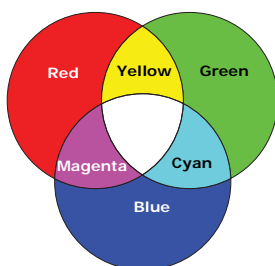

The illustration shows how the colors relate to each other.

For example, if you select **Red** and set its range at 0, only pure red is selected. Increasing its range will include both the red color close to yellow and red color close to magenta.

4. Press ▼ to select **Saturation\*** and use ◀/▶ to adjust its values. Every adjustment made reflects to the image immediately. For example, if you select **Red** and set its value at 0, only the saturation of pure red will be affected.
5. Press ▼ to select **Gain** and use ◀/▶ to adjust its values. The contrast level of the primary color you just selected are affected. Every adjustment made reflects to the image immediately.
6. Repeat steps 2 to 5 until you have made all of the desired adjustments.
7. When done, press **BACK** to save your changes and exit.

\*About saturation

It is the amount of that color in a video picture. Lower settings produce less saturated colors; a setting of "0" removes that color from the image entirely. If the saturation is too high, that color will be overpowering and unrealistic.

☞ **The function is accessible through the remote control.**

• **Noise Reduction**



Reduces electrical image noise caused by different media players. The higher the value, the less the noise.





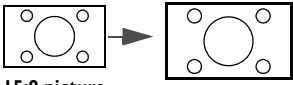
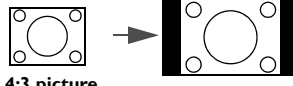
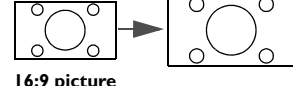
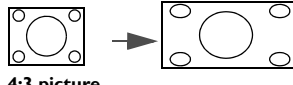
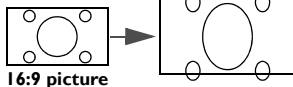
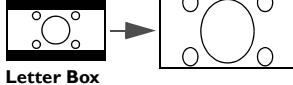

<p><b>Advanced... (Continued)</b></p>	<ul style="list-style-type: none"> <li>• <b>Fast Mode</b> Reduces frame delay. The lag between the signal input and output will be minimized to the lowest level.  <b>Select an HDMI signal at 1080p/60Hz to use this function. Aspect Ratio will be set to Auto, and Overscan Adjustment will be set to 0 during operation.</b></li> <li>• <b>Film Mode</b> Enhances picture quality when projecting composite image from a filmsourced DVD or Blu-ray Disc. Setting <b>Off</b> disables the function.</li> </ul>
<p><b>Reset Current Picture Mode</b></p>	<p>All of the adjustments you've made for the selected <b>Picture Mode</b> (including preset modes, and <b>User</b>) return to the factory preset values.</p> <ol style="list-style-type: none"> <li>1. Press <b>OK</b>. The confirmation message is displayed.</li> <li>2. Use <b>◀/▶</b> to select <b>Reset</b> and press <b>OK</b>. The picture mode returns to the factory preset settings.</li> <li>3. Repeat steps 1 and 2 if you want to reset other picture modes.</li> </ol>

## Audio Setup menu

Submenu	Functions and Descriptions
<p><b>Sound Mode</b></p>	<ul style="list-style-type: none"> <li>• <b>Effect Mode</b> <b>Sound Mode</b> function utilizes MaxxAudio sound enhancement technology, which incorporates Waves's algorithms to deliver great effects of the bass and treble and provide you with immersive cinematic audio experience. The following preset sound modes are provided: <b>Standard, Cinema, Music, Sport, Game,</b> and <b>User</b>. The <b>User</b> mode allows you to personalize the sound settings. When selecting the <b>User</b> mode, you may make manual adjustments with the <b>User EQ</b> function.  <b>If the Mute function is activated, adjusting Sound Mode will turn off the Mute function.</b></li> <li>• <b>User EQ</b> Select desired frequency bands (100 Hz, 300 Hz, 1k Hz, 3k Hz, and 10k Hz) to adjust the levels according to your preference. The settings made here define the <b>User</b> mode.</li> </ul>
<p><b>Mute</b></p>	<p>Select <b>On</b> to temporarily turn off the projector's internal speaker or the volume being output from the audio output jack. To restore the audio, select <b>Off</b>.  <b>The function is accessible through the remote control.</b></p>
<p><b>Volume</b></p>	<p>Adjusts the volume level of the projector's internal speaker or the volume being output from the audio output jack.  <b>If the Mute function is activated, adjusting Mute will turn off the Mute function.</b>  <b>The function is accessible through the remote control.</b></p>
<p><b>Power On/Off Ring Tone</b></p>	<p>Sets the ring tone for the projector <b>On</b> or <b>Off</b>.  <b>The Power On/Off Ring Tone can only be adjusted here. Setting the sound mute or adjusting the sound level do not affect the Power On/Off Ring Tone.</b></p>
<p><b>Reset Audio Settings</b></p>	<p>All of the adjustments you've done under the <b>Audio Setup</b> menu return to the factory preset values.</p>







# Display menu

Submenu	Functions and Descriptions
<p><b>Aspect Ratio</b></p>	<p>The native display resolution of this projector is in a 16:9 aspect ratio. However, you may use this function to display projected picture in a different aspect ratio.</p> <p> In the following illustrations, the black portions are inactive areas and the white portions are active areas.</p> <ul style="list-style-type: none"> <li> <p><b>Auto</b></p>  <p>15:9 picture</p> <p>Scales a picture proportionally to fit the projector's native resolution in its horizontal or vertical width. This makes the most use of the screen and maintains the aspect ratio of a picture.</p> </li> <li> <p><b>4:3</b></p>  <p>4:3 picture</p> <p>Scales the picture so that it is displayed in the center of the screen with a 4:3 aspect ratio.</p> </li> <li> <p><b>16:9</b></p>  <p>16:9 picture</p> <p>Scales a picture so that it is displayed in the center of the screen with a 16:9 aspect ratio.</p> </li> <li> <p><b>Wide</b></p>  <p>4:3 picture</p> <p>Stretches a picture in a horizontal direction to fit the screen width. It does not alter the height of a picture.</p> </li> <li> <p><b>Letter Box</b></p>  <p>16:9 picture</p>  <p>Letter Box format picture</p> <p>Scales a picture to fit the projector's native resolution in its horizontal width and resizes the picture height to the 3/4 of the projection width. This makes a picture greater than the screen height. The top and bottom edges of the displayed picture are cropped. This suits the contents which are produced in letter box format (with black bars on the top and bottom).</p> </li> </ul>
<p><b>Wall Color</b></p>	<p>Enable this function to help correct the projected picture's color when the projection surface is not white. You may choose a color similar to that of the projection surface from these options: <b>Light Yellow, Pink, Light Green, or Blue.</b></p>
<p><b>Image Position</b></p>	<p>Displays the <b>Image Position</b> window. You may use the directional arrow keys on the projector or remote control to adjust the position of the projected picture.</p> <p>The values shown on the lower position of the window change with every key press you made.</p> <p> <b>This function is only available when the PC signal is selected.</b></p>
<p><b>Overscan Adjustment</b></p>	<p>Conceals the poor picture quality in the four edges.</p> <p>The greater the value, the more portion of the picture is concealed while the screen remains filled and geometrically accurate. Setting 0 means the picture is 100% displayed.</p>

<p><b>PC &amp; Component YPbPr Tuning</b></p>	<ul style="list-style-type: none"> <li>• <b>H. Size</b> Adjusts the horizontal width of the picture.  <b>This function is only available when the Component or PC signal is selected.</b></li> <li>• <b>Phase</b> Adjusts the clock phase to reduce picture distortion.  <b>This function is only available when the Component or PC signal is selected.</b></li> <li>• <b>Auto</b> Adjusts the phase and frequency automatically.  <b>This function is only available when the PC signal is selected.</b></li> </ul>
<p><b>3D</b></p>	<p>This projector supports playing three-dimensional (3D) content transferred through your 3D-compatible video devices and contents, such as PlayStation consoles (with 3D game discs), 3D Blu-ray players (with 3D Blu-ray discs), 3D TV (with 3D channel), and so on. After you have connected the 3D video devices to the projector, wear the BenQ 3D glasses and make sure the power is on to view 3D contents.</p> <p> <b>When watching 3D contents,</b></p> <ul style="list-style-type: none"> <li>• the image may seem misplaced, however, this is not a product malfunction.</li> <li>• take appropriate breaks when watching 3D content.</li> <li>• stop watching 3D content if you feel fatigue or discomfort.</li> <li>• keep a distance from the screen of about three times the effective height of the screen.</li> <li>• children and people with a history of oversensitivity to light, heart problems, or any other existing medical condition should be refrained from watching 3D contents.</li> </ul> <p>The following functions help enhance your 3D viewing experience.</p> <ul style="list-style-type: none"> <li>• <b>3D Mode</b> The default setting is <b>Auto</b> and the projector automatically chooses an appropriate 3D format when detecting 3D contents. If the projector cannot recognize the 3D format, manually choose a 3D mode according to your preference.  <b>When this function is enabled:</b> <ul style="list-style-type: none"> <li>• the brightness level of the projected image decreases.</li> <li>• the <b>Picture Mode</b> cannot be adjusted.</li> <li>• the <b>Keystone</b> can only be adjusted within limited degrees.</li> </ul> </li> <li>• <b>3D Sync Invert</b> When your 3D image is distorted, enable this function to switch between the image for the left eye and the right eye for more comfortable 3D viewing experience.  <b>These functions are accessible through the remote control.</b></li> </ul>











## System Setup : Basic menu

Submenu	Functions and Descriptions
<b>Language</b>	Sets the language for the On-Screen Display (OSD) menus.
<b>Background Color</b>	Sets the background color when there is no signal to the projector.
<b>Splash Screen</b>	Allows you to select which logo screen is displayed during projector start-up. You can choose <b>BenQ</b> logo screen, <b>Blue</b> screen, or <b>Black</b> screen.
<b>Projector Position</b>	The projector can be installed on a ceiling or behind a screen, or with one or more mirrors. See <a href="#">Choosing a location</a> for details.
<b>Auto Off</b>	Prevents unnecessary projection when no signal is detected for a long time. See <a href="#">Setting Auto Off</a> for details.
<b>Direct Power On</b>	When the function is set to <b>On</b> , the projector will be turned on automatically once the power is fed through the power cable. When the function is set to <b>Off</b> , you'll have to turn on the projector by pressing  on the projector or  on the remote control.
<b>Menu Settings</b>	<ul style="list-style-type: none"> <li>• <b>Menu Type</b> Switches to the <b>Basic</b> OSD menu.</li> <li>• <b>Menu Position</b> Sets the OSD menu position.</li> <li>• <b>Menu Display Time</b> Sets the length of time the OSD will remain active after your last key press.</li> <li>• <b>Blank Reminder Message</b> Sets whether the reminder message is displayed by the projector while the image is hidden.</li> </ul>
<b>Source Rename</b>	<p>Renames the current input source to your desired name.</p> <p>On the <b>Source Rename</b> window, use /// to set the desired characters for the connected source item.</p> <p>When done, press <b>OK</b> to save the changes.</p>
<b>Auto Source</b>	<p>Sets whether the projector searches automatically for input sources.</p> <p>Select <b>On</b> to enable the projector to scan for input sources until it acquires a signal. If the function is set to <b>Off</b>, the projector will select the last used input source.</p>

## System Setup : Advanced menu

Submenu	Functions and Descriptions						
Lamp Settings	<ul style="list-style-type: none"> <li>• <b>Reset Lamp Timer</b> Activate this function only after a new lamp is installed. When you select <b>Reset</b>, a "<b>Reset Successfully</b>" message is displayed to notify that the lamp time has been reset to "0".</li> <li>• <b>Lamp Timer</b> Select to learn the duration (in hours) of lamp usage which is automatically calculated by the built-in timer. Total (equivalent) lamp hour = 2.0 x (hours used in <b>Normal</b> mode) + 1.4 x (hours used in <b>Economic</b> mode) + 1.0 x (hours used in <b>SmartEco</b> mode)</li> </ul>						
HDMI Settings	<ul style="list-style-type: none"> <li>• <b>HDMI Range</b> Selects a suitable RGB color range to correct the color accuracy. <ul style="list-style-type: none"> <li>• <b>Auto</b>: Automatically selects a suitable color range for the incoming HDMI signal.</li> <li>• <b>Full</b>: Utilizes the Full range RGB 0-255.</li> <li>• <b>Limited</b>: Utilizes the Limited range RGB 16-235.</li> </ul> <p> <b>HDMI Range is only available when the HDMI signal is selected.</b></p> </li> <li>• <b>CEC</b> When you connect an HDMI CEC-compatible device to your projector with an HDMI cable, turning on the HDMI CEC compatible device automatically turns on the projector, while turning off the projector automatically turns off the HDMI CEC compatible device. You can use the projector's remote control to control your HDMI CEC-compatible devices. See item 17 on page 10 for details.</li> <li>• <b>Power On Link/Power Off Link</b> When you connect an HDMI CEC-compatible device to your projector with an HDMI cable, you can set the behavior of powering on/off between the device and the projector. <table border="1" data-bbox="463 1180 1236 1380"> <tbody> <tr> <td><b>Bidirectional</b></td> <td>Turning on/off either the connected device or the projector can turn on/off both.</td> </tr> <tr> <td><b>From Projector</b></td> <td>When the projector is turned on/off, the connected device will be activated/shut down, too.</td> </tr> <tr> <td><b>From Device</b></td> <td>When the connected device is turned on/off, the projector will be activated/shut down, too.</td> </tr> </tbody> </table> </li> </ul>	<b>Bidirectional</b>	Turning on/off either the connected device or the projector can turn on/off both.	<b>From Projector</b>	When the projector is turned on/off, the connected device will be activated/shut down, too.	<b>From Device</b>	When the connected device is turned on/off, the projector will be activated/shut down, too.
<b>Bidirectional</b>	Turning on/off either the connected device or the projector can turn on/off both.						
<b>From Projector</b>	When the projector is turned on/off, the connected device will be activated/shut down, too.						
<b>From Device</b>	When the connected device is turned on/off, the projector will be activated/shut down, too.						
Baud Rate	Select a baud rate that is identical with your computer's so that you can connect the projector with a suitable RS-232 cable and update or download the projector's firmware. This function is intended for qualified service personnel.						
Test Pattern	Enable this function to display the grid test pattern, which helps you adjust the image size and focus so as to check if the projected image is free of distortion.						
Quick Cooling	Select <b>On</b> to shorten the projector cooling time from a normal 90-second duration to approximately 15 seconds.						

<p><b>High Altitude Mode</b></p>	<p>The mode is for operation in areas like high altitude or high temperature environments. Activate the function when your environment is between 1500 m –3000 m above sea level and ambient temperature is between 0°C–30°C.</p> <p> <b>Do not use this function if your altitude is between 0 m and 1500 m and ambient temperature is between 0°C and 35°C. If you turn on the mode under such a condition, the projector will be over cooled.</b></p> <p>Operation under <b>High Altitude Mode</b> may cause a higher decibel operating noise level because of increased fan speed necessary to improve overall system cooling and performance.</p> <p>If you use this projector under other extreme conditions excluding the above, it may display auto shut-down symptoms, which is designed to protect your projector from over-heating. In cases like this, you should switch to <b>High Altitude Mode</b> to solve these symptoms. However, this is not to state that this projector can operate under any and all harsh or extreme conditions.</p>
<p><b>Password</b></p>	<p>For security purposes and to prevent unauthorized use, you may set up password security for the projector. See <a href="#">Utilizing the password function</a> for details.</p> <ul style="list-style-type: none"> <li>• <b>Change Password</b> You will be asked to enter the current password before changing to a new one.</li> <li>• <b>Power On Lock</b> Limits use of the projector to only those who know the correct password.</li> </ul>
<p><b>Key Lock</b></p>	<p>With the control keys on the projector locked, you can prevent your projector settings from being changed accidentally (by children, for example).</p> <p>When you select <b>On</b> to enable this function, no control keys on the projector will function, except  <b>POWER</b>.</p> <p>To unlock the keys, press and hold  on the projector for 3 seconds.</p>
<p><b>LED Indicator</b></p>	<p>When you select <b>On</b>, all LED indicators on the projector function normally. See <a href="#">Indicators</a> for more details.</p> <p>When you select <b>Off</b>, the LED indicators (, , ) are off after you turn on the projector and the splash screen is displayed. However, if the projector is not working properly, the LED indicators light or flash to remind you that a problem may occur. See also <a href="#">Indicators</a> for more details.</p>
<p><b>Reset All Settings</b></p>	<p>Returns all settings to the factory preset values. The OSD menu type will return to the <b>Basic</b> OSD menu.</p> <p> <b>The following settings will still remain: Keystone, Language, Projector Position, Reset Lamp Timer, High Altitude Mode, Password, Key Lock, and ISF.</b></p>
<p><b>ISF</b></p>	<p>The ISF calibration menu is password protected and only accessible by authorized ISF calibrators. The ISF (Imaging Science Foundation) has developed carefully crafted, industry-recognized standards for optimal video performance and has implemented a training program for technicians and installers to use these standards to obtain optimal picture quality from BenQ video display devices. Accordingly, we recommend that setup and calibration be performed by an ISF certified installation technician.</p> <p> <b>For more information, go to <a href="http://www.imagingscience.com">www.imagingscience.com</a> or contact the dealer or retailer from whom you purchased the projector.</b></p>

## Information menu

Submenu	Functions and Descriptions
<b>Source</b>	Displays the current signal source.
<b>Picture Mode</b>	Displays the current picture mode under the <b>Picture</b> menu.
<b>Resolution</b>	Displays the native resolution of the input source.
<b>Color System</b>	Displays input system format.
<b>Lamp Usage Time</b>	Displays the number of hours the lamp has been used.
<b>3D Format</b>	Displays the current 3D mode. Only available when <b>3D Mode</b> is enabled.
<b>Firmware Version</b>	Displays the firmware version of your projector.

 Some information is given only when certain input sources are in use.

# Advanced OSD menu structure

The OSD menus vary according to the signal type selected.

Main menu	Submenu	Options	
Picture	Picture Mode	Bright/Vivid/Cinema/Game/Game (Bright)/User/3D/ISF Night/ISF Day	
	User Mode Management	Load Settings From Rename User Mode	
	Brightness	0-100	
	Contrast	0-100	
	Color	0-100	
	Tint	0-100	
	Sharpness	0-15	
	Color Temperature	Normal/Cool/Lamp Native/Warm	
	Lamp Power	Normal/Economic/SmartEco	
	Advanced...	Gamma Selection	1.6/1.8/2.0/2.1/2.2/2.3/2.4/2.6/2.8/BenQ
		Brilliant Color	On/Off
		Color Temperature Fine Tuning	Red Gain/Green Gain/Blue Gain/Red Offset/Green Offset/Blue Offset
		Color Management	Primary Color/Hue/Saturation/Gain
		Noise Reduction	0-31
		Fast Mode	On/Off
		Film Mode	On/Off
Reset Current Picture Mode	Reset/Cancel		
Audio Setup	Sound Mode	Effect Mode User EQ	
	Mute	On/Off	
	Volume	0-20	
	Power On/Off Ring Tone	On/Off	
	Reset Audio Settings	Reset/Cancel	
	Aspect Ratio	Auto/4:3/16:9/Wide/Letter Box	
Display	Wall Color	Off/Light Yellow/Pink/Light Green/Blue	
	Image Position		
	Overscan Adjustment	0/1/2/3	
	PC & Component YPbPr Tuning	H. Size	
		Phase	
		Auto	
	3D	3D Mode	Auto/3D Off/Frame Sequential/Frame Packing/Top-Bottom/Side-by-Side
3D Sync Invert		Invert	

<b>System Setup : Basic</b>	<b>Language</b>	English / Français / Deutsch / Italiano / Español / Русский / 繁體中文 / 简体中文 / 日本語 / 한국어 / Svenska / Nederlands / Türkçe / Čeština / Português / हिन्दी / Polski / Magyar / Hrvatski / Română / Norsk / Dansk / Български / Suomi / Indonesian / العربية / हिन्दी	
	<b>Background Color</b>	<b>Black/Blue/Purple</b>	
	<b>Splash Screen</b>	<b>BenQ/Black/Blue</b>	
	<b>Projector Position</b>	<b>Front/Front Ceiling/Rear/Rear Ceiling</b>	
	<b>Auto Off</b>	<b>Disable/5 min/10 min/15 min/20 min/25 min/30 min</b>	
	<b>Direct Power On</b>	<b>On/Off</b>	
	<b>Menu Settings</b>	<b>Menu Type</b>	<b>Basic/Advanced</b>
		<b>Menu Position</b>	<b>Center/Top-Left/Top-Right/Bottom-Right/Bottom-Left</b>
		<b>Menu Display Time</b>	<b>5 sec/10 sec/15 sec/20 sec/25 sec/30 sec/Always On</b>
		<b>Blank Reminder Message</b>	<b>On/Off</b>
	<b>Source Rename</b>		
	<b>Auto Source</b>	<b>On/Off</b>	
<b>System Setup : Advanced</b>	<b>Lamp Settings</b>	<b>Reset Lamp Timer</b>	<b>Reset/Cancel</b>
		<b>Lamp Timer</b>	
	<b>HDMI Settings</b>	<b>HDMI Range</b>	<b>Auto/Full/Limited</b>
		<b>CEC</b>	<b>On/Off</b>
		<b>Power On Link</b>	<b>Off/Bidirectional/From Projector/From Device</b>
		<b>Power Off Link</b>	<b>Off/Bidirectional/From Projector/From Device</b>
	<b>Baud Rate</b>	<b>9600/14400/19200/38400/57600/115200</b>	
	<b>Test Pattern</b>	<b>On/Off</b>	
	<b>Quick Cooling</b>	<b>On/Off</b>	
	<b>High Altitude Mode</b>	<b>On/Off</b>	
	<b>Password</b>	<b>Change Password</b>	
		<b>Power On Lock</b>	<b>On/Off (input current password)</b>
<b>Key Lock</b>	<b>On/Off</b>		
<b>LED Indicator</b>	<b>On/Off</b>		
<b>Reset All Settings</b>	<b>Reset/Cancel</b>		
<b>ISF</b>	<b>(input password)</b>		
<b>Information</b>	<b>Source</b>		
	<b>Picture Mode</b>		
	<b>Resolution</b>		
	<b>Color System</b>		
	<b>Lamp Usage Time</b>		
	<b>3D Format</b>		
<b>Firmware Version</b>			

# Maintenance

## Care of the projector

Your projector needs little maintenance. The only thing you have to do on a regular basis is keep the lens clean.

Never remove any parts of the projector except the lamp. Contact your dealer or local customer service center if the projector fails to operate as expected.

### Cleaning the lens

Clean the lens whenever you notice dirt or dust on the surface.

Before cleaning any part of the projector, turn it off using the proper shutdown procedure (see [Shutting down the projector](#)), unplug the power cable, and let it cool down completely.

- Use a canister of compressed air to remove dust.
- If there is dirt or smears, use lens-cleaning paper or moisten a soft cloth with lens cleaner and gently wipe the lens surface.
- Never use any type of abrasive pad, alkaline/acid cleaner, scouring powder, or volatile solvent, such as alcohol, benzene, thinner or insecticide. Using such materials or maintaining prolonged contact with rubber or vinyl materials may result in damage to the projector surface and cabinet material.

 **Never touch the lens with your finger or rub the lens with abrasive materials. Even paper towels can damage the lens coating. Only ever use a proper photographic lens brush, cloth, and cleaning solution. Do not attempt to clean the lens while the projector is switched on or is still hot from previous use.**

### Cleaning the projector case

Before cleaning any part of the projector, turn it off using the proper shutdown procedure (see [Shutting down the projector](#)), unplug the power cable, and let it cool down completely.

- To remove dirt or dust, wipe the case with a soft, dry, lint-free cloth.
- To remove stubborn dirt or stains, moisten a soft cloth with water and a neutral detergent. Then wipe the case.

 **Never use wax, alcohol, benzene, thinner or other chemical detergents. These can damage the case.**

### Storing the projector

To store the projector for an extended time:

- Make sure the temperature and humidity of the storage area are within the recommended range for the projector. Refer to [Specifications](#) or consult your dealer about the range.
- Retract the adjuster feet.
- Remove the batteries from the remote control.
- Pack the projector in its original packing or equivalent.

### Transporting the projector

It is recommended that you ship the projector with its original packing or equivalent.

# Lamp information

## Getting to know the lamp hour

When the projector is in operation, the duration (in hours) of lamp usage is automatically calculated by the built-in timer.

Total (equivalent) lamp hour = 2.0 x (hours used in **Normal** mode) + 1.4 x (hours used in **Economic** mode) + 1.0 x (hours used in **SmartEco** mode)

To obtain the lamp hour information:

1. Press **MENU** and then use the arrow keys (◀/▶/▲/▼) to go to **Information** (while under the **Basic** OSD menu) or **Settings > Information** (while under the **Advanced** OSD menu).
2. The **Lamp Usage Time** information is displayed.
3. Press **BACK** to exit.

or

1. Under the **Advanced** OSD menu, press **MENU** and then use the arrow keys (◀/▶/▲/▼) to go to **System Setup : Advanced > Lamp Settings**.
2. Press **OK** to display the **Lamp Settings** window.
3. Use ▼ to select **Lamp Timer** and press **OK**, the **Lamp Timer** information is displayed.
4. Press **BACK** to exit.

## Extending lamp life

The projection lamp is a consumable item. To keep the lamp life as long as possible, you can do the following settings via the **Advanced** OSD menu.

To access the **Advanced** OSD menu, see 25 for details.

## Setting Lamp Power

Setting the projector in **Economic** or **SmartEco** mode extends the lamp life.

Lamp mode	Description
<b>Normal</b>	100% lamp brightness
<b>Economic</b>	Saves 30% lamp power consumption
<b>SmartEco</b>	Saves up to 70% lamp power consumption depending on the content brightness level

Using **Economic** mode reduces system noise and power consumption by 30%. Using **SmartEco** mode reduces system noise and lamp power consumption by up to 70%. If the **Economic** or **SmartEco** mode is selected, the light output will be reduced and result in darker projected pictures.

1. Under the **Advanced** OSD menu, go to **Picture > Lamp Power**.
2. Press **OK** to display the **Lamp Power** window.
3. Press ▲/▼ to move to your desired mode, and press **OK** to save your changes and exit.



## Setting Auto Off

This function allows the projector to turn off automatically if no input source is detected after a set period of time.

1. Under the **Advanced** OSD menu, go to **System Setup : Basic > Auto Off**.
2. Press **◀/▶** to select a time period. If the preset time lengths are not suitable for your presentation, select **Disable**, and the projector will not automatically shut down in a certain time period.
3. When done, press **BACK** to save your changes and exit.

## Timing of replacing the lamp

When the Lamp indicator lights up red or a message appears suggesting it is time to replace the lamp, please install a new lamp or consult your dealer. An old lamp may cause a malfunction in the projector and in some instances the lamp may explode. Go to <http://www.BenQ.com> for how to purchase a replacement lamp.

The LAMP indicator light and TEMP warning light will light up if the lamp becomes too hot. Turn the power off and let the projector cool for 45 minutes. If the LAMP or TEMP indicator still lights up after turning the power back on, please contact your dealer. See [Indicators](#) for details.

Please replace the lamp when the following lamp warning messages appear:

**The illustrations show the examples of messages you will see under the Basic menu. They are for reference only and may differ from the actual design and the menu type you've selected.**

Status	Message
<p>Install a new lamp for optimal performance. If the projector operates normally in <b>Economic</b> mode (see <a href="#">Getting to know the lamp hour</a>), you may continue operating the projector until the next lamp warning appears.</p> <p>Press <b>OK</b> to dismiss the message.</p>	<p><b>Order Replacement Lamp</b> Lamp&gt;XXXX Hours Order a new lamp at <a href="http://www.benq.com">www.benq.com</a> <b>OK</b></p>
<p>We strongly recommend you to replace the lamp at this stage. The lamp is a consumable item. The lamp brightness diminishes with use. This is normal lamp behavior. You can replace the lamp whenever you notice that the brightness level has significantly diminished.</p> <p>Press <b>OK</b> to dismiss the message.</p>	<p><b>Replace Lamp soon</b> Lamp&gt;XXXX Hours Order a new lamp at <a href="http://www.benq.com">www.benq.com</a> <b>OK</b></p>
<p>The lamp <b>MUST</b> be replaced before the projector will operate normally.</p> <p>Press <b>OK</b> to dismiss the message.</p>	<p><b>Replace Lamp Now</b> Lamp&gt;XXXX Hours Order a new lamp at <a href="http://www.benq.com">www.benq.com</a> Lamp usage time exceeded <b>OK</b></p>
<p>The lamp <b>MUST</b> be replaced before the projector will operate normally.</p> <p>Press <b>OK</b> to dismiss the message.</p>	<p><b>Out of Lamp Usage Time</b> Replace lamp (Refer to user manual) Then reset lamp timer Order a new lamp at <a href="http://www.benq.com">www.benq.com</a> <b>OK</b></p>

**The "XXXX" shown in the above messages are numbers that vary depending on different models.**

# Replacing the lamp

- ⚠ • **To reduce the risk of electrical shock, always turn the projector off and disconnect the power cable before changing the lamp.**
- **To reduce the risk of severe burns, allow the projector to cool for at least 45 minutes before replacing the lamp.**
- **To reduce the risk of injuries to fingers and damage to internal components, use caution when removing lamp glass that has shattered into sharp pieces.**
- **To reduce the risk of injuries to fingers and/or compromising image quality by touching the lens, do not touch the empty lamp compartment when the lamp is removed.**
- **This lamp contains mercury. Consult your local hazardous waste regulations to dispose of this lamp in a proper manner.**
- **To assure optimal performance from the projector, it is recommended that you purchase a qualified projector lamp for lamp replacement.**
- **If lamp replacement is performed while the projector is suspended upside-down from the ceiling, make sure that no one is underneath the lamp socket to avoid any possible injury or damage to the human eyes caused by fractured lamp.**
- **Ensure good ventilation when handling broken lamps. We recommend that you use respirators, safety glasses, goggles or face shield and wear protective clothing such as gloves.**

1. Turn the power off and disconnect the projector from the power outlet. If the lamp is hot, avoid burns by waiting for approximately 45 minutes until the lamp has cooled.
2. Loosen the screws that secure the lamp cover on the top of the projector until the lamp cover loosens.

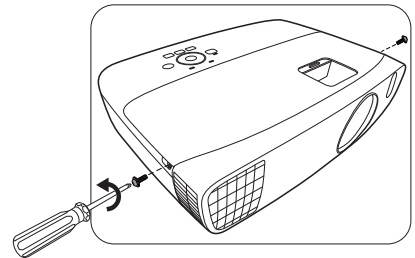

3. Remove the lamp cover from the projector.
4. Confirm a position of the lamp protection film to put a new film on the same position later, then remove and dispose of the lamp protection film.

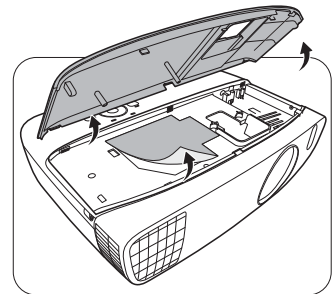

- ⚠ • **Do not turn the power on with the lamp cover removed.**
- **Do not insert your fingers between the lamp and the projector as the sharp edges inside the projector may cause injuries.**

5. Disconnect the lamp connector from the projector as illustrated.
6. Loosen the screw that secures the lamp.
7. Lift the handle so that it stands up.

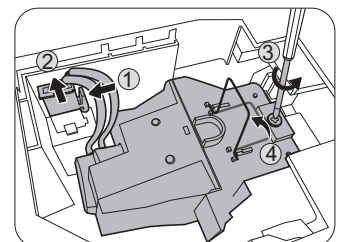

8. Use the handle to slowly pull the lamp out of the projector.



- **Pulling it too quickly may cause the lamp to break and scatter broken glass in the projector.**
- **Do not place the lamp in locations where water might splash on it, children can reach it, or near flammable materials.**
- **Do not insert your hands into the projector after the lamp is removed. If you touch the optical components inside, it could cause color unevenness and distortion of the projected images.**

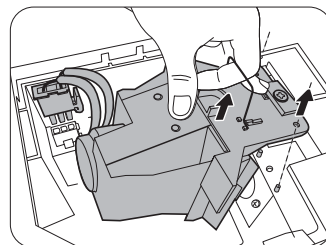

9. As shown in the illustration, lower the new lamp.

10. Reconnect the lamp connector.

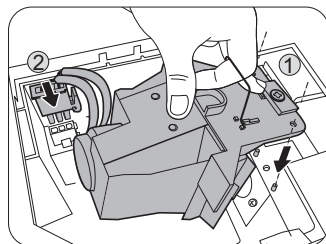

11. Tighten the screw that secures the lamp.

12. Ensure the handle is fully laid flat and locked in place.



- **Loose screws may cause a bad connection, which could result in malfunction.**
- **Do not over tighten the screw.**

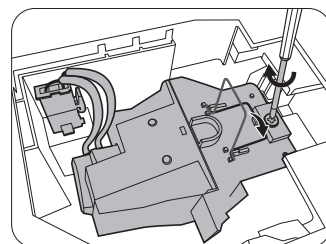

13. Replace the lamp cover on the projector.

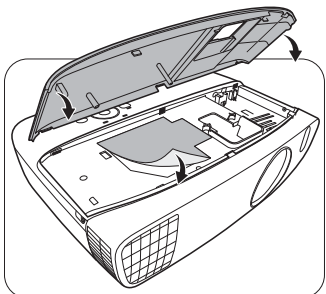

14. Tighten the screws that secure the lamp cover.



- **Loose screws may cause a bad connection, which could result in malfunction.**
- **Do not over tighten the screw.**

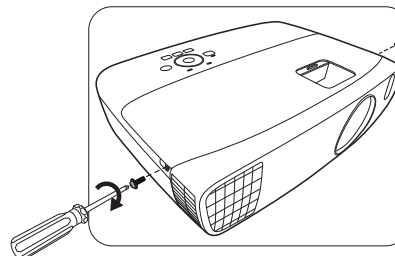

15. Connect the power and restart the projector.

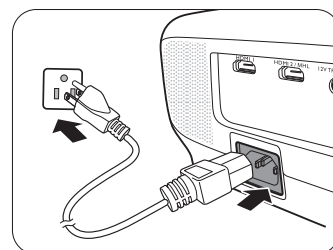

16. After the startup logo is displayed, reset the lamp timer via the OSD menu.

- Under the **Advanced** OSD menu, go to **System Setup : Advanced > Lamp Settings > Reset Lamp Timer**, and select **Reset**.
- Under the **Basic** OSD menu, if there's no signal connected to the projector, go to **Reset Lamp Timer** and select **Reset**; if there are signals connected, go to **Settings > Reset Lamp Timer**, and select **Reset**.



**Do not reset if the lamp is not new or replaced as this could cause damage.**

A "**Reset Successfully**" message is displayed to notify that the lamp time has been reset to "0".

## Indicators

There are three indicators which show the status of the projector. Check the following information about the indicator lights. If there is anything wrong, turn the projector off and contact your dealer.

Light			Status & Description
POWER 	TEMP 	LAMP 	
<b>Power events</b>			
<b>Orange</b>	<b>Off</b>	<b>Off</b>	Stand-by mode
<b>Green Flashing</b>	<b>Off</b>	<b>Off</b>	Powering up
<b>Green</b>	<b>Off</b>	<b>Off</b>	Normal operation
<b>Orange Flashing</b>	<b>Off</b>	<b>Off</b>	Normal power-down cooling
<b>Red Flashing</b>	<b>Red Flashing</b>	<b>Red Flashing</b>	Downloading
<b>Green</b>	<b>Off</b>	<b>Red</b>	CW start fail
<b>Red</b>	<b>Off</b>	<b>Red</b>	Scaler reset fail
<b>Green</b>	<b>Off</b>	<b>Off</b>	Burn-in ON
<b>Green</b>	<b>Green</b>	<b>Green</b>	Burn-in OFF
<b>Lamp events</b>			
<b>Off</b>	<b>Off</b>	<b>Red</b>	Lamp I error in normal operation
<b>Off</b>	<b>Off</b>	<b>Red Flashing</b>	Lamp is not lit up
<b>Thermal events</b>			
<b>Red</b>	<b>Red</b>	<b>Off</b>	Fan 1 error (the actual fan speed is $\pm 25\%$ outside the desired speed)
<b>Red</b>	<b>Red Flashing</b>	<b>Off</b>	Fan 2 error (the actual fan speed is $\pm 25\%$ outside the desired speed)
<b>Red</b>	<b>Green</b>	<b>Off</b>	Fan 3 error (the actual fan speed is $\pm 25\%$ outside the desired speed)

<b>Red</b>	<b>Green Flashing</b>	<b>Off</b>	Fan 4 error (the actual fan speed is $\pm 25\%$ outside the desired speed)
<b>Red Flashing</b>	<b>Red</b>	<b>Off</b>	Fan 5 error (the actual fan speed is $\pm 25\%$ outside the desired speed)
<b>Red Flashing</b>	<b>Red Flashing</b>	<b>Off</b>	Fan 6 error (the actual fan speed is $\pm 25\%$ outside the desired speed)
<b>Red Flashing</b>	<b>Green</b>	<b>Off</b>	Fan 7 error (the actual fan speed is $\pm 25\%$ outside the desired speed)
<b>Red Flashing</b>	<b>Green Flashing</b>	<b>Off</b>	Fan 8 error (the actual fan speed is $\pm 25\%$ outside the desired speed)
<b>Green</b>	<b>Red</b>	<b>Off</b>	Temperature 1 error (over limited temperature)
<b>Green</b>	<b>Red Flashing</b>	<b>Off</b>	Thermal sensor 1 open error
<b>Green</b>	<b>Green</b>	<b>Off</b>	Thermal sensor 1 short error
<b>Green</b>	<b>Green Flashing</b>	<b>Off</b>	Thermal IC#1 I2C error connection error
<b>Green Flashing</b>	<b>Red</b>	<b>Off</b>	Temperature 2 error (over limited temperature)
<b>Green Flashing</b>	<b>Red Flashing</b>	<b>Off</b>	Thermal Sensor 2 open error
<b>Green Flashing</b>	<b>Green</b>	<b>Off</b>	Thermal Sensor 2 short error
<b>Green Flashing</b>	<b>Green Flashing</b>	<b>Off</b>	Thermal IC #2 I2C connection error

# Troubleshooting

Problem	Cause	Remedy
The projector does not turn on.	There is no power from the power cable.	Plug the power cable into the AC inlet on the rear of the projector, and plug the power cable into to the power outlet. If the power outlet has a switch, make sure that it is switched on.
	Attempting to turn the projector on again during the cooling process.	Wait until the cooling down process has completed.
	The lamp cover is not securely attached.	Correctly attach the lamp cover.
No picture.	The video source is not turned on or connected correctly.	Turn the video source on and check that the signal cable is connected correctly.
	The projector is not correctly connected to the input source device.	Check the connection.
	The input source has not been correctly selected.	Select the correct source with the <b>SOURCE</b> key on the projector or remote control.
Image is unstable.	The connection cables are not securely connected to the projector or the signal source.	Correctly connect the cables to the appropriate terminals.
Picture is blurred.	The projection lens is not correctly focused.	Adjust the focus of the lens using the focus ring.
	The projector and the screen are not aligned properly.	Adjust the projection angle and direction as well as the height of this projector if necessary.
	The lens cover is still closed.	Remove the lens cover.
Remote control does not work correctly.	The batteries are out of power.	Replace both of the batteries with new ones.
	There is an obstacle between the remote control and the projector.	Remove the obstacle.
	You are too far away from the projector.	Stand within 8 meters (26.2 feet) of the projector.
3D content does not display correctly	The 3D glasses are out of battery.	Recharge the 3D glasses.
	The settings in the <b>3D</b> menu are not set correctly.	Correctly set the settings in the <b>3D</b> menu.
	Your Blu-ray Disc is not in 3D format.	Use a 3D Blu-ray Disc and try again.
	The input source has not been correctly selected.	Select the correct source with the <b>SOURCE</b> key on the projector or remote control.

# Specifications

## Projector specifications

 All specifications are subject to change without notice.

### Optical

Resolution  
1920 (H) x 1080 (V)

Display system  
Single-chip DLP™ system

Lens F/Number  
F = 2.6 to 2.78, f = 10.2 to 12.24 mm

Lamp  
240 W lamp

### Electrical

Power supply  
AC100–240V, 4.0 A, 50-60 Hz (Automatic)

Power consumption  
375 W (Max); < 0.5 W (Standby)

### Mechanical

Weight  
3.6 Kg (7.94 lbs)

### Output terminals

Speaker  
(Stereo) 5 watt x 2

Audio signal output  
PC audio jack x 1

### Control

RS-232 serial control  
9 pin x 1

IR receiver x 2

12VDC (Max. 0.5 A) x 1

### Input terminals

Computer input  
RGB input  
D-Sub 15-pin (female) x 1

Video signal input  
SD/HDTV signal input  
Digital - HDMI x 1; HDMI/MHL x 1

Audio signal input  
Audio in  
PC audio jack x 1

USB port (Type-A x 1; Mini-B x 1)

### Environmental Requirements

Operating temperature  
0°C–40°C at sea level

Operating relative humidity  
10%–90% (without condensation)

Operating altitude  
0–1499 m at 0°C–35°C  
1500–3000 m at 0°C–30°C (with  
High Altitude Mode on)

## Dimensions

380.5 mm x 277 mm x 121.7 mm (W x D x H)

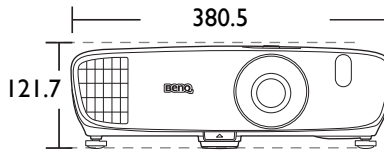
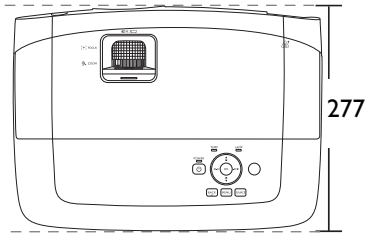

Unit: mm

## Ceiling mount installation

- ⊙ Ceiling mount screws: M4  
(Max. L = 25 mm; Min. L = 20 mm)

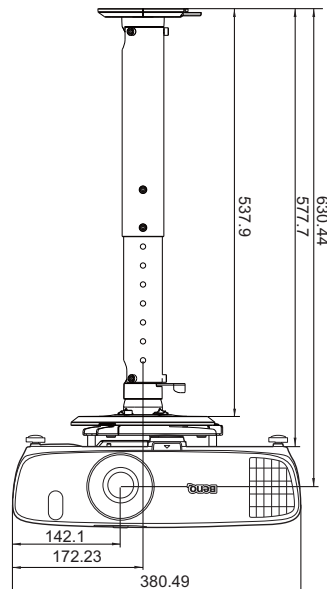
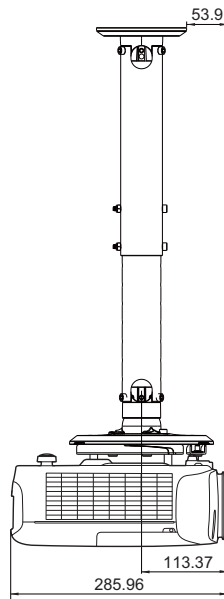
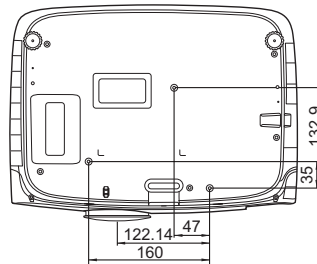

Unit: mm



# Timing chart

## Supported timing for PC input

Format	Resolution	Refresh rate (Hz)	H. Frequency (KHz)	Pixel Frequency (MHz)
720 x 400	720 x 400_70	70.087	31.469	28.3221
640 x 480	VGA_60*	59.940	31.469	25.175
	VGA_72	72.809	37.861	31.500
	VGA_75	75.000	37.500	31.500
	VGA_85	85.008	43.269	36.000
800 x 600	SVGA_60*	60.317	37.879	40.000
	SVGA_72	72.188	48.077	50.000
	SVGA_75	75.000	46.875	49.500
	SVGA_85	85.061	53.674	56.250
	SVGA_120** (Reduce Blanking)	119.854	77.425	83.000
1024 x 768	XGA_60*	60.004	48.363	65.000
	XGA_70	70.069	56.476	75.000
	XGA_75	75.029	60.023	78.750
	XGA_85	84.997	68.667	94.500
	XGA_120** (Reduce Blanking)	119.989	97.551	115.500
1152 x 864	1152 x 864_75	75.00	67.500	108.000
1024 x 576	BenQ Notebook Timing	60.0	35.820	46.966
1024 x 600	BenQ Notebook Timing	64.995	41.467	51.419
1280 x 720	1280 x 720_60*	60	45.000	74.250
1280 x 768	1280 x 768_60*	59.870	47.776	79.5
1280 x 800	WXGA_60*	59.810	49.702	83.500
	WXGA_75	74.934	62.795	106.500
	WXGA_85	84.880	71.554	122.500
	WXGA_120** (Reduce Blanking)	119.909	101.563	146.25

1280 x 1024	SXGA_60***	60.020	63.981	108.000
	SXGA_75	75.025	79.976	135.000
	SXGA_85	85.024	91.146	157.500
1280 x 960	1280 x 960_60***	60.000	60.000	108
	1280 x 960_85	85.002	85.938	148.500
1360 x 768	1360 x 768_60***	60.015	47.712	85.500
1440 x 900	WXGA+_60***	59.887	55.935	106.500
1400 x 1050	SXGA+_60***	59.978	65.317	121.750
1600 x 1200	UXGA***	60.000	75.000	162.000
1680 x 1050	1680 x 1050_60***	59.954	65.290	146.250
640 x 480@67Hz	MAC13	66.667	35.000	30.240
832 x 624@75Hz	MAC16	74.546	49.722	57.280
1024 x 768@75Hz	MAC19	74.93	60.241	80.000
1152 x 870@75Hz	MAC21	75.06	68.68	100.00

 **\*Supported timing for 3D signal with Frame Sequential, Top-Bottom and Side-by-Side format.**

**\*\*Supported timing for 3D signal with Frame Sequential format.**

**\*\*\*Supported timing for 3D signal with Top-Bottom and Side-by-Side format.**

 **The timings showing above may not be supported due to EDID file and VGA graphic card limitations. It is possible that some timings cannot be chosen.**

## Supported timing for HDMI (HDCP) input

Format	Resolution	Refresh rate (Hz)	H. Frequency (KHz)	Pixel Frequency (MHz)
640 x 480	VGA_60*	59.940	31.469	25.175
	VGA_72	72.809	37.861	31.500
	VGA_75	75.000	37.500	31.500
	VGA_85	85.008	43.269	36.000
720 x 400	720 x 400_70	70.087	31.469	28.3221
800 x 600	SVGA_60*	60.317	37.879	40.000
	SVGA_72	72.188	48.077	50.000
	SVGA_75	75.000	46.875	49.500
	SVGA_85	85.061	53.674	56.250
	SVGA_120** (Reduce Blanking)	119.854	77.425	83.000
1024 x 768	XGA_60*	60.004	48.363	65.000
	XGA_70	70.069	56.476	75.000
	XGA_75	75.029	60.023	78.750
	XGA_85	84.997	68.667	94.500
	XGA_120** (Reduce Blanking)	119.989	97.551	115.500
1152 x 864	1152 x 864_75	75.00	67.500	108.000
1024 x 576	BenQ Notebook Timing	60.00	35.820	46.996
1024 x 600	BenQ Notebook Timing	64.995	41.467	51.419
1280 x 720	1280 x 720_60*	60	45.000	74.250
1280 x 768	1280 x 768_60*	59.870	47.776	79.5
1280 x 800	WXGA_60*	59.810	49.702	83.500
	WXGA_75	74.934	62.795	106.500
	WXGA_85	84.880	71.554	122.500
	WXGA_120** (Reduce Blanking)	119.909	101.563	146.25
1280 x 1024	SXGA_60***	60.020	63.981	108.000
	SXGA_75	75.025	79.976	135.000
	SXGA_85	85.024	91.146	157.500

1280 x 960	1280 x 960_60***	60.000	60.000	108
	1280 x 960_85	85.002	85.938	148.500
1360 x 768	1360 x 768_60***	60.015	47.712	85.500
1440 x 900	WXGA+_60***	59.887	55.935	106.500
1400 x 1050	SXGA+_60***	59.978	65.317	121.750
1600 x 1200	UXGA***	60.000	75.000	162.000
1680 x 1050	1680 x 1050_60***	59.954	65.290	146.250
640 x 480@67Hz	MAC13	66.667	35.000	30.240
832 x 624@75Hz	MAC16	74.546	49.722	57.280
1024 x 768@75Hz	MAC19	75.020	60.241	80.000
1152 x 870@75Hz	MAC21	75.06	68.68	100.00
1920 x 1080@60Hz	1920 x 1080_60 (Reduce Blanking)	60	67.5	148.5
1920 x 1200@60Hz	1920 x 1200_60 (Reduce Blanking)	59.95	74.038	154

 **\*Supported timing for 3D signal with Frame Sequential, Top-Bottom and Side-by-Side format.**

**\*\*Supported timing for 3D signal with Frame Sequential format.**

**\*\*\*Supported timing for 3D signal with Top-Bottom and Side-by-Side format.**

 **The timings showing above may not be supported due to EDID file and VGA graphic card limitations. It is possible that some timings cannot be chosen.**

Timing	Resolution	Vertical Frequency (Hz)	Horizontal Frequency (KHz)	Pixel Frequency (MHz)	Remark
480i****	720 (1440) x 480	59.94	15.73	27	HDMI only
480p****	720 x 480	59.94	31.47	27	HDMI only
576i	720 (1440) x 576	50	15.63	27	HDMI/DVI
576p	720 x 576	50	31.25	27	HDMI/DVI
720/50p**	1280 x 720	50	37.5	74.25	HDMI/DVI
720/60p*	1280 x 720	60	45.00	74.25	HDMI/DVI
1080/24P**	1920 x 1080	24	27	74.25	HDMI/DVI
1080/25P	1920 x 1080	25	28.13	74.25	HDMI/DVI
1080/30P	1920 x 1080	30	33.75	74.25	HDMI/DVI
1080/50i*****	1920 x 1080	50	28.13	74.25	HDMI/DVI
1080/60i*****	1920 x 1080	60	33.75	74.25	HDMI/DVI
1080/50P***	1920 x 1080	50	56.25	148.5	HDMI/DVI
1080/60P***	1920 x 1080	60	67.5	148.5	HDMI/DVI



**\*Supported timing for 3D signal with Frame Packing, Top-Bottom format, Side-by-Side, and Frame Sequential format.**

**\*\*Supported timing for 3D signal with Frame Packing, Top-Bottom format, and Side-by-Side format.**

**\*\*\*Supported timing for 3D signal with Top-Bottom and Side-by-Side format.**

**\*\*\*\*Supported timing for 3D signal with Frame Sequential format.**

**\*\*\*\*\*Supported timing for 3D signal with Side-by-Side format.**

# Warranty and Copyright information

## Warranty

BenQ warrants this product against any defects in material and workmanship, under normal usage and storage.

Proof of purchase date will be required with any warranty claim. In the event this product is found to be defective within the warranty period, BenQ's only obligation and your exclusive remedy shall be replacement of any defective parts (labor included). To obtain warranty service, immediately notify the dealer from which you purchased the product of any defects.

Important: The above warranty shall be void if the customer fails to operate the product in accordance with BenQ's written instructions, especially the ambient humidity must be in-between 10% and 90%, temperature in-between 0°C and 35°C, altitude lower than 3000 meters, and avoiding to operate the projector in a dusty environment. This warranty gives you specific legal rights, and you may have other rights which vary from country to country.

For other information, please visit [www.BenQ.com](http://www.BenQ.com).

## Copyright

Copyright © 2016 by BenQ Corporation. All rights reserved. No part of this publication may be reproduced, transmitted, transcribed, stored in a retrieval system or translated into any language or computer language, in any form or by any means, electronic, mechanical, magnetic, optical, chemical, manual or otherwise, without the prior written permission of BenQ Corporation.

All trademarks and registered trademarks are the property of their respective owners.

## Disclaimer

BenQ Corporation makes no representations or warranties, either expressed or implied, with respect to the contents hereof and specifically disclaims any warranties, merchantability or fitness for any particular purpose. Further, BenQ Corporation reserves the right to revise this publication and to make changes from time to time in the contents hereof without obligation of BenQ Corporation to notify any person of such revision or changes.